



**SOUTHERN ELEVATOR
& ELECTRIC SUPPLY**



Always Smooth Sailing

ISO 9001:2015



SOUTHERN ELEVATOR
& ELECTRIC SUPPLY

MOD PACKAGES NOW!

- » **Fast Delivery
Rush Available**
- » **Bundle 3 or more of your
modernization packages
with SEES and get
FREE GROUND FREIGHT!***
- » **Call your SEES Sales
Manager for more details**

**Subject to change*



TABLE OF «
Contents

Fixtures 2-9
313-359

Power Units 10-11
376-378

***SmartRise
Controllers*** 12-13
218-219

***GAL
Door Operators*** 15
612-613

Doors 16-19
243-246

» SEES FIXTURES



CONTACT US «

By Phone:
(800) 526-0026
(954) 971-1115

By Fax:
(954) 917-7337

By Mail:
2781 W. McNab Rd.
Pompano Beach, FL 33069



About SEES

SEES was founded in 1977 by Richard and Verne Fitzgerald. Richard brought ten years experience in elevator service and construction to the business. Together, they built SEES into the largest independent manufacturer and supplier of replacement parts in the USA. In 2008, Ningbo SEES, our branch in Ningbo, China was established.

SEES has earned the reputation of being the company that offers the best solutions to all industry demands over the last forty years. We are now extending our innovation and superior quality trademark to the world of elevator fixtures.

Our mission is to be the leading elevator parts company in the world by dedicating our resources, talent and energy to help improve the elevator industry.

Always Smooth Sailing

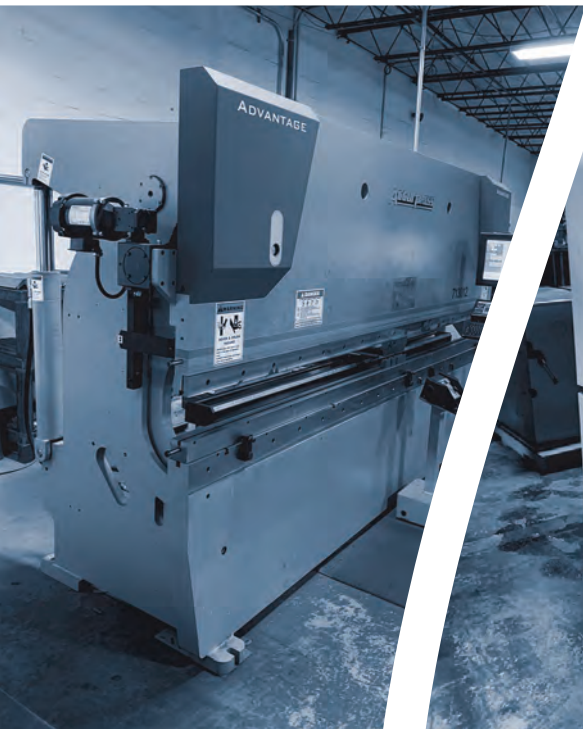

MADE IN THE U.S.A.

SEES fixtures are produced at the SEES global headquarters in Pompano Beach, FL. As an ISO 9001 Certified Manufacturer, SEES utilizes lean manufacturing techniques and advanced technology to produce top quality products. SEES state of the art machining capabilities allow high-volume parts production as well as the ability for quick turn around times on custom and short run manufacturing. Contact SEES with confidence.

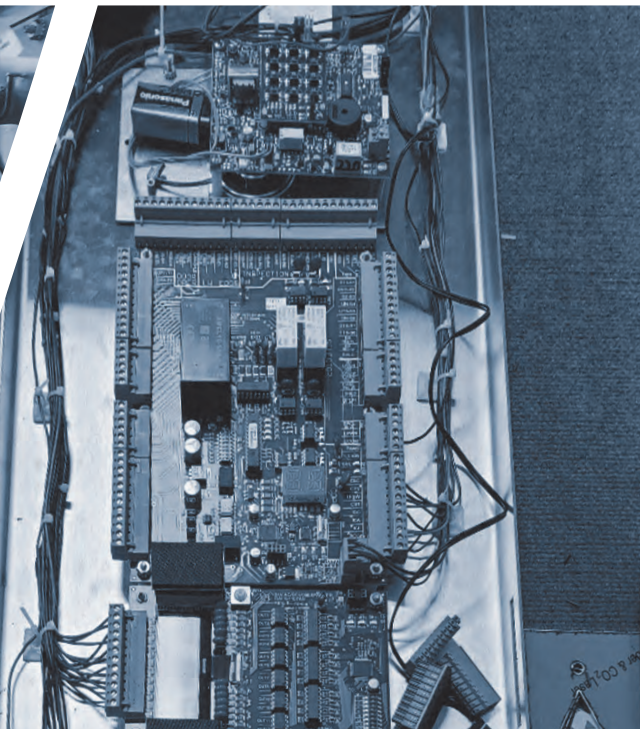
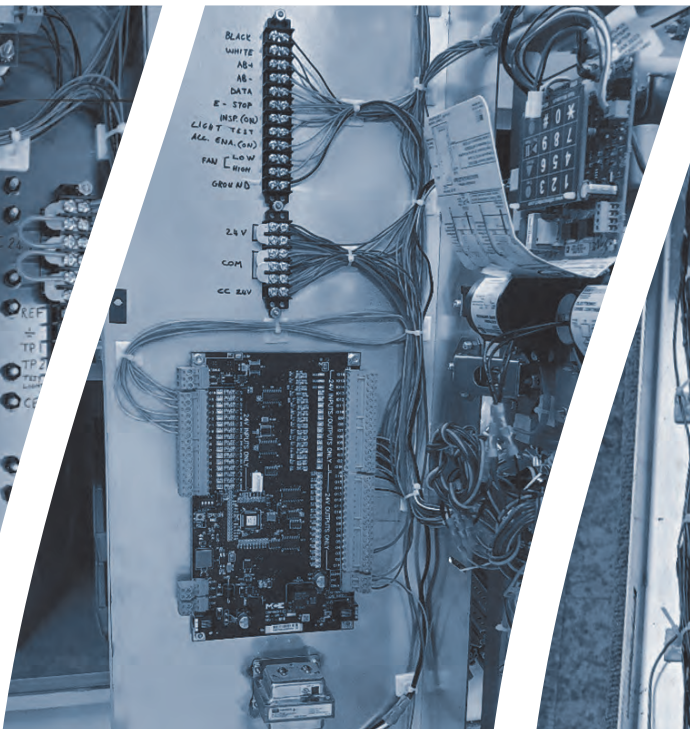
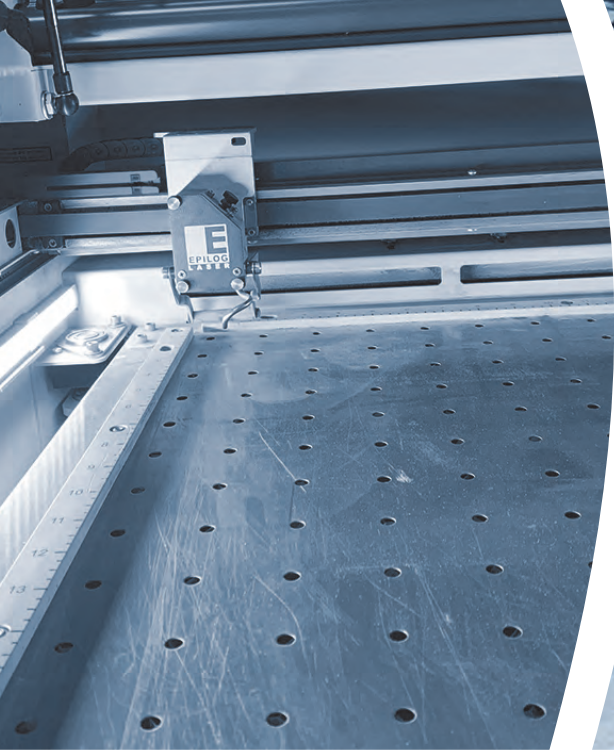

**SOUTHERN ELEVATOR
& ELECTRIC SUPPLY**

Always Smooth Sailing



» **SEES Vandal Resistant Push Buttons**

Created for situations where 'standard' or 'typical' just won't do. SEES push buttons add class and durability to your fixtures. The SEES Rhino Series provides vandal resistance, ensuring long-lasting functionality. Multi-volt options are available: 24 - 120 AC/DC.

» **SEES-PB30-SERIES**

Flat, center dot illumination, 24V

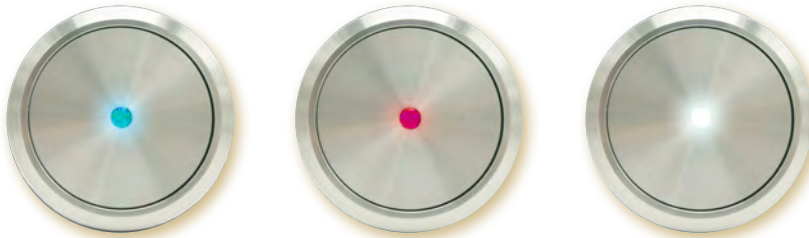

» **BRILLE OPTIONS**



Crescent
Stainless Marking

» **SEES-PB10-SERIES**

Flat, halo illumination, 24V

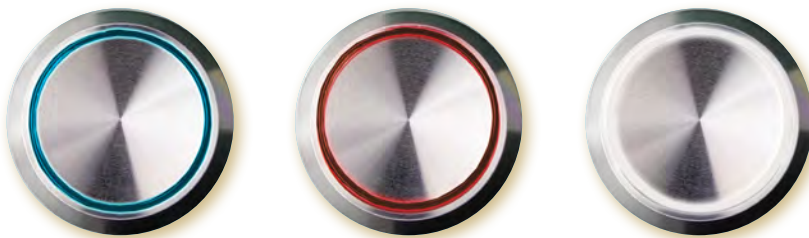

Round
Stainless Marking

» **SEES-PB-30M**

Convex, dot and halo illumination (Multi-Volt)



Square
Stainless Marking

» Additional Button Options

» SEES-PB510S-SERIES

Illuminating halo and characters



» SEES-PB129-SERIES

Illuminating halo and characters



» SEES-PB-22J-B

Polished concave button with illuminating halo



» COMBINATION OF BUTTONS, BRAILLE AND TACTILE

Center dot illumination and halo illumination



» SEES-PBR-FRR-SERIES

Illuminating halo and characters



» Hall Operating Panels

SEES Hall Stations provide value and style to match the elegant finish of our COP's. Our flush mounted series provides a seamless look to any existing lobby or floor design. Our surface mounted series provides an ease of installation to combat any specific challenges due to existing installation conditions.



Flush Mount Terminal

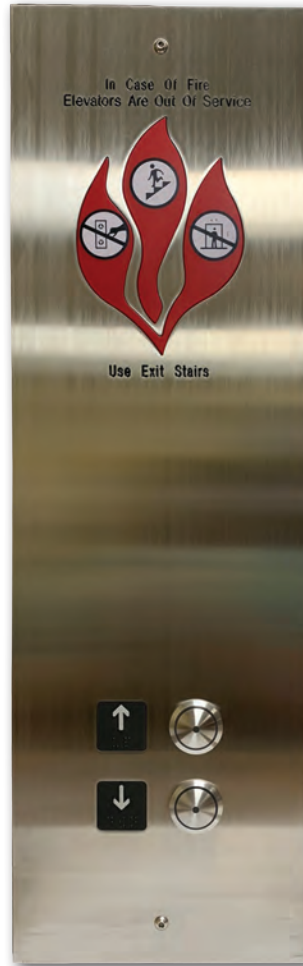

Flush Mount Intermediate



Surface Mount Terminal

» Car Operating Panels

With a smart, simple look, our Brushed Stainless Steel Car Operating Panels are an upgrade to any elevator cab. Using Vandal Resistant buttons and premium quality components, our COP's have a trusted look and feel. Whether it is an applied panel or a swing type, our COP's are a reliable option to fit in any cab. Plus, with a variety of buttons, key switches and fire service cabinet options, any modernization project is ensured to be a success.



MOD PACKAGES

» *Hall / Car Lanterns / Position Indicators*

With multiple options, SEES Hall & Car Lanterns are customizable to compliment any building design. Combined with our various position indicator options, we can also transform a standard hall lantern into a unique and elegant display. With our ISO 9001: 2015 certification, SEES certified standard will comply with any building or elevator code.



Horizontal Surface Mount with Digital PI

Vertical Surface Mount

SEES-FCLS-FM-002

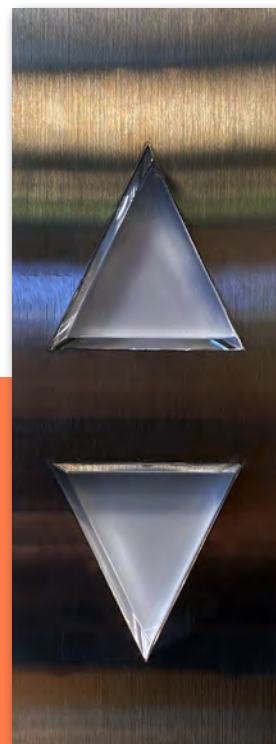

Vertical Flush Mount

SEES-FCLS-FM-003

» In-stock Hall Stations

Economically priced and ready to ship!

LOW PROFILE SURFACE MOUNT

- SEES-FHOP-SMT-001TB** Terminal Hall Station (12-1/4" x 4" x 7/8"), Blue LED, Vandal Resistant Button
- SEES-FHOP-SMT-001TR** Terminal Hall Station (12-1/4" x 4" x 7/8"), Red LED Vandal Resistant Button
- SEES-FHOP-SMT-001TW** Terminal Hall Station (12-1/4" x 4" x 7/8"), White LED, Vandal Resistant Button
- SEES-FHOP-SMI-001TB** Intermediate Hall Station (12-1/4" x 4" x 7/8"), Blue LED, Vandal Resistant Buttons
- SEES-FHOP-SMI-001TR** Intermediate Hall Station (12-1/4" x 4" x 7/8"), Red LED, Vandal Resistant Buttons
- SEES-FHOP-SMI-001TW** Intermediate Hall Station (12-1/4" x 4" x 7/8"), White LED, Vandal Resistant Buttons

SEES-FHOP-SMT-001TR

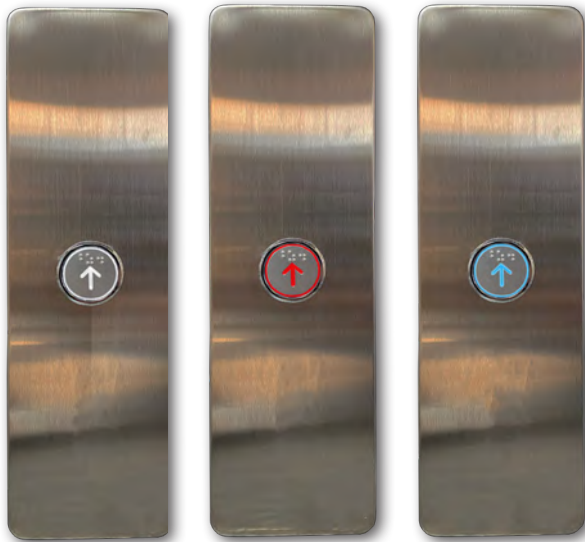

SEES-FHOP-SMT-001TR



SEES-FHOP-SMT-001TW

SEES-FHOP-SMT-001TB

SEES-FHOP-SMT-001TW

SEES-FHOP-SMT-001TB

SEES-FHOP-SMI-001TR

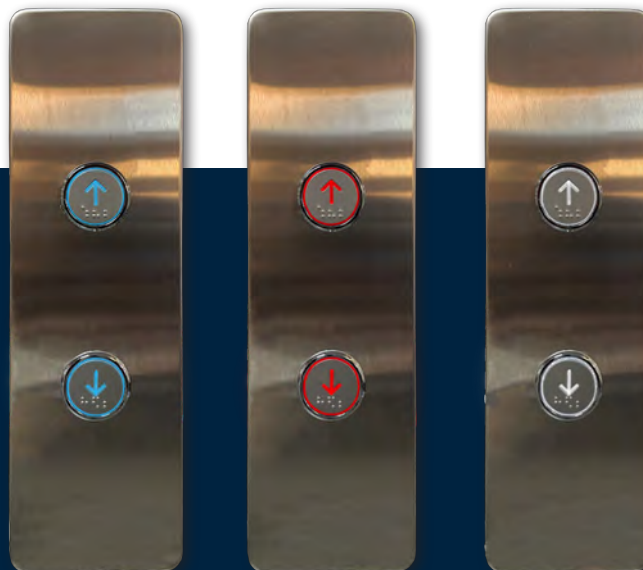

SEES-FHOP-SMI-001TB

SEES-FHOP-SMI-001TW

» SEES Modernization Equipment. Fast and Economical.

SEES offers the products you need for a timely Elevator Modernization. We have hydraulic power units available within a week, along with same day availability of Smartrise Controllers and multiple types of door operators. SEES also stocks many different sizes of doors for same day shipping. Whatever your Elevator Modernization needs are, SEES can provide the fastest solutions possible.



FEATURES

- » Imperial Motor
- » 50HL/80 starts per hour; up to two motors per tank
- » SEIM Pump
- » Maxton or EECO Valve
- » Muffler standard for removing pulsation & noise
- » Oil level detection via dip stick or sight gauge
- » Isolation between pump, motor assembly and tank
- » Grooved or threaded fittings available



OPTIONAL FEATURES

- Low Pressure Switch • Oil Level Sight Gauge
- Viscosity Temperature Switch • Air Bladder Muffler
- Full Down Compensation • Oil Cooler • Thermostat
- Tank Heater • Pressure Gauge • Load Weighing Switch

COLOR OPTIONS & YOUR COMPANY LOGO AVAILABLE



The SEES submersible power unit has been designed to fit through machine room doorways as small as 25" wide.



Acoustiblok soundproofing option keeps your submersible tank operating on the **QT**



Today's Date: _____

Quote Due Date: _____



Quiet Tank Quote Request Form

Customer: _____ Job Name: _____
 Contact: _____ Location: _____
 Phone: _____ Cell: _____ Required Ship Date: _____
 Fax: _____ Shipping Address: _____
 E-mail: _____

Car Type:

- Single Jack (Direct) Twin Jack Roped
 Twin Jack (Direct) Telescopic
 Single Jack (Roped) In Ground

Tank Type:

- Dry Submersible

Available Options:

- Pressure Gauge Oil Cooler
 Valve Drain Load Weighing
 Low Oil Level Switch Vent Opening
 Oil Level Sight Gauge Tank Heater
 Under Tank Isolation Oil Return Pump
 Low Pressure Switch
 Oil Viscosity Switch
 Conduit Box with Terminal Block
 Enclosure Panels (Dry PU Only)
 Vent Filler Breather / Protected
 Overflow Connection Provisions
  Sound Absorber

Project Data:

- Down Speed Regulated:** Y N
Muffler: Bladder Chamber Dampener
Valve: Maxton EECO
Voltage: 3 Phase 200-208 3 Phase 220-240
 3 Phase 440-480 3 Phase 575-600

- Horsepower:** _____
Speed Up: _____ feet per minute
Speed Down: _____ feet per minute
Capacity: _____ lbs. Relief _____ psi
Car Weight: _____ lbs. No Load _____ psi
Gross Load: _____ lbs. Full Load _____ psi
 (Capacity + Car Weight)
Travel: _____ feet
Piston DIA: _____ inches
Hertz: 50 60 120
Starts per hour: 80 120
Pipe Size: 2 2.5 3
Tank Outlet: Grooved Threaded
Tank Hand: Right Left
Coil Voltage: 115 VAC 230 VAC 115 VDC

Contact SEES with confidence:
800-526-0026
www.seesinc.com
Fax to 954-917-7337
 Email for quote: info@seesinc.com

V2

ELEVATOR CONTROL SYSTEM



HYDRAULIC CONTROLLER

One of the only hydraulic controllers on the market with velocity and distance feedback along serial communications. Reduces valve adjustment time by showing the car's performance on the LCD display.

APPLICATION	<i>Supports overhead, basement, and machine room-less</i>
FEEDBACK	<i>Distance and velocity</i>
DISPATCH	<i>Up to 8 car group</i>
MAX. OPENINGS	10
MAX. SPEED	200FPM
DIMENSIONS	34"H x 24"W x 10"D
CABINET	NEMA 1, 4, 4x, and 7

Optional Accessories

- Local and Remote Monitoring
- SmartConnect Pre-wired Inspection Box
- Isolation Transformer
- Load-Weighing Device
- Emergency Rescue Device
- Voice Annunciator Interface
- Card Reader Access
- Traveler and Hoistway Cables
- OSHPD Certified
- Air Conditioning Unit



SEES Inc



SEESParts

Always Smooth Sailing

2781 West McNab Rd, Pompano Beach, FL 33069 • (800) 526-0026 • www.SEEInc.com



SMARTRISE

» SMARTRISE

Smartrise developed an innovative elevator controller system that gave customers an open-market choice in the elevator industry. Using their universal printed circuit boards in every single controller they ship, Smartrise provides a consistent, easy to install product no matter the project, from hydro to traction, geared or gearless.



SEES Universal Roller Guide

» Roller Guides

S.E.E.S. #	O.E.M. #	Description
URG-001	ED02000	3-1/4" Universal 3 wheel roller guide Model D
URG-002	EB02100	6" Universal 3 wheel roller guide Model B

» Replacement Rollers

S.E.E.S. #	O.E.M. #	Description
MIS-143S	EC18405	3-1/4" diameter, .4724 bore wheel
MIS-142	EA18359	6" diameter, .7874 bore wheel



MIS-143S



MIS-142



URG-001



URG-002

Hanger & Track Assemblies

S.E.E.S. #	O.E.M. #	Description
GDO-HDT-001	HH1-0017N	Hanger Track , Hatch Door 40-42 Single Speed 82" Lg with hardware
GDO-HDT-001A	HH19-0026N	Hanger Track , Hatch Door 40-42 Single Speed 82" Lg Zinc Plate
GDO-HDT-002	HH1-0016N	Hanger Track , Hatch Door 37-39 Single Speed 76" Lg with hardware
GDO-HDT-003	HHN-0018N	Hanger Track , Hatch Door 43-45 Single Speed 88" Lg with hardware
GDO-HDT-004	HH1-0015N	Hanger Track , Hatch Door 34-36 Single Speed 70" Lg with hardware

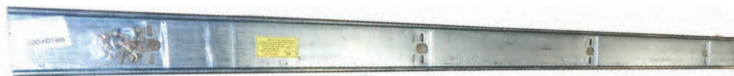

GDO-HDT-003



GDO-HDT-001

S.E.E.S. #	O.E.M. #	Description
GDO-11	HH1-0022R	Door Hanger Assembly , sheave assembly complete R.H. 4-1/8" CL with 3/8-16 Bolts
GDO-11-P		Door Hanger Assembly , Type A, R.H. with poly roller
GDO-11A	HH1-0022L	Door Hanger Assembly , sheave assembly complete L.H. 4-1/8" CL with 3/8-16 Bolts
GDO-11A-P		Door Hanger Assembly , Type A, L.H. with poly roller
GDO-11B	HH3-0034R	Door Hanger Assembly , Sheave assembly complete, R.H. with Top Safety Retainers
GDO-11C	HH3-0034L	Door Hanger Assembly , Sheave assembly complete, L.H. with Top Safety Retainers



GDO-11

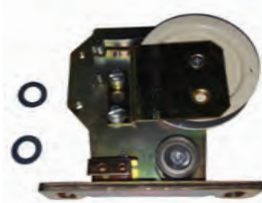

GDO-11-P



GDO-11A



GDO-11B



GDO-11C

» GAL Door Operators

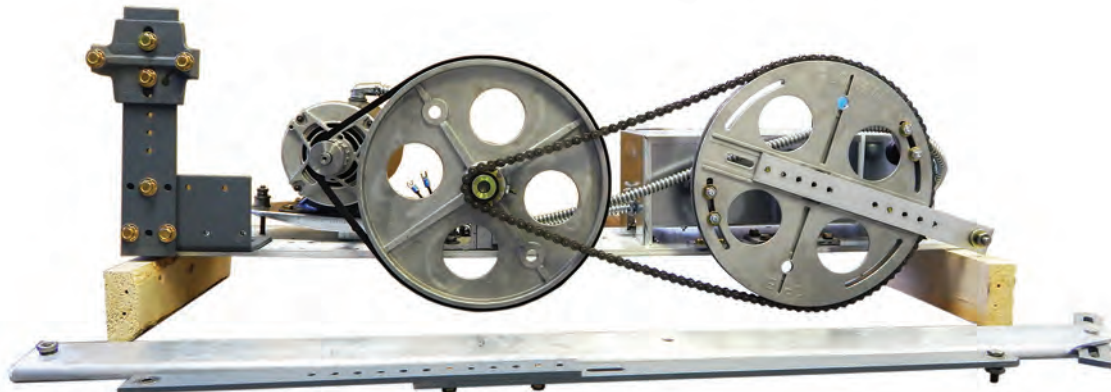

GDO-MOVFR-002R

S.E.E.S. #	O.E.M. #	Description
GDO-MOVFR-002L	OP99-0002L	Door Operator, L.H., MOVFR, Single Speed-2 Speed 25"-29", 208 VAC, 13" Hdr
GDO-MOVFR-002R	OP99-0002R	Door Operator, R.H., MOVFR, Single Speed-2 Speed 25"-29", 208 VAC, 13" Hdr
GDO-MOVFR-003L	OP99-0003L	Door Operator, L.H., MOVFR, Single Speed-2 Speed 30"-34", 208 VAC, 13" Hdr
GDO-MOVFR-003R	OP99-0003R	Door Operator, R.H., MOVFR, Single Speed-2 Speed 30"-34", 208 VAC, 13" Hdr
GDO-MOVFR-004L	OP99-0004L	Door Operator, L.H., MOVFR, Single Speed-2 Speed 35"-39", 208 VAC, 13" Hdr
GDO-MOVFR-004R	OP99-0004R	Door Operator, R.H., MOVFR, Single Speed-2 Speed 35"-39", 208 VAC, 13" Hdr
GDO-MOVFR-005L	OP99-0005L	Door Operator, L.H., MOVFR, Single Speed-2 Speed 40"-44", 208 VAC, 13" Hdr
GDO-MOVFR-005R	OP99-0005R	Door Operator, R.H., MOVFR, Single Speed-2 Speed 40"-44", 208 VAC, 13" Hdr
GDO-MOVFR-006L	OP99-0006L	Door Operator, L.H., MOVFR, Single Speed-2 Speed 45"-48", 208 VAC, 13" Hdr
GDO-MOVFR-006R	OP99-0006R	Door Operator, R.H., MOVFR, Single Speed-2 Speed 45"-48", 208 VAC, 13" Hdr
GDO-MOVFR-006L-A	OP99-0006L	Door Operator, L.H., MOVFR, SS-2Spd 45-48", 115 VAC, Drive V

S.E.E.S. #	O.E.M. #	Description
GDO-MOVFR-200	OP101-0028N	Door Operator, MOVFR II 2SCP Special, with Door Drive Arm
GPC-201	MOVFR-0072N	Drive, 115 VAC for MOVFR II Oper Includes Drive Ribbon Cable

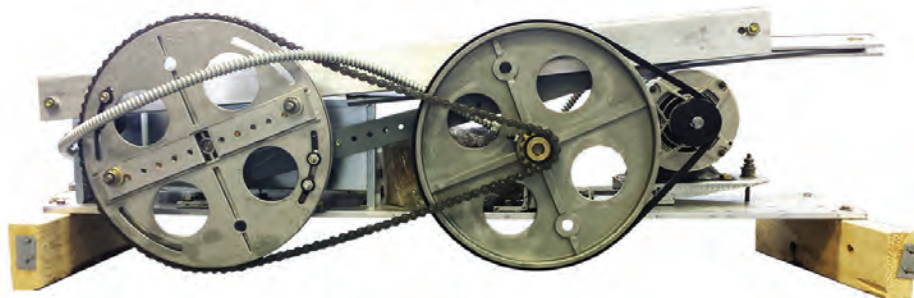

GDO-MOVFR-103

S.E.E.S. #	O.E.M. #	Description
GDO-MOVFR-101	OP100-0003N	Door Operator, CP, MOVFR, Single Speed-2 Speed, 30"-33" D.O., 208 VAC, 15" Hdr
GDO-MOVFR-102	OP100-0003N	Door Operator, CP, MOVFR, Single Speed-2 Speed, 34"-39" D.O., 208 VAC, 15" Hdr
GDO-MOVFR-103	OP100-0003N	Door Operator, CP, MOVFR, Single Speed-2 Speed, 40"-49" D.O., 208 VAC, 15" Hdr
GDO-MOVFR-104	OP100-0003N	Door Operator, CP, MOVFR, Single Speed-2 Speed, 50"-54" D.O., 208 VAC, 15" Hdr
GDO-MOVFR-105	OP100-0003N	Door Operator, CP, MOVFR, Single Speed-2 Speed, 55"-59" D.O., 208 VAC, 15" Hdr

» Doors

Cab Door Features

- Doors are available in single-speed side slide, center-opening, two-speed side slide configurations
- Various door widths and heights are available to accommodate your project's needs
- Doors finish is stainless steel brushed (#4 finish) on 20 gauge material
- Doors are rated for 90 minutes fire resistance and UL Labeled accordingly



SEES-CAB-36-84-SS-R



SEES-CAB-42-84-CP



SEES-CAB-36-84-2SP-R

Cab/Cab Doors

S.E.E.S. #	Hand	Speed	Opening	Height	Hanger Mounting Hole Dimensions	Material/Finish
SEES-CAB-48-84-2S-L-S	Left	Double	24"	84"	4.125" Slow Door Only	Stainless Veneer
SEES-CAB-34-84-SS-R	Right	Single	34"	84"	4.125"	Stainless Veneer
SEES-CAB-36-84-SS-R	Right	Single	36"	84"	4.125"	Stainless Veneer
SEES-CAB-36-84-SS-L	Left	Single	36"	84"	4.125"	Stainless Veneer
SEES-CAB-36-84-2SP-R	Right	Two	36"	84"	4.125"	Stainless Veneer
SEES-CAB-36-84-2SP-L	Left	Two	36"	84"	4.125"	Stainless Veneer
SEES-CAB-36-84-CP-5WL	Left	Single	36"	84"	4.125"	5WL Stainless Steel
SEES-CAB-36-84-SS-L-M	Left	Single	36"	84"	4.125"	Muntz Veneer
SEES-CAB-36-84-SS-L-OTI-INTGRL	Left	Single	36"	84"	4.125" w/ Otis Integral Hangers	Stainless Veneer
SEES-CAB-36-84-SS-R-OTI-INTGRL	Right	Single	36"	84"	4.125" w/ Otis Integral Hangers	Stainless Veneer
SEES-CAB-36-84-SS-L-OTIS	Left	Single	36"	84"	4.125"	Stainless Veneer
SEES-CAB-36-84-SS-L-SPECIAL	Left	Single	36"	84"	4.125"	Stainless Veneer
SEES-CAB-36-84-SS-R-SPECIAL	Right	Single	36"	84"	4.125"	Stainless Veneer
SEES-CAB-36-84-SS-R-WIN	Right	Single	36"	84"	4.125" w/ Window - SPECIAL	Stainless Veneer
SEES-CAB-40-84-2SP-L-BB	Left	Two	40"	84"	4.125"	#4 Brushed Brass
SEES-CAB-40-84-CP	Center	Single	40"	84"	4.125"	Stainless Veneer
SEES-CAB-42-84-CP-5WL	Right	Single	40"	84"	4.125" w/ Window - SPECIAL	Stainless Veneer
SEES-CAB-42-84-CP	Center	Single	42"	84"	4.125"	Stainless Veneer
SEES-CAB-42-84-SS-R	Right	Single	42"	84"	4.125"	Stainless Veneer
SEES-CAB-42-84-SS-L	Left	Single	42"	84"	4.125"	Stainless Veneer
SEES-CAB-42-88.75-SS-L	Left	Single	42"	88.75"		Stainless Veneer
SEES-CAB-42-84-2SP-L	Left	Two	42"	84"	4.125"	Stainless Veneer
SEES-CAB-43.5-84.25-SS-R	Right	Single	42"	84.25"	Not Drilled	Stainless
SEES-CAB-43.5-84.25-SS-L	Right	Single	42"	84.25"	Not Drilled	Stainless
SEES-CAB-44-84-2SP-L	Left	Two	44"	84"	4.125"	Stainless Veneer
SEES-CAB-42-84-2SP-R	Right	Two	42"	84"	4.125"	Stainless Veneer
SEES-CAB-42-84-2SP-L	Left	Two	42"	84"	4.125"	Stainless Veneer
SEES-CAB-46-84-2SP-L	Left	Two	42"	84"	4.125"	Stainless Veneer
SEES-CAB-46-84-2SP-R	Right	Two	42"	84"	4.125"	Stainless Veneer

Cab / Cab Doors



SEES-CAB-34-84-SS-R



SEES-CAB-54-84-2S-CP



SEES-CAB-54-84-2S-RH

MOD PACKAGES

S.E.E.S. #	Hand	Speed	Opening	Height	Hanger Mounting Hole Dimensions	Material/Finish
SEES-CAB-42-84-CP-6940	Center	Single	42"	84"	4.125" GAL Hangers and Otis 6940 Locks	Stainless Veneer
SEES-CAB-42-84-CP-CA-M	Center	Single	42"	84"	4.125"	Stainless Veneer
SEES-CAB-42-84-CP-M	Center	Single	42"	84"	4.125"	Stainless Veneer
SEES-CAB-42-84-CP-MAC	Center	Single	42"	84"	4.125"	Stainless Veneer
SEES-CAB-42-84-CP-OTIS-6940	Center	Single	42"	84"	4.125"	Stainless Veneer
SEES-CAB-42-84-SS-L-OTIS	Left	Single	42"	84"	4.125"	Stainless Veneer
SEES-CAB-42-89.5-SS-R	Right	Single	42"	84"	4.125"	Stainless Veneer
SEES-CAB-43.5-83.25-SS-L-BLANK	Left	Single	43.5"	83.25"	Not Drilled	Stainless
SEES-CAB-44-84-SS-CP	Center	Single	44"	84"	4.125"	Stainless Veneer
SEES-CAB-44-84-SS-CP-A	Center	Single	44"	84"	4.125" Top Hole Only	Stainless Veneer
SEES-CAB-46-84-2S-CP	Center	Double	46"	84"	4.125"	Stainless Veneer
SEES-CAB-48-84-CP-SCH	Left		48"	84"	Drilled for Schindler	Stainless Veneer
SEES-CAB-48-84-2S-L	Left	Two	48"	84"	4.125"	Stainless Veneer
SEES-CAB-48-103-SS-CP-M	Center	Single	48"	103"	4.125"	Mirrored Stainless Steel
SEES-CAB-48-84-2S-R	Right	Two	48"	84"	4.125"	Stainless Veneer
SEES-CAB-48-84-2S-R-SPO-BLANK	Right	Two	48"	84"	Not Drilled, with Spec.	Dims
SEES-CAB-48-84-2S-L-BLANK	Left	Two	48"	84"	No Holes	Stainless Veneer
SEES-CAB-48-84-2S-CP	Center	Two	48"	84"	4.125"	Stainless Veneer
SEES-CAB-48-84-2S-R-6940	Right	Double	48"	84"	4.125" GAL Hangers and 6940 Lock	Stainless Veneer
SEES-CAB-48-84-2S-R-OTIS-6940	Right	Double	48"	84"	4.125" with Otis 6940 Lock	Stainless Veneer
SEES-CAB-48-84-SS-CP	Center	Single	48"	84"	4.125"	Stainless Veneer
SEES-CAB-48-96-2S-L	Left	Double	48"	96"	4.125"	Stainless Veneer
SEES-CAB-52-84-2S-LH	Left	Double	52"	84"	4.125"	Stainless Veneer
SEES-CAB-52-84-2S-RH	Right	Double	52"	84"	4.125"	Stainless Veneer
SEES-CAB-54-84-2S-CP	Center	Double	54"	84"	4.125"	Stainless Veneer
SEES-CAB-54-84-2S-LH	Left	Double	54"	84"	4.125"	Stainless Veneer
SEES-CAB-54-84-2S-RH	Right	Double	54"	84"	4.125"	Stainless Veneer
SEES-CAB-54-90-SS-CP	Center	Single	54"	90"	4.125"	Stainless Veneer
SEES-CAB-54-84-2S-RH	Right	Two	54"	84"	4.125"	Stainless Veneer
SEES-CAB-54-84-2S-CP	Center	Two	54"	84"	4.125"	Stainless Veneer
SEES-CAB-54-84-2S-LH	Left	Two	54"	84"	4.125"	Stainless Veneer
SEES-CAB-CP-SPECIAL	Center	Per Spec				

Door Features

- Doors are available in single-speed side slide, center-opening, two-speed side slide configurations
- Various door widths and heights are available to accommodate your project's needs
- Doors finish is stainless steel brushed (#4 finish) on 20 gauge material
- Doors are rated for 90 minutes fire resistance and UL Labeled accordingly

Hall / Entrance

S.E.E.S. #	Hand	Speed	Opening	Height	Hanger Mounting Hole Dimensions	Material/Finish
SEES-ENT-36-84-SS-R-OTI-INTGRL	Right	Single	36"	84"	4.125", w/ Otis Integral Hangers	Stainless Veneer
SEES-ENT-36-84-SS-L-OTI-INTGRL	Left	Single	36"	84"	4.125", w/ Otis Integral Hangers	Stainless Veneer
SEES-ENT-36-84-SS-L	Left	Single	36"	84"	4.125"	Stainless Veneer
SEES-ENT-36-84-SS-R	Right	Single	36"	84"	4.125"	Stainless Veneer
SEES-ENT-36-84-SS-L-CA	Left	Single	36"	84"	4.125" H w/o Escutcheon Holes	Stainless Veneer
SEES-ENT-36-84-SS-R-CA	Right	Single	36"	84"	4.125" H w/o Escutcheon Holes	Stainless Veneer
SEES-ENT-36-84-2SP-L	Left	Two	36"	84"	4.125"	Stainless Veneer
SEES-ENT-36-84-2SP-R	Right	Two	36"	84"	4.125"	Stainless Veneer
SEES-HALL-40-84-2SP-L-BB	Left	Two	40"	84"	4.125"	#4 Brushed Brass
SEES-ENT-40.25-84-2SP-R	Right	Two	40.25"	84"	4.125"	Stainless Veneer
SEES-ENT-42-84-SS-L	Left	Single	42"	84"	4.125"	Stainless Veneer
SEES-ENT-42-84-SS-L-DVR	Left	Single	42"	84"	4.125"	#4 Stainless Steel
SEES-ENT-42-84-SS-R	Right	Single	42"	84"	4.125"	Stainless Veneer
SEES-ENT-42-84-SS-R-BLANK	Right	Single	42"	84"	No holes	Stainless Veneer
SEES-ENT-42-84-CP	Center	Single	42"	84"	4.125"	Stainless Veneer
SEES-ENT-42-84-2SP-L	Left	Two	42"	84"	4.125"	Stainless Veneer
SEES-ENT-42-84-2SP-L-BLANK	Left	Two	42"	84"	No Holes	Stainless Veneer
SEES-ENT-42-84-2SP-R	Right	Two	42"	84"	4.125"	Stainless Veneer
SEES-ENT-42-107-CP	Center	Single	42"	107"	4.125", GAL, Left oriented	Stainless Veneer
SEES-ENT-42-84-CP-CA	Center	Single	42"	84"	4.125" H w/o Escutcheon Holes	Stainless Veneer
SEES-ENT-46-84-2SP-L	Left	Two	46"	84"	4.125"	Stainless Veneer
SEES-ENT-46-84-2SP-R	Right	Two	46"	84"	4.125"	Stainless Veneer
SEES-ENT-48-84-2SP-L	Left	Two	48"	84"	4.125"	Stainless Veneer
SEES-ENT-48-84-2SP-L-CA	Left	Single	48"	84"	4.125" H w/o Escutcheon Holes	Stainless Veneer
SEES-ENT-48-84-2SP-RH-MAYO-OTI	Right	Two	48"	84"	Drilled for Otis	Stainless Steel
SEES-ENT-48-84-2SP-R-CA	Right	Single	48"	84"	4.125" H w/o Escutcheon Holes	Stainless Veneer
SEES-ENT-48-84-SS-CP-DVR-INTGR	Center	Single	48"	84"	Dover Intgrl Hangers	Stainless Veneer
SEES-ENT-OTIS-84-SS-RH	Right	Single	46-3/8"	84-1/2"	4.125"	Stainless Veneer
SEES-ENT-54-84-2S-RH	Right	Two	54"	84"	4.125"	Stainless Veneer
SEES-ENT-54-84-2S-CP	Center	Two	54"	84"	4.125"	Stainless Veneer
SEES-ENT-54-84-2S-LH	Left	Two	54"	84"	4.125"	Stainless Veneer
SEES-JAMB-48-96-2SP-RH	Right	Two	48"	96"	No Holes	Stainless Veneer

Doors For California Only

S.E.E.S. #	Hand	Speed	Opening	Height	Hanger Mounting Hole Dimensions	Material/Finish
SEES-ENT-42-84-2SP-R-CA	Right	Two	42"	84"	W/o Escutcheon Holes	Stainless Veneer
SEES-ENT-42-84-SS-R-CA	Right	Single	42"	84"	W/o Escutcheon Holes	Stainless Veneer
SEES-ENT-42-84-SS-L-CA	Left	Single	42"	84"	W/o Escutcheon Holes	Stainless Veneer
SEES-ENT-43.5-83.25-SS-L-CA-BL	Left	Single	43.5"	83.25"	Not Drilled, w/o Escutcheon Holes	Stainless Steel
SEES-ENT-43.5-83.25-SS-R-CA-BL	Right	Single	43.5"	83.25"	Not Drilled, w/o Escutcheon Holes	Stainless Steel
SEES-ENT-48-84-2SP-L-CA-BLANK	Left	Two	48"	84"	No Holes, w/o Escutcheon Holes	Stainless Veneer

Sight Guards

S.E.E.S. #	Description
SEES-ENT-52-84-2S-RH	Sight Guards, for SEES-ENT-48-84-2SP-L
SEES-ENT-SG-84-001	Sight Guards, for SEES-ENT-SG-84-001
SEES-ENT-SG-84-001	Sight Guards, Special Size

Hall / Entrance

S.E.E.S. #	Hand	Speed	Opening	Height	Hanger Mounting Hole Dimensions	Material/Finish
SEES-ENT-36-84-2SP-L-BLACK	Left	Double	36"	84"	4.125"	Painted black
SEES-ENT-36-84-2SP-R-BLACK	Right	Double	36"	84"	4.125"	Painted black
SEES-ENT-36-84-CP	Center	Single	36"	84"	4.125"	Stainless Veneer
SEES-ENT-36-84-SS-L-THY	Left	Single	36"	84"	4.125"	Stainless Veneer
SEES-ENT-36-84-SS-L-TKE	Left	Single	36"	84"	4.125" Drilled for TKE	Stainless Veneer
SEES-ENT-36-84-SS-L-WHITE	Left	Single	36"	84"	4.125"	Painted White
SEES-ENT-42-84-CP-6940	Center	Single	42"	84"	4.125" GAL Hangers and Otis 6940 Locks	Stainless Veneer
SEES-ENT-42-84-CP-CA-M	Center	Single	42"	84"	4.125" w/o Escutcheon Hole	Stainless Veneer
SEES-ENT-42-84-SS-L-316	Left	Single	42"	84"	4.125" Galv. Core	#4 Brushed Brass
SEES-ENT-42-84-CP-OTIS-6940	Center	Single	42"	84"	4.125" Otis 6940 Locks and Hangers	Stainless Veneer
SEES-ENT-42-84-SS-L-P4P	Left	Single	42"	84"	4.125"	Primed for Paint
SEES-ENT-42-84-SS-L-THY	Left	Single	42"	84"	4.125" Drilled for TKE	Primed for Paint
SEES-ENT-42-84-SS-L-TKE	Left	Single	42"	84"	4.125" Drilled for TKE	Stainless Veneer
SEES-ENT-42-84-CP-CA-M	Left	Single	42"	84"	4.125" Drilled for TKE	Stainless Veneer
SEES-ENT-42-84-SS-R-316	Right	Single	42"	84"	4.125"	Stainless Veneer
SEES-ENT-42-84-SS-R-P4P	Right	Single	42"	84"	4.125"	Primed for Paint
SEES-ENT-46-84-2S-CP-P4P	Center	Double	46"	84"	4.125"	Primed for Paint
SEES-ENT-46-84-2S-L-P4P	Left	Double	46"	84"	4.125"	Primed for Paint
SEES-ENT-46-84-2S-R-P4P	Right	Double	46"	84"	4.125"	Primed for Paint
SEES-ENT-48-84-2S-CP	Center	Double	48"	84"	4.125"	Stainless Veneer
SEES-ENT-48-84-2S-CP-CA	Center	Double	48"	84"	4.125" w/o Escutcheon Holes	Stainless Veneer
SEES-ENT-48-84-2SP-L-PACKAGE	Left	Double	48"	84"	4.125" Per Specs and Drawing	Stainless Veneer
SEES-ENT-48-84-2SP-L-THY	Left	Double	48"	84"	4.125" Thyssen Drilling	Stainless Veneer
SEES-ENT-48-84-2SP-R-THY	Right	Double	48"	84"	4.125" Thyssen Drilling	Stainless Veneer
SEES-ENT-48-84-2S-R	Right	Double	48"	84"	4.125"	Stainless Veneer
SEES-ENT-48-84-2S-R-6940	Right	Double	48"	84"	4.125" GAL Hangers and Otis 6940 Locks	Stainless Veneer
SEES-ENT-48-84-2S-R-OTIS-6940	Right	Double	48"	84"	4.125" Otis 6940 Lock	Stainless Veneer
SEES-ENT-48-96-2S-L	Left	Double	48"	96"	4.125"	Stainless Veneer
SEES-ENT-52-84-2S-LH	Left	Double	52"	84"	4.125"	Stainless Veneer
SEES-ENT-52-84-2S-RH	Right	Double	52"	84"	4.125"	Stainless Veneer

The ENFORCER[®]

Door Gibs. Redefined.

SAFETY FIRST... BUILT TO LAST

PATENT # SEES 8,181,394

CAN HANDLE OVER 18,000 lb OF FORCE!



SEES-ENFORCER-001

7/16"

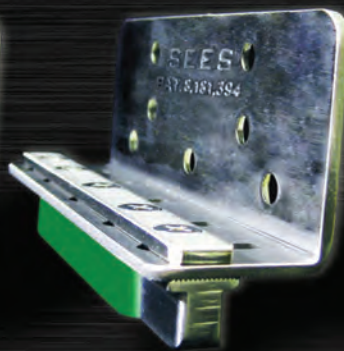

SEES-ENFORCER-002

15/32"

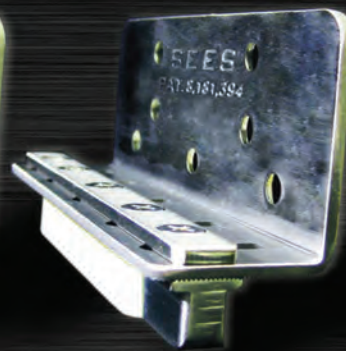

SEES-ENFORCER-003

1/2"

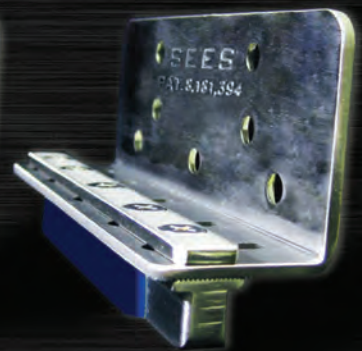

SEES-ENFORCER-004

17/32"

IDEAL FOR: AIRPORTS, HOSPITALS, CONDOS, COLLEGES & UNIVERSITIES, HOTELS, TRANSIT AUTHORITIES, PRISONS & JAILS, STORAGE FACILITIES, APARTMENTS AND ANY PUBLIC HOUSING.

SAFETY: Limits liability due to door failure | **DURABILITY:** Less call backs, reduce door damage | **SAVINGS:** Reduce service calls with fewer gib replacement/door alignment.



@SEESinc



SEESinc.com/blogs

Always Smooth Sailing



SOUTHERN ELEVATOR
& ELECTRIC SUPPLY

KNOW ENFORCER^{EDGE} KNOW SAFETY

PATENT # SEES 8,181,394

Enforcer^{EDGE}

REPLACES ALL OF THESE GIB KITS

Part Number	Gib width
SEES-ENFORCER-EDGE-R	7/16"
SEES-ENFORCER-EDGE-G	15/32"
SEES-ENFORCER-EDGE-W	1/2"
SEES-ENFORCER-EDGE-B	17/32"

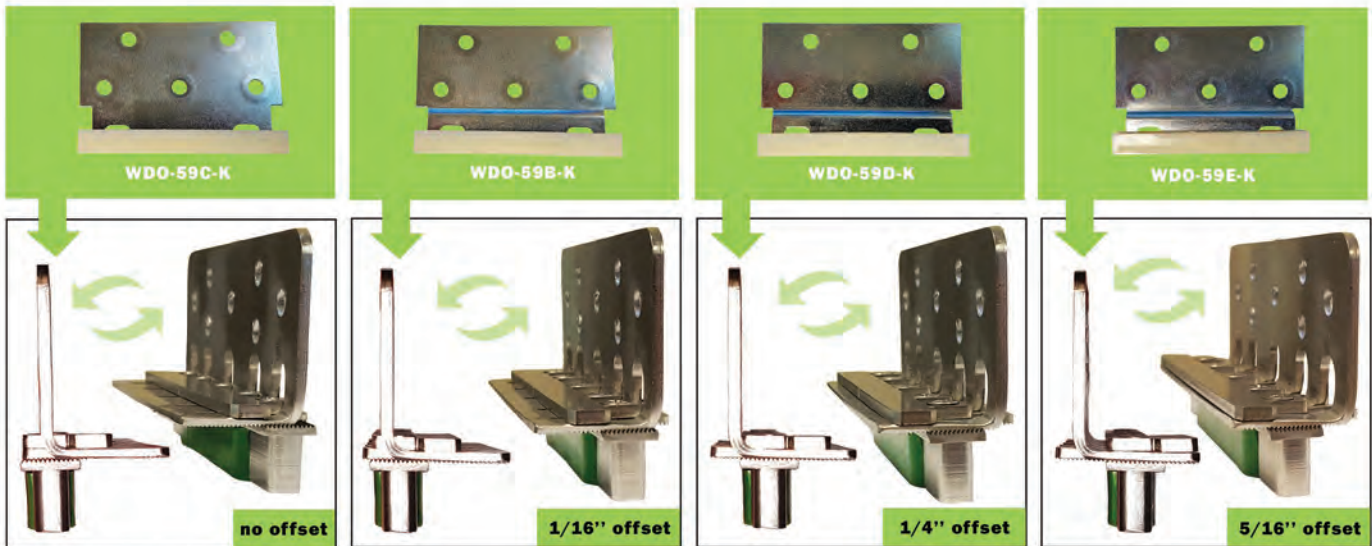
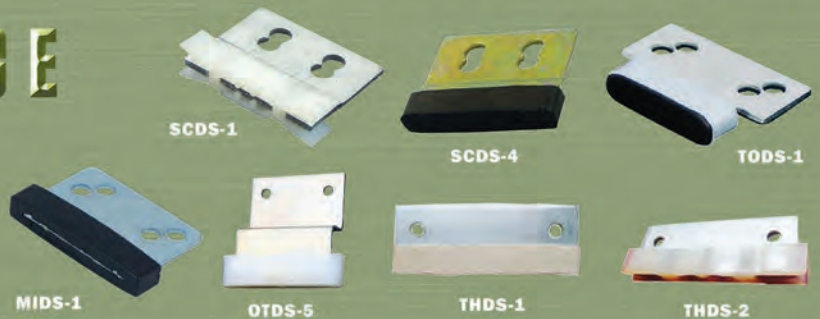

NO OFFSET? NO PROBLEM: SEES Enforcer Edge is perfect for Westinghouse elevators with offsets between 0 and 5/16ths.



Always Smooth Sailing



2781 West McNab Rd., Pompano Beach, FL 33069 • 800-526-0026 • www.SEEInc.com

SOUTHERN ELEVATOR & ELECTRIC SUPPLY



**SOUTHERN ELEVATOR
& ELECTRIC SUPPLY**



VANDAL RESISTANT PUSHBUTTONS
See page 333



See page 232



See page 328



See page 261

1.800.526.0026

Tel 954.971.1115 Fax 954.917.7337

www.SEESinc.com

**Distribution Center
1150 W. McNab Rd.**

Fort Lauderdale, FL 33309

**Global Headquarters
2781 W. McNab Rd.**

Pompano Beach, FL 33069

Serving Elevator Professionals Since 1977.



See page 368

YOUR SEES ACCOUNT # _____
SEND ORDERS TO: orders@seesinc.com



SEES GUARDIAN

ELEVATOR DOORS

See page 243



DOORS IN STOCK!

sprecher+
schuh
See page 296

THE SEES
H₂O
Alarm
See page 428

*Life*LINE 
See page 328

The
Enforcer
Door Gibs. Redefined.
See page 232



See page 238



SEES
SMOOTHGUIDE
ROLLER GUIDES
See page 494

BARRACADATM
See page 449



Welcome

We are pleased to present the latest edition of SEES Elevator and Escalator Catalog.

The SEES catalog is bigger and better than ever with the addition of many new parts and products. Many brought about by requests and suggestions from our valued customers, the elevator professional. Thank you for your input.

Please take a moment to review each section to become familiar with our products for future reference. Please note the fully expanded Escalator section as well as the Printed Circuit Board sections of each OEM.

The SEES catalog design ensures that your material sourcing is FAST and EASY. Replacement parts are organized by original equipment manufacturer (OEM) and then grouped by product category. Color photos, descriptions with specifications, and part numbers aid in part identification. The index and OEM cross reference provide a quick page locator.

The SEES website, www.SEESinc.com, home of the SEES Cyberstore, is always open and ready for business. This user friendly site offers real time availability and pricing for fast and easy shopping. Place orders online with confidence and ease.

As the elevator market develops and grows internationally, SEES will continue to bring new parts and innovative products to our customers worldwide.

Thank you for your business and the opportunity to be of service. We look forward to hearing from you.



"Our Mission is to become the BEST elevator parts company in the world by dedicating our resources, our talents and our energies, to help improve the elevator industry."





MANUFACTURING DEPARTMENT

SEES, an ISO 9001 Certified Manufacturer, utilizes lean manufacturing techniques and advanced technology to produce quality products. **MADE IN THE U.S.A.** SEES state of the art machining capabilities produce high volume parts at low costs as well as the ability for quick turn around times on custom or short run manufacturing. Contact SEES with confidence.

Always Smooth



Sailing...



DISTRIBUTION CENTER

Same day shipping, extended hours, plus the industry's largest, most diverse inventory ensures reliable delivery of your required parts and supplies. Contact SEES with confidence- the fast and easy solution for all of your elevator and escalator needs.





MODERNIZATION CENTER

SEES continues to reinvest in new facilities, machinery, and technology to bring to YOU, our valued customers, state of the art new products and services. The New SEES Modernization Plant is where Hydraulic Power Units, Home Elevator Packages, Doors, sheet metal fabrication, and plastic injection parts are manufactured.



ORDER ONLINE
www.SEESinc.com



HOW TO ORDER

By Phone:

800.526.0026

954.971.1115

By Fax:

954.917.7337



By Mail:

2781 W. McNab Rd.
Pompano Beach, FL 33069

1150 W. McNab Rd.
Fort Lauderdale, FL 33309

SHIPPING

Call SEES with confidence
Orders shipped same day
8:00 a.m. to 7:00 p.m. EST.

SEES TABLE OF CONTENTS



MOD PACKAGES	1-21
ESCALATOR	43-116
CONSTRUCTION / MODERNIZATION	117-216
CONTROLLERS / MACHINE ROOM	217-228
DOORS / DOOR PARTS	229-262
ELECTRICAL COMPONENTS	263-310
FIXTURE / CAB AND PIT PRODUCTS	311-360
HOME / RESIDENTIAL LIFTS	361-374
HYDRAULIC EQUIPMENT	375-400
LIGHTING	401-424
PIT / CAR TOP AND RAILS	425-442
SAFETY	443-452
SIGNS AND BRAILLE	453-462
TOOLS / LUBRICANTS	463-490
WHEELS / ROLLERS AND GUIDES	491-510

OEM DIRECTORY	ESCALATOR PARTS	ELEVATOR PARTS
ARMOR		511-538
DOVER		539-602
ESCO		603-606
FUJITEC	49-52	607-610
GAL		611-648
HAUGHTON		649-668
HITACHI	54-56	669-672
HYUNDAI	56-59	
KONE / MONTGOMERY	66-78	673-708
MITSUBISHI	59-62	709-714
OTIS	78-91	715-784
PAYNE / O. THOMPSON		785-792
SCHINDLER / WESTINGHOUSE	96-114	793-862
THYSSENKRUPP	94-95	863-874
TOSHIBA	62-66	875-878
US		879-894
OEM PART NUMBER CROSS REFERENCE		895-944
SEES PART NUMBER INDEX		945-987

“To Our Valued Customers”

We are excited to introduce our newest catalog. This is our largest catalog to date in which we have added hundreds of new products.

The following are just a few highlights of the many benefits S.E.E.S., Inc. and this catalog has to offer:

- ✓ Industry’s largest variety of replacement parts and supplies
- ✓ Friendly, knowledgeable sales staff
- ✓ Easy to locate color coded O.E.M. sections
- ✓ Se habla Español
- ✓ O.E.M. cross reference and general index
- ✓ Quantity and blanket pricing
- ✓ Orders shipped same day 8:00 a.m. to 7:00 p.m. EST.
- ✓ Special orders welcomed
- ✓ Order online at www.SEEInc.com
- ✓ State-of-the-art Manufacturing and Production facility for all your custom work

We look forward to the opportunity to serve you!

NEW

Multi-Key	250, 252
World’s Best Screwdriver	467, 485
Fused Jumper	465-466
The Enforcer	232-233, 824
Alpha Tags	483-484
Smartork	249, 258-259

NEW PRODUCTS



** see page 250 for more information*



** see page 483 for more information*



REGISTRATION CERTIFICATE

This document certifies that the administration systems of

SEES, Inc.

Southern Elevator & Electric Supply

2781 West McNab Road, Pompano Beach, Florida 33069, USA

have been assessed and approved by QAS International to the following management systems, standards and guidelines:

ISO 9001:2015

The approved administration systems apply to the following:

SEES, Inc. is located in Pompano Beach, Florida and is engaged in the Design and Manufacture of Elevator and Escalator Parts and Assemblies.

Original Approval	21st April 2005
Current Certificate	21st April 2021
Certificate Expiry	21st April 2022
Certificate Number	US2496

Signed: Certification Officer

On behalf of QAS International

This certificate remains valid while the holder maintains their administration systems in accordance with the standards and guidelines stated above, which will be audited annually by QAS International. The holder is entitled to display the above registration mark for the duration of this certificate, which should be returned to QAS International upon reasonable request.
Issuing Office: QAS International, 5 Technology Park, Colindeep Lane, London, NW9 6BX, UK





THIS CERTIFIES THAT

S.E.E.S., Inc.

dba Southern Elevator & Electric Supply

* Nationally certified by the: **FLORIDA STATE MINORITY SUPPLIER DEVELOPMENT COUNCIL**

* NAICS Code(s) : 333921; 423610

* Description of their product/services as defined by the North American Industry Classification System (NAICS)

12/01/2021

FL02031

Issued Date

Certificate Number

Ying McGuire
NMSDC CEO and President

Beatrice Louissaint, President & CEO

12/01/2022

Expiration Date

By using your password (NMSDC issued only), authorized users may log into NMSDC Central to view the entire profile: <http://nmsdc.org>

Certify, Develop, Connect, Advocate.

* MBES certified by an Affiliate of the National Minority Supplier Development Council, Inc.®



GENERAL POLICIES

TO OPEN A SEES ACCOUNT please complete the Confidential Credit Application provided in the back of this catalog. Please contact SEES Customer Service for additional information. If purchases are tax-exempt, please provide a sales tax certificate.

PAYMENT TERMS are Net 30. Payment is due on receipt and payable prior to thirty days from invoice date. Past due invoices are subject to late payment service charges of 1-1/2% per month, 18% APR. All collection costs and legal fees resulting from non-payment are the responsibility of the customer.

CREDIT CARDS are accepted for payment, Visa, MasterCard or American Express

DELIVERY is provided per your requirements. Freight is F.O.B. shipping point. SEES standard carriers are UPS and FedEx, shipped pre-paid and billed unless other arrangements have been made. Get online tracking detail for all of your UPS shipments by visiting our website at www.SEEInc.com

CLAIMS & RETURNS Damage Claims must be made within 48 hours of receipt. Do not discard anything, all damaged goods, packing materials and shipping cartons must be kept for inspection and are required for insurance purposes. General returns (not damage claims) must be received within thirty (30) days of invoice date. The Return Authorization Form, located on the lower portion of the original Packing Slip, must be completed and returned with the shipment. Credit on account will be issued upon satisfactory receipt, inspection and approval of merchandise. All returns are subject to a minimum 15% restocking fee (\$30 minimum), additional testing charges will be applied as required. Returned merchandise must be shipped prepaid and insured. Any loss or damage is the responsibility of the shipper.

SPECIAL ORDERS require customer authorization for processing and are non-cancelable and non-returnable.

TITLE to any and all goods or materials hereafter

Printed in USA, Copyright © 2022. All Rights Reserved.

This catalog or parts there of may not be reproduced in any form without the written permission of SEES, Inc.
US \$33.95

purchased shall remain with SEES until the purchase price has been paid in full.

WARRANTY All sales are final, subject to existing warranty provisions. The manufacturer's guarantees of the products we distribute are passed to the customer. We expressly limit our liability to any guarantees extended by the manufacturer and are not responsible for any consequential or indirect damages resulting from the application and use of these products. All SEES manufactured products are warranted free from defects in material and workmanship for a period of 12 months from invoice date. SEES liability is limited to furnishing on an exchange basis, FOB shipping point, replacement for part(s) which have been promptly reported by the purchaser and inspected and confirmed by SEES to be defective. In no event whatsoever shall SEES, Inc. be liable for indirect, consequential, incidental, or special damages, including but not limited to, personal injury or property damage. The sole and exclusive remedy, and the limit of SEES liability for any type of loss shall NOT exceed the price paid by the purchaser for the product to which the claim is made. SEES shall not be responsible for any loss damage, labor charges, damage incurred during installation, damage incurred to other related parts, injuries, loss of income, incidental and consequential damages, or any loss whatsoever connected therewith. Our catalog is intended as a reference only, no claim is made as to the information herein, while every effort has been made, we cannot guarantee its accuracy. OEM part numbers are used for identification purposes only.



1-800-526-0026

954-971-1115

fax 954-917-7337

www.SEEInc.com





Quality Policy

Quality makes SEES an exceptional supplier of elevator and escalator products. For over 40 years, SEES has achieved world class quality through operational excellence, continual improvement, and a focus on customer satisfaction that has driven the company to being a global leader. Each employee plays a significant role in maintaining the quality customers have come to expect. From sales to engineering, and from production to shipping, results shall be monitored against set objectives and continuous improvement methodologies to enhance productivity, cost effectiveness, and customer satisfaction. SEES will be relentless in helping our customers achieve their goals by delivering superior products and service in a responsible and timely manner. SEES will never stop its pursuit of excellence.

SEES FIXTURES

SEES
SOUTHERN ELEVATOR
& ELECTRIC SUPPLY

*Add class & durability
to your elevator with
SEES fixtures*



*2-3 Week Lead Time on
Most Fixture Orders
& Competitive Pricing*



*Retrofit Packages and
Custom Sizes Available*



*Variety of Premium
Quality Components*

WHY CHOOSE US?

Over the last 45 years SEES has strived to offer the best solutions to all industry demands. We are now extending our innovation and superior quality trademark to the world of elevator fixtures.



SEES Inc



SEESParts



SEES, Inc.

Always Smooth Sailing

2781 West McNab Rd, Pompano Beach, FL 33069 • (800) 526-0026 • www.SEEInc.com



SEES FUSED JUMPER

SEES-JUMPER-001F

SAVES MONEY
SAVES LIVES

Human error is inevitable and even the best of us can make a mistake once in a while. Poorly lit machine rooms, hard to reach electrical components and electrical wiring diagram errors are just a few of the contributors to these mistakes.

The **SEES fused jumper** minimizes the potential damage to technicians and elevator components.

**Replaceable fuse up to 5 amps,
1/4" glass fuse** ⇓

ADVANTAGES

- » Adds an extra layer of electrical isolation/protection
- » Prevents electric shock to mechanic
- » Prevents damage to components
- » Happy technicians

STANDARD JUMPER KIT DISADVANTAGES

- » Injured technicians
- » Costly board replacement
- » Increased insurance costs
- » Angry customers
- » Downtime

» INCLUDES



Jumper Wire,
Alligator Clips



Jumper Wire,
Plunger Type



SEES Jumper,
Yellow Adaptor Pin



Velcro Pouch,
SEES Jumper Kit



SEES,
Wrist Band



Safety Labels,
Self Adhesive



SEES Inc



SEESParts

Always Smooth Sailing

2781 West McNab Rd, Pompano Beach, FL 33069 • (800) 526-0026 • www.SEEInc.com

Introducing...
**THE WORLD'S BEST ELEVATOR
SCREWDRIVER**

**\$15
FOR 1**

**\$12
FOR 10
OR MORE**

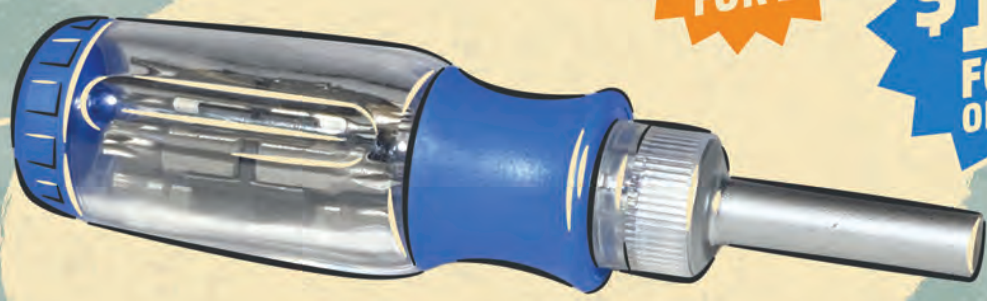

MIS-126A
*Screwdriver with
Ratchet & 12 Bits*

*Don't miss this
incredible **DEAL!!!***



Phillips #0, #1, #2

Slotted #4

Spanner #6 x #8, #10 x #12

Torx(R) T10 x T15, T20 x T25



Always Smooth Sailing

2781 West McNab Rd, Pompano Beach, FL 33069 • (800) 526-0026 • www.SEESinc.com



S.H.E. ISA 10

- 1. Machine RoomLess Elevator
- 2. Smooth ride counter-weighted traction equipment
- 3. No hydraulic oil
- 4. VVVF Drive
- 5. Standard LED lighting
- 6. Car Operating Panel with Emergency Light and Phone
- 7. Real Wood cab
- 8. 950 lb. capacity
- 9. 40 feet per minute
- 10. Made in the USA

CALL US : 800-526-0026



CUSTOMIZE

Choose from a wide range of features and options including wood types, handrails, light fixtures and cab styles. SEES will work with you to bring your vision to life.



MACHINE ROOM-LESS

No hydraulic cylinder, machine room or hydraulic oil. Instead, S.H.E. uses a small electric motor which fits within the hoistway overhead.



ENERGY SAVINGS

Thanks to the efficient motor and traction equipment, S.H.E. energy savings are estimated at 70-80% compared to hydraulic elevators.

WHY A SEES HOME ELEVATOR?

All SEES Home Elevators come with the SEEScreen Electronic Door Detector, designed to ensure maximum passenger safety. The SEEScreen's 94 infrared beams act as an invisible safety curtain across the door entrance. When an obstacle breaks the screen, the sensors detect it and immediately stop the elevator to avoid any accidents.



CONVENIENCE

S.H.E. improves in-home mobility and gives you the freedom to safely access any floor with ease.



INVESTMENT

S.H.E. is a sound investment and will increase your home's value and expand its marketability.



FLEXIBILITY

Purchase the S.H.E. with or without the cab. SEES will work with you to design and build exactly what you want.



MADE IN THE U.S.A.

S.H.E. is constructed from the finest materials at the SEES Modernization Center in Fort Lauderdale.

CONTACT US

By Phone:
800.526.0026
954.971.1115

By Fax:
954.917.7337
Visit Us: www.SEEInc.com



LOSING MONEY ON CALL BACKS?

Introducing...

SMARTORK

Elevator Hoistway
Door Closer



What does it do?

As the door closes, the innovative SMARTORK overcomes wind resistance by design. The SMARTORK, with its helical groove design, actually regains tension as it closes the door. SMARTORK provides more tension in the "door-close" cycle than it does in the "door-open" cycle. It's easy to install; just remove the "Old Style" unit and install the SMARTORK as a replacement. Call today and ask for SEES part number:

MIS-124-ST

Don't forget your brackets:

MIS-124-ST-BK

Contact Us!

800.526.0026

SMARTORK™



- 800.526.0026
- info@seesinc.com
- www.facebook.com/SEESinc

Visit Our Website:
www.seesinc.com

- ▶ The "Uni-hub" allows for easy installation
- ▶ SMARTORK saves money on non-chargeable and non-billable hours for elevator companies dealing with "Wind Resistance Issues"
- ▶ Reliable solution to nuisance call-backs
- ▶ Maintenance calls to add or remove "wraps" will virtually be a thing of the past once the SMARTORK is installed
- ▶ Rated "Green" under Energy Efficiency guidelines
- ▶ 3rd party tests over one-million cycles with virtually constant torque verify extended service-life tests
- ▶ 2 year warranty
- ▶ Made in the USA
- ▶ Acts as a safety device by securing door lock mechanisms



CUSTOMIZABLE MULTI-KEY!

PART#: SEES-MULTI-KEY-001B



OTHER KEYS AVAILABLE FOR CUSTOMIZATION:

MIS-121

MIS-121A

MIS-122

ODO-46



Always Smooth Sailing

2781 West McNab Rd, Pompano Beach, FL 33069 • (800) 526-0026 • www.SEESinc.com



DO IT RIGHT THE FIRST TIME

"THE REQUIREMENTS FOR DOOR RESTRICTORS WAS IMPLEMENTED TO PREVENT PASSENGERS FROM FALLING INTO AN OPEN HOISTWAY UNDERNEATH THE ELEVATOR PLATFORM WHILE TRYING TO EVACUATE FROM AN ELEVATOR THAT IS STUCK BETWEEN FLOORS."

-AMERICAN SOCIETY OF MECHANICAL ENGINEERS

ELECTRICAL vs. MECHANICAL

Requires electric power & battery back up at all times.	vs.	Works even when power is out.
Coils burn up from continuous use.	vs.	Plastic edging protects wires & cables.
Functionality affected by severe temperatures (hot or cold).	vs.	Works in all types of weather conditions.
Required maintenance on plunger, battery, or PC Boards.	vs.	Maintenance Free!
Many false entrapments & call backs.	vs.	No Call Backs!
High Product Costs.	vs.	Lowest cost solution.

SEES RESTRICTOR: THE PREFERRED MECHANICAL DOOR RESTRICTOR



PART# SEES-RESTRICTOR-003
(FLAG SMALL ADJUSTABLE 1.25"-2")



PART# SEES-RESTRICTOR-004
(FLAG LARGE ADJUSTABLE 2"-2.875")



PART# SEES-RESTRICTOR-005
(SHIM KIT w/ HARDWARE)



PART# SEES-RESTRICTOR-006
(FLAG FIXED 1" LENGTH)



PART# SEES-RESTRICTOR-007
(FLAG FIXED 3" LENGTH)



Always Smooth Sailing



SOUTHERN ELEVATOR
& ELECTRIC SUPPLY





ALPHA TAGS



Application

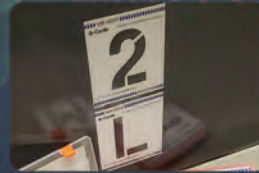
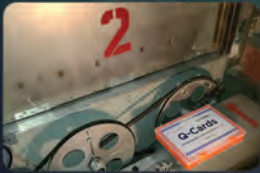

MAGNETIC ALPHA-NUMERIC STENCILS

CREATE A CLEAN, BEAUTIFUL LANDING MARKING FOR THAT FINISHING TOUCH ON A WELL BUILT ELEVATOR

DON'T DO ANOTHER JOB WITHOUT ALPHA TAGS



Convenient & Simple

Easily slap on the magnet and with spray paint or a large felt pen, safely mark your landings or equipment.



Easily transported

Stencils come in a compact hard-shell carrying case for safekeeping.



Better than Paper

No more fumbling around with paper stencils or a tape, these stencils allow for a faster hoistway marking experience and professional looking finish.



Kerning Gauge

A kerning gauge is included for uniform gaps between characters.

SEES Part#: Q-CARDS

**CODE
COMPLIANT**

**4.5" TEXT SIZE
MEETS 2.9 ID
REQUIREMENTS**

Always Smooth Sailing



SOUTHERN ELEVATOR
& ELECTRIC SUPPLY



SEES Inc



SEESParts

2781 West McNab Rd, Pompano Beach, FL 33069 • (800) 526-0026 • www.SEEInc.com

ESCALATOR

QUICK LOCATOR GUIDE

Fujitec	49-52
Chains, Seals Switches	50
Comb Plates, Steps, Demarcation Strips	51
Rollers	49
General Use Escalator Parts and Supplies	44-48
Skirt Safety Brush, Anti-Slide Knobs, Step Cleaner, Tools	
Handrails, Rollers, Signs, Lamps, Switches, Chains, Oilers	
Hitachi	54-56
Comb Plates, Rollers	54
Demarcation Strips, Steps	55
Sprockets	56
Hyundai	56-59
Comb Plates	58
Demarcation Strips	56-57
Rollers, Boards	57
Steps, Chains	59
Kone / Montgomery / O&K	66-78
Chains	70
Comb Plates	68-69
Rollers	66-67
LG	92-93
Mitsubishi	59-62
Rollers	59
Chains, Steps, Printed Circuit Boards	61
Comb Plates, Demarcation Strips	60
Light covers, Gears, Brakes, Motors	62
Otis	78-91
Rollers	78-79
Chains	90
Comb Plates, Steps, Demarcation Strips	80-86
Schindler / Westinghouse	96-114
Belts and Pulleys	108
Brake Parts	111
Chains and Sprockets	103-104
Combs Plates, Steps, Demarcation Strips	99-102
Motors, Transformers	110-111
Handrail	110
Rollers	96-98
Switches	105-107
Thyssenkrupp	94-95
SJEC	52-53
Toshiba	62-66
Comb Plates, Steps	63
Demarcation Strips, Joint Strips	64
Inlet Covers	65
Rollers	62



MIS-EB-101



MIS-EB-101A-EC



SEES-H20-ALARM-002E



MIS-ESCL-010

MIS-ESCL-1

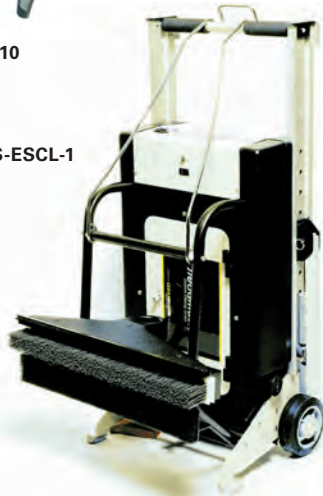

MIS-EST-001



MIS-EST-001M

Escalator Skirt Brush

S.E.E.S. #	Description
MIS-EB-101	Escalator Safety Dual Brush , This heavy duty deflector device meets safety code requirements worldwide and offers even more incentive to passengers to stay clear of escalator edges!
MIS-EB-101A	Escalator Skirt Brush , Single Brush with Aluminium Base, L = 2.4m
MIS-EB-101A-EC	End Cap , for MIS-EB-101A, Right Hand
MIS-EB-101A-EC-L	End Cap , for MIS-EB-101A, Left Hand

Escalator Flood Alarm

S.E.E.S. #	Description
SEES-H20-ALARM-002E	SEES Escalator Flood Alarm System , 110 VAC with bell and output

Anti-Slide Knob

S.E.E.S. #	Description
MIS-ESCL-010	Anti-Slide Knob , Escalator Puck 2-1/2" OD x 2" H with Toggle Bolt
MIS-ESCL-010-SPEC	Anti-Slide Knob , Escalator Special. Specify Dimensions
MIS-ESCL-011	Anti-Slide Knob , Escalator Dome 2-1/2" OD x 2" H with Toggle Bolt

Step Cleaner

S.E.E.S. #	Description
MIS-ESCL-1	Step Cleaner , Treadmaster escalator step cleaning machine 24" head 120 VAC
MIS-ESCL-2	Step Cleaner , Treadmaster escalator step cleaning machine 32" head 120 VAC
MIS-ESCL-3	Step Cleaner , Treadmaster escalator step cleaning machine 40" head 120 VAC
MIS-ESCL-4	Step Cleaner , Treadmaster escalator step cleaning machine 24" head 220 VAC
MIS-ESCL-5	Step Cleaner , Treadmaster escalator step cleaning machine 32" head 220 VAC
MIS-ESCL-6	Step Cleaner , Treadmaster escalator step cleaning machine 40" head 220 VAC
MIS-ESCL-7	Step Cleaner , Treadmaster 22" 120AC

Escalator Tools

S.E.E.S. #	O.E.M. #	Description
MIS-EST-001		Step Gauge Tool , for Escalator, Professional grade, aluminum
MIS-EST-001M		Step Gauge Tool , for Escalator, metric units, anodized aluminum
MIS-ESC-ACD		Escalator Anti-Climb Device , Clear Acrylic

Escalator Tools

S.E.E.S. #	O.E.M. #	Description
MIS-EST-002	14-300	Escalator Tool, Handrail removal
MIS-EST-003	KM50305098R01	Winch, Control Panel Lift Kit
OW-14	VP878095	Escalator Step Removing Tool, (Two required for safe step removal)
SEES-ISOP-002		SEES Isolation Pad, 1-1/2" Square x 1/8", Neoprene pad, 1/2" hole, set of 4

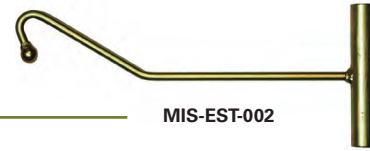

MIS-EST-002



OW-14

Handrails

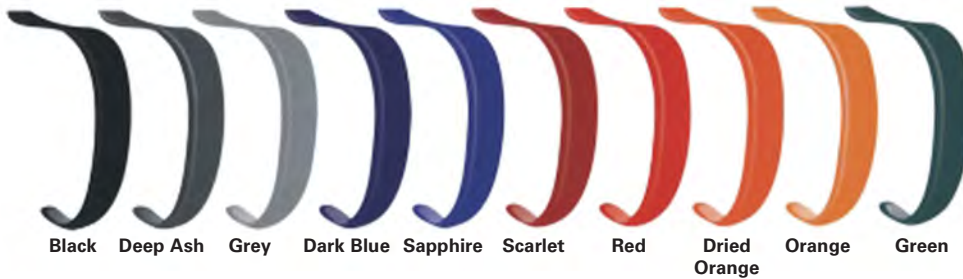

Black Deep Ash Grey Dark Blue Sapphire Scarlet Red Dried Orange Orange Green

Handrails

S.E.E.S. #	Model	Description
MISHR-1	XF	Handrail Height: H=33(±1), h=14. Width: DI=82(±2), D=64, d=35(+2).
MISHR-2	SWE	Handrail Height: H=34(±1), h=12. Width: DI=82(±2), D=62(±2), d=33(+3 -1).
MISHR-3	SDS	Handrail Height: H=28.5(±1.5), h=10.6(±0.8). Width: DI=80(+3-1), D=62(+3), d=39(+3). Brand: SDS.
MISHR-4	J	Handrail Height: H=27, h=10. Width: DI=8, D=62(+3), d=41(±1.5).
MISHR-5	OTIS	Handrail Height: H=35.5(±1), h=15.9(+0.5). Width: DI=82.5(+1.5-0.5), D=63.5(±0.5), d=38(+1.6).
MISHR-6	HITACHI	Handrail Height: H=27.5, h=10(+1). Width: DI=80(+1-0.5), D=63(+1.5), d=40(+2 -1).
MISHR-7	F/SW	Handrail Height: H=28.5(-1), h=10(+1.5). Width: DI=80(-1), D=63(+2), d=40(+2 -1)
MISHR-8	HYUNDAI	Handrail Height: H=28.4(±0.7), h=10.4(±0.7). Width: DI=79.3(±0.7), D=63.58(±0.7), d=39.6(+1.5 -0.7).
MISHR-9	LG	Handrail Height: H=31.7(+1), h=11.5(+1). Width: DI=81(+1.5), D=63(+1.5), d=40(+1.5).
MISHR-10	OTIS-800	Handrail Height: H=28(±1), h=9.5(+1). Width: DI=76(-2), D=60(-2), d=39(+2 -1).
MISHR-11	FT-300	Handrail Height: H=35(±1), h=15(+1). Width: DI=88(+4 -2), D=68(-2), d=40(+3 -1).
MISHR-12	SDG	Handrail Height: H=32(±1), h=12. Width: DI=86(±2), D=62(±2), d=36(+2 -1).

*measurements in millimeters

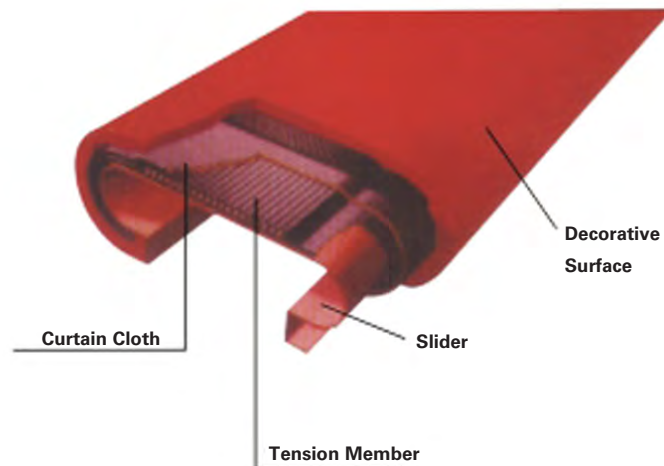
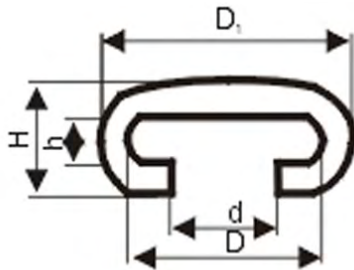



Rollers

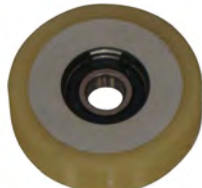

MISWH-1



MISWH-2



MISWH-3



MISWH-4



MISWH-5



MISWH-6



MISWH-7



MISWH-8



MISWH-9



MISWH-10

S.E.E.S. #	Description
MISWH-1	Roller, 76mm x 20mm, ID: 15mm, bearing 6202
MISWH-2	Roller, 70mm x 25mm, ID: 20mm, bearing 6204
MISWH-3	Roller, 80mm x 25mm, ID: 20, bearing 6204
MISWH-4	Roller, 80mm x 25mm, ID: 20.1mm
MISWH-5	Roller, Anti Deflection, 70mm x 25mm, bearing 6204
MISWH-6	Roller, 120mm x 30mm, ID: 17mm, double bearing 6203
MISWH-7	Roller, 80mm x 28mm, ID: 17mm, double bearing 6203
MISWH-8	Tach Wheel, 98mm x 30mm, ID: 17mm, double bearing
MISWH-9	Bottom Roller, 98mm x 31mm, ID: 17mm, bearing 6203
MISWH-10	Roller, central roller, ID: 35mm

Signs



S.E.E.S. #	Description
MIS-166G	Sign, Escalator Warning "CAUTION, Hold Handrail, Attend Children..." 4" x 7-1/2" Poly-vinyl, Self-adhesive
MIS-166G-1	Sign, Escalator Warning "CAUTION, No Strollers Permitted..." 4" x 7-1/2" Poly-vinyl, Self-adhesive
MIS-166T	Test Tag, Escalator (1 Year) 3-1/2" x 4" Aluminum Self-adhesive. Also available in rivet mount.
MIS-166W	Sign, Escalator Warning "CAUTION, Do not use as stairs" 4" x 7-1/2" Poly-vinyl, Self-adhesive



MIS-166G



MIS-166G-1

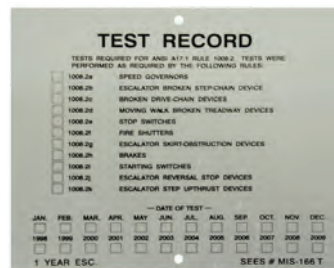

MIS-166T



MIS-166W



Escalator Lights

Demarcation Light Diffuser

S.E.E.S. #	O.E.M. #	Description
MIS-ESC-DLITE-A		Escalator Demarcation Box, LED, 115 VAC
MIS-ESC-DLITE-B		Escalator Demarcation Strip, LED, 24 VAC, Green, 18" x 1"
MIS-ESC-DLITE-C		Escalator Demarcation Strip, LED, 115 VAC, Green, 18" x 1"
ML-FLG-GREEN	S40	Fluorescent lamp guard, 4' long, green, (slit)



MIS-ESC-DLITE-A



ML-FLG-GREEN

Chain Oiler Kit

S.E.E.S. #	Description
MIS-ESC-001	Chain Oiler Kit, Motorized Dual Escalator Oiler for Drive Chains
MIS-ESC-001-1	Oil Throttle, for Each MIS-ESC-001
MIS-ESC-001-2	Tubing Connectors, for MIS-ESC-001B
MIS-ESC-001-3	Mounting Bracket, for MIS-ESC-001
MIS-ESC-001A LC120/1075	Oil Refill Kit, 120cc Includes Batteries
MIS-ESC-001B	Tubing, Oiler System For MIS-ESC-001, sold per foot
MIS-ESC-001C	Brush Replacement, Oiler Kit For MIS-ESC-001
MIS-ESC-001D	Replacement Motor, Oiler Kit With 120cc/1075 Oil Cartridge
MIS-SPOUT-OILER	Precision Spout Oiler, with All-Purpose Oil



MIS-ESC-001



SEES-SKIRT-SW-001



SEES-SKIRT-SW-002

Skirt Switches

S.E.E.S. #	O.E.M. #	Description
SEES-SKIRT-SW-001	PE0100710	Esc. Safety Skirt Switch, Left hand
SEES-SKIRT-SW-002	PE0100700	Esc. Safety Skirt Switch, Right hand
SEES-SKIRT-SW-003	PO7009A1	Esc. Safety Skirt Switch, Otis
SEES-SKIRT-SW-004		Esc. Safety Skirt Switch Set, Universal, L.H. and R.H.



SEES-SKIRT-SW-004

Chains

S.E.E.S. #	O.E.M. #	Description
MIS-CHA-35/50-BKR	CB-35/50	Chain breaker tool, #35 to #50
MIS-CHA-40		Roller chain, #40 riveted, 10' length
MIS-CHA-40-A		Chain link, #40 master link kit
MIS-CHA-40-B		Chain link, #40 offset half link kit
MIS-CHA-041		Courion Chain, #41
MIS-CHA-60		Roller Chain, #60 riveted, 10' length
MIS-CHA-60/100-BKR	CB-60/100	Chain breaker tool, #100 to #60
MIS-CHA-60-A		Chain link, #60 master link kit
MIS-CHA-60-B		Chain link, #60 offset half link kit
MIS-CHA-80		Roller chain, #80 riveted, 10' length
MIS-CHA-80-A		Chain link, #80 master link kit
MIS-CHA-80-B		Chain link, #80 offset half link kit
MIS-CHA-100		Roller chain, #100 riveted, 10' length
MIS-CHA-100-A		Chain link, #100 master link kit
MIS-CHA-100-B		Chain link, #100 offset half link kit



MIS-CHA-40



MIS-CHA-40-A



MIS-CHA-40-B



MIS-CHA-60



MIS-CHA-60 (closed)



MIS-CHA-60/100-BKR



MIS-CHA-60-A



MIS-CHA-60-B



MIS-CHA-80



MIS-CHA-80-A



MIS-CHA-80-B



MIS-CHA-100



MIS-CHA-100-A



MIS-CHA-100-B

FUJITEC

FUJITEC - Rollers & Wheels

S.E.E.S. #	O.E.M. #	Description
FUJ-022	C46036001	Roller Guide Handrail, Newel
FUJ-024	D62301001	Handrail return roller, 3-1/2" O.D.
FUJ-025	C62342001	Handrail return roller for Escalator, 2.36" O.D.
FUJ-026	C63060001	Step Roller for Escalator, 4-1/4" O.D.
FUJ-050	D62277001	Roller Assembly Chain, #80
FUJ-052	D62424001	Chain Roller for Escalator, 4.475" (12 mm) O.D.
FUJ-070	D6513001	Escalator Tach Wheel, 12" diameter for Tach #01039-2912
FUJ-076	G4003100	Escalator Step Roller, 80mm x23mm, 6202 Bearing
FJWH-1		Roller, 75mm x 23.5mm, ID:20mm, bearing 6204
FJWH-2		Roller, Nylon Hub, Dim 75mm x 23.5mm ID: 20.1mm, 75mm x 23.5mm
FJWH-3		Roller Assembly, Dim OD: 32mm
FJWH-4		Handrail press roller, 70mm x 75mm, 6004
FJWH-5		Handrail roller, nylon with aluminum, Black, 70mm x 50mm, 6204
FJFP-1		Handrail Drive Wheel, Dim OD: 440mm x 35mm
FJFP-2		Handrail Drive Wheel, Dim OD: 650mm x 30mm
FJFP-3		Friction Pulley, OD: 589mm x 306mm

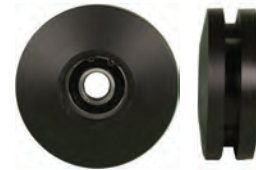

FUJ-024



FUJ-025

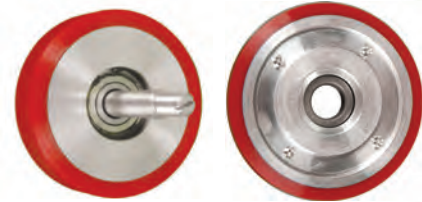

FUJ-026



FUJ-052



FUJ-070



FUJ-076



FJWH-1



FJWH-2



FJWH-3



FJWH-4



FJWH-5



FJFP-2



FJFP-3

FUJITEC - Lamps

S.E.E.S. #	O.E.M. #	Description
FUJ-030	D68127001	Demarcation Fluorescent Lamp for Escalator
FUJ-031	D68078001	Demarcation Fixture for Escalator
FUJ-032	D68125001	Demarcation Compact Lamp, 13W
FUJ-065	D6813001	Demarcation Lamp, 9 watt
FUJ-073	D6809901	Lamp, Geen LED 120 VAC



FUJ-030



FUJ-031



FUJ-032



FUJ-065



FUJ-027



FUJ-051



FUJ-054



FUJ-055



FUJ-066



FUJ-036



FUJ-061



FUJ-062



FUJ-010



FUJ-035



FUJ-051A



FUJ-053



HRP-2



FJIC-1L



FJIC-2

FUJITEC - Chains

S.E.E.S. #	O.E.M. #	Description
FUJ-027	D62280001	Sprocket, Fujitec Escalator Chain
FUJ-051	D62447001	Step Chain Shim, 0.1 mm (.004") .90" ID x 1.181 OD, brass
FUJ-051B		Step Chain Shim, .005" ID.9 OD 1.181 Brass
FUJ-051J		Step Chain Shim, .005" ID.9 OD 1.181 Brass
FUJ-054	D62277005	Handrail Drive chain assembly, #80
FUJ-055	D63056001	Step Chain shim for Escalator
FUJ-066	D62531001	Collar, Fujitec Step Chain
FUJ-077	D62451001	Esc Handrail Chain, #60, 178 Pitch
FJCH-1		Reversing Chain, Pitch Line: 60, Width: 34mm, Length: 1100mm, Single fork
FJCH-3		Roller Chain, Roller Dim 75mm x 23.5mm Roller 75mm x 23.5mm, T133.33
FJCH-4		Reversing Chain



FUJ-077



FJCH-3

FUJITEC - Switches

S.E.E.S. #	O.E.M. #	Description
FUJ-036	D65211001	Switch Cover, Escalator Emergency Stop
FUJ-060	C65129002	Limit Switch
FUJ-061	D63069001	Comb Impact Switch
FUJ-062	D65082001	Limit Switch for Escalator
FUJ-063	D65129001	Limit Switch for Escalator, R.H.
FUJ-064		Proximity Switch for Escalator
FUJ-075	D64094001	Limit Switch, Manual Reset, 1NO & 1NC

FUJITEC - Washers & Seals

S.E.E.S. #	O.E.M. #	Description
FUJ-010	D64411001/D64K2-672C1	Inner Rubber Molding
FUJ-035	C68K2-672A1	Baggage Stop, Escalator, 2" O.D., 1" Center to center, 1/4" 20 thread
FUJ-051A	D62447002S	Washer Set, Step Axle Shim
FUJ-053	D62453001	Shaft Seal, "V" notch

FUJITEC - Bracket

S.E.E.S. #	O.E.M. #	Description
HRP-2	00-070804-00	Escalator bracket

FUJITEC - Inlets

S.E.E.S. #	Description
FJIC-1L	Inlet Cover Grey, L=371mm, W=240mm, Thick=125mm
FJIC-2	Fujitec Rubber Inlet
FJIC-1R	Inlet Cover, Color: Grey, Length: 371, Width: 240, Thickness:125, Remark: Right

FUJITEC - Steps

S.E.E.S. #	O.E.M. #	Description
FJST-1		Aluminum Step
FJST-2		Aluminum Step with Demarcation Strip
FJST-3	C63136001	Escalator Step , Fujitec 40" W x 16" D

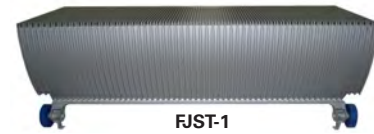

FJST-1



FJST-2

FUJITEC - Combs & Demarcation Strips

S.E.E.S. #	O.E.M. #	Description
FJYDS-1C	5P1P5582P001, 0129CAC001	Demarcation Strip , Length: 202.6mm, Tooth Pitch: 9.068, Thick Width: 49.5mm, Front
FJYDS-1L	5P1P5581P001, 0129CAA001	Demarcation Strip , Length: 402mm, Thick: 32.5mm, Width: 109mm, Left
FJYDS-1R	5P1P5581P002, 0129CAB001	Demarcation Strip , Length: 402mm, Thick: 32.5mm, Width: 96.6mm, Right
FJYDS-2C	0129CAC001	Demarcation Strip , Length: 203mm, Width: 49.5mm, Thick: 15.6mm, Tooth Pitch: 9.07, Front
FJYDS-2L	0129CAA001	Demarcation Strip , Length: 402.5mm, Thick: 33.5mm, Width: 109.2mm, Left
FJYDS-2R	0129CAB001	Demarcation Strip , Length: 402.5mm, Thick: 33.5mm, Width: 96mm, Right
FJCP-1C	0129CAD001	Comb Plate , Yellow Length: 199.4mm, Hole Spacing: 145mm, Tooth Pitch: 9.068, Remark: PC Center
FJCP-1R	0129CAF001	Comb Plate , Yellow Length: 202.9mm, Hole Spacing: 130mm, Tooth Pitch: 9.068, Remark: PC Right
FJCP-1L	0129CAE001	Comb Plate , Yellow Length: 202.9mm, Hole Spacing: 135.8mm, Tooth Pitch: 9.068, Remark: PC Left
FJCP-5C	0129CAP001	Comb Plate , Yellow Length: 199.4mm, Hole Spacing: 72.5mm, Tooth Pitch: 9.068, Remark: PC Center 3 Holes
FJCP-5R	0129CAS001	Fujitec Comb Plate , Yellow Length: 202.9mm, Hole Spacing: 65.8mm, Tooth Pitch: 9.068, Remark: PC Right 3 Holes
FJCP-5L	0129CAR001	Fujitec Comb Plate , Yellow Length: 202.9mm, Hole Spacing: 67.5mm, Tooth Pitch: 9.068, Remark: PC Left 3 Holes
FUJ-001	A405024C	Comb , 20 teeth left and center, yellow
FUJ-002	D63007002	Comb , 20 teeth right end, yellow
FUJ-008	D63051001	Comb plate , Stainless steel screw
FJST-4		Escalator Step , Fujitec

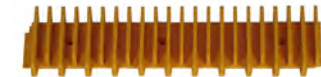

FJYDS-1C



FJYDS-1L



FJYDS-1R



FJYDS-2C



FJYDS-2L



FJYDS-2R



FJCP-1C



FJCP-1R



FJCP-1L



FJCP-5R



FUJ-001



FUJ-002

FUJITEC - Brush

S.E.E.S. #	Description
FJIC-3	Fujitec Brush



FJIC-3



FJDIS-1



FJBEA-1



FJBEA-2



FJCH-2



FJGL-2

FUJITEC - Misc. Parts

S.E.E.S. #	Description
FJDIS-1	Fujitec Indicator Panel
FJBEA-1	Sleeve
FJBEA-2	Gliding bushing
FJCH-2	Link
FJGL-2	Anti-deflection Plate

SJEC



SJWH-1



SJWH-2



SJWH-5



SJWH-3



SJWH-4

SJEC - Rollers

S.E.E.S. #	O.E.M. #	Description
SJWH-1		Roller, 100mm x 25mm, 6206 ID:30
SJWH-2		Roller, 100mm x 25mm, 6206 ID:20
SJWH-3	F01.FCCCA.0001A	Roller, 70mm x 25mm, 6204 ID:20
SJWH-4		Roller, 100mm x 25mm, 6204 ID:20
SJWH-5	F4011001	Roller, 100mm x 25mm, 6304 ID:20



SJCP-1L



SJCP-1C



SJCP-1R



SJCP-2

SJEC - Comb Plates

S.E.E.S. #	O.E.M. #	Description
SJFP-1		Friction Pulley, OD: 640mm
SJCP-1L	PX12171	Comb Plate, Length: 199.4mm, Height: 149.5mm, Hole Spacing: 145mm, Tooth Pitch: 9.068mm, Remark: Aluminum, Left
SJCP-1C	PX12161	Comb Plate, Length: 199.4mm, Height: 149.5mm, Hole Spacing: 145mm, Tooth Pitch: 9.068mm, Remark: Aluminum, Center
SJCP-1R	PX12172	Comb Plate, Length: 199.4mm, Height: 149.5mm, Hole Spacing: 145mm, Tooth Pitch: 9.068mm, Remark: Aluminum, Right
SJCP-2		Comb Plate, Length: 200mm, Height: 118mm, Hole Spacing: 145mm, Aluminum, 22 Teeth
SJCP-3		Comb Plate, Length: 200mm, Height: 105mm, Hole Spacing: 145mm, Plastic, 22 Teeth

SJEC - Inlet Covers

S.E.E.S. #	Description
SJIC-1	Inlet Cover , Color: Grey, Length: 292.9mm, Width: 115mm / 153mm, Thickness: 3mm
SJIC-2	Inlet Cover , Color: Black, Length: 496.4mm, Width: 162mm / 105.8mm, Thickness: 3mm



SJIC-1



SJIC-2

SJEC - Sensor

S.E.E.S. #	O.E.M. #	Description
SJSW-1	PR12-4DN	Autonics Inductive Proximity Sensor , Sensor Input: Inductive; Sensing Range: 0mm to 4mm; Supply Voltage Range DC: 12V to 24V; Frequency Response Max: 500Hz; Sensing Range Max: 4mm; Supply Voltage DC, Max: 24V

SJEC - Brake

S.E.E.S. #	O.E.M. #	Description
SJBRA-1	DZT-H	Jiangnan Express Brake , DZT-H 220V 0.3A >=400N



SJSW-1

SJEC - Chain

S.E.E.S. #	O.E.M. #	Description
SJCH-1		Handrail Tension Sheave Chain



SJBRA-1

SJEC - Steps and Pallets

S.E.E.S. #	O.E.M. #	Description
SJST-1		Sidewalk Pallet
SJST-2		Aluminum Step
SJST-3	YJ1000SX-	Stainless Steel Pallet , 110 teeth
SJST-4	YJ1000SX-	Stainless Steel Pallet , 120 teeth
SJST-5	F1701038	Step , Aluminum, A=800, 5 deges of plastic inserts, black, flat teeth, without center demarcation
SJST-6	F1701029	Step , Aluminum, A=800, 5 deges of plastic inserts, silver, projected teeth, without center demarcation
SJST-7		Step , 800mm, Sliver Al, Flat Teeth
SJST-8		Movingwalk Pallet , 1098mm x 140mm



SJCH-1



SJST-1



SJST-2

HITACHI



HIW-1



HIW-2



HIWH-3



HIWH-4



HIWH-5



HIWH-8



HIWH-12

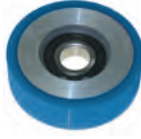

HWE-1



HWE-2



HWE-3



HI-ESC-001

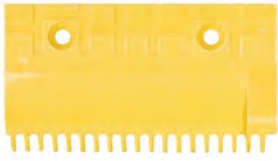

HI-ESC-002



HICP-1C



HICP-2C



HICP-2R



HICP-4C



HICP-4L

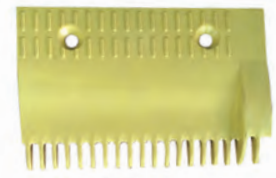

HICP-4R

HITACHI - Rollers

S.E.E.S. #	O.E.M. #	Description
HIW-1	H2202101	Roller , handrail driving roller 5.525" diameter with extended hub and .7874" bearing I.D.
HIW-2	H2221702	Roller , handrail roller 5.525" diameter with 2-1/8" mounting hole
HIWH-3		Roller , aluminum Hub 80mm x 23mm ID: 15mm, bearing 6202
HIWH-4		Step Roller , Iron Hub, 80mm x 29mm diameter, 6202 Double Bearing ID:15
HIWH-5		Roller , Iron Hub, 90mm x 60mm diameter, 6204, ID: 20mm
HIWH-8		Roller , Driving Roller, 141mm x 32mm, ID: 57
HIWH-12		Roller , Iron Hub, 80mm x 29mm, ID: 15mm, double bearing 6202
HIWH-13		Roller , Iron Hub, 90mm x 60mm diameter, 6202
HWE-1	97662	Escalator wheel for chain roller, 3-1/2" O.D. x 1-1/32" wide, .7874" bearing I.D.
HWE-2	97444, 93485	Step roller , 3" O.D. x 1" wide
HWE-3	80004	Step roller , 3-1/2" O.D. x 1-1/32" wide
HI-X7	9921485	Handrail Drive Roller Assembly , 21 tooth, 4 hole

HITACHI - Comb Plates

S.E.E.S. #	O.E.M. #	Description
HI-ESC-001	9921291	Comb Plate , center, yellow 142.8mm long
HI-ESC-002	9921308	Comb Plate , center, yellow 159.6mm long
HICP-1C	H2200116	Comb Plate , Yellow, Length: 142mm, Height: 90mm, Hole Spacing: 90mm, Tooth Pitch: 8.4mm, Remark: Plastic, 17 Teeth, Center
HICP-1L	H2200122	Comb Plate , Yellow, Length: 164mm, Height: 90mm, Hole Spacing: 90mm, Tooth Pitch: 8.4, Remark: Plastic, 19 Teeth, Left
HICP-1R	H2200124	Comb Plate , Yellow, Length: 164mm, Height: 90mm, Hole Spacing: 90mm, Tooth Pitch: 8.4, Remark: Plastic, 19 Teeth, Right
HICP-2C		Comb Plate , Yellow, Length: 200.7mm, Hole Spacing: 99mm Tooth Pitch: 8.7, Remark: Iron Base, Polyurethane, Center
HICP-2L		Comb Plate , Yellow Length: 163.5mm, Hole Spacing: 90mm Tooth Pitch: 8.7, Remark: Iron Base, Polyurethane, Left
HICP-2R		Comb Plate , Yellow Length: 163.5mm, Hole Spacing: 90mm Tooth Pitch: 8.7, Remark: Iron Base, Polyurethane, Right
HICP-3R	L47312017A&B	Comb Plate , right
HICP-3L	L47312018A&B	Comb Plate , left
HICP-3C	L47312013A, LDTJ-B-3	Comb Plate , middle
HICP-4R		Comb Plate , Right, Teeth 19
HICP-4L		Comb Plate , Left, Teeth 19
HICP-4C		Comb Plate , Middle, Teeth 17

HITACHI - Demarcation Strips

S.E.E.S. #	O.E.M. #	Description
HI-ESC-005	9920274	Demarcation Strip , yellow, 319-25.3mm
HI-ESC-006	9920304	Demarcation Strip , yellow, 319.43.3mm
HIYDS-1C	32188939-C	Demarcation Strip , Center
HIYDS-1L	LL27332044	Demarcation Strip , Left
HIYDS-1R	LL27332044	Demarcation Strip , Right
HIYDS-2F	LDTJ-A-16B	Demarcation Strip , front
HIYDS-2B	LDTJ-A-13	Demarcation Strip , rear
HIYDS-2L	L47332045A	Demarcation Strip , left
HIYDS-2R	L47332045B	Demarcation Strip , right
HIYDS-3A	H2106230	Demarcation Strip , Length: 411mm Thick:18.7mm Width: 24.7mm, Left
HIYDS-3B	H2106231	Demarcation Strip , Length: 411mm Thick:18.7mm Width: 24.7mm, Right
HIYDS-3C	H2106223	Demarcation Strip , Length: 319mm, Thick: 25mm Width: 25.3 mm, Back
HIYDS-3D	H2106211	Demarcation Strip , Length: 319mm, Thick: 25mm Width: 43.4mm, Front
HIYDS-5L	L47332114B	Demarcation Strip , black, left side
HIYDS-5R	L47332114B	Demarcation Strip , black, right side



HI-ESC-005



HIYDS-1C



HIYDS-1L



HIYDS-3A



HIYDS-3B



HIYDS-3C



HIYDS-3D

HITACHI - Steps

S.E.E.S. #	Description
HIST-1	Step , Stainless Steel Step 30/35 Degree Flat Tooth
HIST-2	Sidewalk Pallet
HICH-1	Step Chain , Pitch=68.4



HIST-1



HIST-2



HICH-1

HITACHI - Sprockets



HI-X1

S.E.E.S. #	O.E.M. #	Description
HI-X1	H2214449	Sprocket , handrail idler sprocket, 20 teeth, 3-3/8" O.D. with .7874" bearing I.D.
HI-X2		Sprocket , handrail dual sprocket, 22 teeth, 3.765" O.D. with .7874" bearing I.D.
HI-X3		Sprocket , handrail 5-3/8" O.D. 32 teeth with .7874" bearing I.D.
HI-X4		Sprocket , handrail drive sprocket, 4-5/8" O.D., 22 teeth, no bearing
HI-X5		Sprocket , handrail drive sprocket, 4-1/8" O.D., 25 teeth with .7874" bearing I.D.
HI-X6		Sprocket , handrail drive sprocket, 13-1/4" O.D., 54 teeth, no bearing



HI-X2



HI-X3



HI-X4



HI-X5



HI-X6



HI-X7

HYUNDAI

HYUNDAI - Demarcation Strips



HYYDS-1C



HYYDS-1D



HYYDS-2L



HYYDS-2R



HYYDS-3L

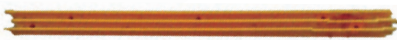

HYYDS-3R



HYYDS-4A



HYYDS-4B



HYYDS-4C



HYYDS-4L



HYYDS-6B



HYYDS-6A



HYYDS-4R



HYYDS-7A



HYYDS-6C



HYYDS-8A



HYYDS-8B

S.E.E.S. #	O.E.M. #	Description
HYSC-001		Hardware kit for Hyundai demarcation strips 5mm x 15mm O.L.
HYYDS-1A	HE645B023 HO	Demarcation Strip , Length: 200mm Thick: 26mm Width: 43.4mm Tooth Pitch: 9.068mm
HYYDS-1C		Demarcation Strip , Length: 411mm, Thick: 25mm, Width: 43.4mm, Thick: 18.4mm, Left
HYYDS-1D		Demarcation Strip , Length: 411mm, Thick: 25mm, Width: 43.4mm Thick: 18.4mm, Right
HYYDS-2L		Demarcation Strip , Left
HYYDS-2R		Demarcation Strip , Right
HYYDS-3L	L47332130A	Demarcation Strip
HYYDS-3R	L47332130B	Demarcation Strip
HYYDS-4A	H645B028H06	Demarcation Strip , C2 H06, 22T
HYYDS-4B	H645B028H05	Demarcation Strip , C2 H05, 24T
HYYDS-4C	H645B028H01	Demarcation Strip , C2 H01, 14T
HYYDS-4L	H645B029H02	Demarcation Strip , Left
HYYDS-4R		Demarcation Strip , Right
HYYDS-6A	S645C606H01	Demarcation Strip , Right 225mm x 25mm
HYYDS-6B	S645C606H01	Demarcation Strip , Left 225mm x 35mm
HYYDS-6C	S645C605H01	Demarcation Strip
HYYDS-7A	645B025H01	Demarcation Strip , Left
HYYDS-8A	L57332061A	Demarcation Strip , Left
HYYDS-8B	L57332199/03B	Demarcation Strip , Left

HYUNDAI - Demarcation Strips

S.E.E.S. #	O.E.M. #	Description
HYYS-56A	L57332056A	Demarcation Strip, 224mm x 14mm x 27mm
HYYS-60A	L57332060A	Demarcation Strip, 225mm x 36mm x 14mm
HUN-001	645B028H01	Demarcation Strip, 5" W, 14 teeth, yellow plastic
HUN-002	645B028H02	Demarcation Strip, 6-7/16" W, 18 teeth, yellow plastic
HUN-002S		Demarcation Strip, Yellow Plastic with Machined Slots, 18 Tooth
HUN-008	9940467	Demarcation Tail Strip, 6" L, 17 teeth, yellow
HUN-009	9940455	Demarcation Tail Strip, 7-7/8" L, 22 teeth, yellow
HUN-010	645B023H03	Demarcation Tail Strip, 7-3/16" L, 20 teeth, yellow
HUN-011	9940480	Demarcation Strip, 16" L, 16 teeth, R.H., yellow, (3) 6mm mounting studs
HUN-012	9940492	Demarcation Strip, 16" L, 16 teeth, L.H., yellow, (3) 6mm mounting studs
HUN-018	9941150	Demarcation Strip, New Escalator Style 800 & 1200 L/H
HUN-019	9941149	Demarcation Strip, New Escalator Style 800 & 1200 R/H

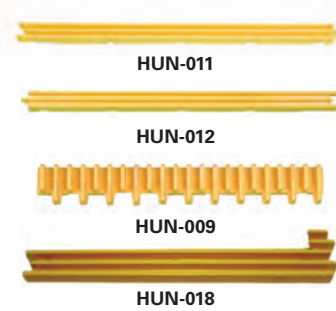
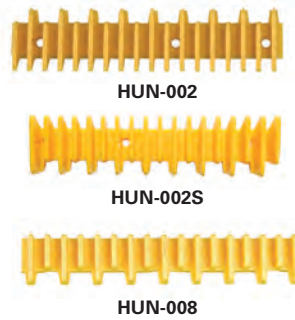

HYUNDAI - Rollers

S.E.E.S. #	O.E.M. #	Description
HYSR-001		Step Roller Rubber Sleeve 37.6mm O.D. x 34mm L x 15.6mm I.D.
HYWH-1		Roller, 76mm x 22mm, ID: 17mm, bearing 6203
HYWH-2		Driving Pulley, 135mm x 34mm, ID: 44.8mm
HYWH-3	S613C020	Handrail Roller, 87mm x 42mm, ID: 20mm, bearing 6204
HUN-020	613C001G01	Handrail Drive Roller, 5-1/4" O.D.
HUN-021	613002G02	Pressure and Step Roller, 3" O.D.



HYUNDAI - Boards

S.E.E.S. #	Description
HPC-001	PCB, MCU Hyundai
HPC-S17	PCB, Hyundai Relay

HYUNDAI - Comb Plates



HYCP-1C



HYCP-1L



HYCP-1R



HYCP-2C

S.E.E.S. #	O.E.M. #	Description
HYCP-1C	S655B6	Comb Plate , Color: Yellow Length: 160mm, Height: 92.2mm Remark: Plastic, 17 Teeth, Center
HYCP-1L	S655B6	Comb Plate , Color: Yellow, Length: 154.2mm, Height: 92.2mm, Remark: Plastic 13 Teeth, 3 Holes, Left
HYCP-1R	S655B6	Comb Plate , Color: Yellow, Length: 154.2mm, Height: 92.2mm, Remark: Plastic, 13 Teeth, 3 Holes, Right
HYCP-2C	HE655B013H06	Combo Plate , 16 Teeth, center
HYCP-2L	HE655B013H0	Combo Plate , 15 Teeth, left
HYCP-2R	HE655B013H0	Combo Plate , 15 Teeth, right
HYCP-3C		Comb Plate , T=9.125, 155mm × 92mm HD=107mm, Teeth 17
HYCP-3L		Comb Plate , T=9.125, 155mm × 92mm HD=80mm, Teeth 12
HYCP-3R		Comb Plate , T=9.125, 155mm × 92mm HD=89mm, Teeth 13
HUN-003	655B013H06/9940649	Comb , 5-3/4" W, 16 teeth, center 800 & 1200 series, Old Style, yellow
HUN-004	655B013H04/9940625	Comb , 6-1/4" W, 15 teeth, right hand 1200 series, Old Style
HUN-005	655B013H05/9940637	Comb , 6-1/4" W, 15 teeth, left hand 1200 series, Old Style
HUN-006	655B013H02	Comb , 6-1/4" W, 16 teeth, right hand
HUN-007	655B013H03	Comb , 6-1/4" W, 16 teeth, left hand
HUN-013	9941060	Comb , 6-1/4" W, 15 teeth L.H. 1200 series, New Style
HUN-014	9941095	Comb , 6-1/4" W, 16 teeth L.H. 1200 series, New Style
HUN-015	9941071	Comb , 6-1/4" W, 15 teeth R.H. 1200 series, New Style
HUN-016	9941101	Comb , 6-1/4" W, 16 teeth R.H. 800 series, New Style
HUN-017	9941083	Comb , 5-11/16" W, 16 teeth center 800/1200, New Style



HYCP-3C



HYCP-3L

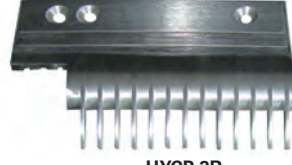

HYCP-3R



HUN-003



HUN-004



HUN-005



HUN-007



HUN-013



HUN-014

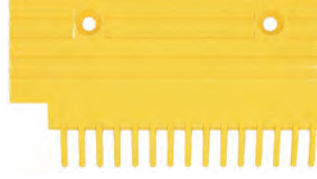

HUN-015



HUN-016



HUN-017

HYUNDAI - Steps & Step Chains

S.E.E.S. #	O.E.M. #	Description
HES-001		Drive Chain, Modular "B" Conv 130 Pitch L #60 with Offset & ML
HES-002		Roller Chain Assembly, Modular "B" Handrail Conversion Drive
HES-003		Houghton Esc Split Bushing
HYCH-1C		Step Chain
HYCH-1		Step Chain
HYCH-2		Step Chain, Old type
HYST-1	L42020030A	Step, Stainless Steel, 1200L L47332131A, 1200R L47332133A
HYST-2		Whole Aluminum Step
HYST-3		Sidewalk step
HYST-3		Sidewalk step
HYST-4		Hyundai step, 600mm Aluminum Model WBT2



HES-001



HES-002



HYCH-1C



HYCH-2

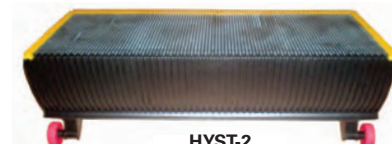

HYST-2



HYST-3

MITSUBISHI

MITSUBISHI - Rollers

S.E.E.S. #	O.E.M. #	Description
MIT-ESC-001	9902003S	Handrail idler wheel with sleeve
MIT-ESC-002	YS011C272f	Handrail drive wheel
MIT-ESC-003	9902005N	Handrail drive wheel
MIT-ESC-004	YS015D746	Follower wheel
MIT-ESC-005	A003001A	Step roller with axle
MIT-ESC-006	A003002N	Step roller
MIT-ESC-007	A003003N	Step roller
MIT-ESC-012	A007009N	Chain Guide Roller
MIWH-1		Guide Sheave
MIWH-4		Friction Roller
MIWH-5		Chain Roller
MIWH-7	YS005C520	Bearing Step Roller, 76mm x 25mm 6202 ID: 15mm
MIWH-13		Cleaning Roller, 83mm x 36mm
MIWH-16		Roller, 76mm x 25mm, ID:15mm, bearing 6202
MIWH-17		Iron Hub, 60mm x 55mm, ID:15mm, double bearing 6202
MIWH-18		Press Roller
MISWH-1		Roller, 76mm x 20mm, ID: 15mm, bearing 6202
MISWH-9		Bottom Roller, 98mm x 31mm, ID:17mm, bearing 6203
MISWH-10		Central Roller, ID: 35mm
MIGP-1		Gliding Bushing, ID: 25mm
MIGP-2		Gliding Bushing, ID: 25mm



MIT-ESC-002

MIT-ESC-006



MIT-ESC-007

MIT-ESC-012

MIWH-1



MIWH-4

MIWH-5

MIWH-7



MIWH-13

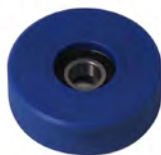

MIWH-16



MIWH-17



MIWH-18



MIGP-1



MIGP-2

MITSUBISHI – Escalator Parts

MITSUBISHI - Comb Plates

S.E.E.S. #	O.E.M. #	Description
MICP-1	YS013B578	Comb Plate , Yellow, Length: 126.9mm, Width: 92.4mm, Tooth Pitch: 9, Plastic, 14 Teeth
MICP-2		Comb Plate , Black, Length: 126.9mm, Width: 92.4mm, Tooth Pitch: 9, Plastic 14 Teeth
MICP-3	YS017B578	Comb Plate , Yellow, install hole=80mm
MICP-4	YS013B578	Comb Plate , Black, install hole=80mm
MICP-5	YS013B578	Comb Plate , Alluminum, 62mm distance between two holes



MICP-1



MICP-2



MIYDS-1



MIYDS-2



MIYDS-3



MIYDS-3A



MIYDS-4

MITSUBISHI - Demarcation Strips

S.E.E.S. #	O.E.M. #	Description
MIYDS-1	YS013B521-03	Demarcation Strip , Left
MIYDS-2	YS013B522-03	Demarcation Strip , Right
MIYDS-3	YS004B278-03	Demarcation Strip , Center
MIYDS-3A	YS000B079	Demarcation Strip , L=198mm, W=18mm
MIYDS-4		Demarcation Strip , Length: 413mm, Tooth Pitch: 18 Thick Width: 27mm, Left
MIYDS-5	J619000B202	Demarcation Strip , Length: 409mm, Thick: 13.6mm, Width: 103mm, Right
MIYDS-6	J619000B202	Demarcation Strip , Length: 409mm, Thick: 13.6mm, Width: 99mm, Left
MIYDS-7	J619000B203	Demarcation Strip , Length: 400mm, Tooth Pitch: 9.068
MIYDS-8		Demarcation Strip , Length: 413mm, Tooth Pitch: 18 Thick Width: 27mm, Right
MIYDS-41A	L47332141A	Demarcation Strip , for Stainless Steel Step
MIYDS-41B	L47332141B	Demarcation Strip , for Stainless Steel Step
MIYDS-42C	L47332142C	Demarcation Strip , for Stainless Steel Step
MIYDS-42D	L47332142D	Demarcation Strip , for Stainless Steel Step
MIYDS-43A	L47332143D	Demarcation Strip , for Stainless Steel Step
MIYDS-45A	L47332145A	Demarcation Strip , for Stainless Steel Step
MIT-ESC-017	YS013B522	Step riser , 1000mm, left
MIT-ESC-018	YS004B278	Step riser , 1000mm, center
MIT-ESC-019	YS013B521	Step riser , 1000mm, right



MIYDS-5



MIYDS-6



MIYDS-7



MIYDS-8



MIT-ESC-017



MIT-ESC-018



MIT-ESC-019

MITSUBISHI - Printed Circuit Boards

S.E.E.S. #	O.E.M. #	Description
MIPCB-80	YKOE0242	Printed Circuit Board
MIPCB-94	C731000B114	Printed Circuit Board, SUM630



MIPCB-80



MIPCB-94

MITSUBISHI - Steps

S.E.E.S. #	O.E.M. #	Description
MIST-1		Sidewalk Pallet
MIST-2	J619101A000G003	Step Strip, Stainless Steel
MIST-3	J619004A000	Aluminum Step, 21.5cm, Angle=30; J619000A201A/J619004A000
MIST-4	J619001A201	Aluminum Step, 24.5cm, Angle=35; J6019001A201B/ J6190003A000G03

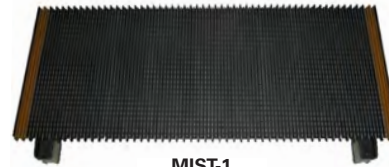

MIST-1

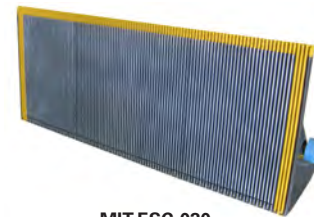

MIT-ESC-020

S.E.E.S. #	O.E.M. #	Description
MIS-ESC-020	A311003Z	Step Assembly, 1000mm, 30 degree
MIT-ESC-016	9911022Z	Step Assembly, 600mm, 30 degree

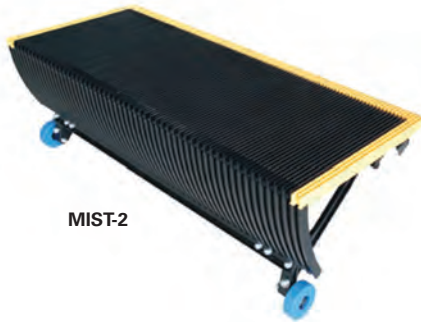

MIST-2

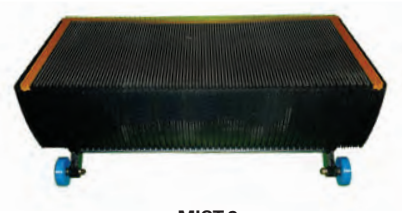

MIST-3

MITSUBISHI - Chains

S.E.E.S. #	O.E.M. #	Description
MIT-ESC-011	15J TSUBAKI	Step chain unit assembly
MIT-ESC-013	YS002A314 G02	Duplex chain with pick up roller
MIT-ESC-014	T6	Step chain unit
MIT-ESC-015	T67G	Step chain unit
MICH-1		Step Chain, Pitch=68.4, install hole=25mm, shafts distance=406.4mm
MICH-2		Step Chain, Pitch=68.4, install hole=27mm, shafts distance=406.4mm
MICH-3		Step Chain, 15J Pitch=68.4, install hole=22mm
MICH-4A		Driving Chain, roller width=38mm
MICH-4B		Driving Chain, roller width=42.5mm



MIT-ESC-013



MICH-1, MICH-2



MICH-3



MICH-4A



MICH-4B



MIG-1



MIG-2

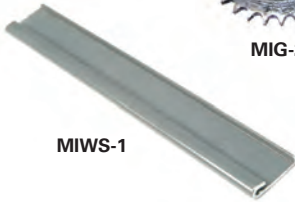

MIWS-1



MIBRA-1

MITSUBISHI - Light Covers

S.E.E.S. #	Description
MIHLC-1-BC	Handrail Light Cover, Button Curve
MIHLC-1-ST	Handrail Light Cover, Staight
MIHLC-1-TC	Handrail Light Cover, Top Curve

MITSUBISHI - Gears

S.E.E.S. #	Description
MIG-1	Gear Single, 22T
MIG-2	Gear with bearing, 30T

MITSUBISHI - Wearing Strip

S.E.E.S. #	Description
MIWS-1	Wearing strip

MITSUBISHI - Brake

S.E.E.S. #	O.E.M. #	Description
MIBRA-1	YS101B034-01	DHL Brake

MITSUBISHI - Motor

S.E.E.S. #	O.E.M. #	Description
MITM-1	S147R-13; 5.5KW	Motor, 50Hz, 11.8A

TOSHIBA



TOS-ESC-001



TOWH-1



TOWH-2



TOWH-7



TOWH-6



TOWH-5

TOSHIBA - Rollers

S.E.E.S. #	O.E.M. #	Description
TOS-ESC-001	9903003N	Escalator Step Roller
TOWH-1		Roller, Polyurethane, 70mm diameter x 25mm, ID: 20mm
TOWH-2		Roller, Iron Hub, 149mm diameter x 36mm, 6202 Double Bearing ID:15
TOWH-5		Roller Assembly
TOWH-6		Roller Assembly, Old style
TOWH-7		Roller, 70mm x 36mm, 6202 Double ID:15mm

TOSHIBA - Chain



TOCH-1

S.E.E.S. #	Description
TOCH-1	Handrail Tension Sheave Chain

TOSHIBA - Comb Plates

S.E.E.S. #	O.E.M. #	Description
TOS-ESC-010	9905001N	Comb , Dong Yang, die cast, center, 14 teeth
TOS-ESC-011	9905002N	Comb , Dong Yang, die cast, left, 14 teeth
TOS-ESC-012	9905026N	Comb , Dong Yang, die cast, right, sec, 14 teeth
TOCP-1C		Comb Plate , Length: 134.4mm, Hole Spacing: 86mm, Tooth Pitch: 8.4, Remark: Aluminum
TOCP-3R	5P1P5422P1	Comb Plate , Length: 199.5mm, Hole Spacing: 145mm, Tooth Pitch: 9, Remark: Aluminum, 22 Teeth, Left
TOCP-3C	5P1P5422P2	Comb Plate , Length: 206mm, Hole Spacing: 145mm, Tooth Pitch: 9.068, Remark: Aluminum, Center
TOCP-5A		Comb Plate , Color: Yellow, Length: 199.7mm, Hole Spacing: 145mm, Tooth Pitch: 8.5, Remark: Plastic, 22 Teeth
TOCP-5B		Comb Plate , Color: Yellow, Length: 205.6mm, Hole Spacing: 145mm, Tooth Pitch: 8.5mm, Remark: Plastic, 22 Teeth
TOCP-5B		Comb Plate , Yellow, Length: 199.7mm, Hole Spacing: 145mm, Tooth Pitch: 8.5, Remark: Plastic, 22 Teeth
TOCP-8		Comb Plate , Color: Yellow, Length: 202mm, Hole Spacing: 140mm, Tooth Pitch: 9, Remark: Plastic, 22 Teeth
TOCP-9C		Comb Plate , Color: Yellow, Length: 101mm, Hole Spacing: 51mm, Tooth Pitch: 8.4, Remark: Plastic, 12 Teeth Center
TOCP-13		Comb Plate , Color: Black Length: 115 Hole Spacing: 65 Tooth Pitch: 9.068 Remark: ABS 12 Teeth
TOCP-14R	5311P1	Comb Plate , Length: 199.5mm Hole Spacing: 145mm Tooth Pitch: 9.068 Remark: Aluminum Right
TOCP-14L	5311P3	Comb Plate , Length: 199.5mm Hole Spacing: 145mm Tooth Pitch: 9.068 Remark: Sidewalk Aluminum Left
TOCP-14C	5311P2	Comb Plate , Length: 204mm Hole Spacing: 145mm Tooth Pitch: 9.068 Remark: Sidewalk Aluminum Center
TOCP-15C	5P1P5171-1	Comb Plate , Black Length: 197.8mm Height: 152mm Hole Spacing: 145mm Tooth Pitch: 9.068 Remark: ABS 22 Teeth GTE
TOCP-15L	5P1P5171-2	Comb Plate , Black Length: 203mm Height: 152mm Hole Spacing: 145mm Tooth Pitch:9.068 Remark: ABS 22 Teeth GTE
TOCP-15R	5P1P5171-3	Comb Plate , Black Length: 203mm Height: 152mm Hole Spacing: 145mm Tooth Pitch:9.068 Remark: ABS 22 Teeth GTE

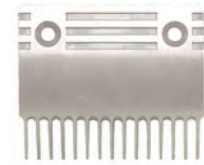

TOS-ESC-010



TOS-ESC-011



TOS-ESC-012



TOCP-1C



TOCP-3R



TOCP-3C



TOCP-5A



TOCP-5B



TOCP-8



TOCP-9C

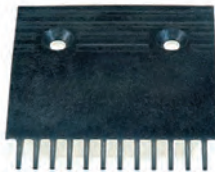

TOCP-13



TOCP-14C



TOCP-15C



TOST-1



TOSHIBA - Steps

S.E.E.S. #	Description
TOST-1	Step , Aluminum, With Demarcation (Riser Without Demarcation)



TOYDS-1



TOYDS-3



TOYDS-4



TOYDS-72A



TOYDS-72B



TOYDS-73A



TOYDS-74A



TOYDS-74B



TOYDS-75A



TOYDS-75B



TOYDS-76A

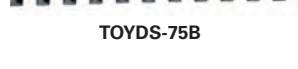

TOSHIBA - Demarcation Strips

S.E.E.S. #	O.E.M. #	Description
TOYDS-1		Demarcation Strip, Length: 202.6mm Tooth Pitch: 9.07 Width: 49.5mm
TOYDS-3		Demarcation Strip, Length: 308.6mm Tooth Pitch: 9 Width: 37.5mm
TOYDS-4		Demarcation Strip, Length: 403.5mm Tooth Pitch: Thick 25.7mm Width: 90.7mm
TOYDS-72A	L47332172A	Demarcation Strip
TOYDS-72B	L47332172B	Demarcation Strip
TOYDS-73A	L47332173A	Demarcation Strip
TOYDS-74A	L47332174A	Demarcation Strip
TOYDS-74B	L47332174B	Demarcation Strip
TOYDS-75A	L47332175A	Demarcation Strip
TOYDS-75B	L47332175B	Demarcation Strip
TOYDS-76A	L47332176A	Demarcation Strip



TOPP-1



TOPP-2



TOPP-3



TOPP-4



TOPP-5

TOSHIBA - Joint Strips

S.E.E.S. #	Description
TOPP-1	Joint Strip
TOPP-2	Joint Strip
TOPP-3	Joint Strip
TOPP-4	Joint Strip
TOPP-5	Joint Strip

TOSHIBA - Inlet Covers

S.E.E.S. #	Description
TOIC-5	Inlet Cover, Color: Black, Length: 287mm, Width: 103.5mm, Thickness:10
TOIC-6	Inlet Cover, Color: Black, Length: 287mm, Width: 202mm, Thickness: 10
TOIC-7	Inlet Cover, Color: Black, Length: 287mm, Width: 202mm, Thickness: 10



TOSHIBA - Rubber Parts

S.E.E.S. #	Description
TOP-9	Rubber Part
TORP-1	Rubber Part
TORP-10	Rubber Part
TORP-11	Rubber Part



TOSHIBA - Misc. Parts

S.E.E.S. #	Description
TOBEA-1	Shaft Seat
TORP-3	Fixing Part





TOSHIBA - Inlets

S.E.E.S. #	O.E.M. #	Description
TOIC-1	5PSC0005P1	Inlet Cover Black , Length: 132.5mm, Width: 110.5mm/80.5mm, Thickness:3mm
TOIC-2	5PSC0005P3	Inlet Cover Black , Length: 132.5mm, Width: 80.5mm/110.5mm, Thickness: 3mm
TOIC-4		Inlet Cover Black , Length: 287mm, Width: 103.5mm, Thickness: 10mm
TOIC-8	0215CBJ001	Rubber Inlet
TOIC-9		Rubber Inlet
TOIC-12		Rubber Inlet

KONE / MONTGOMERY



KONE / MONTGOMERY - Rollers

S.E.E.S. #	O.E.M. #	Description
ME-10	P16353 P22723	Wheel and Bracket Assembly , 2-3/4" O.D. x 15/16" W, 1/4" mounting holes 3-5/8" center to center
ME-10A	USP27652	Newel Roller Assembly , Ecowalk 3-3/4" C-C
ME-10B	USP32583	Newel Roller Assembly , Ecowalk 4" C-C
ME-11	A32885	Roller , Nylon handrail guide roller, 3" O.D. x 3-3/8" wide 1" I.D.
ME-11A	44412, P26936	Roller , Nylon handrail guide roller 3" O.D. x 2-3/4" wide with two bearings .7874" bearing I.D.
ME-11S		Escalator Roller Shaft , for ME-11 Handrail Roller
ME-12E	67036	Guide , HR, CRYST ESC, incline
ME-18	28834	Coupling , cushion
ME-19	USP27233	Step Roller Set , Flange Assembly 3-15/16" x 1-1/4" W x .7874" I.D. Set of 2
ME-20	USP27266	Step Roller Set , Flange Assembly 3-15/16" x 7/8" W x .7874" I.D., Set of 2
ME-20A	P29864	Step Roller Set , Spindle Assembly 3-15/16" x 7/8" W x .7874" I.D, Set of 2
ME-20B	USP32713001 USP27879	Step Roller , Spindle Assembly 3-15/16" x 1-1/4" W x .7874" I.D.
ME-20C	USP27166	Step Roller , 3" O.D. x 7/8" W, Flange Assembly
ME-27	US94653001	Switch , Roller / Plunger
ME-35	P26650	Tension Roller , Handrail Assembly, 4" O.D. x 7/16" W
ME-36	P27508	Roller Assembly , 2-13/16" diameter x 1-1/8" W, newel crystal
MW-3B	P5985	Step Roller , 3-15/16" x 1-1/8" x .7874" I.D.
MW-3C	P23230	Trail Roller , 3" x 7/8", .7874" I.D
KE-200	DEE2465357	Screw , Amtec-10.9-A1B
KE-201	69480-001	Bushing , Guide Wheel, Spacer
KE-202	16085-011	Snap Ring , Ext. .733" I.D. x 0
KE-203	68738-004	Screw , HSC/SK, Low, M6, L=16MM
KOCH-202	US69207003	Bushing , Step Guide, Outer (Replaces US42430)
KOWH-26	DEE2173045	Handrail Base Roller , Kone 60mm, 64mm 6204 Brg
KW-003	US33563002	Wheel , CWT R.G 3.937" O.D. Yellow
KW-004	US506872	Wheel , Door Clutch 2-1/4" O.D. Style T

KONE / MONTGOMERY - Wheels & Rollers

S.E.E.S. #	O.E.M. #	Description
KOCH-6		Roller, for Chain, 75mm x 23.5mm, T133.33
KOGS-1		Black Guide Shoe insert, 16mm
KOGS-2		Black Guide Shoe insert, 10mm
KOGS-11		Black Guide Shoe insert, 131mm x 22mm x 16mm
KOGS-17		Roller, Kone Guide Shoe Roller 195mm x 38mm x 2-6003
KOGS-18		Roller, Kone Guide Shoe Roller 80mm x 28mm x 2-6203
KOHB-2		Brush
KOWH-6	DEE4008753	Skeleton Roller, 100mm x 25mm diameter, 6204 ID:20
KOWH-7		Roller, Aluminum Hub 75mm diameter x 19mm, 6204 ID:20
KOWH-8		Roller, Iron Hub, 76.5mm x 32mm, 6203 ID: 17mm
KOWH-15		Roller Group, Distance Between Two Side Roller Centers: 467mm
KOWH-16		Roller, E3H
KOWH-24		Skeleton Roller, 100mm x 19mm, 6003 ID:17mm
KOWH-27	DEE4008754	Step Roller, 75mm x 23.5mm, 6204
KOWH-28	48865G01	Guide Roller
KOWH-1	KM650808G01	Tachometer Wheel, 37.3mm x 30mm ID:11mm
KOWH-1B		Tachometer Wheel, 75mm
KOWH-2		Tachometer Wheel, 75mm
KOWH-3	3685362	Roller, 75mm x 23mm ID: 20mm, bearing 6204
KOWH-4	3685360	Nylon Hub Roller, 75mm x 25mm ID:20.1mm
KOWH-5		Roller, 100mm x 19mm ID:20mm, bearing 6204
KOWH-10		Pressure Roller, L: 74mm, W: 60mm, bearing 6202
KOWH-11		Support Roller, L: 65mm, W: 76mm, Roller 60mm x 63.8mm
KOWH-12		Roller, L: 74mm, W: 69.5mm Roller: 60mm x 32mm
KOWH-13		Mid Roller, L: 80mm, W: 60mm, Roller: 60mm x 64mm
KOWH-14		Mid Roller, L: 90mm, W: 75mm, Roller: 60mm x 64mm
KOWH-17		Roller, 110mm x 19.3mm ID: 20mm, bearing 6204
KOWH-18		Roller, 80mm x 28mm ID: 17mm, double bearing 6203Z
KOWH-19		Roller, 30mm x 12mm, bearing 608Z
KOWH-21		Wheel, 50mm x 12mm GD: 43.5 ID: 10mm, bearing 6002
KOWH-22		Wheel, 48mm x 9mm 608 GD: 40 ID: 8mm
KOWH-23		Roller, L: 200mm W: 90mm ID: 70mm
KOWH-30		Roller, Handrail Guide
KOWH-201		Wheel, 1.5" O.D., Step Guide
KEW-001	USP27505	Kone Esc Wheel Assembly, Handrail take up
ME-59	P24811	Handrail Idler Roller, 3" O.D. x 2-1/4" W, 12 pins
ME-64	26936	Handrail Idler Roller without pins
ME-73	US519267	Step Roller, 4-3/8" O.D. x 1" W, bearing ID: .784"



KOWH-1

KOWH-2



KOWH-3

KOWH-4



KOWH-5

KOWH-6

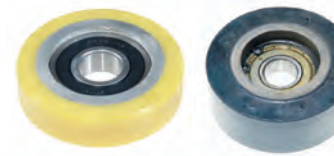

KOWH-7

KOWH-8

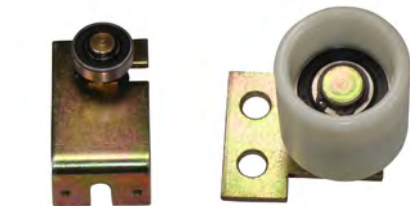

KOWH-10

KOWH-11

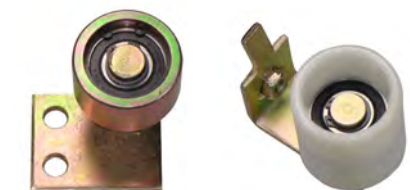

KOWH-12

KOWH-13



KOWH-14



KOWH-15



KOWH-17



KOWH-18



KOWH-27



KOWH-28



KOWH-30



KEW-001



ME-59



ME-64



ME-73



ME-13



ME-13A



ME-14



ME-14Y



ME-16



ME-16Y



ME-78



ME-82



ME-88A



ME-88D



ME-89A



KE-1



KE-209



KOC-11L



KOC-11C



KOC-11R



KOC-2C



KOC-2R



KOC-2L



KOC-3C

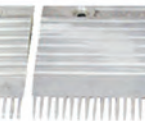

KOC-3R



KOC-3L

KONE / MONTGOMERY - Comb Plates

S.E.E.S. #	O.E.M. #	Description
ME-13	US68505005	Comb plate, center, 8-3/8" W, 25 teeth for 3E, 4E and 5E
ME-13A	US59827	Screw, mounting, for comb plates 5/16-18 x 5/8"
ME-13Y	B32484	Comb plate, yellow, center, 8-3/8" W, 25 teeth for 3E, 4E and 5E
ME-14	B46671	Comb plate, L.H., 8" W, 23-1/2 teeth, for 3E
ME-14Y	US68509005	Comb plate, yellow, as above
ME-15	B46670	Comb plate, R.H., 8" W, 23-1/2 teeth, for 3E & 4E
ME-15Y	US68508005	Comb plate, yellow, as above
ME-16	B46635	Comb plate, R.H., 7-5/8" W, 22-1/2, teeth for 5E
ME-16Y	US68507005	Comb plate, yellow, as above
ME-17	B46634	Comb plate, L.H., 7-5/8" W, 22-1/2 teeth for 5E
ME-17Y	US68506005	Comb plate, yellow, as above
ME-78	US69972005	Comb Plate, 7-5/8" W, 22 teeth, L.H., yellow aluminum
ME-82	US69955001	Comb plate, L.H. 21-1/2 teeth
ME-82A	US97177001	Comb plate, R.H. 21-1/2 Teeth 7W, Raw
ME-88A	US69182005	Comb Segment, Left Hand URH grey
ME-88C	US69181002	Comb Segment, 7-3/4" W, 23 teeth, center, yellow plastic
ME-88D	US69181005	Comb Segment, Center grey plastic
ME-89	US69183002	Comb Segment, 7-3/4" W, 23 teeth, L.H., yellow plastic
ME-89A	US69183005	Comb Segment, Grey LRH ULH plastic
KE-1	US516423H03	Comb plate, 4" W, 12 teeth, center
KE-2	US516423H02	Comb plate, 4" W, 12 teeth, L.H.
KE-3	US516423H01	Comb plate, 4" W, 12 teeth, R.H.
KE-209	69181-001	Comb plate, Middle, Black

S.E.E.S. #	O.E.M. #	Description
KOCP-11L	KM3711042	Comb Plate, Color: Yellow Length: 200.7 Hole Spacing: 99 Tooth Pitch: 9 Remark: Iron Base, 22 Teeth, Polyurethane
KOCP-11C	KM711044	Comb Plate, Color: Yellow Length: 197.4 Hole Spacing: 99 Tooth Pitch: 9 Remark: Iron Base, 22 Teeth, Polyurethane
KOCP-11R	KM3711043	Comb Plate, Color: Yellow Length: 200.7 Hole Spacing: 99 Tooth Pitch: 9 Remark: Iron Base, 22 Teeth, Polyurethane
KOCP-2C	KM5002052H01	Comb Plate, Length: 197.4 Height: 188.5 Hole Spacing: 99 Tooth Pitch: 9 Remark: Aluminum Center
KOCP-2R	DEE2209591	Comb Plate, Length: 202.7 Height: 188.5 Hole Spacing: 99 Tooth Pitch: 9 Remark: Aluminum Right
KOCP-2L	DEE2209592	Comb Plate, Length: 202.7 Height: 188.5 Hole Spacing: 99 Tooth Pitch: 9 Remark: Aluminum Left
KOCP-3L	3703287	Comb Plate, Length: 200 Height: 180 Hole Spacing: 99 Tooth Pitch: 9 Remark: Aluminum Left
KOCP-3C	3703280	Comb Plate, Length: 197.6 Height: 180 Hole Spacing: 99 Tooth Pitch: 9 Remark: Aluminum Center
KOCP-3R	3703288	Comb Plate, Length: 200.4 Height: 180 Hole Spacing: 99 Tooth Pitch: 9 Remark: Aluminum Right

KONE / MONTGOMERY - Comb Plates

S.E.E.S. #	O.E.M. #	Description
KOCP-4L	KM5009371H01	Comb Plate, 202" x 132" x 140", Black, Left
KOCP-4C	KM5009380H01	Comb Plate, 197" x 132" x 140", Black, Center
KOCP-4R	KM5009370H01	Comb Plate, 202" x 132" x 140", Black, Right
KOCP-5L	KM5009370H02	Comb Plate, 202" x 132" x 140", Yellow, Left
KOCP-5C	KM5009380H02	Comb Plate, 97" x 132" x 140", Yellow, Center
KOCP-5R	KM5009380H02	Comb Plate, 202" x 132" x 140", Yellow, Right
KOCP-11R	KM3711043	Comb Plate, Right, Eco 3000B
KOCP-11L	KM3711042	Comb Plate, Left, Eco 3000A
KOCP-11C	KM711044	Comb Plate, Center, Eco 3000C



KOCP-4L

KOCP-4C

KOCP-4R



KOCP-5L

KOCP-5C

KOCP-5R

KONE / MONTGOMERY - Switches

S.E.E.S. #	O.E.M. #	Description
ME-23A	P23625-601, P32309	Stop switch for escalator
ME-23	P13184	Cover, for stop switch, spring hinged 3" L x 2" W x 1/4" Thick
ME-23-BR-HELP		Lift Cover, Red with Braille "Help"
ME-23Y	P23893	Cover for emergency stop switch, yellow
ME-23Y-BLANK		Cover for emergency stop switch, yellow, blank
ME-26	44253	Switch for lower stations and front plate
ME-27	41129	Switch access cover
ME-27A	US94653001	Switch, Escalator Roller/Plunger Maintaining/Reset, 250 VAC

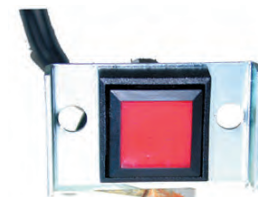

ME-23A (front)

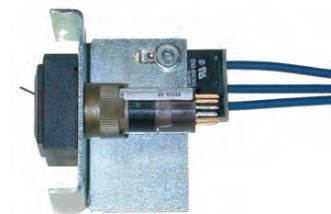

ME-23A (side)



ME-23



ME-23Y



ME-26



ME-27



ME-27A



ME-43



ME-53



KOCH-1



KOCH-2



KOCH-3



KOCH-4



KOCH-5



KOCH-6



KOCH-8



KOCH-10

KONE / MONTGOMERY - Chains

S.E.E.S. #	O.E.M. #	Description
ME-43	519726	Chain Clip, O&K
ME-53	300233-180	Belt Chain Key for Escalator
ME-75	67883	Chain set for single step Escalator
ME-76	67884	Chain set for 6-step matched escalator
ME-94	44789/67999	Chain, Master Link
KE-4	US94418102, USP34393001	Step chain, 24 pitch, matched pair, HR W
KOCH-1	DEE2758680	Reversing Chain, Pitch Line: 45mm Width: 30.5
KOCH-2	KM5071663G01	Reversing Chain, Pitch Line: 45 Width: 30.5
KOCH-3		Reversing Chain, Pitch Line: 46 Width: 32.5 - One
KOCH-4		Reversing Chain, Pitch Line: 45 Width: 30.5
KOCH-5	KM5130070G01	Tension Sheave Chain
KOCH-6		Chain Roller, 75mm x 23.5mm, T133.33
KOCH-8		Kone Link
KOCH-10	KM5070679G01	Reversing Chain with bearing
KOCH-201		Chain, HR DR, #50, 64.375", CL&OL
KOCH-202	US69207003	Bushing, Step Guide, Outer (Replaces US42430)
KOS-001	KM5072443H01	Kone, Spring R20



ME-28



ME-29



ME-30



ME-31



ME-56



ME-66



ME-67

KONE / MONTGOMERY - Switches

S.E.E.S. #	O.E.M. #	Description
ME-28	94708-015	Proximity Switch for Montgomery escalator
ME-29	37456	Switch for front plates and lower station
ME-30	44252	Switch for access covers, upper comb and skirts
ME-31	16486	Switch for skirts
ME-56	519926	Handrail Proximity Switch for Kone
ME-66	P24860	Handrail Proximity Switch for Escalator
ME-67	US94708-015	Proximity Switch, 12-24 VDC

KONE / MONTGOMERY - Demarcation Strips

S.E.E.S. #	O.E.M. #	Description
KE-204	DEE4004457	Demarcation Strip, L-197.5, Black
KE-205	DEE4004458	Demarcation Strip, L-189.8, Black
KE-206	DEE2145490	Demarcation Strip, L-197.5, Yellow
KE-213	DEE3704413	Demarcation Strip, L.H., Kone Crystal 5000, Yellow
KE-214	DEE3704414	Demarcation Strip, R.H., Kone Crystal 5000, Yellow



KONE / MONTGOMERY - Steps

S.E.E.S. #	O.E.M. #	Description
KOST-1	3000-80-35-2-4800	Escalator Step without Demarcation Strip, Silver, 800mm, E3C-80/35
KOST-2		Escalator Step, Kone 1000mm
KOST-3		Steel Step, Stainless
KOST-4	DEE1564237	Sidewalk Pallet
KOST-5	O&K KONE	O&K STEP
KOST-6	DEE1985530	Pallet Body, O&KTYPE80 B=805MM ROH FSC
KE-215	WK361020G01	Escalator Step Cap, Kone L.H.
KE-5	KM5070530H01	Skirt Light, Led Spot Light, White, 24 VDC
KET-001	US58176	Kone Escalator Tool, Clearance Gauge Imperial
KET-001M	KM51367636	Kone Escalator Tool, Clearance Gauge Metric

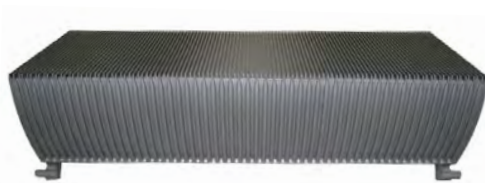

KOST-1



KOST-3



KE-5



KOST-4



KOST-6

KONE / MONTGOMERY - Lamps

S.E.E.S. #	O.E.M. #	Description
ME-37	519724	Skirt Lamp, O&K, 20 watt, 2' L
ME-57	2296612	Fluorescent Lamp for Kone, 20 watt, 2' L
ME-61	68144003	Demarcation Light Assembly see ME-74
ME-65	92219-001	Light Assembly, Double ballast
ME-72	68153-001/520069	Lamp
ME-74	MKR26GTG	Lamp (4) & green filter kit for ME-61



ME-37



ME-57



ME-61



ME-65



KONE / MONTGOMERY - Treads

S.E.E.S. #	O.E.M. #	Description
ME-1	B29102	Step tread, 16" L x 8" W, 24 treads, center
ME-2	B29104	Step tread, 16" L x 8" W, 24 treads, R.H.
ME-3	B29103	Step tread, 16" L x 8" W, 24 treads, L.H.
ME-3A	27917	Screw, 1-1/4", 6-32 for step treads
ME-3B	5304-50	Retaining Clip, 1/2", Bat Wing
ME-38	69465-004	Center Tread Insert for Escalator, 8-3/16" L, 24 treads, Silver
ME-40	69463-004	Left Hand Tread Insert, 16" L, L.H. Silver Flake
ME-58	69465-004	Step Tread Insert, 8-3/16" L, 24 treads
ME-63	US69464104	Tread Insert, 16" L, R.H., silver flake
ME-63A	US69464105	Tread Insert, 16" L, L.H., dark grey
ME-68	69464-001	Tread Insert, 16" L, R.H., black plastic
ME-68A	69465-101	Tread Insert, Black mid
ME-69	69463-001	Tread Insert, 16" L, L.H., black plastic
ME-69A	US69463102	Tread Insert, Yellow Plastic L.H.
ME-87	US69465102	Tread Insert, 8-3/16" L, 24 teeth, center, yellow
ME-93	64465-105	Tread insert, mid dark Gray

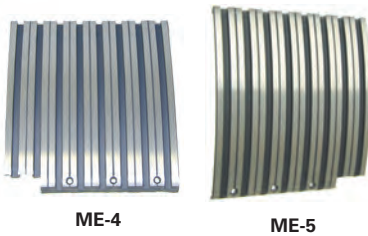

ME-4

ME-5



ME-62



ME-91C



ME-91D



ME-92



ME-49



ME-8



ME-9



ME-55



ME-98



ME-21



ME-22

KONE / MONTGOMERY - Risers

S.E.E.S. #	O.E.M. #	Description
ME-4	US59434002	Cleated Riser, L.H.
ME-5	US59433002	Cleated Riser, R.H.
ME-6	US29105002	Cleated Riser, center
ME-62	69461-004	Insert Riser, 8" L, silver, left hand
ME-62A	US69461105	Insert Riser, dark grey, L.H.
ME-91	69462101/69462001	Insert Riser, 8" L, R.H., silver flake
ME-91A	69462102/69462002	Insert Riser, 8" L, R.H., Yellow
ME-91B	69462103/69462003	Insert Riser, 8" L, R.H., Red
ME-91C	69462104/69462004	Insert Riser, 8" L, R.H., Silver flake
ME-91D	69462105/69462005	Insert Riser, 8" L, R.H., Dark Grey
ME-92	69461101/69461001	Insert Riser, 8" L, L.H., Black
ME-92A	69461102/69461002	Insert Riser, 8" L, L.H., Yellow
ME-92B	69461103/69461003	Insert Riser, 8" L, L.H., Red
ME-92C	69461104/69461004	Insert Riser, 8" L, L.H., Silver flake
ME-92D	69461105/69461005	Insert Riser, 8" L, L.H., Dark Grey

KONE / MONTGOMERY - Seals

S.E.E.S. #	O.E.M. #	Description
ME-9	P15363	Seal and Shim Kit, for gear box P-15
ME-9A		Seal and Shim Kit, for gear box
ME-49	30024	Retainer Seal, BG/GB left
ME-51	37455	Retainer Seal, BG/GB right
ME-55	15363	Shaft Oil Seal for Escalator
ME-98	18150	Gasket, Casehead, 8" x 8"
ME-21	A32926	Support curve, Novatex board 35-3/8" L
ME-22	59259	Support, Novatex board

KONE / MONTGOMERY - Inlet Parts

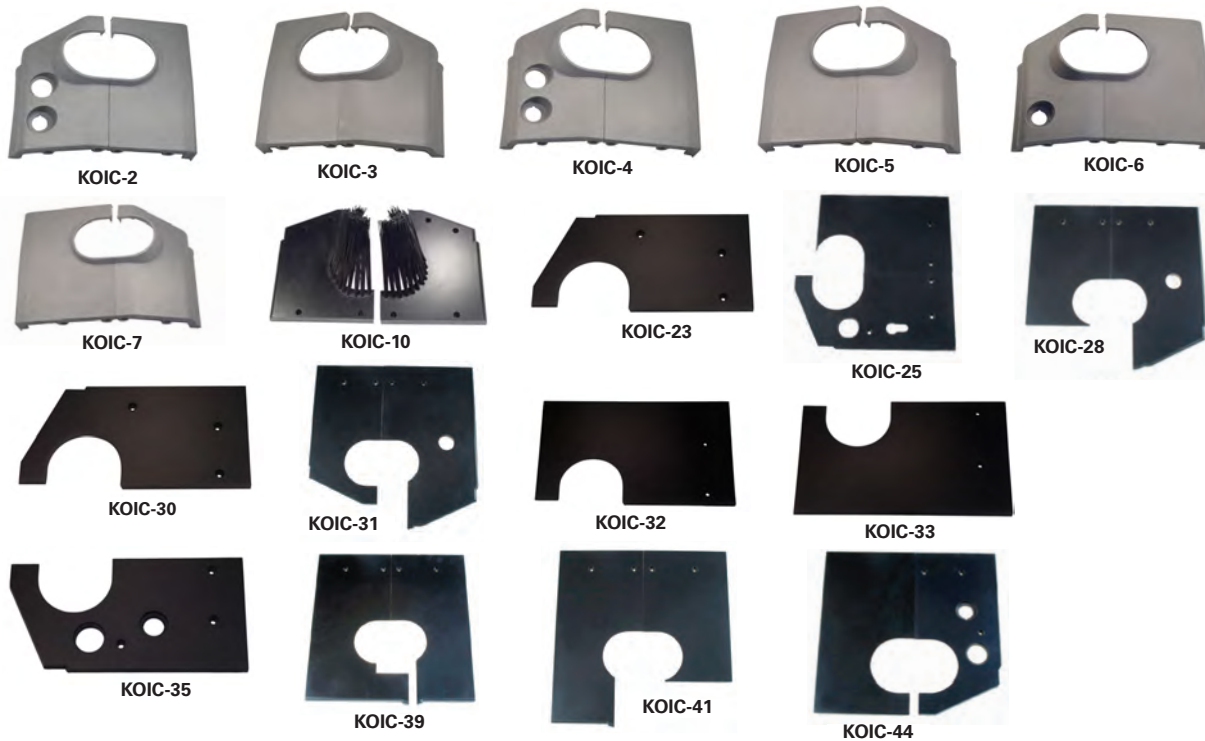

S.E.E.S. #	O.E.M. #	Description
KOST-1	3000-80-35-2-4800	Escalator Step without Demarcation Strip, Silver, 800mm, E3C-80/35
KOST-2		Escalator Step, Kone 1000mm
KOIC-2	5072734D10, 5072740D10	Inlet Cover Grey, Length: 216mm, Width: 130.5mm/126.5mm Right
KOIC-3	5072733D10, 5072730D10	Inlet Cover Grey, Length: 216mm, Width: 130.5mm/126.5mm Left
KOIC-4	5072735D10, 5072740D10	Inlet Cover Grey, Length: 216mm, Width: 130.5mm/141.5mm Right
KOIC-5	5072733D10, 5072731D10	Inlet Cover Grey, Length: 216mm, Width: 130.5mm/141.5mm Left
KOIC-6	5072738D10, 5072736D10	Inlet Cover Grey, Length: 216mm, Width: 130.5mm/165mm
KOIC-7	5072733D10, 5072732D10	Inlet Cover Grey, Length: 216mm, Width: 130.5mm/165mm
KOIC-10		Inlet Cover Black, Length: 304.9mm, Width: 169mm, Thickness: 10mm
KOIC-30	4001875	Inlet Faceplate, Black
KOIC-32	4001876	Inlet Faceplate, Black, Length: 262mm, Width: 155mm, Thickness: 10mm
KOIC-33	4007877	Inlet Faceplate, Black, Length: 262mm, Width: 155mm, Thickness: 10mm
KOIC-35	4001872	Inlet Faceplate, Black, Length: 263mm, Width: 126mm, Thickness: 10mm
KOIC-21	4001871	Inlet Faceplate, Black, Length: 263mm, Width: 130mm, Thickness: 10mm
KOIC-23		Inlet Faceplate, Color: Black, Length: 262, Width: 130, Thickness: 10
KOIC-25		Inlet Faceplate, Color: Black
KOIC-28		Inlet Faceplate, Color: Black
KOIC-31		Inlet Faceplate, Color: Black
KOIC-39		Inlet Faceplate, Color: Black, Remark: Combined Faceplate
KOIC-41		Inlet Faceplate, Color: Black
KOIC-44		Inlet Faceplate, Color: Black

KONE / MONTGOMERY - Brushes

S.E.E.S. #	O.E.M. #	Description
KOIC-48	13804015	Inlet Brush
KOIC-49		Inlet Brush
KOIC-50		Inlet Brush
KOWH-200	94572-001	Bearing, for Newel Roller, 5MMX19MMX6M
ME-34	29325-00A	Handrail Inlet Brush
KOIC-51	DEE4001877	Inlet Brush



KONE / MONTGOMERY - Misc. Hardware

S.E.E.S. #	O.E.M. #	Description
MHDW-001	28974	Snap Ring, External, 510
MHDW-002	59826011	Screw, 10-32 x 1-1/5" L Oval Phillips Head
MHDW-003	16085053	Snap Ring, External .460" diameter
MHDW-004	65349-022	Stud Receiver, Flat .175"
MHDW-005	46663	Clip Ring
MHDW-006	44875	Nut, Speed captive
MHDW-007	46662-003	Nut, #6 K-Lock Zinc Plated
ME-18A	34925	Washer, for Brake Cusion, .64" O.D.
ME-24	37598	Screw for access cover, 1/2" x 2"
ME-24A	59892	Screw for access cover, 3/8" x 2-1/2"
ME-25	59826	Screw, S.S. Phillips machine 10/32 x 1.5"
ME-25A	59892	Nut for stainless trim
ME-25B	US27917	Screw, socket head cap screw for step tread 6/32 x 1"
ME-25C	US68751002	Screw, Hex Drive hd mach screw
ME-25D	49282-009	Screw, Flat/SL, 8-32 Thread
ME-42	49399-003	Screw for Escalator
ME-44	61080-014	Screw for Escalator
ME-45	48839-003	Hex Nut
ME-46	61690-012	Screw for Escalator, dog point
ME-47	47401-009	Screw for Escalator, hex nut
ME-48	59333-001	Hex Nut for Escalator
ME-49	30024	Retainer Seal, BG/GB left
ME-50	44276/22216	Spherical Bearing for Escalator
ME-52	30022	Bearing Spacer for Escalator, 746
ME-54	61219-012	Screw set for Escalator, CP/SK
ME-79	US16085053	Snap Ring
ME-80	US69727001	Nut for Montgomery escalator
ME-81	US67854	Spacer
ME-83	US67071	Retaining Bearing, newel crystal
ME-84	US58351	Spring clip, inner panel
ME-200	68228-002	Nut, Hex Flange, Lock, Grade 5, 8-32 Thread (Replaces US48994)
KOWH-200	94572-001	Bearing, for Newel Roller, 5MMX19MMX6M
KE-207	67436-001	Sleeve, for Step Axle End
KE-208	CLU9-0045	Shim, 16 GA HRS
KE-210	US69819002	Stub Shaft, Middle, Black
KE-211	US68460001	Nut, Lock 1/2-13
KE-212	US93182001	Spacer, Tube Shaft for Step Adaptor
KOBE-1	DEE3721645	Belt, L-2500mm W-29mm Thickness-8mm

KONE / MONTGOMERY - Handrails

S.E.E.S. #	O.E.M. #	Description
ME-12	US60263010	Handrail Guide, polyguide, 13' L
ME-12A	P7395	Guide, Step polyguide
ME-12B	US67282	Handrail Guide, Incline, SEC
ME-12C	US67106	Handrail Guide for Escalator
ME-12D	US69161001	Handrail Guide, E5000
ME-86	US60440	Guide, newel, MOD 4000, 5000
ME-86A	US60510	Handrail Guide, stop, standard
ME-86B	US46716	Handrail Guide, support return
ME-90	US519434	Roller Handrail, 4-5/8" Dia. x 1-1/2" W, groove width for 1", bearing ID: .687"
MW-9D	67036	Guide, handrail, escalator, incline
KOGL-2		Anti Deflection Plate
KOGL-4		Guide Piece



KONE / MONTGOMERY - Misc. Parts

S.E.E.S. #	O.E.M. #	Description
ME-32	35981	Tach generator, 24V, 1500 RPM, Flange Mount
ME-33	29442	Step shim tool
ME-60	519766	Shim, 1.5mm, O&K
ME-61A	68149-001	Starter, for class 2 Demarcation Replaces US508575
ME-70	19501-1080	Belt fractional HP
ME-95	57922	Track, Flat 1-1/4" x 1-1/2" for escalator
ME-97	US58214	Timer, 1.5 S, Delay-On, 230 VAC, 1A
ME-99	P-32743-001	Brake, 8.25", magnet, 90V
ME-99A	P-32894-002	Caststep ASM, with Box, 5E, Alum
ME-201	94459-001	Axle, for Roller Guide, Handrail
KW-001	KM3689873	Guide, 10mm glass (replaces DEE3713311)
KW-002	KM3691814	Clip, Fastening
MIS-700		Wheel Puller for escalator wheels MW-3C, P23230 and MW-3, P12963
KET-001	US58176	Kone Escalator Tool, Clearance Gauge Imperial
KET-001M	KM51367636	Kone Escalator Tool, Clearance Gauge Metric
KOCH-7	KM5070648H01	Kone Link, 47mm x 16mm
KOIC-46		Skirt Bar
KONT-1		Iron Parts
KONT-2		Iron Parts
KOPP-1		Protective Plate
KOPP-2		Protective Plate
KOPP-3		Protective Plate
KOPP-4		Skirt Bar
KOPP-5		Stopper
KOPP-6		Stopper
KOPP-7		Joint Strip, (3 Holes)
KOPP-8		Joint Strip, (2 Holes)



ME-32



ME-33



ME-61A



KW-001



ME-201



KW-002



MIS-700



KOCH-7



KOIC-46



KONT-1



KONT-2

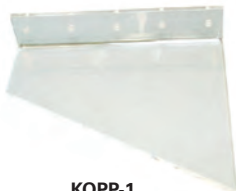

KOPP-1



KOPP-2



KOPP-3



KOPP-4



KOPP-5

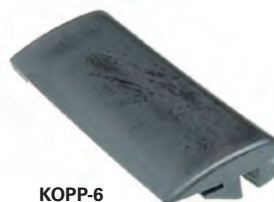

KOPP-6



KOPP-7

KONE / MONTGOMERY - Misc. Parts



S.E.E.S. #	O.E.M. #	Description
KOBEA-1	DE70101	Rubber Bush
KOBEA-2	DEE2258672	Slide Bushing, Axle Sleeve, D30mm L=45mm
KOBEA-11		Sleeve
KOCAB-1	KM5072999H01	Nylon Part
KOCAB-2	KM5072998H01	Nylon Part
KOCAB-3		Nylon Part, OD: 20mm / 12.5mm
KOCAB-4		Nylon Part
KOCAB-5	KM5052095	Fastening Clip, 30mm × 20mm × 11mm, PA 6.6
KOCAB-6		Clip
KOGL-1		Anti Deflection Plate
KOGL-2		Anti Deflection Plate
KOGL-3		Anti Deflection Plate
KOGL-5		Anti Deflection Plate





O&K-ESC-100



O&K-ESC-101



O&K-ESC-102

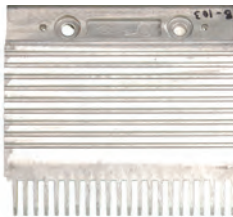

O&K-ESC-103



O&K-ESC-104



O&K-ESC-105

KONE / MONTGOMERY / O&K

KONE / MONTGOMERY / O&K - Escalator Combs

S.E.E.S. #	O.E.M. #	Description
O&K-ESC-100	DEE1718890	Escalator comb, 7-3/4" W, 22 teeth, center, metal finish type RTK-A4, R.H.
O&K-ESC-101	DEE1718891	Escalator comb, 7-15/16" W, 22 teeth, L.H., metal finish type RTK-B4
O&K-ESC-102	DEE1718892	Escalator comb, 7-3/4" W, 22 teeth, center, metal finish type RTK-C4 Center
O&K-ESC-103	DEE2209591	Escalator comb, 8" W, 22 teeth, L.H., metal finish type RTV-B
O&K-ESC-104	DEE2209592	Escalator comb, 8" W, 22 teeth, R.H., metal finish type RTV-A
O&K-ESC-105	DEE2209590	Escalator comb, 7-3/4" W, 22 teeth, center, metal finish type RTV-C
O&K-ESC-106	US519566	Escalator comb, metal yellow finish Type RTK-B L.H.
O&K-ESC-107	US519663	Escalator comb, metal yellow finish Type RTK-B R.H.
O&K-ESC-108	US519571	Escalator comb, metal yellow finish Type RTK-B CNTR

KONE / MONTGOMERY / O&K - Wheel

S.E.E.S. #	O.E.M. #	Description
ME-39	69006-002	Escalator Wheel, O&K, 1.5" O.D., .38" I.D. .5" H
O&KEW-001		O&K Step Roller, 110mm x 27mm x 20mm (6204 Brg)
O&K-ESC-004	DEE3646651	Roller, Escalator Step chain Alt# 32-06-1114
O&K-ESC-005	KM960895	Roller, Escalator Step tralling Alt# 32-06-1115



ME-39

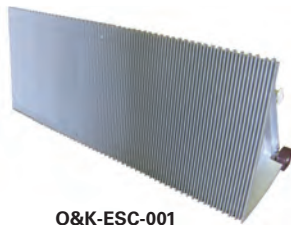

O&K-ESC-001



O&K-ESC-003



O&K-ESC-020



O&K-ESC-012



O&K-ESC-040

KONE / MONTGOMERY / O&K - Misc. Parts

S.E.E.S. #	O.E.M. #	Description
O&K-ESC-001	DEE1701757	Escalator Step with roller, 1000mm
O&K-ESC-002	DEE4004952	Escalator Step with roller, 800mm
O&K-ESC-003	A107019Z	Chain and Roller Assembly, O&K newel
O&K-ESC-006		Escalator Step, O&K with 110mm Roller
O&K-ESC-012	0002796	Escalator contactor K-14
O&K-ESC-013	DEE404837	Chain Assembly, O&K 10 Roller Step 22HDV-C 4000LG 2 Strand Set
O&K-ESC-014	DEE107432	Comb Screw, M4 X 10 Oval Phil HD Steel Ni PL DEE0107432
O&K-ESC-020	8243-402K	Relay, 250 VAC, 10amp
O&K-ESC-040	0002666, US520154	Tension Switch, O&K
O&K-ESC-200		Locking Plate, O&K
ME-41	3692320	Screw for Comb plate, O&K escalator, M8 x 16 slot

Otis

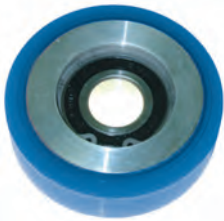

OW-5

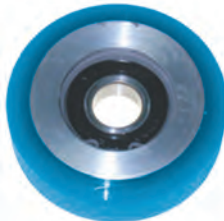

OW-5A

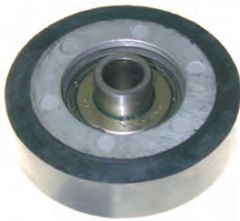

OW-5B



OW-5C

OTIS - Rollers

S.E.E.S. #	O.E.M. #	Description
OW-5	290AJ2	Escalator Roller, 3" O.D. x 7/8" wide, Polyurethane tire, .750" bearing I.D. 3/4" surface
OW-5A	290BP4	Escalator Roller, 3" O.D., 7/8" wide, 3/4" tire surface, alum. die cast, .6993" I.D., for Model 32R & 48R escalators
OW-5B	290BR2	Escalator Roller, 3" O.D. x 7/8" wide, polyurethane tire, same as OW-5, but with 1/2" bearing I.D.
OW-5C	GAA290CF2, 290AJ4	Escalator Roller, 3" OD x 7/8" wide, 3/4" surface, Urethane encapsulated bearing, .6693" I.D.
OW-22	290F1Y-SV	Step Chain Roller with poly tire, for "ML-C" escalator, 5-1/2" O.D., 1-1/2" wide, 1-1/8" tire face, 1-1/2" I.D.
OW-26	290CA2	Escalator Roller for Otis, 3" diameter x 3/4" wide
OW-31	RR6858, 25030604	Escalator Roller, Renold/Otis 4" OD 1" Face, .7874" I.D., 6304 Bearing



OW-22



OW-26

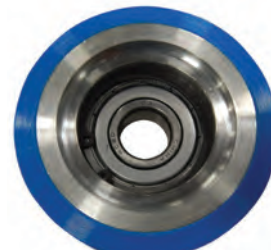

OW-31

OTIS - Rollers

S.E.E.S. #	O.E.M. #	Description
OW-41		Roller, 50mm x 15.25mm x 10mm 6200-2RS
OW-41A		Roller, 50mm x 16.75mm x 10mm 6200-2RS
OTWH-2		Iron Roller, 70mm x 36mm ID: 15mm
OTWH-3	GAA456DJ	Nylon Roller, 70mm x 34mm ID: 12mm, bearing 6201
OTWH-5		Roller, 80mm x 25mm ID: 30mm, bearing 6206
OTWH-5D		Roller, 80mm x 25mm ID: 30mm, bearing 6206
OTWH-6		Roller, 80mm x 25mm ID: 20mm, bearing 6204
OTWH-7		Roller, 80mm x 25mm ID: 20mm, bearing 6304
OTWH-8		Roller, for Hanger Nylon Hub 76.2mm x 21.4mm ID:19.1
OTWH-9		Nylon Hub Roller, 76.2mm x 21.4mm ID: 21mm
OTWH-10		Nylon Hub Roller, 80mm x 25mm ID: 21mm
OTWH-11		Roller, 80mm x 25mm, ID: 20mm, bearing 6204
OTWH-12		Roller, 80mm x 25mm, ID: 25mm, bearing 6205, Alum. hub
OTWH-13		Roller, Iron hub 130mm x 30mm ID: 25mm, bearing 6205
OTWH-14		Roller, 70mm x 25mm ID: 20mm, bearing 6204
OTWH-19		Roller, 76mm x 22mm ID: 17mm, bearing 6203
OTWH-20	506 NCE	Roller, 76.2mm x 22mm D: 17mm, bearing 6203
OTWH-21		Handrail Drive Wheel, XIZI OTIS 131mm x 34mm ID:44mm
OTWH-22		Handrail Roller, 76mm x 53mm ID:12mm, double bearing 6201
OTWH-23		Roller, 80mm x 25mm, 6203 ID:17mm GD:56. 4 Belt Roller
OTWH-24		Roller, 76.2mm x 21.6mm, ID:12.7mm, bearing 6203
OTWH-24A		Roller, 76.2mm x 21.6mm, ID:15.1mm, bearing 6203
OTWH-25		Chain Roller, 76.2mm x 21.6mm, ID:12.7mm, bearing 6203
OTWH-25A		Chain Roller, 76.2mm x 21.6mm, ID:15.1mm, bearing 6203
OTWH-26		Skeleton Roller, 76.2mm x 22mm, ID:17mm (No Bearing)
OTWH-27		Skeleton Roller, 76.2mm x 22mm, ID:20mm, bearing 6204
OTWH-28		Iron Roller, for Pulley Block
OTWH-29		Roller, with shaft 70mm x 35mm
OTWH-30		Handrail support roller, 50mm x 55mm, bearing 6203
OTWH-31		Tension Chain Roller, 76mm x 54mm, bearing 6201 Dul, Nylon
OTFP-3	GAA265AT1	Escalator Drive Sheave, Friction Wheel 456/218 X 35mm
OTFP-15	DAA265K11	Friction Wheel



OTWH-2

OTWH-3



OTWH-5

OTWH-5D

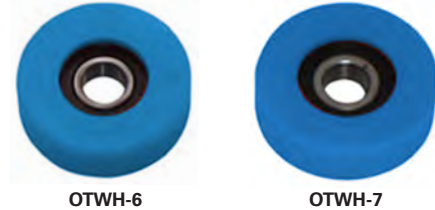

OTWH-6

OTWH-7

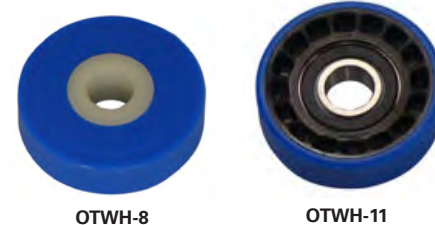

OTWH-8

OTWH-11



OTWH-12

OTWH-13

OTWH-14

OTWH-20

OTWH-21

OTWH-22

OTWH-23

OTWH-24

OTWH-24A

OTWH-25

OTWH-25A

OTWH-29

OTWH-30

OTWH-31

OTFP-3

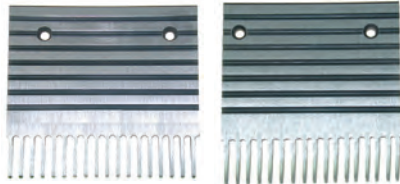
Otis
Comb Plates – Aluminum, Model “J” & “UB”

OE-2

OE-2B



OE-2C

OE-2D

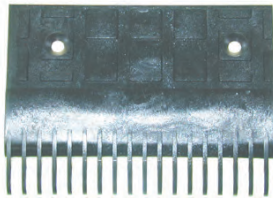

OE-1



OE-1A



OE-1C



OE-1D



OE-1F

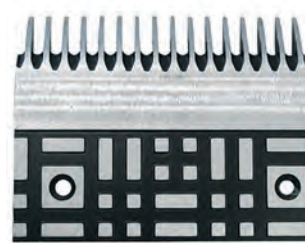

OE-5

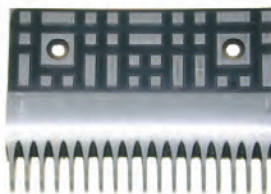

OE-5A

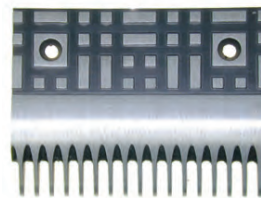

OE-5D

S.E.E.S. #	O.E.M. #	Description	# Teeth
OE-2	G0A453A1	152.355 x 140 x 6.4mm	18
OE-2A	G0A453A4	145.904 x 140 x 6.4mm	17
OE-2B	G0A453A5	136.479 x 140 x 6.4mm, Type 48 “J” and 48 “UB”	16
OE-2C	G0A453A6	142.830 x 140 x 6.4mm, Type 48 “J” and 48 “UB”	17
OE-2D	G0A453A9	126.954 x 140 x 6.4mm, Type 48 “J” and 48 “UB”	15

Comb Plates – Black Lexan, Model “O”

S.E.E.S. #	O.E.M. #	Description	# Teeth
OE-1	A453Z1	5.992" x 4-1/4" x 1/4"	18
OE-1A	A453Z2	5-7/16" x 4-1/4" x 1/4"	16
OE-1B	A453Z3	5.71" x 4-1/4" x 1/4"	17
OE-3	A453Z4	5.738" x 4-1/4" x 1/4"	17
OE-1C	A453Z5	5.367" x 4-1/4" x 1/4"	16
OE-4	A453Z6	5.617" x 4-1/4" x 1/4"	17
OE-1D	A453Z7	5-9/16" x 4-1/4" x 1/4"	16
OE-1E	A453Z8	5-13/16" x 4-1/4" x 1/4"	17
OE-1F	A453Z90	5" x 4-1/4" x 1/4"	15
OE-1G	A453Z10	5-7/8" x 4-1/4" x 1/4"	18
OE-1H	A453Z13	5.863" x 4-1/4" x 1/4"	17

Comb Plates – Aluminum, Model “R”

S.E.E.S. #	O.E.M. #	Description	# Teeth
OE-5A	453Y1	5.99" x 4-1/4" x 1/4"	18
OE-5B	453Y2	5.46" x 4-1/4" x 1/4"	16
OE-5C	453Y3	5.71" x 4-1/4" x 1/4"	17
OE-5D	453Y4	5.738" x 4-1/4" x 1/4"	17
OE-5	453Y5	5.367" x 4-1/4" x 1/4"	16
OE-5E	453Y6	5.617" x 4-1/4" x 1/4"	17
OE-5F	453Y9	4.992" x 4-1/4" x 1/4"	15

OTIS - Comb Plates

S.E.E.S. #	O.E.M. #	Description
OE-2A-Y	G0A453A4	Comb, yellow, 17 teeth
OE-2A-YP	G0A453A4	Comb, yellow/plastic 17 teeth
OE-2B-Y	G0A453A5	Comb, yellow, 16 teeth
OE-2B-YP	G0A453A5	Comb, yellow/plastic, 16 teeth
OE-2C-Y	G0A453A6	Comb, yellow, 17 teeth,
OE-2C-YP	G0A453A6	Comb, yellow/plastic, 17 teeth
OE-2D-Y	G0A453A9	Comb, yellow, 15 teeth
OE-2D-YP	G0A453A9	Comb, yellow/plastic, 15 teeth
OE-2-YP	G0A453A1	Comb, yellow/plastic, 18 teeth
OE-208-Y-R	AAA453AJ26	Comb Plate, Yellow Right
OE-208-Y-L	AAA453AJ23	Comb Plate, Yellow Left
OE-209-G-R	AAA453AJ1	Comb Plate, Green Glow Left
OE-1J-Y	453Z12Y	Comb Plate, 17 Teeth, Yellow
OE-1H-Y	453Z13Y	Comb Plate, 17 Teeth, Yellow
OE-1-Y	453Z1Y	Comb Plate, 18 Teeth, Yellow



OE-2A-Y



OE-2B-Y



OE-2C-Y



OE-2D-Y



OE-208-Y-R



OE-208-Y-L



OE-209-G-R

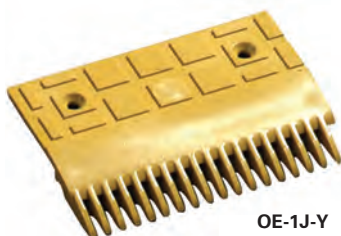

OE-1J-Y



OE-1H-Y



OE-1-Y

OTIS - Comb Plates

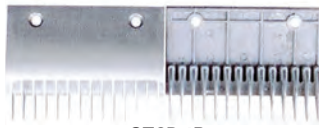

OTCP-1B



OTCP-8



OTCP-8A

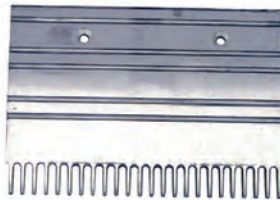

OTCP-9



OE-10-Y



OE-10A-Y



OE-10B-Y

S.E.E.S. #	O.E.M. #	Description
OTCP-1A	XAA453P2	Comb Plate, FT (plastic)
OTCP-1B	XAA453P1	Comb Plate, FT0702-1 Comb (aluminum)
OTCP-2	GOA453A1	Comb Plate, Aluminium 152.2mm x 140.5mm, 18 teeth
OTCP-7		Comb Plate, Aluminium Alloy Comb Plate, 22 teeth
OTCP-8		Comb Plate, Aluminium Alloy Comb Plate, 22 teeth
OTCP-9	G0453D	Comb Plate, Aluminium Alloy Comb Plate, 24 teeth
OTCP-7A	XAA453AB6	Comb Plate, Aluminium 193.2mm x 111.2mm, Pitch = 8.4mm, Install hole = 142.8mm, 23T
OTCP-7B	XAA453AB7	Comb Plate, Aluminium 214.2mm x 111.2mm, Pitch = 8.4mm, Install hole = 142.8mm, 23T
OTCP-7C	XAA453AB8	Comb Plate, Aluminium 214.2mm x 111.2mm, Pitch = 8.4mm, Install hole = 142.8mm, 23T
OTCP-8A	XAA453BC1	Comb Plate, Aluminium 204.3mm x 132.6mm, Pitch = 9.068mm, Install hole = 145mm, 22T
OTCP-8B	XAA453BC2	Comb Plate, Aluminium 199.5mm x 132.6mm, Pitch = 9.068mm, Install hole = 145mm, 22T
OTCP-8C	XAA453BC3	Comb Plate, Aluminium 204.3mm x 132.6mm, Pitch = 9.068mm, Install hole = 145mm, 22T
OE-10-Y	AAA453AJ15	Comb Plate, Center Yellow
OE-10A-Y	AAA453AJ20	Comb Plate, Right Hand Yellow
OE-10B-Y	AAA453AJ19	Comb Plate, Left Hand Yellow
OTCP-10C	XAA453J	Comb Plate, Aluminium Alloy, Length: 193.2mm Height: 145.3mm Hole Spacing: 142.4mm Tooth Pitch: 8.4 Remark: Aluminum, Center
OTCP-10L	XAA453J	Comb Plate, Aluminium Alloy, Length: 214.2mm Height: 145.3mm Hole Spacing: 142.4mm Tooth Pitch: 8.4 Remark:Aluminum, Left
OTCP-10R	XAA453J	Comb Plate, Aluminium Alloy, Length: 214.2mm Height: 145.3mm Hole Spacing: 142.4mm Tooth Pitch: 8.4 Remark: Aluminum, Right
OTCP-11L	XAA453BJ1	Aluminum Alloy Comb Plate, 203.184mm x 132.64mm 8.466 101.7 24T
OTCP-11C	XAA453BJ2	Aluminum Alloy Comb Plate, 197.994mm x 132.64mm 8.466 101.7 23T
OTCP-11R	XAA453BJ3	Aluminum Alloy Comb Plate, 206.39mm x 132.64mm 8.466 101.7 24T
OTCP-12A	GAA453BV1	Comb Plate, Aluminum Esc 24 Tooth, L.H. Travolator
OTCP-12B	GAA453BV5	Comb Plate, Aluminum Esc 24 Tooth, Center
OTCP-12C	GAA453BV6	Comb Plate, Aluminum Esc 23 Tooth, R.H.
OTCP-19	XAA453CD	Comb Plate, Length: 206mm Height: 139.2mm Hole Spacing: 101.6mm Tooth Pitch: 8.4 Remark: Aluminum 24 Teeth, Right

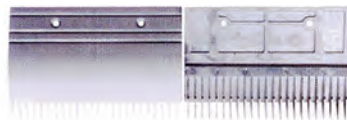

OTCP-11L



OTCP-19

OTIS - Comb Plates

S.E.E.S. #	O.E.M. #	Description
OTCP-20A	GAA453BM1	Comb Plate , Length: 203mm Height: 139.2mm Hole Spacing: 101.7mm Tooth Pitch: 8.4 Remark: Aluminum 24 Teeth, Center
OTCP-20B	GAA453BM7	Comb Plate , Length: 195mm Height: 139.2mm Hole Spacing: 101.7mm Tooth Pitch: .8.4 Remark: Aluminum 23 Teeth, Left
OTCP-20C	GAA453BM5	Comb Plate , Length: 206mm Height: 139.2mm Hole Spacing: 101.6mm Tooth Pitch: 8.4 Remark: Aluminum 24 Teeth, Right
OTCP-20D	GAA453BM6	Comb Plate , Length: 195mm Height: 139.2mm Hole Spacing: 101.7mm Tooth Pitch: .8.4 Remark: Aluminum 23 Teeth, Left
OTCP-20E	GAA453BM3	Comb Plate , Length: 198 Height: 139.2 Hole Spacing: 101.7 Tooth Pitch: 8.4 Remark: Aluminum 24 Teeth Left
OTCP-24R	XAA453AV1 PNS1.18-1/2	Comb Plate , Length: 202.9mm Hole Spacing: 145.3mm Tooth Pitch: 9.068mm Remark: Aluminum 22 Teeth, Right
OTCP-24C	XAA453AV2	Comb Plate , Length: 199.4mm Hole Spacing: 145mm Tooth Pitch: 9.068 Remark: Aluminum 22 Teeth, Center
OTCP-24L	XAA453AV3 PNS1.18-1/3	Comb Plate , Length: 202.9mm Hole Spacing: 145.3mm Tooth Pitch: 9.068mm Remark: Aluminum 22 Teeth, Left
OTCP-25C	L47312023A	Comb Plate , E type comb plate W=199.4
OTCP-25L	L47312024A	Comb Plate , E type comb plate
OTCP-25R	L47312022A	Comb Plate , E type comb plate
OTCP-29C		Comb Plate , Yellow Length: 192.6mm Height: 107.5mm Hole Spacing: 145mm Tooth Pitch: 9.068 Remark: Plastic, Center
OTCP-29L		Comb Plate , Yellow Length: 213mm Height: 107.5mm Hole Spacing: 142.4mm Tooth Pitch: 8.4 Remark: Plastic, Left
OTCP-29R		Comb Plate , Yellow Length: 213mm Height: 107.5mm Hole Spacing: 142.4mm Tooth Pitch: 8.4 Remark: Plastic, Right



OTCP-20D



OTCP-20E

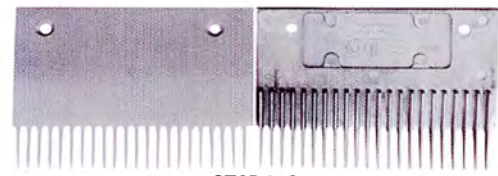

OTCP-24C



OTCP-25C



OTCP-29C



OTCP-29L



OTCP-29R

OTIS - Comb Plates



OE-10

S.E.E.S. #	O.E.M. #	Description
OE-10	G0453D1	Comb, 8" W, 24 teeth, center, Aluminum, 506 series
OE-10A	G0453D6	Comb, 7-3/4" W, 23 teeth, R.H., Aluminum, 506 series
OE-10B	G0453D5	Comb, 8-1/8" W, 24 teeth, L.H., Aluminum, 506 series
OE-10E	G0453D4	Comb, aluminum, 506, 506SL, 510 (before 1991), 7.7" L, 24 Teeth
OE-10C	G0453D2	Comb, aluminum, 506, 506SL 7.7" L, 23-teeth 453D2
OE-10D	G0453D3	Comb, aluminum, 506, 506SL 8.1" L, 23-teeth, w/ demarcations

OTIS - Demarcation Strips

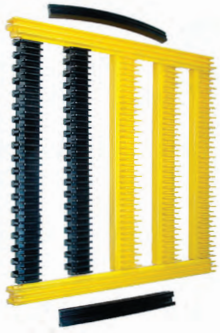

OTYDS-7A
OTYDS-7B
OTYDS-7C
OTYDS-7D
OTYDS-7E

S.E.E.S. #	Description
OTYDS-7A	Demarcation Strip, Length: 277.2mm Tooth Pitch: 8.4mm Width: 32.8mm
OTYDS-7B	Demarcation Strip, Length: 252mm Tooth Pitch: 8.4mm Width: 32.8mm
OTYDS-7C	Demarcation Strip, Length: 319.2mm Tooth Pitch: 8.4mm Width: 32.8mm
OTYDS-7D	Demarcation Strip, Length: 319.2mm Tooth Pitch: 8.4mm Thick Width: 41.5 mm
OTYDS-7E	Demarcation Strip, Length: 267.6mm Tooth Pitch: 22.5mm Thick Width: 24mm
OTYDS-8A	Demarcation Strip, Length: 317mm Tooth Pitch: 9.068mm Width: 41.7mm
OTYDS-8B	Demarcation Strip, Length: 317mm Tooth Pitch: 9.068mm Width: 32.8mm
OTYDS-8C	Demarcation Strip, Length: 211.2mm Tooth Pitch: Width: 19.1mm
OTYDS-8D	Demarcation Strip, Length: 403.5mm Tooth Pitch: 26.8mm Thick Width: 25.5 mm
OTYDS-8E	Demarcation Strip, Length: 397.5mm Tooth Pitch: 26.8mm Thick Width: 25.5mm
OTYDS-9A	Demarcation Strip, Length: 211.2mm Tooth Pitch: 8.466mm Width: 22.6 mm
OTYDS-9B	Demarcation Strip, Length: 211.2mm Tooth Pitch: 8.466mm Width: 17.9mm
OTYDS-9C	Demarcation Strip, Length: 321.6mm Tooth Pitch: 8.466mm Width: 45.5mm
OTYDS-9D	Demarcation Strip, Length: 321.6mm Tooth Pitch: 8.466mm Width: 39.5mm
OTYDS-9E	Demarcation Strip, Length: 411mm Tooth Pitch: 25.5mm Thick Width: 24.5mm
OTYDS-9F	Demarcation Strip, Length: 409mm Tooth Pitch: 25.5mm Thick Width: 24.5mm

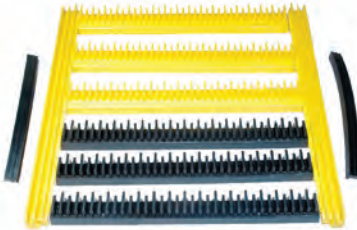

OTYDS-8A
OTYDS-8B
OTYDS-8C
OTYDS-8D
OTYDS-8E

S.E.E.S. #	O.E.M. #	Description
OTYDS-10L	L47332136A	Demarcation Strip, Left
OTYDS-10R	L47332136B	Demarcation Strip, Right
OTYDS-10F	L47332127A	Demarcation Strip, Front Left
OTYDS-10FC	L47332128A	Demarcation Strip, Front Center
OTYDS-10FR	L47332135A	Demarcation Strip, Front Right
OTYDS-10RL	L47332137A	Demarcation Strip, Rear Left
OTYDS-10RC	L47332138A	Demarcation Strip, Rear Center
OTYDS-10RR	L47332139A	Demarcation Strip, Rear Right
OTYDS-14A		Demarcation Strip, Length: 319.2mm Tooth Pitch: 8.4mm Width: 41.5mm
OTYDS-14B		Demarcation Strip, Length: 267.6mm Tooth Pitch: 25.5mm Thick Width: 24mm
OTYDS-15A		Demarcation Strip, Length: 203mm Tooth Pitch: 8.4mm Width: 32mm
OTYDS-15B		Demarcation Strip, Length: 411mm Thick: 17mm Width: 25mm, yellow



OTYDS-9A
OTYDS-9B
OTYDS-9C
OTYDS-9D
OTYDS-9E
OTYDS-9F



OTYDS-10L
OTYDS-10C
OTYDS-10R

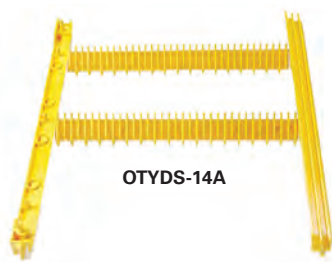

OTYDS-14A



OTYDS-15A
OTYDS-15B

OTIS - Demarcation Strips

S.E.E.S. #	O.E.M. #	Description
OTYDS-17A	H2106212 32188940-M	Demarcation Strip , Length: 319mm Tooth Pitch: 8.4 Width: 42mm, yellow
OTYDS-17B		Demarcation Strip , Length: 319mm Tooth Pitch: 8.4mm Width: 41mm
OTYDS-17C	H2106223 32188939-M	Demarcation Strip , Length: 319mm Tooth Pitch: 8.4 Width: 25.3 mm, yellow
OTYDS-17D		Demarcation Strip , Length: 395mm Tooth Pitch: 12 Thick Width: 24.7mm, yellow
OTYDS-25	XAA26143A530	Demarcation (the Stainless Steel Step)
OTYDS-26A	XAA455Q1	Demarcation 508 (pallet L)
OTYDS-26B	XAA455R1	Demarcation 508 (pallet R)
OTYDS-26C	XAA455K1	Demarcation (pallet behind) Length: 321.6mm Width: 31.4mm Tooth Pitch: 8.4
OTYDS-26D	XAA455J1	Demarcation (pallet front) Length: 321.6mm Width: 55mm Tooth Pitch: 8.4
OTYDS-27A	L47312039A/B	Demarcation Strip , Black Long
OTYDS-27B	L47312038A/B	Demarcation Strip , Black Short
OTYDS-27C	L47312027A	Demarcation Strip , Strip Yellow
OTYDS-27D	L47312028A	Demarcation Strip , Strip Yellow
OTYDS-31L	XAA455L1	Demarcation (pallet L) Length: 403mm Width: 24.2mm Tooth Pitch: 8.4, yellow
OTYDS-32L	LL8 034 024	Demarcation Strip , Yellow Length: 268mm Tooth Pitch: 8.4 Width: 24mm Front Thick: 25mm Left, yellow
OTYDS-32C	HE00528 LL8 034 023	Demarcation Strip , Black Length: 319 Tooth Pitch: 8.4 Width: 42mm Front Thick: 25mm Front, yellow
OTYDS-32R	LL8 034 024	Demarcation Strip , Yellow Length: 268mm Tooth Pitch: 8.4 Width: 24mm Front Thick: 25mm Right, yellow
OTYDS-37	LDTJ-A-14	Demarcation Strip , Length: 395mm Tooth Pitch: 12 Thick Width: 24.7mm Right, yellow



OTYDS-15B



OTYDS-17A



OTYDS-17C



OTYDS-17D



OTYDS-26C



OTYDS-26D



OTYDS-27C



OTYDS-31L



OTYDS-32L



OTYDS-32C



OTYDS-37

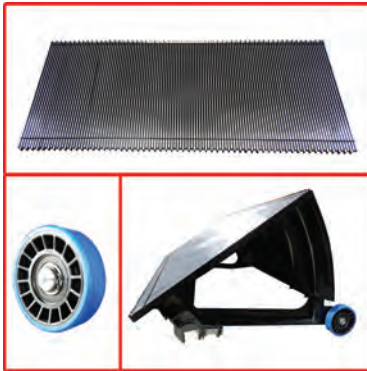

OTST-1



OTST-3

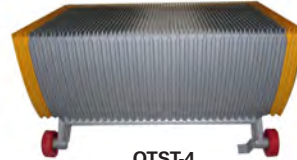

OTST-4



OTST-7



OTST-8



OTST-13



OTST-14



OTST-15



OTST-20

Otis - Steps

S.E.E.S. #	O.E.M. #	Description
OE-001	GAA26140F9	Escalator step assembly, 40/1000mm, black
OTST-1		Step, Otis 1000mm
OTST-3		Step, Stainless Steel (600mm)
OTST-3A		Step, Otis 1000mm With Yellow Demarcation
OTST-4	GAA26340H5	Step, Aluminum With Demarcation Strip, 1000mm
OTST-5	XAA26145A1	Steps, 508 Stainless Steel 1000mm
OTST-6	XAA26145A2	Steps, 508 Stainless Steel 800mm
OTST-7	XAA26340B1	Sidewalk Pallet
OTST-8		Step, Complete
OTST-9	XAA455A28	Step, Aluminum, Black, 1000mm
OTST-10	XAA26340B1/B2	Stainless Steel Pallet
OTST-13	GAA26340H5	Pallet, Otis 606, 1000mm with paint demarcation
OTST-14		Step, OTIS 506, 800mm with paint Demarcation Line
OTST-15	XAA26340B1	Stainless Steel Pallet
OTST-20		Adjusting washer, O.D. = 31.5mm, I.D. = 22mm, Thickness: 0.2mm

OTIS - Bushings

S.E.E.S. #	Description
OTBEA-1	Otis Bushing, XIZI
OTBEA-2	Otis Bushing, XIZ



OTBEA-1



OTBEA-2

OTIS - Belts

S.E.E.S. #	O.E.M. #	Description
OTBE-1		Multi-Wedge Rubber Belt
OTBE-2		Multi-Wedge Rubber Belt
OTBE-5		Handrail Traction Belt
OTBE-6		Drive Belt for Handrail, Otis 506, 2476mm
OE-9	V717AAA1	Handrail Drive Belt



OTBE-5



OTBE-6



OE-9



OE-200



OE-200A

OTIS - Step Treads and Risers

S.E.E.S. #	O.E.M. #	Description
OE-200	455AD1-26BR1	Step Tread, Right Hand Black N
OE-200A	455BA1-26BR1	Step Tread, Left Hand Black NR
OE-200B	455CA1-26BR1	Step Tread, Center Black NR
OE-200C	455BA1-26BR2	Step Tread, Left Hand Gray NR
OE-200D	455R2-26BR1	Step Tread, Left Hand RH Black NR
OE-200E	455R1-26BR1	Step Tread, Black NR
OE-202	454T2-BLEP	Riser, for Step Right Hand Black
OE-203	454R2-BLEP	Riser, Cleated Left Hand



OE-200B



OE-200C



OE-200E



OE-202

OTIS - Lamp Fixtures

S.E.E.S. #	O.E.M. #	Description
OE-20	AAA417CF1	Lamp Fixture, for demarcation light, 24", 120V, 60Hz without lamp or switch



OE-20

OTIS - Switch Boxes

S.E.E.S. #	Description
OTCOP-7	Switch Box
OTCOP-8	Switch Box
OTCOP-9	Switch Box



OTFP-1



OTFP-3



OTFP-4



OTFP-5

OTIS - Hall Switches

S.E.E.S. #	O.E.M. #	Description
OTSW-27-1	GAA177HB1	Hall Switch, RED, PNP, Normal Open, S
OTSW-27-2	GAA177HB2	Hall Switch, YELLOW, PNP, Normal Close, N
OTSW-27-3	GAA177HB3	Hall Switch, Truck NI25U-CK40-AP6X2-H1141
OTSW-27-4	GAA177HB4	Hall Switch, Truck NI25U-CK40-AP6X2-H1141
OTSW-27-5	GAA177HB5	Hall Switch, Truck NI25U-CK40-AP6X2-H1141
OTSW-27-6	GAA177HB6	Hall Switch, Truck NI25U-CK40-AP6X2-H1141
OTSW-28-2	DAA177AX2	Hall Switch, Truck NI25U-CK40-AP6X2-H1141

OTIS - Friction Wheels

S.E.E.S. #	O.E.M. #	Description
OTFP-1	DAA565NNN1	Friction Wheel, O.D. = 456mm
OTFP-3	DAA261NNN1	Friction Wheel, 460mm x 35mm
	DAA265NNN1	
OTFP-4		Friction Wheel, 455mm x 50mm x 30mm
OTFP-5	GAA265AT1	Friction Wheel, OTIS 606, 692mm
OTFP-6	GAA265AP1	Friction Wheel, 392mm x 35mm, I.D. = 316mm, w/ screw
OTFP-7	GAA265NNN-P	Friction Wheel, O.D. = 455mm, I.D. = 220mm, Thickness=35mm
OTFP-8		Friction Wheel, O.D. = 557mm, NO thread in install holes
OTFP-8A		Friction Wheel, O.D. = 557mm, Has thread in install holes
OTFP-15	DAA265K11	Friction Wheel

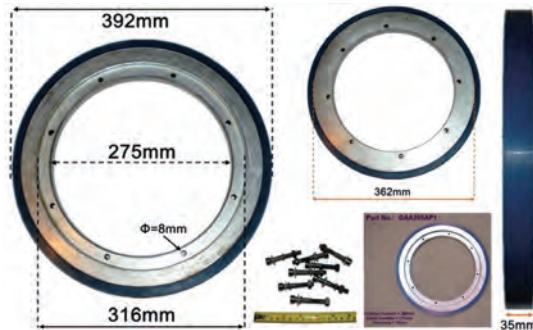

OTFP-6

OTIS - Pallet Parts

S.E.E.S. #	O.E.M. #	Description
OTAX-1	GAA81EH1	Front pallet axle, long
OTAX-2	GAA81EH2	Front pallet axle, short
OTCL-1	GAA94BF1	Front Left Clip
OTCL-2	GAA94BF2	Front Right Clip
OTCL-3	GAA94BF3	Rear Left Clip

OTIS - Guide Rails

S.E.E.S. #	Description
OTGR-1	Guide Rail, OTIS 506 AI
OTGR-2	Guide Rail, OTIS 508 AI

OTIS - Key Switch

S.E.E.S. #	O.E.M. #	Description
OTSW-33	50044082	Key Switch, for OTIS 508 72mm x 32mm x 32mm

OTIS - Step Sensors

S.E.E.S. #	O.E.M. #	Description
OTSW-26	XAA177BE1	Step Sensor, Truck NI25U-CK40-AP6X2-H1141

OTIS - Sprockets

S.E.E.S. #	Description
OTSPK-1	Sprocket, 9-Teeth sprocket with friction teeth, without blue ring
OTSPK-2	Sprocket, 9-Teeth sprocket with friction teeth, with blue ring

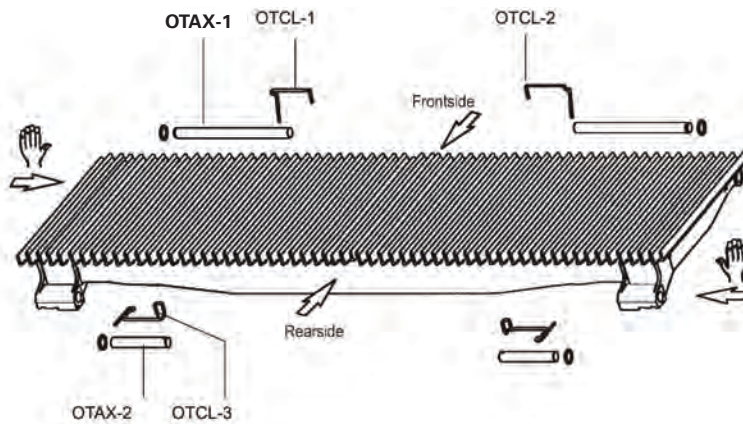

OTSPK-1



OTSPK-2



OTSW-26



OTGR-1



OTGR-2



OE-7



OTHR-1



OTCH-1



OTCH-2



OTCH-3



OTCH-4



OTCH-5



OTCH-6



OTCH-7



OTCH-8



OTCH-10



OE-201

OTIS - Handrail Parts

S.E.E.S. #	O.E.M. #	Description
OE-6	GOA456AY1	Handrail Roller Bearing
OE-7	A6337P1	Handrail Guard Assembly , Includes rubber handrail boots. Hardware: plastic plate, metal plate
OE-14	GAA50AHA1	Handrail J Track
OE-212	G02215AB10	Escalator Handrail Roller , 76mm x 35mm x 12mm Black Delrin, Double 6201
OTHRD-1	GBA26180D1	Handrail Drive
OTHDR-1		Handrail wearing strip , Width=26mm, Thick=6mm

OTIS - Chains

S.E.E.S. #	O.E.M. #	Description
OTCH-1		Reversing Chain Pitch Line: 60/45mm, Width: 33.6mm Twin fork
OTCH-2		Driving Chain Pitch Line: 70mm, O.D. of Roller: 60mm diameter, Width: 55mm, Link Width 35mm, Thickness: 3mm
OTCH-3		Chain for OTIS 506, Pitch Line: 135.6mm O.D. of Roller: 76.2mm diameter
OTCH-3A		Chain for OTIS 506, Pitch Line: 135.47mm O.D. of Roller: 76.2mm diameter
OTCH-4		Chain , XIZI OTIS Chain, Pitch Line: 135.47mm O.D. of Roller: 76.2mm diameter
OTCH-5		Chain , XIZI OTIS Chain, Roller Pitch Line: 131.33mm OD of Roller: 80mm diameter
OTCH-6		Chain , Heavy type T131
OTCH-7		XIZI OTIS Chain Tension And Protection
OTCH-8		XIZI OTIS Chain Tension And Protection
OTCH-10	GAA332Z4	Driving Chain
OE-201	YYJ0332J4	Chain Assembly
OE-204	A59P2	Bolt
OE-210	GX237AW1	Guide Shoe , Nylon for Brake AC Dev 6.75" L Models J, UBSL
OE-211	198AD2	Pully , Guide for Handrail Models R, RB, RBC

OTIS - Misc. Parts

S.E.E.S. #	O.E.M. #	Description
OE-6A	G0221594	Roller Bearing & Roll Pin , Handrail roller and pin kit
OE-6A-1	G0456BA1	Roll pin sleeve
OE-8	G0678A42	Roller Bearing , Handrail Roller
OE-8A	207BN1, 2700AEJ1	Roller Bearing & Pin , Handrail roller and pin kit
OE-8A-1	6800HL1	Knurled steel pin
OE-11		Sensor , Otis Motion Handrail Used On One Step Style Escalator
OE-12		Roller , Newel Otis 508NCE
OE-13	DAA402CR3	Handrail Bearing Assembly ,
OW-6		Spacer for Escalator Roller, 11/16" I.D., 1-5/8" O.D.
OW-14	VP878095	Escalator Step Removing Tool (Two required for safe step removal)
OTGP-1		Guide Piece
OTGP-2	XAA385DI	Guide Piece Small
OTIC-1		Inlet Cover Holder
OTIC-1R	GAB438BNX	Inlet Cover
OTIC-1L	GAB438BNX	Inlet Cover
OTIC-3		Otis Rubber Inlet
OTBRA-2	XAA232W3	Resistor for Brake 1000W, 100
OTBRA-4	TAB330AJ1	Coil , Brake
OTBRA-6		Brake Magnet
OTGS-10	XAA385X	Return Guide , for Escalator 170mm x 57mm Hole Distance: 150mm
OTGS-11		Otis Shoe Guide
OTGS-29	XAA835AJ1	Escalator Slider , 20mm x 58mm x 27mm Hole Distance: 56mm
OTBRA-5	G0222P1	Break
OTLO-14		Escalator Lock
OTLO-2K		Key , Triangle



OE-6A



OE-8A

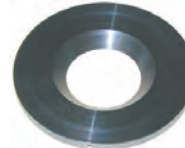

OW-6



OW-14



OTGP-1



OTGP-2



OTIC-3



OTBRA-4



OTIC-1R



OTIC-1L



OTGS-29



OTGS-10



OTGS-11

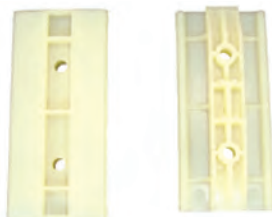

OTGS-29



OTBRA-5



OTLO-14



OTLO-14

LG
LG - Comb Plates

S.E.E.S. #	O.E.M. #	Description
LCP-3L	2L05755	Comb Plate , 160mm x 90mm, 17 teeth
LCP-3M	2L05753	Comb Plate , 160mm x 90mm, 16 teeth
LCP-3R	2L05754	Comb Plate , 160mm x 90mm, 17 teeth
LCP-4C	DSA2000168-M	Comb Plate , Yellow, Length: 142.2mm, Height: 94.5mm, Hole Spacing: 90mm, Tooth Pitch: 8mm, Remark: Plastic 17 Teeth, Center
LCP-4L	DSA2000168-L	Comb Plate , Yellow, Length: 146.4mm, Height: 94.5mm, Hole Spacing: 90mm, Tooth Pitch: 8mm, Remark: Plastic 17 Teeth Right
LCP-4R	DSA2000168-R	Comb Plate , Yellow, Length: 146.4mm, Height: 94.5mm, Hole Spacing: 90mm, Tooth Pitch: 8mm, Remark: Plastic 17 Teeth Left
LCP-6		Sigma Comb Plate , Length: 206mm, Hole Spacing: 110mm, Tooth Pitch: 8.4mm, Remark: Aluminum, 24 Teeth Left
LCP-7		Sigma Comb Plate , Length: 203mm, Hole Spacing: 110mm, Tooth Pitch: 8.4mm, Remark: Aluminum, 24 Teeth Center
LCP-8		Comb Plate , Length: 206mm, Hole Spacing: 110mm, Tooth Pitch: 8.4mm, Remark: Aluminum, 24 Teeth
LCP-9		Comb Plate , Length: 197.5mm, Hole Spacing: 110mm, Tooth Pitch: 8.4mm, Remark: Aluminum, 23 Teeth
LCP-10		Comb Plate , Length: 205mm, Hole Spacing: 110mm, Tooth Pitch: 8.4mm, Remark: Aluminum, 24 Teeth
LCP-11		Comb Plate , Length: 199mm, Hole Spacing: 110mm, Tooth Pitch: 8.4mm, Remark: Aluminum, 23 Teeth
LCP-12CL		Comb Plate , Yellow, Length: 109.4mm, Height: 90mm, Hole Spacing: 60mm, Tooth Pitch: 9mm, Remark: Plastic, 12 Teeth Center, Short
LCP-12CS		Comb Plate , Yellow, Length: 145.40mm, Height: 90mm, Hole Spacing: 90mm, Tooth Pitch: 9mm, Remark: Plastic, 16 Teeth, Center, Long
LCP-12L		Comb Plate , Yellow, Length: 160mm, Height: 90mm, Hole Spacing: 90mm, Tooth Pitch: 9mm, Remark: Plastic, 17 Teeth, Left
LCP-12R		Comb Plate , Yellow, Length: 160mm, Height: 90mm, Hole Spacing: 90mm, Tooth Pitch: 9mm, Remark: Plastic, 17 Teeth, Right
LCP-13R	2L08298R	AI Escalator Comb Plate
LCP-13M	2L08298M	AI Escalator Comb Plate
LCP-13L	2L08298L	AI Escalator Comb Plate
LCP-14C	DSA2001489-M	Comb Plate , 202.6mm x 94.4mm, 22T, ABS, Yellow, Center
LCP-14L	DSA2001488A-L	Comb Plate , 202.6mm x 94.4mm, 22T, ABS, Yellow, Left
LCP-14R	DSA2001488B-R	Comb Plate , 202.6mm x 94.4mm, 22T, ABS, Yellow, Right

*measurements in millimeters



LCP-4C

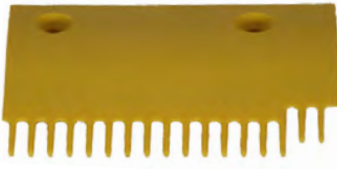

LCP-4L

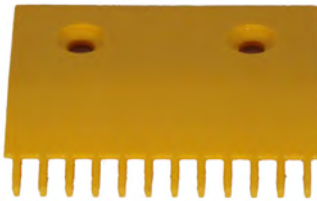

LCP-12CL

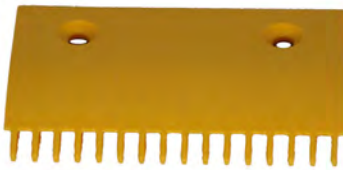

LCP-12CS

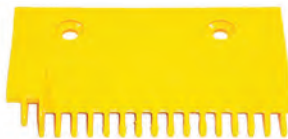

LCP-13R



LCP-14C



LCP-14L



LCP-14R

LG - Demarcation Strips

S.E.E.S. #	O.E.M. #	Description
LYDS-1B	H2106233	Demarcation Strip, black, rear
LYDS-1F	H2106211	Demarcation Strip, black, front
LYDS-2L	1L05214-L	Demarcation Strip, yellow, left
LYDS-2R	L05214-R	Demarcation Strip, yellow, right
LYDS-3B	2L05914-M	Demarcation Strip, yellow, rear
LYDS-3F	2L05913-M	Demarcation Strip, yellow, front
LYDS-4C	2L09005-MS	Demarcation Strip, yellow, mid
LYDS-5L	DSA3000583A	Demarcation Strip, yellow, left
LYDS-5R	DSA3000583B	Demarcation Strip, yellow, right
LYDS-05A	L48034005A	Demarcation Strip
LYDS-6	2L05914-M	Demarcation Strip, 22T, ABS, yellow
LYDS-6L	DSA2001530	Demarcation Strip, left
LYDS-6R	DSA2001530	Demarcation Strip, right
LYDS-7	DSA2001531	Demarcation Strip, 20T, ABS, yellow
LYDS-8	DSA2001533	Demarcation Strip, Center
LYDS-20A	L48034020A	Demarcation Strip



LYDS-2L



LYDS-2R



LYDS-3B



LYDS-3F



LYDS-05A



LYDS-6



LYDS-7



LYDS-8



LYDS-20A

LG - Steps

S.E.E.S. #	Description
LST-1	Aluminum Step
LST-2	Step, Stainless
LST-5	LG Step, DSA1005170



LST-1

LG - Friction Pulleys

S.E.E.S. #	Description
LFP-1	Friction Pulley, 692mm x 35mm ID: 45mm Keyway: 10
LFP-2	Friction Pulley, 610mm x 35mm ID: 45mm Keyway: 10
LFP-3	Friction Pulley, OD: 458mm x 35mm ID: 45mm



LFP-1



LFP-2



LFP-3

LG - Rollers

S.E.E.S. #	O.E.M. #	Description
LGR-1	LG-3L10592A	Guide Rail Reversing Section 14 Rollers
LWH-3		Roller, 80mm x 22mm ID: 20mm, bearing 6204
LWH-4		Roller, LG-SIGMA escalator Press Roller 90mm x 64mm x 60mm-6202 (DBL)
LWH-5		Roller, LG 14 Wheel Gate Roller Assembly
LWH-6	3L10902A 4L08177B	Roller, LG Idle Tension Roller with Shaft 70mm x 60mm x 15mm-6202 (DBL)



LWH-3



LWH-4



LWH-6

THYSSENKRUPP

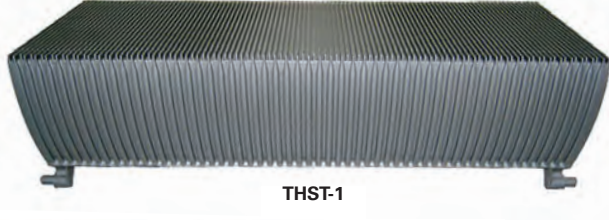

THYSSENKRUPP - Steps

S.E.E.S. #	Description
THST-1	Step, Aluminum
THST-2	Step, Stainless Steel
THST-3	Sidewalk Pallet

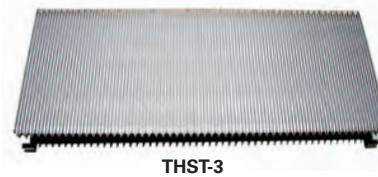

Inlet Covers

S.E.E.S. #	Description
THIC-1	Inlet Cover, with holes
THIC-2	Inlet Cover, without holes



THYSSENKRUPP - Chains

S.E.E.S. #	Description
THCH-2	Reversing Chain, 24-roller
THCH-3	Step Chain, 14.63mm diameter

THYSSENKRUPP - Demarcation Strips

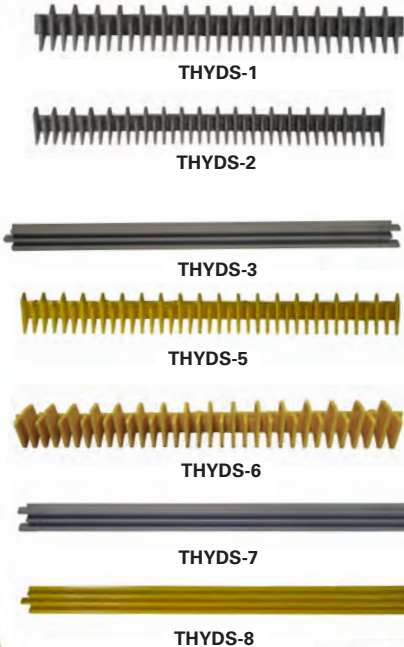

S.E.E.S. #	O.E.M. #	Description
THYDS-1		Demarcation Strip, Length: 284mm, Tooth Pitch: 8.5 Width: 33.3mm
THYDS-2		Demarcation Strip, Length: 327.8mm, Tooth Pitch: 8.5, Width: 33.3mm
THYDS-3		Demarcation Strip, Length: 410.2mm, Tooth Pitch: 14.2, Thick Width: 26mm
THYDS-4		Demarcation Strip, Escalator Yellow, L: 284.5mm, W: 33.3mm
THYDS-5		Demarcation Strip, Length: 327.8mm, Tooth Pitch: 8.5, Width: 33.3mm, Thick: 14.2mm
THYDS-6		Demarcation Strip, Length: 410.2mm, Tooth Pitch: 8.5, Width: 26mm, Thick: 14.2mm, Left
THYDS-7		Demarcation Strip, Length: 410.2mm, Tooth Pitch: 14.2, Thick Width: 26mm, Right
THYDS-8		Demarcation Strip, Length: 410.2mm, Tooth Pitch: 8.5, Width: 26mm, Thick: 14.2mm, Right
THYDS-53B	L47332153B	Demarcation Strip, 15 Teeth
THYDS-54A	L47332154A	Demarcation Strip
THYDS-55A	L47332155A	Demarcation Strip



THYSSENKRUPP

THYSSENKRUPP - Rollers

S.E.E.S. #	Description
THWH-1	Roller, 88mm x 30mm, 6204, ID: 20mm
THWH-2	Multi-Wedge Belt Sheave, 111mm x 60mm, 6204 Double Bearing, ID: 20mm
THWH-3	Multi-Wedge Belt Sheave, 111mm x 60mm, 6304 Double Bearing, ID: 20mm
THWH-4	Roller, 80mm x 60mm, 6204, ID: 20mm
THWH-5	Roller, 75mm x 23mm, 6204, ID: 20mm
TGRT-001	Target, Guide Rail
THWH-6	Groove Roller, 100mm x 32mm, 6204, GD: 86mm, ID: 20mm



THWH-1



THWH-2



THWH-3



THWH-4



THWH-5



THWH-6

THYSSENKRUPP - Comb Plates

S.E.E.S. #	Description
THCP-1	Comb Plate for Escalator Length: 204mm, Height: 115.8mm, Hole Spacing: 66mm, Tooth Pitch: 8.4mm, Remark: Aluminum 3 Holes 24 Short Teeth
THCP-2	Comb Plate for sidewalk Length: 204mm, Height: 127.8mm, Hole Spacing: 66mm, Tooth Pitch: 8.4mm, Remark: Aluminum 3 Holes 24 Long Teeth
THCP-3	Comb Plate, 205 * 116mm



THCP-1



THCP-2



THCP-3

THYSSENKRUPP - Misc. Parts

S.E.E.S. #	Description
THY-FELT-001	Felt Pad, 0.12" TH x 1.75" L x 2.875" W
THCH-2	Reversing Chain, 24-roller
TBLT-001	Belt, Poly, V72544
THLO-2	Power Lock, with Stop Button
THBEA-3	Hollow Shaft Cap
THCH-1	Tension Station Support
THGS-2	Slider
THLI-1	Lighting Curtain
THLI-2	Lamp Clip



THY-FELT-001



TBLT-001



THLO-2



THBEA-3



THCH-1



THGS-2



THLI-1



THLI-2

SCHINDLER / WESTINGHOUSE

Rollers & Wheels

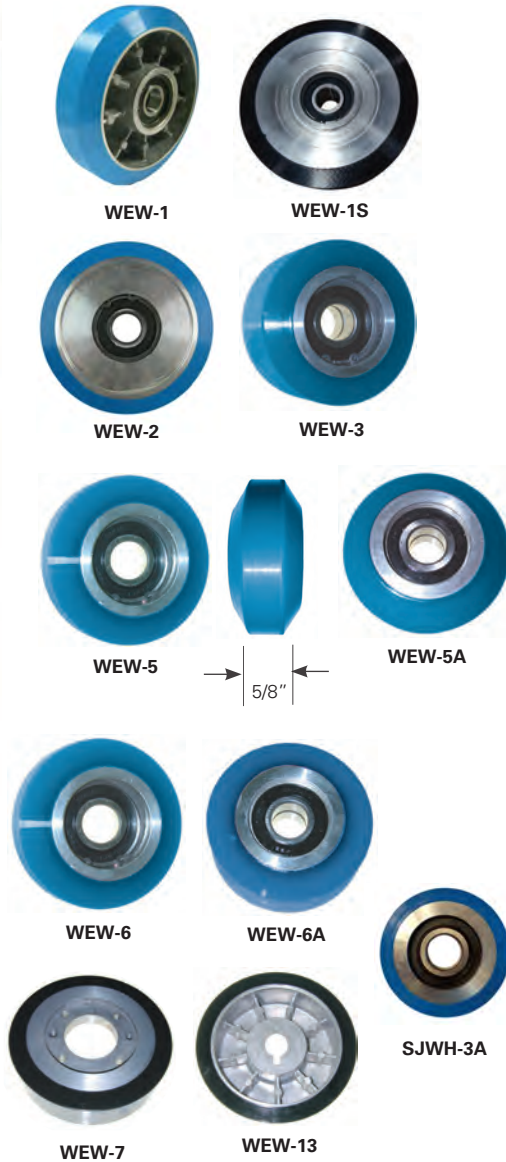

S.E.E.S. #	O.E.M. #	Description
WEW-1	217B235H07	Step chain roller with double bearing for types S, L, M, N & NT. Trail roller for Type S, .6693" I.D., 5-1/4" O.D., 1-3/16" wide, 7/8" tire face.
WEW-1A	322C363G01	Escalator Wheel , with single bearing for Type L & M, .6693" I.D., 5-1/4" O. D., 1-3/16" wide, 7/8" tire face
WEW-1S		Escalator roller , 5-1/4" x 1-3/16" W 7/8" Face, Soft poly
WEW-2	216B509G04	Escalator roller , 4" diameter, with 3/4" tire face, .6693" I.D. bearing
WEW-3	691B759G02	Handrail pressure roller , 3" dia. x 1-5/8" wide, tire face 1-3/32", bearing .6693" I.D.
WEW-5	691B785G05, 691B785G07	Escalator trail roller , for type BB&BT. 3" diameter x 1-1/4", single bearing, .6693" I.D.
WEW-5A	691B785G06, 691B785G08	Escalator trail roller , 3" diameter x 1-1/4", same as above but with double bearing
WEW-6	691B785G01, 691B785G03	Step guide roller for Type BB&BT 3" dia. x 1-1/4", single bearing, .6693" I.D.
WEW-6A	691B785G02, 691B785G04	Step guide roller , 3" diameter x 1-1/4" same as above but double bearing
WEW-7	152B238G01, 152B238G02	Handrail drive roller , Type N & NT. 5.312" diameter x 1.375" wide
WEW-13	196C271G01	Handrail drive roller , 5-11/64" dia., 3/4" I.D.
SJWH-3A	SSEF50110	Roller , 70mm x 25mm, 6204 bearing, poly, with aluminum hub, for SJEC Escalator
SEW-006		Roller Chain Assembly , Newel SWE/ SWU Style 2 Req 17 rollers
SEW-007		Stub Assembly , Newel Handrail Guide SWE Style 11 Req Per Newel
SEC-020	SLH243447	Escalator roller
SEW-001	SMS405029	Step Roller
SEW-003	SMH405045	Handrail newel roller for Escalator
SEW-004	SDS242073 & 27	Escalator Step Roller
SEW-005	241534	Roller , Step roller

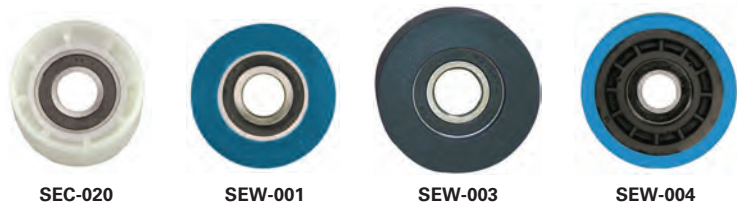

Rollers & Wheels

S.E.E.S. #	O.E.M. #	Description
SCHR-5		Handrail Support Roller
SCHR-6		Handrail Support Roller Assembly
SCWH-2		Roller, 70mm x 25mm, 6204 ID: 20mm
SCWH-4		Skeleton Roller, 76.2mm diameter x 22mm, ID:17
SCWH-5		Roller, Nylon Aluminum Hub Handrail Roller 70mm x 50mm, 6204DU ID: 20mm
SCWH-6		Support Roller, Aluminum Hub, 70mm diameter x 50mm, 6302 ID:15
SCWH-7		Multi-Wedge Belt Sheave, 97mm x 70mm GD: 86 Double Bearing 6204, ID: 20mm
SCWH-8		Multi-Wedge Belt Sheave, 89.5mm x 70mm Double Bearing 6204, GD: 85.4 ID: 20
SCWH-9		Multi-Wedge Belt Sheave, 85m x 70mm, Double Bearing 6204, ID: 20mm
SCWH-11	SSEF50110	Roller, 70mm x 25mm, 6204 ID: 20mm
SCWH-12		Blue Step Roller, 76mm diameter x 25mm
SCWH-13	SSEF50110	Roller, 70mm x 25mm, 6204 ID: 20mm
SCWH-14		Wheel, Central, ID: 35mm
SCWH-18		Roller, 70mm x 70mm
SCWH-19		Guide Roller
SCWH-20		Skeleton Roller, 76mm diameter x 25mm, 6204
SCWH-20B		Anti-Static Roller, 98mm x 30mm



SCHR-5



SCHR-6

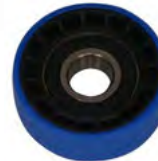

SCWH-2



SCWH-5



SCWH-6



SCWH-7



SCWH-8



SCWH-9



SCWH-11

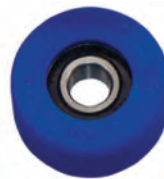

SCWH-12



SCWH-13



SCWH-14

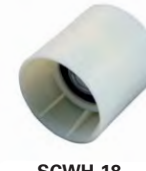

SCWH-18



SCWH-19



SCWH-20



SCWH-20B

SCHINDLER / WESTINGHOUSE - Wheels & Rollers

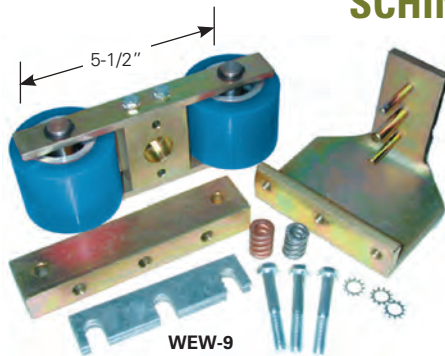

WEW-9

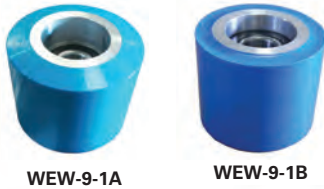

WEW-9-1A

WEW-9-1B

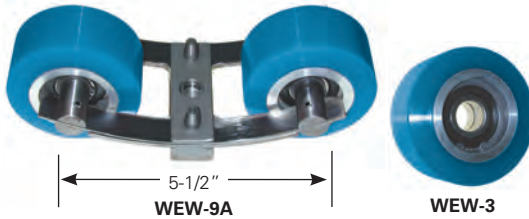

WEW-9A

WEW-3

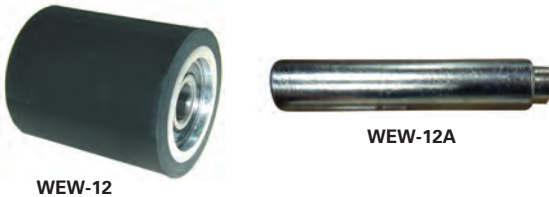

WEW-12

WEW-12A

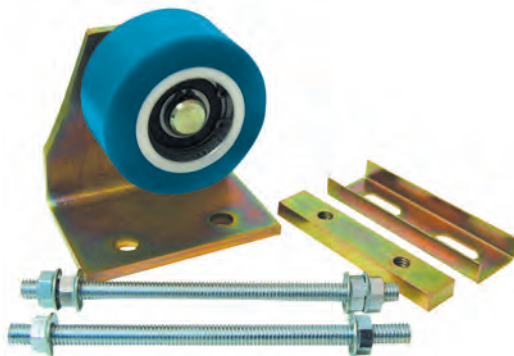

WEW-16

S.E.E.S. #	O.E.M. #	Description
WEW-9	5199D27G01	Pressure roller assembly coil spring type, c/c 5-1/2" shaft to shaft
WEW-10	5199D28G01	Pressure roller assembly coil spring type, c/c 6-1/2" shaft to shaft
WEW-9-1A		Replacement roller , 3" O.D. x 2-1/2" W .6203" bearing tire face for above assemblies WEW-9 and WEW-10
WEW-9-1B		Escalator roller , 3" O.D. x 2-1/2" W with (2) face for 5204 bearing (.7874" I.D.)

■ Old style pressure roller assembly

S.E.E.S. #	O.E.M. #	Description
WEW-9A	5193D59G02	Pressure roller assembly , leaf spring type, c/c 5-1/2" shaft to shaft
WEW-10A	5193D59G01	Pressure roller assembly , leaf spring type, c/c 6-1/2" shaft to shaft
WEW-3	691B759G02	Replacement roller for above assemblies WEW-9A & WEW-10A, 6203 bearing, 3" O.D., 1-5/8" Face

■ New style pressure roller assembly

S.E.E.S. #	O.E.M. #	Description
WEW-12	325C359G01	Pressure roller , 2-1/2" x 3" L, .6693" I.D.
WEW-12A		Axle for above roller
WEW-12B	325C359G01	Handrail Roller and bracket assembly
WEW-15	196C272G01	Take up roller , steel roller, 4.25" x 1.25", double bearings .6693" I.D.
WE-45	5193D53G03	Roller bracket assembly 7" x 3" x 3/8" thick, with tension adjustment bracket on back
WEW-16	197C527G03	Handrail roller , bracket assembly, R.H.
WEW-16A-NT		Roller , roller only, no tire, for WEW-16
WEW-18	MSC1197G04	Handrail pressure roller , 6" O.D., fiber
WEW-19	1724C20G01	Escalator Roller , newell, end



WEW-18

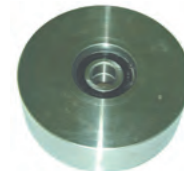

WEW-15



WE-45

SCHINDLER / WESTINGHOUSE - Comb Plates

S.E.E.S. #	O.E.M. #	Description
SCCP-1	SMR313609	Sliding Piece
SCCP-2		Sliding Piece
SCCP-1C		Stopper
SCCP-1YC	SMR313283	Comb Plate , 9300, Length:199.4mm, Height:107mm, Hole Spacing: 145mm, Tooth Pitch: 9.068, Remark: Yellow, 22 Teeth, Center
SCCP-1YL	SMR57410420Y	Comb Plate , 9300, Length: 203mm, Height: 107mm, Hole Spacing: 145mm, Tooth Pitch: 9.068, Remark: Yellow, 22 Teeth, Left
SCCP-1YR	SMR57410421Y	Comb Plate , 9300, Length: 203mm, Height: 107mm, Hole Spacing: 145mm, Tooth Pitch: 9.068, Remark: Yellow, 22 Teeth, Right
SCCP-1BC	SMR313762	Comb Plate , 9300, Length: 199.4mm, Height: 107mm, Hole Spacing: 145, Tooth Pitch: 9.068, Remark: Black, 22 Teeth, Center
SCCP-1BL	SMR57410420H	Comb Plate , 9300, Length: 203mm, Height: 107mm, Hole Spacing: 145mm, Tooth Pitch: 9.068, Remark: Black, 22 Teeth, Left
SCCP-1BR	SMR57410421H	Comb Plate , 9300, Length: 203mm, Height: 107mm, Hole Spacing: 145mm, Tooth Pitch: 9.068, Remark: Black, 22 Teeth, Right
SCCP-1L	SMR313609	Comb Plate , 9301 Length: 203mm, Height: 10mm, 7 Hole Spacing: 145mm, Tooth Pitch: 9.068, Remark: Aluminum, 22 Teeth, Left
SCCP-1R	SMR313609	Comb Plate , 9302 Length: 203mm, Height: 107mm, Hole Spacing: 145mm, Tooth Pitch: 9.068, Remark: Aluminum, 22 Teeth, Right
SCCP-3		Comb Plate , Length: 205mm, Height: 153mm, Hole Spacing: 145mm Tooth Pitch: 9, Remark: Sidewalk Aluminum, 22 Teeth, Center
SCCP-6A1		Comb Plate , Length: 205.5mm, Hole Spacing: 145, Tooth Pitch: 9.068, Aluminum, 22 Teeth
SCCP-6A2		Comb Plate , Length: 205.5mm, Hole Spacing: 145mm, Tooth Pitch: 9.068, Aluminum, 22 Teeth
SCCP-6Y1		Comb Plate , Length: 205.5mm, Hole Spacing: 145mm, Tooth Pitch: 9.068, Yellow, 22 Teeth
SCCP-6Y2		Comb Plate , Length: 205.5mm, Hole Spacing: 145mm, Tooth Pitch: 9.068, Yellow, 22 Teeth
SCCP-6B1		Comb Plate , Length: 205.5mm, Hole Spacing: 145mm, Tooth Pitch: 9.068, Black, 22 Teeth
SCCP-6B2		Comb Plate , Length: 205.5mm, Hole Spacing: 145mm, Tooth Pitch: 9.068, Black, 22 Teeth
SCCP-11C	513208	Comb Plate , Yellow, Length: 205.2mm, Height: 107.8mm, Hole Spacing: 145mm, Tooth Pitch: 9.068, Remark: Plastic, Center
SCCP-11S	513207	Comb Plate , Yellow Length: 199.4mm Height: 107.8mm Hole Spacing: 145mm Tooth Pitch: 9.068 Remark: Plastic Side
SCCP-13L	BEVG	Comb plate , Left
SCCP-13R	BEVG	Comb plate , Right
SCCP-7		Comb Plate , Length: 199mm, Height: 153mm, Hole Spacing: 145mm Tooth Pitch: 9, Remark: Sidewalk Aluminum, 22 Teeth, Side



SCCP-1C



SCCP-1YC



SCCP-1BC



SCCP-3



SCCP-7



SCCP-11C



SCCP-13L



SCCP-13R

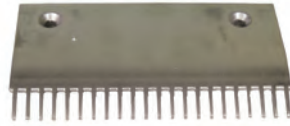

SEC-001



SEC-001B



SEC-002



SEC-002Y



WE-9



WE-10

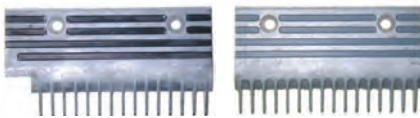

WE-11A

WE-11B



WE-11C



WE-11C-Y



WE-11-Y

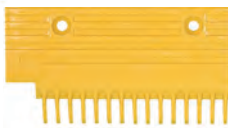

WE-11A-Y



WE-11C-Y



WE-11D-Y

SCHINDLER / WESTINGHOUSE - Comb Plates

S.E.E.S. #	O.E.M. #	Description
SEC-001	SMR898462	Comb plate, Aluminum
SEC-001B	SMR898462	Comb plate, Finger Center, Black Powder Coat
SEC-001Y	SMR898632	Comb plate, Aluminum, yellow
SEC-002	SMR898515	Comb end, Left
SEC-002B	SMR898515	Comb Plate, Left Hand, Black Powder Coat
SEC-002Y	SMR898743	Comb end, Left, yellow
SEC-003	SMR898516	Comb end, Right
SEC-003B	SMR898516	Comb Plate, Right Hand, Black Powder Coat
SEC-003Y	SMR898744	Comb end, Right, yellow
SEC-009	A305005C	Comb, for Schindler, moving walkway, center, yellow
SEC-010	A305005R	Comb, for Schindler, moving walkway, right, yellow
SEC-011	A305005L	Comb, for Schindler, moving walkway, left, yellow



SEC-003



SEC-003Y



SEC-002B

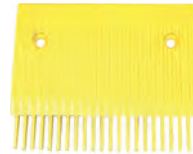

SEC-009



SEC-010

S.E.E.S. #	O.E.M. #	Description
WE-9	X5BFS1H06	Screw for comb plates
WE-10	R9502H04	Aluminum comb plate, 34 teeth, 12", L.H.
WE-10A	R9502H03	Aluminum comb plate, 35 teeth, 12", R.H.

S.E.E.S. #	O.E.M. #	Description
WE-11	626D315H04	Escalator comb plate, 6-1/4", L.H. for 48N, 15 teeth
WE-11A	626D315H05	Escalator comb plate, 6-1/4", R.H. for 48N, 15 teeth
WE-11B	626D315H06	Escalator comb plate, 5-3/4", Center for 32BT & 48BB, 16 teeth
WE-11C	626D315H02	Escalator comb plate, 6-1/4", L.H., 16 teeth
WE-11D	626D315H03	Escalator comb plate, 6-1/4", R.H., 16 teeth

S.E.E.S. #	O.E.M. #	Description
WE-11-Y		Comb plate, yellow, 6-1/4", L.H. for 48N, 15 teeth
WE-11A-Y		Comb plate, yellow, 6-1/4", R.H. for 48N, 15 teeth
WE-11B-Y	626D315H19	Comb plate, yellow, 5-3/4", Center for 32BT & 48BB, 16 teeth
WE-11C-Y		Comb plate, yellow, 6-1/4", L.H., 16 teeth
WE-11D-Y		Comb plate, yellow, 6-1/4", R.H., 16 teeth

S.E.E.S. #	O.E.M. #	Description
WE-11-Y	9905023Y	Comb, yellow plastic, 6-1/4", 15 teeth, L.H.
WE-11A-Y	9905025Y	Comb, yellow plastic, 6-1/4", 15 teeth, R.H.
WE-11B-Y	626D315H06YP	Comb, yellow plastic, 5-3/4", 16 teeth, center
WE-11C-Y	9905027Y	Comb, yellow plastic, 6-1/4", 16 teeth, L.H.
WE-11D-Y	9905028Y	Comb, yellow plastic, 6-1/4", 16 teeth, R.H.

SCHINDLER / WESTINGHOUSE - Demarcation Strips

S.E.E.S. #	O.E.M. #	Description
SCYDS-1A		Demarcation Strip , Length: 319mm, Tooth Pitch: 8.4mm, Width: 42mm
SCYDS-1B		Demarcation Strip , Length: 319mm, Tooth Pitch: 8.4, Width: 42mm
SCYDS-1C		Demarcation Strip , Length: 268mm, Tooth Pitch: 26 Thick Width: 24.4mm
SCYDS-2A	SCS319900	Demarcation strip , Length: 202.5mm, Tooth Pitch: 9.068, Width: 49.6mm (Front)
SCYDS-2B	SCS319905	Demarcation strip , Length: 222mm, Thick: 28mm Width: 28.5mm (Right Radian)
SCYDS-2C	SCS319901	Demarcation strip , Length: 403mm, Thick: 25mm Width: 109mm (Left)
SCYDS-2D	SCS319902	Demarcation strip , Length: 403mm, Tooth Pitch: 25, Thick Width: 96mm (Right)
SCYDS-2E	SCS319903	Demarcation strip , Length: 222mm, Thick: 28mm Width: 28.5mm (Left Radian)
SCYDS-3L	BEVG	Demarcation Strip , Left
SCYDS-3R	BEVG	Demarcation Strip , Right
SEC-005	SCS319901	Step K-edge , LHS
SEC-007	SCS 319902	Step K-edge , RHS
WE-12	321C596H11	Demarcation strip , R.H.
WE-12A	321C596H11	Demarcation strip , R.H. #321C59 6H11/ Bright Yellow
WE-13	321C596H12	Demarcation strip , L.H.
WE-13A	321C596H12	Demarcation strip , L.H. #321C59 6H11/ Bright Yellow
WE-14	321C596H13	Demarcation strip , Center 5-3/4" Long, 23-1/2 Teeth
WE-15	321C596H14	Demarcation strip , Center 5-3/8" Long, 24 Teeth
WE-15S	144A542H03	Screw for Demarcation strip
WE-101	6999C71H01	Demarcation step edge , yellow plastic

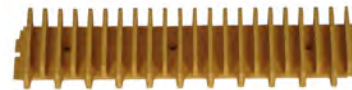

SCYDS-2A



SCYDS-2B



SCYDS-2C



SCYDS-3L



SCYDS-3R



SEC-005



SEC-007



SCYDS-1A SCYDS-1B SCYDS-1C



WE-12



WE-101



SEC-018

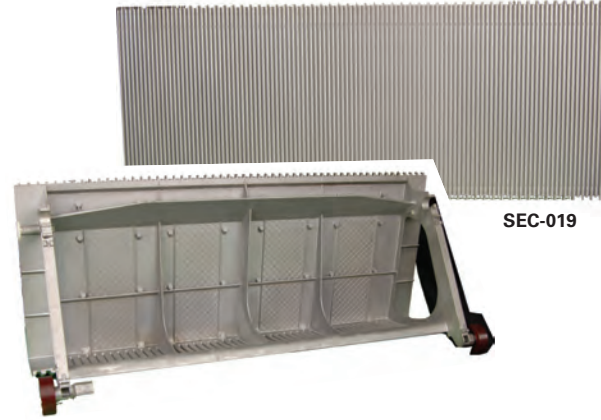

SEC-019

SCHINDLER / WESTINGHOUSE - Steps & Pallets



SCST-1



SCST-2

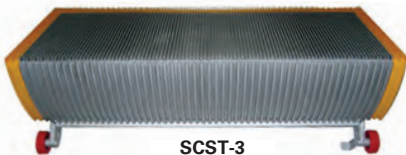

SCST-3



SCST-5



SCST-6

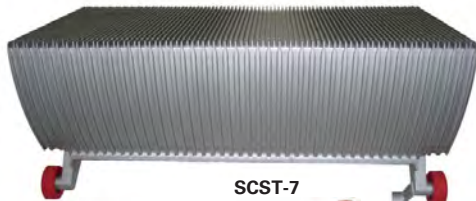

SCST-7



WE-41T



SEC-017



WE-43



WE-44

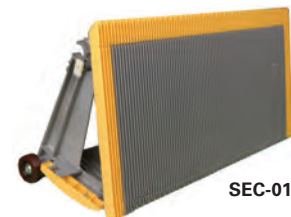

SEC-016

 SCST-1A
SCST-1C

 SCST-1B
SCST-1D

S.E.E.S. #	O.E.M. #	Description
SEC-019	S-SCS468546	Step, 1000mm silver step no demarcation strips
SCST-1		Pallet, Moving Walkway, 1138mm x 140mm
SCST-2		Step, 800mm, aluminum
SCST-3		Escalator with Demarcation, 1000mm
SCST-5		Step, Aluminum, 1000mm
SCST-9		Pallet, Moving Walkway, 1138mm x 140mm
SCST-010	VS265271	Step, 1000K Step 9700-blk w/o n.rng or HK w/ SC
SEC-012	SLS243001	Schindler 9500 Unit, 1000mm movable walkway pallet
SEC-013	SLS243000	Schindler 9500 Unit, 800mm movable walkway pallet
SEC-016	S-SCS568549	Step, 1000mm silver step with yellow demarcation strips
SEC-021		Guide Pad, escalator step
SES-003	SMS405139	Escalator step, 1000mm
WE-41T	864A893H15	Step key, 11-1/2" L
WE-43	215B768H01	End plate, L.H.
WE-44	215B768H02	End plate, R.H.
WE-44A	X52S1H29	Screw for end plates
SCST-1A		Moving Walk Pallet, 1128mm x 140mm
SCST-1B		Moving Walk Pallet, 1138mm x 140mm
SCST-1C		Moving Walk Pallet, 928mm x 140mm
SCST-1D		Moving Walk Pallet, 938mm x 140mm

SCHINDLER / WESTINGHOUSE - Chains

S.E.E.S. #	O.E.M. #	Description
SE-1	498347-C	Chain
SE-3	SCH437468	Interm. Shaft
SE-5	741335	Chain, Escalator
SDO-024	741320A	Step Chain
SDO-025	SCH409585	Reversing Chain
SDO-026	SCS241457	Step Chain
SDO-026A		Master Link for SWE Chain

S.E.E.S. #	O.E.M. #	Description
WEW-8A	2898C84H13	Drive chain for handrail
WEW-8B	2898C84H14	Handrail Drive chain, 4/210 links
WEW-8C	NAA297454	Drive Chain, Esc Step, 93 Link 20B-2 9300-10
WEW-8D		Drive Chain, Esc. Step 20B-2 x 91 Links DIN 8187
SEW-006	498347-C	Roller Chain Assy, Newel SWE/SWU Style 2 Req 17 rollers, Reversing Pitch Line: 75 Width: 26mm Length: 1350mm Pulley Block
SCCH-1	SEH498347-C	Roller Chain Assembly, Newel SWE/SWU Style 2 Req 17 rollers
SCCH-3		Chain, Sidewalk T133.33
SCCH-4		Chain Roller, 70mm x 25mm, T133.33
SCCH-5	409585	Reversing Chain, Schindler Escalator
SEC-HDW-004	SUS499197	Escalator chain oiler brush
WE-103	694B780H01	Tire, for chain comp wheel 16.62" I.D.



SDO-024



SDO-026A



WEW-8A



WEW-8B



SEW-006



SCCH-1



SCCH-3



SCCH-5



SCCH-4



WE-20

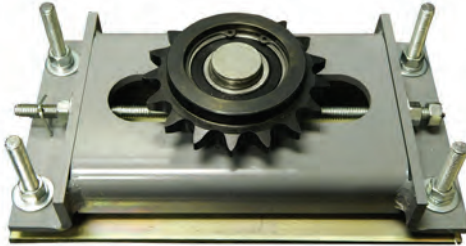

WE-20H

SCHINDLER / WESTINGHOUSE - Sprockets

S.E.E.S. #	O.E.M. #	Description
WE-20	691B734G01	Idler Sprocket, double 45 teeth
WE-20B	2898C89B01	Drive Sprocket, 45 teeth
WE-20D	2898C63H02	Drive Sprocket, 45 teeth
WE-20F	1724C26G03	Sprocket Assembly, includes WE-20D
WE-20G	1724C24G01, 5199D56G01	Dual Sprocket
WE-20H	5199D53G01	Handrail Idler Sprocket Assembly
WE-22	2898C70G01	Drive Sprocket, 17 teeth, 1.1811" I.D. sprocket side, .9843" I.D. shoulder side
WE-23	2898C70G02	Idler Sprocket, 17 teeth, 1.1811" I.D.
WE-24	2898C81H01	Handrail Drive Sprocket, 46 teeth
WE-25	R75998G05	Handrail Drive Sprocket, 35 teeth
WE-88	1724C18G01	Sprocket teeth split, MOD 250 46
SCCH-2		Chain Gear, Thick: 44mm, OD: 22.4mm



WE-22



WE-23



WE-24



WE-25



SCCH-2



SCIC-1



SCIC-2

SCHINDLER / WESTINGHOUSE - Inlet Covers

S.E.E.S. #	Description
SCIC-1	Inlet Cover
SCIC-2	Inlet Cover
SCIC-3	Rubber Inlet
SCIC-4	Inlet Brush



SCIC-3



SCIC-4

SCHINDLER / WESTINGHOUSE - Switches

S.E.E.S. #	O.E.M. #	Description
MISSW-2		Limit Switch , ZR231-11YR1881
WE-2	321C201G01	Hatch limit switch , normally close
WE-2A	321C201G02	Inching switch , normally open
WE-2B	144A362G01	Roller , only, for WE-2 & WE-2A
WE-30	7428C92H30	Safety Switch mechanical reset SPDT
WE-31	5063A04H01	Safety Switch , SPDT. No mechanical reset
WE-32	5063A04H02	Safety Switch , DPDT. No mechanical reset
WE-32A	5063A04H04	Escalator Safety Switch , DPDT
WE-33	864A928H01	Safety Switch , DPDT, combination
WE-34K	1727C81G03	Switch Skirt kit , Schindler
WE-59	1760C20G02	Switch , L.H., handrail
WE-60	1760C20G01	Switch , R.H., handrail
WE-62	2898C51G03	Switch , Broken chain switch
WE-70	692B226H02	Key Switch assembly, 2 position
WE-73	693B221H04	Key Switch assembly, 2 position, spring loaded, key# T112



MISSW-2



WE-2



WE-2A

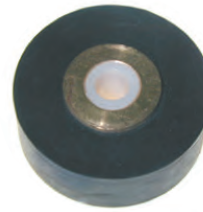

WE-2B



WE-30



WE-31



WE-32



WE-32A



WE-33



WE-59



WE-60



WE-62



WE-70



WE-73



WE-96



WE-98

SCHINDLER / WESTINGHOUSE - Switches

S.E.E.S. #	O.E.M. #	Description
WE-96	337202	Limit switch assembly
WE-98	337204	Limit switch, locked left
WE-110	6947C64G02	Escalator stop switch and cover
WE-110A	7431C23H01	Escalator stop switch cover for WE-110
WE-110B		Escalator stop switch, switch only
WEW-11A	96C125G03	Chain switch assembly, L.H.
WEW-11B	96C125G04	Chain switch assembly, R.H.
SEM-002	337205	Limit Switch locked right
SEM-003	337215	Limit Switch
SEM-007	337101	Limit Switch
SEM-008	299929	Switch, Escalator missing step proximity switch
SEM-011	HA-1600-CR2	Switch, Handrail Motion For Schindler MOD 100
SCL0-16	720Y	Key Switch, for Schindler 9300
SCL0-16S		Short Key Switch, for Schindler 9300



WE-110



WE-110A



WEW-11A



SEM-008



SEM-011



SCL0-16



SCL0-16S

SCHINDLER / WESTINGHOUSE - Switches

S.E.E.S. #	O.E.M. #	Description
WE-56	X50GS1H04	Reset switch, 5 amps @ 125 VAC, 1/2 AMP
WE-62	2898C51G03	Broken chain switch
WE-77	8538C91H03	Missing step switch
WE-87	8538C91H03	Missing step proximity switch



WE-56

S.E.E.S. #	O.E.M. #	Description
WE-18	694B930H01	Button Base, for safety switch
WE-18A	681A641H01	Button, nylon escalator button
WE-19	692B012G01	Cover for Escalator stop switch 2-7/8" x 3-5/8" x 5/16" plexiglass engraved and filled
WE-19A	692B012G01	Cover as above but bronze plexiglass
WE-19B	692B013H05	Spring, R.H. for switch cover
WE-19C	692B013H04	Spring, L.H., for switch cover
WE-19E	5405C61G04	Emergency Stop Switch Assembly, with Alarm and cover, 1 N.O., 1 N.C., MIS-19F included
WE-19E-SPECIAL		Emergency Stop Switch Assembly, with Alarm Special, 1 N.O., 1 N.C.
WE-19F	693B326G01	Lift Cover, for Emergency Stop Switch
WE-19F-SS	693B326G01-SS	Lift Cover Assy, for Emergency Stop Switch, SS Version



WE-87



WE-18



WE-18A



WE-19



WE-19C

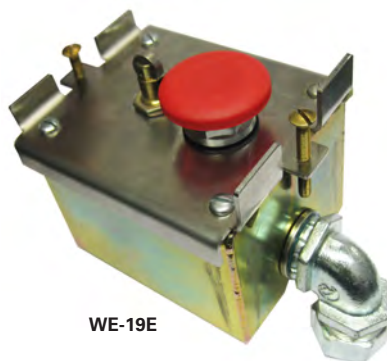

WE-19E



WE-19F

SCHINDLER / WESTINGHOUSE - Belts and Pulleys



WBLT-20



WE-8



WE-21



WE-74



S.E.E.S. #	O.E.M. #	Description
WBLT-20	691B789H05	Drive belt for "BB" & "BT" escalators, 1" wide, 140" circumference, 1/2" pitch
WBLT-20A	691B789H07	Drive belt, steel cord, for "BB" & "BT" escalators 1" wide, 170" circ., 1/2" pitch
MIS-BLT11	5211D92H09	Belt, 3V450, 45" circumference
MIS-BLT12	2898C66H10	Belt, 3V475, 47.5" circumference
MIS-BLT13	5211D92H08	Belt, 3V500, 50" circumference
MIS-BLT14	5211D92H07	Belt, 3V530, 53" circumference
MIS-BLT19	5211D92H17	Belt, 3V710, 71" circumference
MIS-BLT20	1298D56H30	Belt, 3V750, 75" circumference
MIS-BLT21	5211D92H16	Belt, 3V800, 80" circumference
MIS-BLT22	5211D92H18	Belt, 3V950, 95" circumference
MIS-BLT29		Belt, 3VX560, 56" circumference
MIS-BLT30	3R3VX530	Belt, 3 Rib Drive V 53" IG Westinghouse Escalator Drive Belt
MIS-BLT31	260J8	Belt, Gates 260J8 Micro-V Belt, 8 Rib J Sec. 260J Size, 26" L 3/4" W
SE-4	SMH273916	Handrail Belt
WE-8	196C269G01	Timing Drive Pulley, HR Drive Pulley, MOD 100
WE-21	5191D53G01	Drive Pulley, handrail, 84 teeth for WBLT-20 & WBLT-20A timing belts
WE-74	52311D92H03	Steel Pulley, 3-belt, 5.3"
WE-85	5211D92H01	Sheave, 3 belt, 10.6"
SCFP-1		Friction Pulley, OD: 588mm x 30mm, 8 Mounting Holes
SEW-002	310676	Friction Wheel, Schindler
SCBE-1		Multi-Wedge Rubber Belt
SCBE-2		Multi-Wedge Rubber Belt, Black L=1841MM
SCBE-3		Multi-Wedge Rubber Belt
SCBLT-001		Belt, Timing for Schindler, VARIDOR 30 8mm pitch 20mm wide 3500mm long



SCFP-1



SEW-002



WE-85



SCBE-3



SE-4

SCHINDLER / WESTINGHOUSE - PCBs

S.E.E.S. #	O.E.M. #	Description
SCPCB-28	598765	PCB Catalog
SCPCB-31	ID. NR. 590811	Escalator Board



SCPCP-28



SCPCB-31

SCHINDLER / WESTINGHOUSE - Lamps

S.E.E.S. #	O.E.M. #	Description
WE-46	865A144H02	Lamp Indicator Light assembly
SE-001	SRE38764324V	Light Fixture
SEM-006	334104	Escalator green flourescent lamp
SEM-006A	F15T8-G	Lamp, Tube flourescent green 18"



WE-46



SE-001



SEM-006



SEM-006A

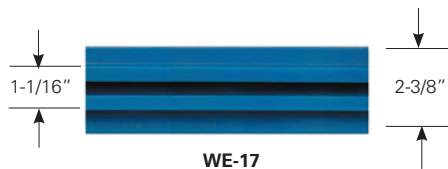
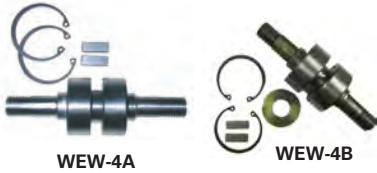

SCHINDLER / WESTINGHOUSE - Handrails

S.E.E.S. #	O.E.M. #	Description
WEW-4A	5199D18G05, 5193D54G05	Shaft & bearing double wide bearings, includes keys & retaining clips for shaft housing
WEW-4B	5199D18G05	Escalator Handrail Shaft , Double bearing new style
WE-80	1297D24G02	Drive channel , 4 hole
WE-80A	5199D18G09	Handrail drive assembly , complete 4-wheel
WE-81	5193D53G04	Drive channel , 6 hole, 3' 9-5/16" L x 3-7/8" W
WE-81A	692B14G02	Handrail drive assembly , complete 6-wheel
WE-16	630B226H05	Handrail guide track , J shaped plastic channel, specify length
WE-16A	864A976H01	Handrail guide , 12 foot length
WE-16B	5060A33H01	Handrail "J" track trim , .060" thick (100' coil)
WE-17	5060A88H01	Handrail guide , 2-3/8" W x 5' L
WE-17A	5060A88H01	Handrail guide , 2-3/8" W x 12' L
WE-17B	5060A88H02	Handrail guide , 24' section or cut to length
WE-1	626D142G01	Handrail brush , for type M or N escalator
WE-1A	103D291G03	Handrail brush , for modular units
SCPP-3		Joint Strip

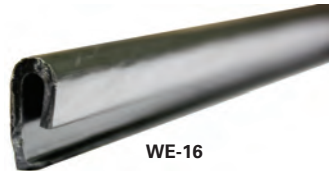

WE-16B

WE-16

WE-81A

WE-16A

WE-17

WE-17B

SCPP-3



SCHINDLER / WESTINGHOUSE - Transformers

S.E.E.S. #	O.E.M. #	Description
WE-55	630B775H01	Transformer , .32@600MA
WE-58	2633C05H01	Transformer , 200VA Primary voltage, 115/160 Secondary voltage
WE-58A	6925C91H01	Transformer , 450VA 230 Primary voltage, 115/160 Secondary voltage

SCHINDLER / WESTINGHOUSE - Motors

S.E.E.S. #	O.E.M. #	Description
WE-93	7428C77G05	Flywheel, Escalator motor
WE-94	2630C55H01	Motor, Escalator, 7.5 HP

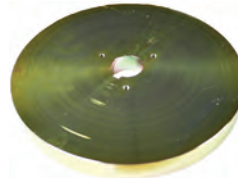

WE-93



WE-94

SCHINDLER / WESTINGHOUSE - Seals

S.E.E.S. #	O.E.M. #	Description
WE-35	RPO8001H03	Seal, Output shaft either side, 6-3/4" O.D., 4-1/2" I.D.
WE-36	RPO8001H01	Seal, Input shaft driven side 1-31/32" I.D., 4.331" O.D., width 3/8"
WE-37	RPO8001H02	Seal, Input shaft brake side 1.375" I.D., 4.331" O.D. width 3/8"
WE-38	7196D16H03, X30AS1H24	Seal, Brake
WE-39	X30AS2H47	Seal, Brake
WE-39B	2175C78G01	Seal split kit, 4.330" x 5.315" for gear case
WE-76	X30ES2H24	Seal, gear box
WE-86	X30ES2H24	Split Seal
WE-100	X30AS3H54	Input seal, for 220 220 x 30AS3H54



WE-35

WE-86



Front

WE-100

Back

SCHINDLER / WESTINGHOUSE - Brake Parts

S.E.E.S. #	O.E.M. #	Description
WE-41G	649B659H02	Gauge, Warner 825 brake
WE-48	RP08002H10	Arm, actuator, escalator brake
WE-82	2898G83G03	Glide stop brake assembly
SCBRA-1		Brake Right
SCBRA-2	897200	Brake, (single action solenoid) DF-SAS.S AC110/120V 50/60Hz
SCBRA-3	ID. NR. 296732	Brake Coil, 80V (11E 13E 14E 16E)
SCBRA-4		Brake Band
SEM-010	SWT463954	Brake Band Kit, Complete for SWE, SWT, SWU, EWE, EWG
WPC-205	5206D68H01	Brake, 48B/32B hi-rise Ogura
WPC-206	5206D68H02	Brake, 32B Rise <20' Ogura



WE-41G



WE-48

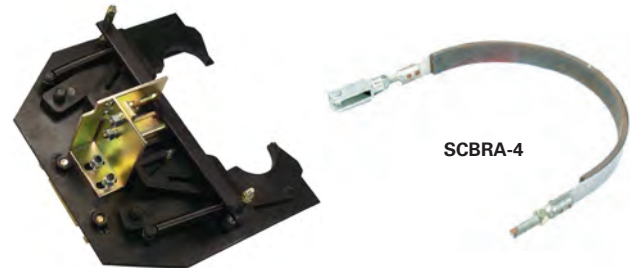

SCBRA-4



SCBRA-1



WE-82



WPC-206

SCHINDLER / WESTINGHOUSE - Electrical & Signal Parts



SEC-065

WE-53



WE-61



WE-57



WE-5



WE-79

S.E.E.S. #	O.E.M. #	Description
SC-200	SSB897396	Solenoid , for Brake 97 VDC
SEC-065	55A897200	Solenoid Assembly , Schindler Escalator Brake 110VAC
SES-001	345452	Escalator contactor , 3 pole with 120 AC coil
WE-53	196C493H04	Alarm Audible buzzer 120 VAC 2" O.D. with 7-1/2" leads
WE-57	865A136H01	Time Meter
WE-61	X45AD54H18	Glide Stop rectifier 10 Amp 400V
WE-79	691B955G04	Fuse Block kit , with 2 fuses
WE-83	X25D51H22	Terminal Block for Westinghouse
WER-01	6925C86H33	Resistor , 150 ohm 50 watt adjustable for escalator
WRT-5	M7488.2	Rectifier , 1-phase for Westinghouse escalator
WRT-6	342132	Rectifier Bridge



WE-83



WER-01



WRT-5

SCHINDLER / WESTINGHOUSE - Sensors



WE-5A

WE-5AA

S.E.E.S. #	O.E.M. #	Description
WE-5	864A978H02	Magnetic pickup speed sensor
WE-5A	1722C01H01	Zero speed sensor , digital magnetic
WE-5AA		Female Connector , Speed Sensor Socket & Strain Relief, (WE-5)
WE-5B	865A691H0	Sensor , temperature, 160 degrees
WE-5C	2898C94H05	Pulse wheel , 7-1/2" Diameter x 4-5/8" I.D. x 3/16" Thick, 180 teeth, for MOD 250
WE-5D	2898C99H03	Relay motion detector
WE-5E	2898C99H04	Relay motion detector
WE-5F	865A116H01	Power supply , 115 VAC - 90 VDC@1.25A
WE-27	2898C99H02	Reflex Photohead retroreflective photo unit
WE-54	2898C99H05	Reflector Prism reflector 5/8" diameter
SEM-009	337311CL3R	Sensor , Escalator RPM Monitor 24 VAC with 5 meter cable

WE-5B

WE-5C

WE-5D



WE-5E



WE-5F



WE-27



WE-54



SEM-009

SCHINDLER / WESTINGHOUSE - Misc. Hardware

S.E.E.S. #	O.E.M. #	Description
WE-26	1726C09H01	Stub Shaft
WE-26B	7428C71H01	Drive shaft MOD250
WE-26S	2898C60H03	Spacer
WE-28	X18RS1H01	Bearing, sprocket drive
WE-28A	X18B53H68	Bearing assembly
WE-28B	X18BS2H50	Bearing assembly
WE-34	1727C81G02	Plunger assembly
WE-34A	196C266H03	Actuator
WE-34B	X9BS3H59	Spring for plunger assembly
WE-34C	1727C81G0	Plunger assembly kit
WE-40	X4WS1-H03	Plug Nut, used on hinge cap
WE-41	864A925H01	Screw, socket head cap screw
WE-41R	144A541H01	O Ring, for WE-41 & WE-41S
WE-41S	864A925H02	Screw, stainless steel socket head cap screw 2-5/16" long, 5/16 -18 thread
WE-42	X6ZAS1H06	Ring, retaining for sprocket
WE-44B	K4715H01	Screw, Allen head, for trim
WE-47	X6ZS6H82	Ring, snap ring set (pkg/10)
WE-49A	2179C12G04	Bracket assembly, 8-3/4 x 7-1/4"
WE-50	691B738H01	Bearing assembly, fixed
WE-50B		Flange Bearing, Escalator Floating For Mod 100 Esc/Opp WE-50
WE-51	6929C24G02	Bushing set, standard 1.38" O.D. x 1.28" I.D. washers, spacers
WE-52	6929C24G01	Bushing set, oversize, 1.423" x 1.28" I.D.
WE-63	X6ZAS1H09	Retainer ring for MOD100
WE-64	X6ZS2H24	Retainer ring
WE-65	691B783H01	Bushing, Step Axle Neoprene
WE-66	X4QS1H07	Retaining nut, 3/8-16 Captive
WE-78	691B378H01	Bearing stub
WE-84	2633C066G01	Plate and Bushing Adapter assembly, with hardware
WE-89	691B873H01	Bushing, isolation
WE-90	865A099H02	Trim Retainer, 13" strip
WE-91	2898C54G02	Adjusting rod for mod 250 escalator
WE-92	5211D9H06	Bushing, taper lock, 1-15/16"
WE-95	5211D92H14	Bushing, taper lock, 1-5/8"
WE-99	X9ES3H62	Rod Spring, escalator idler adjuster, MOD 250



WE-26



WE-28



WE-34B



WE-34



WE-40



WE-41



WE-44A



WE-44B



WE-47

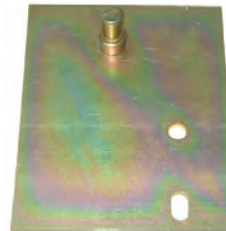

WE-49A



WE-50B



WE-90



WE-51



WE-65



WE-66



WE-84

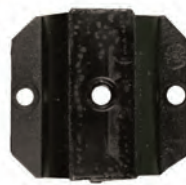

WE-89



WE-92



WE-95

SCHINDLER / WESTINGHOUSE - Misc. Hardware

S.E.E.S. #	O.E.M. #	Description
WEW-4K	X10DS1H35	Key way, 3/16" x 3/8" x 1"
WEW-4N		Nut, self-locking 3/4" nut for WEW-4A
WEW-11	196C126H07	Shoe, slack chain shoe
SCGP-1		Guide Piece 2 Holes
SCGP-2		Guide Piece 1 Hole
SEC-HDW-001	DIN798403	Escalator Comb Screw, Allen, flat head
SEC-HDW-002		Comb plate screw low SOC HD
SEC-HDW-003	NAA248864	Retaining ring
SEM-001	SUS496193	Escalator rod connector
SEW-003SB	R38-30-0442	Splice bar, Schindler, 3/4" x 8"
SCGS-14		Polyurethane Sliding Rail
SCGS-23		Polyurethane Sliding Rail
SCPP-1		Sliding piece
SCPP-2		Stopper
SCG-4		Aluminum Sector Rack, 120 x 70mm
SCMIB-720	KZ-720B	Inspection Box
SCPLG-1	PPG-16	Plug
SCPLG-2	ZGG-16	Socket
SCST-8		Pallet Buckle
SCCD-1		Automatic Closing Device, For Rope

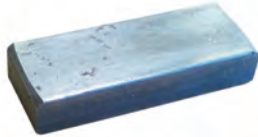

WEW-4K



WEW-11



SCGP-1



SCGP-2



SEC-HDW-003



SEC-HDW-002



SEC-HDW-001



SEW-003SB



SCGS-14



SCGS-23



SCPP-2



SCMIB-720



SCPP-1

Miscellaneous Escalator Parts

S.E.E.S. #	O.E.M. #	Description
MISWH-11		Support Roller Assembly
MISYDS-1		Screw , for Demarcation Strip 3.5mm diameter, L24MM
MISGL-1		Guide Rail , Tangential Polyurethane
MISGL-2		Guide , Tangential Nylon, left
MISGP-1		Guide Piece , for Schindler
MISOC-1		Oil Can
MISSS-3		Photo Electric Sensor , TELCO
MISEB-1	LA-720P	Stop button
MISERL-1		Escalator Green Light
MISDL-1		Arrow Light
MISDL-2		Arrow Light , :Φ59mm, :4-Φ7.5 48mm × 48mm
MISDL-3		Arrow Light , :Φ59mm, :4-Φ7.5 48mm × 48mm
KLCH-1		Canny Step Chain , Pitch=133.5mm, Roller: 75mm × 25mm, 6204
KLCP-1C		Canny Comb Plate , Middle
KLCP-1L		Canny Comb Plate , Left
KLCP-1R		Canny Comb Plate , Right
KLYDS-1L		Canny Demarcation Strip , Left
KLYDS-1R		Canny Demarcation Strip , Right
KLYDS-1C		Canny Demarcation Strip , Middle
VPC-001		Vermaport Cone , for Shopping Carts Escalators



MISDL-1



MISDL-2



MISDL-3



MISEB-1



MISERL-1



MISGL-1



MISOC-1



MISGP-1



MISGL-2

get SILLY!



See page 241
in the
SEES
Catalog

SEES sells SILLS by the Seashore.

IN STOCK: Aluminum Hatch and Car Sills, all types...



@SEESinc



SEESinc.com/blogs



SEESinc

Always Smooth Sailing



2781 West McNab Rd., Pompano Beach, FL 33069 • 800-526-0026 • www.SEESinc.com

SOUTHERN ELEVATOR
& ELECTRIC SUPPLY

CONSTRUCTION - MODERNIZATION QUICK LOCATOR GUIDE

Boxes, Plates and Electrical	155-156
Cable Cross Section, Standards and Insulation Color Key	118-119
Compensation Cable and Devices	176-182
Conduit, Flexible and Fittings	153
Door Lock Wire	140
EMT Fittings	150-152
Fasteners	200
Flat Cable Suspension Devices	135-137
Governors	212
Hardware for Electrical Work	198-199
Hook-up Wire	141-142
Hoistway Cable, Super-Duct	138-139
Hoistway/Hatch Switches	213-215
Hoistway Safety	209-210
Inspection Stations and Stop Switches	206
Junction Boxes and Knockout Punches/Plugs	157
LED Lighting Systems	202-205
Load Weighing Devices	174-175
Mesh Grips	129-131
Metal Wireway and Fittings	145-149
Pendant Stations	207
Pit Safety Kits, Car Escape Hatch Switches and Exhaust Fans	211
Power, Signal and Communication Cable	143
Rail Mounting Hardware	185-186
Rails, Ferrules, Connectors	144
Rope Brake	166
Rope Tensioning System	172-173
Round Cable Hanging Components	128
Seismic Detection Equipment	184
Sheaves, Deflecting and Pulleys	187
Stationary Cable	140
Strut	201
Threaded Fittings for Rigid Pipe	154
Tools	191-197
Top of Car Safety Rails	208
Traveling Cable, Flat	132-134
Traveling Cable, Super-Flex	120-127
Valve, Fittings and Accessories	188-190
Wire Rope	158-165
Wire Rope Accessories	170
Wire Rope Lubrication	171
Wire Rope Wedge Sockets	167-169



Internal Components FOR DRAKA ELEVATOR CABLES

Special constructions are available!

Draka offers Type EO cables for wet/hazardous locations, halogen-free cables and custom configurations.

Contact your local Draka representative for details.

Traveling and hoistway cables

Jacket – Black, 70° C polyvinyl chloride specifically compounded for flexibility and abrasion resistance. The finished cable complies with ANSI/ASTM, UL and CSA standards. It also meets EN or JIS requirements as needed and the UL VW-1 or UL-1581 and CSA FT1 flame requirements. Operating temperatures range from -15° C to +70° C. Optional rugged polyurethane (PUR) jackets are available upon request. Operating temperatures for PUR cables range from -20° C to +70° C. Please contact Draka engineering if you are planning to operate an elevator at temperatures below 0° C.

Any traveling cable can be custom-made with halogen-free materials.

Binder – Helically-wound synthetic fiber provides maximum strength.

Braid – A textile braid is applied over the core assembly with 95% coverage.

Stranded Conductors – Bunch-stranded bare soft drawn copper. AWG sizes comply with ANSI/ASTM B174, ANSI/ASTM B3 and with Type ETT requirements of UL 62 and CSA C22.2 No. 49. Metric sizes meet the intent of EN50214, JIS 3408 and AS.

Insulation – 70° C, colored, flame-retardant polyvinyl chloride to exceed ETT requirements of UL 62 and CSA C22.2 No. 49. Also complies with EN and JIS requirements for elevator control cables.

Identification – Each insulated conductor and shielded pair is positively identified by an insulation color or a combination of insulation color and numerical markings appearing four times/foot • thirteen times/meter.

Steel Support for Round Traveling Cables – Preformed, flexible, low torsion, zinc-coated, steel wire rope in accordance with applicable portions of Military Specification MIL-W-83420. The steel support is insulated with 70° C flame-retardant polyvinyl chloride (Super-Flex® cables have the steel covered with a rayon or cotton braid). Complies with ANSI/ASTM, UL and CSA requirements.

Steel Support for Flat Traveling Cables – Preformed, flexible, low torsion, zinc-coated, steel wire rope in accordance with applicable portions of Military Specification MIL-W-83420. Complies with ANSI/ASTM, UL and CSA requirements.

Shielded Pairs – 20 AWG insulated conductors, paired together with a short lay twist, shielded with 36 AWG bare copper braid (85% coverage). Laminated foil shielded pairs are also available. They are jacketed with colored, flame-retardant 70° C polyvinyl chloride and comply with international requirements.

Jute Filler – Individual core interstice fillers distribute interlayer pressure and reduce conductor friction. All fillers are electrical-grade dry jute.

Regarding UTP communications cables

NEC code 620.12 A does not allow any conductor smaller than 20 AWG within traveling cable. Therefore, Cat5, Cat5e, and Cat6 UTP are not an option for traveling cable.

Coaxial cable specifications

RG6/U Coaxial Cable – Primarily for CCTV applications. 75 ohm, UL listed, CSA certified. Center conductor is 20 AWG stranded copper insulated with cellular polyethylene, wrapped with aluminum tape, braided with tinned copper and jacketed with flame-retardant PVC.

Attenuation is 2.13 dB/100m @ 10 MHz and 5.08 dB/100m @ 50 MHz. Capacitance measures 56.7 pf/m.

RG11/U Coaxial Cable – Optional 75 ohm, UL listed. Center conductor is 14 AWG • 2.0 mm² soft drawn stranded copper insulated with cellular polyethylene, braided with bare copper for 97% coverage, and jacketed with flame-retardant PVC.

Attenuation is 2.16 dB/100m @ 10 MHz and 4.26 dB/100m @ 50 MHz. Capacitance measures 56.7 pf/m.

Fiber optic specifications

62.5/125 micron (OM1) tight-buffered multimode optical fiber, covered with high-strength aramid yarn and jacketed with flame-retardant polyvinyl chloride.

Maximum attenuation is 3.75 dB/km @ 850 nm and 1.5 dB/km @ 1300 nm.

Minimum bandwidth is 160 MHz•km @ 850 nm and 500 MHz•km @ 1300 nm.

Other optical fibers are available including 50/125 micron (OM2) multimode, 50/125 micron (OM3) laser-optimized multimode, and single mode.

Super-Flex round cable cross-section (typical)

PVC jacket – halogen-free compounds available

Braid and binder

Stranded conductors

- 18 AWG
- 16 AWG
- 14 AWG
- 12 AWG

Steel support

Shielded pair

20 AWG

RG6/U coaxial

RG11/U coaxial and

optical fiber are

also available

Jute filler

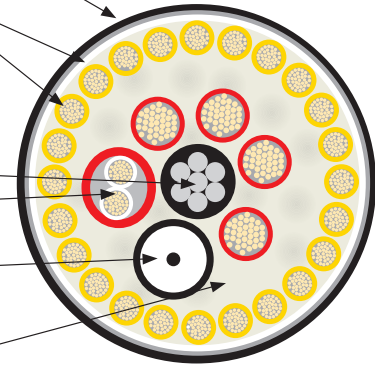

Flat cable cross-section (typical)

PVC jacket – halogen-free styles available

Stranded conductors

- 18 AWG
- 16 AWG
- 14 AWG

Shielded pair

20 AWG

Ripcord



Standards and Insulation Color Key FOR DRAKA ELEVATOR CABLES

Standards and certifications



ISO 9001
Draka Elevator's Rocky Mount manufacturing and distribution center were assessed and accredited for ISO 9001 Quality Management System by SGS/UKAS.



ISO 14001
Draka has been accredited for ISO 14001 Environmental Management Systems by SGS/UKAS.



OHSAS 18001
Draka has been audited and certified for Occupational Health and Safety Management Systems by SGS/UKAS.



UL Listed
Listed cables are approved for use in the US and meet all pertinent requirements of Underwriter's Laboratories.



NEC Compliant
Compliant cables meet all pertinent requirements of the 2011 National Electric Code.



CSA Certified
Certified cables meet all pertinent requirements of the Canadian Standards Association.



US Dept. of Labor Mine Safety
Approved cables meet all pertinent requirements of the US DOL for mine safety.



Bureau Veritas
ETT round traveling cables are certified and approved for marine and offshore applications.

Pennsylvania Bureau of Deep Mine Safety
Approved cables meet all pertinent requirements of the PBDMS.

IEC Compliant
Compliant cables are approved for use in Europe and meet IEC requirements.

JIS (Japanese Standards)
Compliant cables are available upon request.
Please consult all local regulations and codes prior to ordering cables. Some Draka Elevator cables are manufactured to meet the specific codes of a country or region and may not be applicable for your application.

Color codes

14 AWG conductors

Conductor Number(s)	Insulation Color
1*	Black
2*	White
3*	Green
4 to 10	Lavender
11 to 20	Orange
21 to 30	Tan

*No printed numbers.

If the cable has only 4 conductors, the #4 lavender is not numbered.

16 AWG and 18 AWG conductors

Conductor Number(s)	Insulation Color
1 to 10	Yellow
11 to 20	Orange
21 to 30	Tan
31 to 40	Blue
41 to 50	Red
51 to 60	Grey
61 to 70	Black
71 to 80	Pink
81 to 90	Brown

Shielded pair 20 AWG

Pair Number(s)	Jacket Color	Insulation Color
1	Red	Red/White
2	Black	Red/White
3	Yellow	Red/White
4	Orange	Red/White
5	Tan	Red/White
6	Blue	Red/White
7	Grey	Red/White
8	Pink	Red/White
9	Red	Black/White
10	Black	Black/White
11	Yellow	Black/White
12	Orange	Black/White
13	Tan	Black/White
14	Blue	Black/White
15	Grey	Black/White
16	Pink	Black/White

AWG to metric conversions

AWG	Metric equivalent
12 AWG	3.31 mm ² - 65 strands
14 AWG	2.08 mm ² - 41 strands
16 AWG	1.31 mm ² - 26 strands
18 AWG	0.82 mm ² - 16 strands
20 AWG	0.52 mm ² - 10 strands



Super-Flex® Traveling Cable Type ETT/300V

JUTE CENTER - UL LISTED, CSA CERTIFIED, NEC/CEC COMPLIANT - LIFETIME WARRANTY

Power and signal conductors



Part Number	Product Code	Number/Size of Conductors	Max. Hang Length feet • meters	Cable Nom. OD inches • mm	Cable Net Weight lbs/kft • kg/km
18-406-03	J 6-18 SP [†]	6 / 18 AWG Insulation colors: green, yellow, blue, red, black, white	200 • 61	0.43 • 10.9	96 • 143
18-410-01	J 10-18	10 / 18 AWG	200 • 61	0.54 • 13.7	160 • 238
18-416-01	J 16-18	16 / 18 AWG	200 • 61	0.64 • 16.3	219 • 326
18-420-01	J 20-18	20 / 18 AWG	200 • 61	0.71 • 18.0	266 • 396
18-424-01	J 24-18	24 / 18 AWG	200 • 61	0.73 • 18.5	304 • 452
18-430-01	J 30-18	30 / 18 AWG	200 • 61	0.82 • 20.8	378 • 562
18-440-01	J 40-18	40 / 18 AWG	200 • 61	0.92 • 23.4	475 • 707

[†]"SP" denotes special color coding and/or conductor numbering.



Shielded pairs



Part Number	Product Code	Number/Size* of Conductors	Max. Hang Length feet • meters	Cable Nom. OD inches • mm	Cable Net Weight lbs/kft • kg/km
18-102-28	JCC 4x20SH	4 shielded pairs / 20 AWG	200 • 61	0.79 • 20.1	270 • 402
18-008-14	JCC 8x20SH	8 shielded pairs / 20 AWG	200 • 61	1.00 • 25.4	420 • 625



Use these tools to prepare Super-Flex traveling cable.

#36-060 FlexiPeeler™
round cable stripper



#36-146 Super Peeler
round cable stripper



#36-177 Sock Slicer™



#17-05-0001 QuickStrip
wire stripper



#36-219 Automatic
wire stripper



#37-177 Manual
wire stripper



This catalog shows a sample of product offering. Please call if you require a custom design.

Super-Flex® Traveling Cable Type ETT/300V

JUTE CENTER – UL LISTED, CSA CERTIFIED, NEC/CEC COMPLIANT – LIFETIME WARRANTY

Power, signal and shielded pairs



Part Number	Product Code	Number/Size of Conductors	Max. Hang Length feet • meters	Cable Nom. OD inches • mm	Cable Net Weight lbs/kft • kg/km
18-017-02	JC 17	3 / 16 AWG 8 / 18 AWG 3 shielded pairs / 20 AWG	200 • 61	0.95 • 24.1	350 • 521
18-027-02	JC 27	3 / 14 AWG 20 / 18 AWG 2 shielded pair / 20 AWG	200 • 61	0.94 • 23.8	466 • 693
18-322-05	JC 33 SP [†]	3 / 14 AWG 22 / 18 AWG 4 shielded pair / 20 AWG	200 • 61	1.23 • 31.2	719 • 1070
18-431-02	JC 37	4 / 14 AWG 31 / 18 AWG 1 shielded pair / 20 AWG	200 • 61	1.00 • 2.54	672 • 1000
18-038-02	JC 38 W	12 / 14 AWG 18 / 18 AWG 4 shielded pair / 20 AWG	200 • 61	1.25 • 31.8	806 • 1199
18-838-02	JC 38 SP [†]	8 / 14 AWG 24 / 18 AWG 3 shielded pair / 20 AWG	200 • 61	1.25 • 31.8	777 • 1157
18-842-02	JC 42 SP-HI [†]	26 / 18 AWG 8 shielded pair / 20 AWG	200 • 61	1.16 • 29.5	700 • 1042
18-044-05	JC 44 SP [†]	8 / 14 AWG 30 / 18 AWG 3 shielded pair / 20 AWG	200 • 61	1.32 • 33.5	797 • 1186
18-032-99	JC 45	4 / 14 AWG 39 / 18 AWG 1 shielded pair / 20 AWG	200 • 61	0.99 • 25.1	617 • 918
18-045-02	JC 45 D	4 / 14 AWG 31 / 18 AWG 5 shielded pair / 20 AWG	200 • 61	1.31 • 33.3	805 • 1198
18-847-02	JC 46	8 / 14 AWG 30 / 18 AWG 4 shielded pair / 20 AWG	200 • 61	1.26 • 32.0	825 • 1228
18-445-02	JC 51	4 / 14 AWG 45 / 18 AWG 1 shielded pair / 20 AWG	200 • 61	1.20 • 30.5	757 • 1126
18-051-02	JC 51 D	4 / 14 AWG 41 / 18 AWG 3 shielded pair / 20 AWG	200 • 61	1.28 • 32.0	880 • 1309
18-752-02	JC 52-0/SP [†]	10 / 14 AWG 42 / 18 AWG	200 • 61	1.22 • 31.0	840 • 1250
18-055-02	JC 55 D	4 / 14 AWG 41 / 18 AWG 5 shielded pair / 20 AWG	200 • 61	1.39 • 35.3	917 • 1365



[†]“SP” denotes special color coding and/or conductor numbering.
RG11/U coax and multimode optical fiber are available as options.



Super-Flex® Traveling Cable Type ETT/300V

JUTE CENTER - UL LISTED, CSA CERTIFIED, NEC/CEC COMPLIANT - LIFETIME WARRANTY

Power, signal and shielded pairs



Part Number	Product Code	Number/Size of Conductors	Max. Hang Length feet • meters	Cable Nom. OD inches • mm	Cable Net Weight lbs/kft • kg/km
18-057-02	JC 57	6 / 14 AWG 45 / 18 AWG 3 shielded pair / 20 AWG	200 • 61	1.39 • 35.3	943 • 1403
18-059-02	JC 59	4 / 14 AWG 49 / 18 AWG 3 shielded pair / 20 AWG	200 • 61	1.22 • 30.1	872 • 1298
18-454-02	JC 60	4 / 14 AWG 54 / 18 AWG 1 shielded pair / 20 AWG	200 • 61	1.26 • 32.0	855 • 1272
18-456-02	JC 66	4 / 14 AWG 56 / 18 AWG 3 shielded pair / 20 AWG	200 • 61	1.33 • 33.8	955 • 1421
18-X66-02	JCX 66-6	15 / 14 AWG • 2.0 32 / 18 AWG • 0.75 9 shielded pair / 20 AWG 1 coax / RG6/U	200 • 61	1.68 • 42.7	1345 • 2002
18-073-02	JC 73	6 / 14 AWG 61 / 18 AWG 3 shielded pair / 20 AWG	200 • 61	1.35 • 34.3	1042 • 1551
18-173-05	JC 73 O [†]	12 / 14 AWG 53 / 18 AWG 4 shielded pair / 20 AWG	200 • 61	1.43 • 39.3	1118 • 1664
18-174-05	JC 74 O [†]	12 / 14 AWG 53 / 18 AWG 4 shielded pair / 20 AWG 1 coax / RG6/U	200 • 61	1.47 • 37.3	1200 • 1786
18-076-02	JC 76	66 / 18 AWG 5 shielded pair / 20 AWG	200 • 61	1.42 • 36.1	1017 • 1513
18-764-05	JC 79 SP [†]	7 / 14 AWG 64 / 18 AWG 4 shielded pair / 20 AWG NOTE: 14 AWG conductor #7 is dark blue	200 • 61	1.45 • 36.8	1200 • 1786
18-476-02	JC 86	4 / 14 AWG 76 / 18 AWG 3 shielded pair / 20 AWG	200 • 61	1.39 • 35.3	1128 • 1679
18-490-02	JC 90	4 / 14 AWG 76 / 18 AWG 5 shielded pairs / 20 AWG	200 • 61	1.49 • 37.8	1247 • 1856
18-096-02	JC 96	86 / 18 AWG 5 shielded pair / 20 AWG	200 • 61	1.42 • 36.1	1180 • 1756
18-496-02	JC 96C	4 / 14 AWG 90 / 18 AWG 1 shielded pair / 20 AWG	200 • 61	1.42 • 35.8	1240 • 1846



[†]"SP" or "O" denotes special color coding and/or conductor numbering.
RG11/U coax and multimode optical fiber are available as options.

Use these tools to prepare Super-Flex traveling cable.

#36-060 FlexiPeeler™
round cable stripper



#36-146 Super Peeler
round cable stripper



#36-177 Sock Slicer™



#17-05-0001 QuickStrip
wire stripper



#36-219 Automatic
wire stripper



#37-177 Manual
wire stripper



This catalog shows a sample of product offering. Please call if you require a custom design.

Super-Flex® Traveling Cable Type ETT/300V

STEEL CENTER – UL LISTED, CSA CERTIFIED, NEC/CEC COMPLIANT – LIFETIME WARRANTY

Power and signal conductors



Part Number	Product Code	Number/Size of Conductors	Steel Core Dia. inches • mm	Max. Hang Length [†] feet • meters	Cable Nom. OD inches • mm	Cable Net Weight lbs/kft • kg/km
18-004-11	WS 4-14	4 / 14 AWG	3/32 • 2.4	900 • 275	0.57 • 14.4	166 • 247
18-008-11	WS 8-14	8 / 14 AWG	1/8 • 3.2	900 • 275	0.70 • 17.8	293 • 436
18-015-11	WS 15-14	15 / 14 AWG	1/8 • 3.2	900 • 275	0.93 • 23.6	487 • 725
18-310-11	WS 10-18	10 / 18 AWG	3/32 • 2.4	900 • 275	0.56 • 14.2	175 • 260
18-412-11	WS 12-18	12 / 18 AWG	3/32 • 2.4	900 • 275	0.65 • 16.5	280 • 417
18-420-11	WS 20-18	20 / 18 AWG	3/32 • 2.4	804 • 245	0.71 • 18.0	286 • 426
18-430-11	WS 30-18	30 / 18 AWG	1/8 • 3.2	900 • 275	0.82 • 20.8	417 • 620
18-440-11	WS 40-18	40 / 18 AWG	1/8 • 3.2	900 • 275	0.92 • 23.4	509 • 757
18-450-11	WS 50-18	50 / 18 AWG	1/8 • 3.2	795 • 242	1.01 • 25.7	629 • 936



600V power conductors



Part Number	Product Code	Number/Size of Conductors	Steel Core Dia. inches • mm	Max. Hang Length [†] feet • meters	Cable Nom. OD inches • mm	Cable Net Weight lbs/kft • kg/km
18-104-11	WS 4-12	4 / 12 AWG	1/8 • 3.2	900 • 275	0.74 • 18.8	279 • 415
18-022-12	CWS 22	10 / 10 AWG 12 / 12 AWG	1/4 • 6.4	900 • 275	1.50 • 38.2	1437 • 2138



Shielded pairs only



Part Number	Product Code	Number/Size of Conductors	Steel Core Dia. inches • mm	Max. Hang Length [†] feet • meters	Cable Nom. OD inches • mm	Cable Net Weight lbs/kft • kg/km
18-002-15	WSCC 4x20 SH	4 shielded pair / 20 AWG	1/8 • 3.2	900 • 275	0.79 • 20.0	330 • 491
18-003-15	WSCC 6x20 SH	6 shielded pair / 20 AWG	1/8 • 3.2	900 • 275	0.85 • 21.6	365 • 543
18-004-15	WSCC 8x20 SH	8 shielded pair / 20 AWG	5/32 • 4.0	900 • 275	1.00 • 25.4	490 • 729
18-403-15	WSCC 6x18 SH	6 shielded pair / 18 AWG	5/32 • 4.0	900 • 275	0.93 • 23.6	418 • 622
18-407-15	WSCC 14x18 SH	14 shielded pair / 18 AWG	5/32 • 4.0	714 • 218	1.44 • 36.6	981 • 1460

[†]For longer hang length applications, call with your requirements.
RG11/U coax and multimode optical fiber are available as options.



CONSTRUCTION / MODERNIZATION



Super-Flex® Traveling Cable Type ETT/300V

STEEL CENTER - UL LISTED, CSA CERTIFIED, NEC/CEC COMPLIANT - LIFETIME WARRANTY

Power, signal and shielded pairs



Part Number	Product Code	Number/Size of Conductors	Steel Core Dia. inches • mm	Max. Hang Length ¹ feet • meters	Cable Nom. OD inches • mm	Cable Net Weight lbs/kft • kg/km
18-011-12	CWS 11	6 / 12 AWG 5 / 14 AWG	1/8 • 3.2	900 • 275	0.97 • 24.6	512 • 762
18-020-12	CWS 20	14 / 18 AWG 3 shielded pairs / 20 AWG	3/32 • 2.4	612 • 187	0.95 • 24.1	376 • 560
18-421-12	CWS 27	4 / 14 AWG 21 / 18 AWG 1 shielded pair / 20 AWG	5/32 • 4.0	900 • 275	0.96 • 24.4	500 • 744
18-431-12	CWS 37	4 / 14 AWG 31 / 18 AWG 1 shielded pair / 20 AWG	5/32 • 4.0	900 • 275	1.18 • 30.0	700 • 1042
18-044-12	CWS 44	14 / 14 AWG 24 / 18 AWG 3 shielded pairs / 20 AWG	5/32 • 4.0	753 • 230	1.33 • 33.8	929 • 1382
18-045-12	CWS 45 D	4 / 14 AWG 31 / 18 AWG 5 shielded pairs / 20 AWG	5/32 • 4.0	776 • 237	1.31 • 33.3	902 • 1342
18-A46-12	CWS 46	8 / 14 AWG 30 / 18 AWG 4 shielded pairs / 20 AWG	5/32 • 4.0	769 • 234	1.32 • 33.5	910 • 1354
18-441-12	CWS 47	4 / 14 AWG 41 / 18 AWG 1 shielded pair / 20 AWG	5/32 • 4.0	900 • 275	1.20 • 30.5	771 • 1147
18-47L-12	CWS 47 LO	11 / 14 AWG (conductors are numbered 1 to 11) 22 / 18 AWG (conductors are numbered 1 to 22) 7 shielded pairs / 20 AWG (red/white pairs in red, black, yellow orange, tan, blue and gray jackets)	5/32 • 4.0	695 • 212	1.40 • 35.6	1012 • 1498
18-648-12	CWS 56	6 / 14 AWG 48 / 18 AWG 1 shielded pair / 20 AWG	5/32 • 4.0	826 • 252	1.20 • 30.5	847 • 1260
18-L58-12	CWS 58 LO	4 / 14 AWG (conductors are numbered 1 to 4) 40 / 18 AWG (conductors are numbered 1 to 40) 7 shielded pair / 20 AWG (red/white pairs in red, black, yellow, orange, tan, blue and gray jackets)	5/32 • 4.0	622 • 190	1.51 • 38.4	1125 • 1674



¹For longer hang length applications, call with your requirements.
RG11/U coax and multimode optical fiber are available as options.

Use these tools to prepare Super-Flex traveling cable.

#36-060 FlexiPeeler™
round cable stripper



#36-146 Super Peeler
round cable stripper



#36-177 Sock Slicer™



#17-05-0001 QuickStrip
wire stripper



#36-219 Automatic
wire stripper



#36-178 Steel core
cutter



This catalog shows a sample of product offering. Please call if you require a custom design.

Super-Flex® Traveling Cable Type ETT/300V

STEEL CENTER – UL LISTED, CSA CERTIFIED, NEC/CEC COMPLIANT – LIFETIME WARRANTY

Power, signal and shielded pairs



Part Number	Product Code	Number/Size of Conductors	Steel Core Dia. inches • mm	Max. Hang Length [†] feet • meters	Cable Nom. OD inches • mm	Cable Net Weight lbs/kft • kg/km
18-H58-12	CWS 58 HI	4 / 14 AWG (conductors are numbered 5 to 8 [dark blue]) 40 / 18 AWG (conductors are numbered 41 to 80) 7 shielded pair / 20 AWG (black/white pairs in red, black, yellow, orange, tan, blue and gray jackets)	5/32 • 4.0	622 • 190	1.51 • 38.4	1125 • 1674
18-059-12	CWS 59	4 / 14 AWG 49 / 18 AWG 3 shielded pair / 20 AWG	5/32 • 4.0	791 • 241	1.22 • 31.0	885 • 1317
18-X60-12	CWS 60	7 / 14 AWG 27 / 18 AWG 13 shielded pair / 20 AWG	1/4 • 6.4	900 • 275	1.58 • 40.1	1289 • 1918
18-869-12	CWS 69 SP	15 / 14 AWG 38 / 18 AWG 8 shielded pair / 20 AWG	5/32 • 4.0	518 • 158	1.58 • 40.1	1350 • 2009
18-661-12	CWS 71	6 / 14 AWG 61 / 18 AWG 2 shielded pair / 20 AWG	5/32 • 4.0	614 • 187	1.39 • 35.3	1140 • 1696
18-073-12	CWS 73	6 / 14 AWG 61 / 18 AWG 3 shielded pair / 20 AWG	5/32 • 4.0	608 • 185	1.39 • 35.3	1151 • 1709
18-X74-12	CWS 74	20 / 14 AWG 38 / 18 AWG 8 shielded pair / 20 AWG	5/32 • 4.0	491 • 150	1.54 • 39.1	1426 • 2122
18-469-12	CWS 75	4 / 14 AWG 69 / 18 AWG 1 shielded pair / 20 AWG	5/32 • 4.0	663 • 202	1.38 • 35.0	1056 • 1571
18-881-12	CWS 81	8 / 14 AWG 59 / 18 AWG 7 shielded pair / 20 AWG	5/32 • 4.0	524 • 160	1.60 • 40.6	1336 • 1988
18-X90-12	CWS 90	6 / 14 AWG 80 / 18 AWG 2 shielded pair / 20 AWG	5/32 • 4.0	555 • 169	1.46 • 37.1	1262 • 1878
18-X94-12	CWS 94	12 / 14 AWG 70 / 18 AWG 6 shielded pair / 18 AWG	1/4 • 6.4	900 • 275	1.68 • 42.7	1663 • 2475
18-096-12	CWS 96	86 / 18 AWG 5 shielded pair / 20 AWG	5/32 • 4.0	576 • 176	1.42 • 36.1	1215 • 1808



[†]For longer hang length applications, call with your requirements.
RG11/U coax and multimode optical fiber are available as options.

Use these tools to prepare Super-Flex traveling cable.

#36-060 FlexiPeeler™
round cable stripper

#36-146 Super Peeler
round cable stripper

#36-177 Sock Slicer™

#17-05-0001 QuickStrip
wire stripper

#36-219 Automatic
wire stripper

#36-178 Steel core
cutter



This catalog shows a sample of product offering. Please call if you require a custom design.



Super-Flex® Traveling Cable Type ETT/300V

STEEL CENTER – UL LISTED, CSA CERTIFIED, NEC/CEC COMPLIANT – LIFETIME WARRANTY

Power, signal, shielded pairs and coax



Part Number	Product Code	Number/Size of Conductors	Steel Core Dia. inches • mm	Max. Hang Length ¹ feet • meters	Cable Nom. OD inches • mm	Cable Net Weight lbs/kft • kg/km
18-X05-13	CSX 5	3 / 14 AWG 2 coax / RG6/U	5/32 • 4.0	900 • 275	1.13 • 28.7	500 • 742
18-309-13	CSX 9	4 / 14 AWG 2 shielded pairs / 20 AWG 1 coax / RG6/U	5/32 • 4.0	900 • 275	0.87 • 22.1	370 • 550
18-214-13	CSX 14	6 shielded pairs / 20 AWG 2 coax / RG6/U	5/32 • 4.0	900 • 275	1.06 • 26.9	570 • 848
18-X18-13	CSX 18-6	8 shielded pair / 20 AWG 2 RG6/U coax	5/32 • 4.0	900 • 275	1.24 • 31.5	710 • 1056
18-X36-13	CSX 36	17 / 14 AWG 8 shielded pairs / 20 AWG 3 coax / RG6/U	1/4 • 6.4	900 • 275	1.61 • 40.9	1271 • 1891
18-X46-13	CSX 46	11 / 14 AWG 22 / 18 AWG 6 shielded pairs / 20 AWG 1 coax / RG6/U	5/32 • 4.0	683 • 208	1.44 • 36.6	1025 • 1525
18-X47-13	CSX 47	4 / 14 AWG 30 / 18 AWG 6 shielded pairs / 20 AWG 1 coax / RG6/U	5/32 • 4.0	740 • 226	1.35 • 34.3	946 • 1408
18-247-13	CSX 47 0	8 / 14 AWG 30 / 18 AWG 4 shielded pair / 20 AWG 1 coax / RG6/U	5/32 • 4.0	642 • 196	1.41 • 35.8	1090 • 1622
18-H49-13	CSX 49 SP-HI ^{††}	20 / 18 AWG 14 shielded pair / 20 AWG 1 coax / RG6/U	5/32 • 4.0	659 • 201	1.50 • 38.1	1063 • 1582
18-X53-13	CSX 53	4 / 14 AWG 45 / 18 AWG 1 shielded pair / 20 AWG 2 coax / RG6/U	5/32 • 4.0	711 • 217	1.34 • 34.0	985 • 1466
18-X55-13	CSX 55	4 / 14 AWG 46 / 18 AWG 2 shielded pair / 20 AWG 1 RGS9/U coax	5/32 • 4.0	792 • 241	1.21 • 30.7	883 • 1314
18-055-13	CSX 55 SP ^{††}	4 / 14 AWG 46 / 18 AWG 2 shielded pair / 20 AWG 1 coax / RG6/U	5/32 • 4.0	791 • 241	1.22 • 31.0	885 • 1317
18-855-13	CSX 55 SP ^{††} HI NUMBERS	26 / 18 AWG 14 shielded pair / 20 AWG 1 coax / RG6/U	5/32 • 4.0	649 • 198	1.50 • 38.1	1079 • 1606
18-X57-13	CSX 57	4 / 14 AWG 40 / 18 AWG 6 shielded pair / 20 AWG 1 coax / RG6/U	5/32 • 4.0	612 • 187	1.53 • 38.9	1144 • 1702
18-X61-13	CSX 61	7 / 14 AWG 27 / 18 AWG 13 shielded pair / 20 AWG 1 coax / RG6/U	1/4 • 6.4	900 • 275	1.65 • 41.9	1373 • 2043



¹For longer hang length applications, call with your requirements.

^{††}"SP" denotes special color coding and/or conductor numbering.

RG6/U is the standard coaxial cable used in CSX-series Super-Flex cables and the preferred cable for CCTV purposes.

RG11/U coax and multimode optical fiber are available as options.

Super-Flex® Traveling Cable Type ETT/300V

STEEL CENTER – UL LISTED, CSA CERTIFIED, NEC/CEC COMPLIANT – LIFETIME WARRANTY

Power, signal, shielded pairs and coax



Part Number	Product Code	Number/Size of Conductors	Steel Core Dia. inches • mm	Max. Hang Length [†] feet • meters	Cable Nom. OD inches • mm	Cable Net Weight lbs/kft • kg/km
18-X62-13	CSX 62 SP ^{††}	12 / 14 AWG 29 / 18 AWG 10 shielded pair / 20 AWG 1 coax / RG6/U	5/32 • 4.0	525 • 160	1.59 • 40.4	1334 • 1985
18-X69-13	CSX 69	5 / 14 AWG 40 / 18 AWG 11 shielded pair / 20 AWG 2 RG6/U coax	1/4 • 6.4	900 • 275	1.57 • 39.9	1340 • 1994
18-175-13	CSX 75 O	20 / 14 AWG 38 / 18 AWG 8 shielded pair / 20 AWG 1 coax / RG6/U	1/4 • 6.4	900 • 275	1.58 • 40.1	1472 • 2190
18-875-13	CSX 75 T	8 / 14 AWG 54 / 18 AWG 6 shielded pair / 20 AWG 1 RG6/U coax	5/32 • 4.0	542 • 165	1.58 • 40.1	1290 • 1920
18-377-13	CSX 77	4 / 14 AWG 69 / 18 AWG 1 shielded pair / 20 AWG 2 coax / RG6/U	5/32 • 4.0	532 • 162	1.64 • 41.6	1315 • 1957
18-X77-13	CSX 77 S	4 / 14 AWG 60 / 18 AWG 6 shielded pair / 20 AWG 1 coax / RG6/U	1/4 • 6.4	900 • 275	1.52 • 38.6	1269 • 1888
18-X80-13	CSX 80 SP ^{††}	10 / 14 AWG 39 / 18 AWG 15 shielded pair / 20 AWG 1 RG6/U coax	1/4 • 6.4	900 • 275	1.64 • 41.7	1560 • 2321
18-083-13	CSX 83	20 / 14 AWG 35 / 18 AWG 13 shielded pair / 20 AWG 2 coax / RG6/U	1/4 • 6.4	900 • 275	1.92 • 48.8	1808 • 2690



Power, signal, shielded pairs and fiber optics



Part Number	Product Code	Number/Size of Conductors	Steel Core Dia. inches • mm	Max. Hang Length [†] feet • meters	Cable Nom. OD inches • mm	Cable Net Weight lbs/kft • kg/km
18-005-16	CSF 5	3 / 14 AWG 2 optical fibers / 62.5µm	3/32 • 2.4	900 • 275	0.87 • 22.1	370 • 550
18-061-16	CWSF 61	4 / 14 AWG 49 / 18 AWG 3 shielded pair / 20 AWG 2 optical fibers / 62.5µm	1/4 • 6.4	900 • 275	1.36 • 34.5	1125 • 1674
18-062-16	CSF 62	7 / 14 AWG 27 / 18 AWG 13 shielded pair / 20 AWG 2 optical fibers / 62.5µm	1/4 • 6.4	900 • 275	1.58 • 40.0	1296 • 1928



[†]For longer hang length applications, call with your requirements.

^{††}“SP” denotes special color coding and/or conductor numbering.

RG6/U is the standard coaxial cable used in CSX-series Super-Flex cables and the preferred cable for CCTV purposes.

RG11/U coax and multimode optical fiber are available as options.

This catalog shows a sample of product offering. Please call if you require a custom design.



Round Cable Hanging Accessories

FOR JUTE AND STEEL CENTER TRAVELING CABLE INSTALLATION

Universal Hanging System – US patent 5,080,199

Part Number	For Steel Core Dia. inches • mm	Number/ of Cables Held	Max. per cable Load lbs • kg
3/32-1 SBKT	3/32 • 2.4	1 cable	500 • 227
1/8-1 SBKT	1/8 • 3.2	1 cable	500 • 227
5/32-1 SBKT-R	5/32 • 4.0	1 cable	700 • 318
1/4-1 SBKT	1/4 • 6.4	1 cable	1750 • 794

The Universal Hanging System is based around our patented Steel-Core Hanging Device which is designed to solidly grip and support the steel wire support member. It also safely secures the cable to the welded steel bracket thus preventing rotation.

The Universal Hanging System is a safe and effective unit that saves time and labor. It also has the added benefit of not having to bend (and possibly compromise) the steel support as required in other termination methods.

The Universal Hanging System is available in one and two cable configurations and comes as a kit with all installation hardware. Order two kits per cable, one for the car and one for the hoistway.

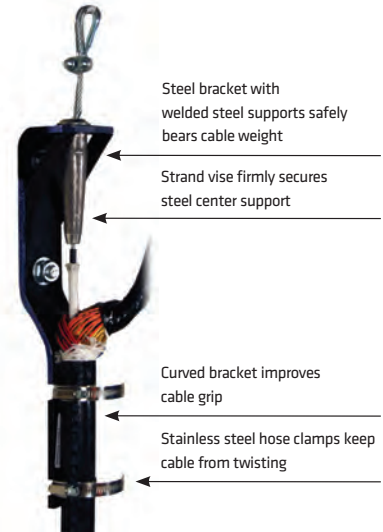

Universal hanging system for two cables

Part Number	For Steel Core Dia. inches • mm	Number/ of Cables Held	Max. per cable Load lbs • kg
5/32-2 SBKT-R	5/32 • 4.0	2 cables	700 • 318
1/4-2 SBKT	1/4 • 6.4	2 cables	1250 • 568

These are two-cable versions of the Universal Hanging System.



Replacement strand vises

Part Number	Description
3/32 PINS-A	Replacement strand vise for 3/32 in. rope
1/8 PINS-A	Replacement strand vise for 1/8 in. rope
5/32 PINS-A	Replacement strand vise for 5/32 in. rope
1/4 PINS-A	Replacement strand vise for 1/4 in. rope

Replacement strand vises are for use ONLY in Universal Hanging Systems in both one and two cable configurations.

Jute core traveling cable hanger for mesh grips

Part Number	Description
HGRJC-8	Bracket used to hold/support grips that hold jute core cables - 8 in. • 20 cm clear between brackets

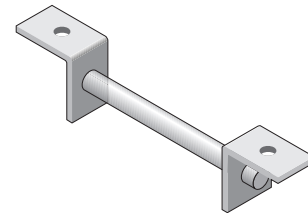

Beam pads

Part Number	Description
22-022	Scotch® 2200 beam pads, 6-1/2 x 4-1/2 x 1/8 in. • 165 x 114 x 6 mm



Mesh Grips

TINNED BRONZE FOR JUTE CENTER TRAVELING CABLES – MAXIMUM HANGING LENGTHS OF 200 FT • 61 M

Single eye / single weave / closed mesh – tinned bronze

Part Number	Cable Dia. Range inches • cm	Maximum Load* lbs • kg	Eye Length inches • mm	Nom. Mesh Length inches • mm
022-01-013	.50 to .62 • 1.27 to 1.57	106 • 48	7.0 • 178	10.0 • 254
022-01-014	.63 to .74 • 1.60 to 1.88	158 • 72	8.0 • 203	10.0 • 254
022-01-015	.75 to .99 • 1.91 to 2.51	204 • 93	8.0 • 203	13.0 • 330
022-01-017	1.00 to 1.24 • 2.54 to 3.15	322 • 146	9.0 • 229	14.0 • 356
022-01-018	1.25 to 1.49 • 3.18 to 3.78	322 • 146	10.0 • 254	15.0 • 381
022-01-019	1.50 to 1.74 • 3.81 to 4.42	322 • 146	12.0 • 305	17.0 • 432
022-01-020	1.75 to 1.99 • 4.45 to 5.05	430 • 195	14.0 • 356	19.0 • 483



Single eye / single weave / split laced – tinned bronze

Part Number	Cable Dia. Range inches • cm	Maximum Load* lbs • kg	Eye Length inches • mm	Nom. Mesh Length inches • mm
022-02-013	.50 to .62 • 1.27 to 1.57	158 • 72	7.0 • 178	10.0 • 254
022-02-014	.63 to .74 • 1.60 to 1.88	158 • 72	8.0 • 203	10.0 • 254
022-02-015	.75 to .99 • 1.91 to 2.51	204 • 93	8.0 • 203	13.0 • 330
022-02-017	1.00 to 1.24 • 2.54 to 3.15	322 • 146	9.0 • 229	14.0 • 355
022-02-018	1.25 to 1.49 • 3.18 to 3.78	322 • 146	10.0 • 254	15.0 • 381
022-02-019	1.50 to 1.74 • 3.81 to 4.42	322 • 146	12.0 • 305	17.0 • 431
022-02-020	1.75 to 1.99 • 4.45 to 5.05	430 • 195	14.0 • 356	16.5 • 419



Single eye / single weave / split rod – tinned bronze

Part Number	Cable Dia. Range inches • cm	Maximum Load* lbs • kg	Eye Length inches • mm	Nom. Mesh Length inches • mm
022-03-061	.37 to .49 • .94 to 1.24	106 • 48	4.0 • 102	5.0 • 127
022-03-013	.50 to .62 • 1.27 to 1.57	106 • 48	7.0 • 178	10.0 • 254
022-03-014	.63 to .74 • 1.60 to 1.88	158 • 72	8.0 • 203	10.0 • 254
022-03-015	.75 to .99 • 1.91 to 2.51	204 • 93	8.0 • 203	13.0 • 330
022-03-017	1.00 to 1.24 • 2.54 to 3.15	322 • 146	9.0 • 229	14.0 • 356
022-03-018	1.25 to 1.49 • 3.18 to 3.78	322 • 146	10.0 • 254	15.0 • 381
022-03-019	1.50 to 1.74 • 3.81 to 4.42	322 • 146	12.0 • 305	17.0 • 432
022-03-020	1.75 to 1.99 • 4.45 to 5.05	430 • 195	14.0 • 356	19.0 • 483



Universal bale / single weave / split rod – tinned bronze

Part Number	Cable Dia. Range inches • cm	Maximum Load* lbs • kg	Eye Length inches • mm	Nom. Mesh Length inches • mm
022-03-066	.75 to .99 • 1.91 to 2.51	204 • 93	up to 16 • 400	10.5 • 267
022-03-068	1.00 to 1.24 • 2.54 to 3.15	322 • 146	up to 16 • 400	12.5 • 317
022-03-069	1.25 to 1.49 • 3.18 to 3.78	322 • 146	up to 16 • 400	14.5 • 368
022-03-070	1.50 to 1.74 • 3.81 to 4.42	322 • 146	up to 16 • 400	15.5 • 394
022-03-071	1.75 to 1.99 • 4.45 to 5.05	430 • 195	up to 16 • 400	16.5 • 419





Mesh Grips

TINNED BRONZE FOR JUTE CENTER TRAVELING CABLES – MAXIMUM HANGING LENGTHS OF 200 FT • 61 M

Double eye / single weave / split laced – tinned bronze

Part Number	Cable Dia. Range inches • cm	Maximum Load* lbs • kg	Eye Length inches • mm	Nom. Mesh Length inches • mm
022-02-002	.63 to .74 • 1.60 to 1.88	170 • 77	4.0 • 102	10.0 • 254
022-02-003	.75 to .99 • 1.91 to 2.51	204 • 93	5.5 • 140	13.0 • 330
022-02-005	1.00 to 1.24 • 2.54 to 3.15	322 • 146	5.0 • 127	14.0 • 356
022-02-006	1.25 to 1.49 • 3.18 to 3.78	322 • 146	5.0 • 127	15.0 • 381
022-02-007	1.50 to 1.74 • 3.81 to 4.42	322 • 146	5.0 • 127	17.0 • 432



Double eye / single weave / split rod – tinned bronze

Part Number	Cable Dia. Range inches • cm	Maximum Load* lbs • kg	Eye Length inches • mm	Nom. Mesh Length inches • mm
022-03-001	.50 to .62 • 1.27 to 1.57	158 • 72	4.0 • 102	6.5 • 165
022-03-002	.63 to .74 • 1.60 to 1.88	158 • 72	4.0 • 102	8.5 • 216
022-03-003	.75 to .99 • 1.91 to 2.51	204 • 93	5.5 • 140	10.5 • 267
022-03-005	1.00 to 1.24 • 2.54 to 3.15	322 • 146	5.0 • 127	12.5 • 317
022-03-006	1.25 to 1.49 • 3.18 to 3.78	322 • 146	5.0 • 127	14.5 • 368
022-03-007	1.50 to 1.74 • 3.81 to 4.42	322 • 146	5.0 • 127	15.5 • 394
022-03-008	1.75 to 1.99 • 4.45 to 5.05	430 • 195	6.0 • 152	16.5 • 419



Double eye / single weave / closed mesh – tinned bronze

Part Number	Cable Dia. Range inches • cm	Maximum Load* lbs • kg	Eye Length inches • mm	Nom. Mesh Length inches • mm
022-01-001	.50 to .62 • 1.27 to 1.57	106 • 48	4.0 • 102	10.0 • 254
022-01-002	.63 to .74 • 1.60 to 1.88	158 • 72	4.0 • 102	10.0 • 254
022-01-003	.75 to .99 • 1.91 to 2.51	204 • 93	5.5 • 140	12.0 • 304
022-01-005	1.00 to 1.24 • 2.54 to 3.15	322 • 146	5.0 • 127	14.0 • 356
022-01-006	1.25 to 1.49 • 3.18 to 3.78	322 • 146	5.0 • 127	15.0 • 381
022-01-007	1.50 to 1.74 • 3.81 to 4.42	322 • 146	5.0 • 127	17.0 • 432
022-01-008	1.75 to 1.99 • 4.45 to 5.05	430 • 195	6.0 • 152	19.0 • 483



*Maximum Load is based on minimum breaking strength with a 4:1 safety factor.

Mesh Grips

STAINLESS STEEL FOR TRAVELING CABLES – MAXIMUM HANGING LENGTHS OF 200 FT • 61 M

Double eye / double weave / split laced – stainless steel

Part Number	Cable Dia. Range inches • cm	Maximum Load* lbs • kg	Eye Length inches • mm	Nom. Mesh Length inches • mm
024-20-1284	.75 to .99 • 1.91 to 2.51	620 • 282	4.0 • 102	13.0 • 330
024-20-1285	1.00 to 1.24 • 2.54 to 3.15	800 • 364	4.0 • 102	14.0 • 356
024-20-1286	1.25 to 1.49 • 3.18 to 3.78	800 • 364	4.0 • 102	15.0 • 381
024-20-1287	1.50 to 1.74 • 3.81 to 4.42	800 • 364	4.0 • 102	17.0 • 432
024-20-1500	1.75 to 2.00 • 4.45 to 5.08	1800 • 818	12.0 • 305	19.0 • 483



Double eye / single weave / split rod – stainless steel

Part Number	Cable Dia. Range inches • cm	Maximum Load* lbs • kg	Eye Length inches • mm	Nom. Mesh Length inches • mm
024-03-005	1.00 to 1.24 • 2.54 to 3.15	530 • 241	5.0 • 127	12.5 • 317
024-03-006	1.25 to 1.49 • 3.18 to 3.78	900 • 409	5.0 • 127	14.5 • 368
024-03-007	1.50 to 1.74 • 3.81 to 4.42	900 • 409	5.0 • 127	15.5 • 394
024-03-008	1.75 to 2.00 • 4.45 to 5.08	1200 • 545	6.0 • 152	16.5 • 419



Double eye / double weave / closed mesh – stainless steel

Part Number	Cable Dia. Range inches • cm	Maximum Load* lbs • kg	Eye Length inches • mm	Nom. Mesh Length inches • mm
024-20-1504	1.00 to 1.24 • 2.54 to 3.15	1200 • 545	12.0 • 305	14.0 • 356
024-20-1470	1.25 to 1.49 • 3.18 to 3.78	1640 • 745	12.0 • 305	15.0 • 381
024-20-1510	1.50 to 1.74 • 3.81 to 4.42	1660 • 755	12.0 • 305	17.0 • 432
024-20-1499	1.75 to 1.99 • 4.45 to 5.05	1800 • 818	12.0 • 305	19.0 • 483
024-20-1542	2.00 to 2.50 • 5.08 to 6.35	1800 • 818	12.0 • 305	21.0 • 533



Single eye / single weave / split rod – stainless steel

Part Number	Cable Dia. Range inches • cm	Maximum Load* lbs • kg	Eye Length inches • mm	Nom. Mesh Length inches • mm
024-03-014	.63 to .74 • 1.60 to 1.88	410 • 186	8.0 • 203	8.5 • 216
024-03-015	.75 to .99 • 1.91 to 2.51	410 • 186	8.0 • 203	10.5 • 267
024-03-017	1.00 to 1.24 • 2.54 to 3.15	530 • 240	9.0 • 229	12.5 • 317
024-03-018	1.25 to 1.49 • 3.18 to 3.78	900 • 408	10.0 • 254	14.5 • 368
024-03-019	1.50 to 1.74 • 3.81 to 4.42	900 • 408	12.0 • 305	15.5 • 394



Universal bale / single weave / split rod – stainless steel

Part Number	Cable Dia. Range inches • cm	Maximum Load* lbs • kg	Eye Length inches • mm	Nom. Mesh Length inches • mm
024-03-066	.75 to .99 • 1.91 to 2.51	336 • 153	up to 16 • 400	10.5 • 267
024-03-068	1.00 to 1.24 • 2.54 to 3.15	530 • 241	up to 16 • 400	12.5 • 317
024-03-069	1.25 to 1.49 • 3.18 to 3.78	530 • 241	up to 16 • 400	14.5 • 368
024-03-070	1.50 to 1.74 • 3.81 to 4.42	530 • 241	up to 16 • 400	15.5 • 394



*Maximum Load is based on minimum breaking strength with a 4:1 safety factor.



Flat Traveling Cable Type ETP/300V

UNSUPPORTED – UL LISTED, CSA CERTIFIED, NEC/CEC COMPLIANT

Power and signal conductors



Part Number	Product Code	Number/Size of Conductors	Max. Hang Length feet • meters	Cable Nom. Dim H x W inches • mm	Cable Net Weight lbs/kft • kg/km
18-008-07	P 8-18	8 / 18 AWG	200 • 61	.19 x 1.00 • 4.8 x 25.4	145 • 215
18-009-07	P 9-18	9 / 18 AWG	200 • 61	.19 x 1.01 • 4.8 x 25.6	137 • 203
18-010-07	P 10-18	10 / 18 AWG	200 • 61	.19 x 1.07 • 4.8 x 27.2	157 • 233
18-012-07	P 12-18	12 / 18 AWG	200 • 61	.19 x 1.30 • 4.8 x 33.0	210 • 312
18-016-07	P 16-18	16 / 18 AWG	200 • 61	.19 x 1.67 • 4.8 x 42.4	235 • 349
18-020-07	P 20-18	20 / 18 AWG	200 • 61	.19 x 2.30 • 4.8 x 58.4	296 • 440
18-208-07	P 8-16	8 / 16 AWG	200 • 61	.20 x 0.97 • 5.1 x 24.6	156 • 232
18-212-07	P 12-16	12 / 16 AWG	200 • 61	.20 x 1.50 • 5.1 x 38.1	231 • 343
18-224-07	P 24-16	16 / 16 AWG	200 • 61	.20 x 2.90 • 5.1 x 73.7	462 • 686
18-412-07	P 12-14	12 / 14 AWG	200 • 61	.26 x 2.00 • 6.6 x 50.8	366 • 543



Shielded pairs



Part Number	Product Code	Number/Size of Conductors	Max. Hang Length feet • meters	Cable Nom. Dim H x W inches • mm	Cable Net Weight lbs/kft • kg/km
18-X04-07	P 4X20SH	4 shielded pair / 20 AWG	200 • 61	.30 x .940 • 7.62 x 23.9	184 • 273
18-X08-07	P 8X20SH	8 shielded pair / 20 AWG	200 • 61	.30 x 2.00 • 7.62 x 50.8	430 • 638



Unitized conductors / power and signal conductors



Part Number	Product Code	Number/Size* of Conductors	Max. Hang Length feet • meters	Cable Nom. Dim H x W inches • mm	Cable Net Weight lbs/kft • kg/km
18-040-07	G 40-18 UNITIZED	40 / 18 AWG	200 • 61	.39 x 1.90 • 9.9 x 48.3	524 • 778
18-C28-07	GCX 31	28 / 18 AWG 3 RG6/U coax	200 • 61	.375 x 2.20 • 9.5 x 55.9	565 • 839



Note: European standards limit maximum hang lengths to 45 meters for unsupported cables.

Use these tools to prepare Super-Flex traveling cable.

#36-135-M1
FCJ flat cable stripper



#17-05-0001
QuickStrip wire stripper



#36-219 Automatic
wire stripper



#37-177 Manual
wire stripper



This catalog shows a sample of product offering. Please call if you require a custom design.

Flat Traveling Cable Type ETP/300V

UNSUPPORTED – UL LISTED, CSA CERTIFIED, NEC/CEC COMPLIANT

Power and signal conductors



Part Number	Product Code	Number/Size of Conductors	Max. Hang Length feet • meters	Cable Nom. Dim H x W inches • mm	Cable Net Weight lbs/kft • kg/km
18-X11-07	PC11	3 / 14 AWG 4 shielded pair / 20 AWG	200 • 61	.29 x 1.55 • 7.4 x 39.4	345 • 512
18-216-07	PC16	2 / 14 AWG 1 shielded pair / 14 AWG 6 shielded pair / 18 AWG	200 • 61	.43 x 2.40 • 10.9 x 61.0	690 • 1024
18-A16-07	PC16A	4 / 14 AWG 10 / 18 AWG 1 shielded pair / 20 AWG	200 • 61	.29 x 2.20 • 7.4 x 55.9	490 • 728
18-C16-07	PC16	4 / 14 AWG 12 / 18 AWG	200 • 61	.23 x 1.91 • 5.8 x 48.5	385 • 572
18-C18-07	PC 18	6 / 14 AWG 12 / 18 AWG	200 • 61	.23 x 2.19 • 5.8 x 55.6	401 • 597
18-218-07	PC 18	2 / 14 AWG 12 / 18 AWG 2 twisted pair / 20 AWG 2 shielded pair / 20 AWG	200 • 61	.23 x 1.20 • 5.8 x 30.5	330 • 490
18-021-07	PC21	3 / 14 AWG 14 / 18 AWG 2 shielded pair / 20 AWG	200 • 61	.29 x 2.35 • 7.4 x 59.7	499 • 741
18-C21-07	PCX21	4 / 14 AWG 10 / 18 AWG 3 shielded pair / 20 AWG 1 RG6/U coax	200 • 61	.375 x 2.80 • 9.5 x 71.1	715 • 1062
18-421-07	PC21 SP [†]	5 / 16 AWG 8 / 18 AWG 4 twisted pair / 20 AWG	200 • 61	.29 x 2.33 • 7.4 x 59.2	494 • 733
18-X22-07	PC22	4 / 14 AWG 10 / 18 AWG 4 shielded pair / 20 AWG	200 • 61	.29 x 2.65 • 7.4 x 67.3	639 • 935
18-026-07	PC26 SP [†]	4 / 14 AWG 10 / 18 AWG 6 foil shielded pair / 20 AWG	200 • 61	.25 x 2.74 • 6.4 x 69.6	525 • 780
18-X26-07	PC 26	4 / 14 AWG 10 / 18 AWG 6 shielded pair / 20 AWG	200 • 61	.29 x 3.05 • 7.4 x 77.5	626 • 932



[†]“SP” denotes special color coding and/or conductor numbering.

Note: European standards limit maximum hang lengths to 45 meters for unsupported cables.



Flat Traveling Cable Type ETP/300V

SUPPORTED - UL LISTED, CSA CERTIFIED, NEC/CEC COMPLIANT

Power and signal conductors



Part Number	Product Code	Number/Size of Conductors	Steel Support Dia. inches • mm	Max. Hang Length feet • meters	Cable Nom. Dim H x W inches • mm	Cable Net Weight lbs/kft • kg/km
18-012-17	PWS 12-14	12 / 14 AWG	3/32 • 2.4	900 • 274	.24 x 2.20 • 6.1 x 56.0	444 • 659
18-020-17	PWS 20-18	20 / 18 AWG	3/32 • 2.4	900 • 274	.19 x 2.30 • 4.8 x 58.4	348 • 517
18-024-17	PWS 24-18	24 / 18 AWG	3/32 • 2.4	900 • 274	.19 x 2.69 • 4.8 x 68.3	407 • 604
18-C13-17	PWS13	4 / 14 AWG 4 shielded pair / 20 AWG 1 RG6/U coax	3/32 • 2.4	700 • 213	.38 x 2.25 • 9.5 x 57.0	590 • 876
18-C17-17	PCSX17	8 shielded pair / 20 AWG 1 RG6 coax	3/32 • 2.4	672 • 205	.38 x 2.35 • 9.5 x 60.0	616 • 915
18-C26-17	PCWS26	18 / 18 AWG 4 shielded pair / 20 AWG	3/32 • 2.4	638 • 194	.29 x 3.00 • 7.4 x 76.0	648 • 962
18-F09-17	PCWSF9	4 shielded pair / 20 AWG 1 optical fiber (62.5/125µm)	3/32 • 2.4	900 • 274	.29 x 1.50 • 7.4 x 38.0	302 • 448
18-X20-17	PCSX20	2 / 16 AWG 8 shielded pair / 20 AWG 2 RG6/U coax	3/32 • 2.4	457 • 139	.38 x 3.00 • 9.5 x 76.0	905 • 1344
18-X26-17	PCWS26	4 / 14 AWG 10 / 18 AWG 6 shielded pair / 20 AWG	3/32 • 2.4	560 • 171	.29 x 3.25 • 7.4 x 82.6	739 • 1097



Unitized construction / power and signal conductors



Part Number	Product Code	Number/Size of Conductors	Steel Support Dia. inches • mm	Max. Hang Length feet • meters	Cable Nom. Dim H x W inches • mm	Cable Net Weight lbs/kft • kg/km
18-039-17	GCWS39	6 / 14 AWG 33 / 18 AWG	3/32 • 2.4	573 • 175	.41 x 2.50 • 10.4 x 63.5	722 • 1072
18-040-17	GWS 40-18 UNITIZED	40 / 18 AWG	1/8 • 3.2	900 • 274	.39 x 2.20 • 10.0 x 56.0	646 • 959



Use these tools to prepare Super-Flex traveling cable.

#36-135-M1
FCJ flat cable stripper



#17-05-0001
QuickStrip wire stripper



#36-219 Automatic
wire stripper



#37-177 Manual
wire stripper



This catalog shows a sample of product offering. Please call if you require a custom design.

Flat Cable Suspension Devices

FOR UNSUPPORTED FLAT CABLES – NYLON/PLASTIC CONSTRUCTION

Suspension device – nylon/plastic

Part Number	Description
FCSD-2	Flat cable suspension device for cables up to 2 in • 51 mm wide Mounting holes are .20 in. • 5 mm with .55 in. • 14 mm counterbore

The FCSD-2 is made of a durable nylon/plastic. It consists of a bracket that attaches to the hoistway wall or the car, and a clamping wedge that secures the cable in the bracket.

The FCSD-2 is designed to hold cables totaling a maximum thickness of 0.47 in. • 12 mm and maximum width of 2 inches • 52 mm. If multiple cables are being supported, the narrowest width cable must not be less than 70% of the width of the widest cable.

Order two devices per cable, one for the car and one for the hoistway.

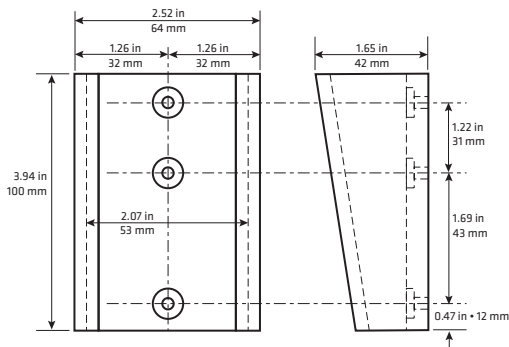

Suspension device – nylon/plastic

Part Number	Description
FCSD-3	Flat cable suspension device for one or more cables up to 3 in • 76 mm wide Mounting holes are .25 in. • 6.35 mm with .55 in. • 14 mm counterbore

The FCSD-3 is made of a durable nylon/plastic. It consists of a bracket that attaches to the hoistway wall or the car, and a clamping wedge that secures the cable in the bracket.

The FCSD-3 is designed to hold one or more cables totaling a maximum thickness of 0.59 in. • 15 mm and maximum width of 3 in. • 76 mm. If multiple cables are being supported, the narrowest width cable must not be less than 70% of the width of the widest cable.

Order two devices per cable, one for the car and one for the hoistway.

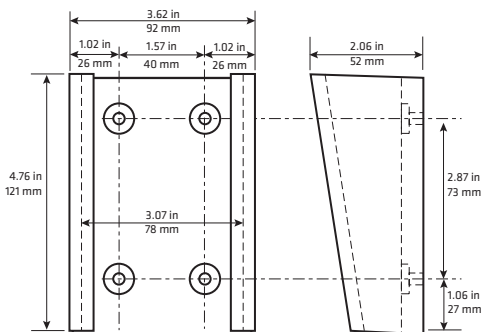



Flat Cable Suspension Devices

FOR UNSUPPORTED FLAT CABLES – NYLON/PLASTIC OR STEEL CONSTRUCTION

Wide suspension device – nylon/plastic

Part Number	Description
FCSD-4P	Flat cable suspension device for one or more cables, max 4.5 in • 114 mm wide Mounting holes are .26 in. • 6.6 mm with 0.66 in • 17 mm counterbore

The FCSD-4P is made of a durable nylon/plastic. It consists of a bracket that attaches to the hoistway wall or the car, and a clamping wedge that secures the cable in the bracket.

The FCSD-4P is designed to hold one or more cables up to a maximum thickness of 0.59 in. • 15 mm and maximum width of 4.5 in. • 114 mm.

Order two devices per cable, one for the car and one for the hoistway.

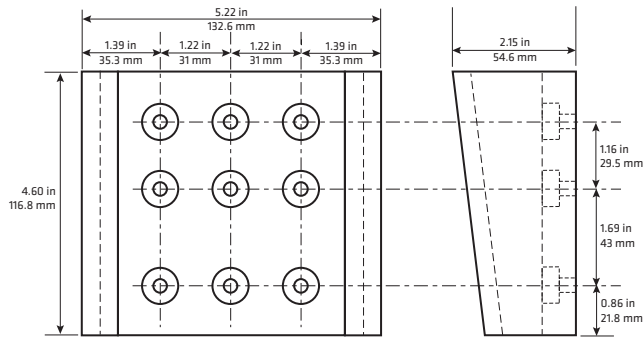

Wide suspension device – steel

Part Number	Description
FCSD-4	Flat cable suspension device for up to 3 cables, max 4 in • 101 mm wide Mounting holes are .281 in. • 7.14 mm

The FCSD-4 is formed of sheet steel with an aluminum clamping wedge. The bracket attaches to the hoistway wall or the car, and the clamping wedge secures the cable in the bracket.

The FCSD-4 is designed to hold up to three cables totaling a maximum thickness of .55 inches • 14 mm and a maximum width of 4 in. • 101 mm. Maximum load is 500 lbs • 227 kg. If multiple cables are being supported, the narrowest width cable must not be less than 70% of the width of the widest cable.

Order two devices per cable, one for the car and one for the hoistway.

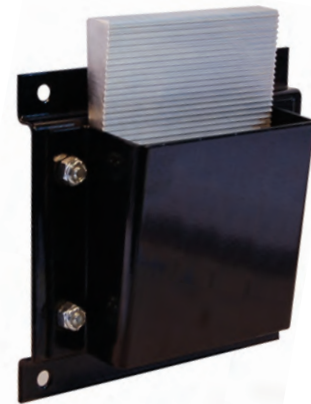
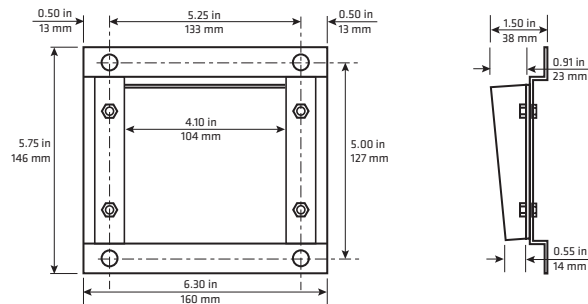

Flat Cable Suspension Devices

FOR STEEL-SUPPORTED FLAT CABLES – STEEL CONSTRUCTION

Steel-supported suspension device – steel

Part Number	Description
FCSD-S	Flat cable suspension device for steel supported cables. Mounting holes are 1/2 in. • 12.7 mm

The FCSD-S is formed of sheet steel. It attaches to the hoistway wall or the car. The steel support cable is carried by the four 3/8 in. • 9.5 mm carbon-steel support studs, and held in place by the front bracket.

The FCSD-S is designed to hold multiple cables up to 4.1 in. • 105 mm in width totaling a maximum thickness of 5/8 in. • 16 mm. Maximum supported weight is 1500 lbs • 681 kg.

Order two devices per cable, one for the car and one for the hoistway.

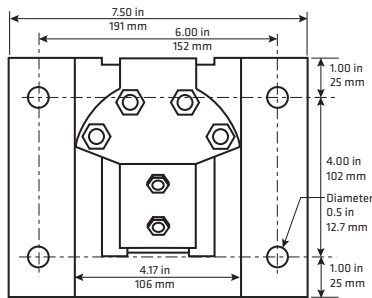



Super-Duct® Hoistway Cable/600V

JACKETED AND UNJACKETED – UL LISTED, CSA CERTIFIED, NEC/CEC COMPLIANT

Unjacketed – power and signal conductors



Part Number	Product Code	Number/Size of Conductors	Cable Nom. OD inches • mm	Cable Net Weight lbs/kft • kg/km
18-003-41	WOJ 3-14	3 / 14 AWG	0.31 • 7.9	59 • 88
18-604-47	WOJ 4-14	4 / 14 AWG (insulation colors are red, white, black and green)	0.35 • 9.0	79 • 118
18-005-47	WOJ 5-14	5 / 14 AWG (insulation colors are one black, four grey - special print numbers)	0.40 • 10.2	102 • 152
18-008-47	WOJ 8-14 SP [†]	8 / 14 AWG (Conductors colors are #1 / green, #2 to 4 / white, #5 to 8 / black)	0.50 • 12.7	158 • 235
18-218-47	WOJ 2X18TW 600V SP [†]	2 unshielded pair / 18 AWG	0.36 • 9.2	41 • 61
18-014-41	WOJ 14-14	14 / 14 AWG	0.63 • 16.0	276 • 411
18-404-41	WOJ 4-18	4 / 18 AWG	0.27 • 6.9	41 • 61
18-404-47	WOJ 4-18 SP [†]	4 / 18 AWG (conductors colors are #1 / yellow, #2 / orange, #3 / blue, #4 / red)	0.27 • 6.9	41 • 61
18-407-41	WOJ 7-18	7 / 18 AWG	0.34 • 8.6	72 • 107
18-408-48	WOJ 8-18	8 / 18 AWG (available with only 90°C-rated conductors)	0.35 • 8.9	80 • 119
18-410-41	WOJ 10-18	10 / 18 AWG	0.43 • 10.9	103 • 153
18-412-41	WOJ 12-18	12 / 18 AWG	0.46 • 11.7	119 • 177
18-414-41	WOJ 14-18	14 / 18 AWG	0.49 • 12.4	144 • 214
18-416-41	WOJ 16-18	16 / 18 AWG	0.53 • 13.5	165 • 246
18-419-41	WOJ 19-18	19 / 18 AWG	0.56 • 14.2	195 • 290
18-424-41	WOJ 24-18	24 / 18 AWG	0.66 • 16.8	234 • 349
18-430-41	WOJ 30-18	30 / 18 AWG	0.72 • 18.3	307 • 457
18-437-41	WOJ 37-18	37 / 18 AWG	0.78 • 19.8	380 • 566
18-437-47	WOJ 37-18 SP [†]	37 / 18 AWG (conductors are numbered 38 to 74)	0.78 • 19.8	380 • 566
18-442-41	WOJ 42-18	42 / 18 AWG	0.84 • 21.3	432 • 643
18-461-41	WOJ 61-18	61 / 18 AWG	0.98 • 24.9	625 • 930



Jacketed – power and signal conductors



Part Number	Product Code	Number/Size of Conductors	Cable Nom. OD inches • mm	Cable Net Weight lbs/kft • kg/km
18-404-43	D4-18	4 / 18 AWG (conductor colors are #1/black - #2/white - #3/green - #4/red)	0.33 • 8.4	58 • 86
18-007-45	D 7-14	7 / 14 AWG (conductors are solid, not stranded, copper)	0.46 • 11.7	151 • 225
18-407-43	D7-18	7 / 18 AWG	0.40 • 10.2	91 • 135

90° C-rated conductors are available upon request.

[†]"SP" denotes special color coding and/or conductor numbering.



Use these tools to prepare Super-Duct hoistway cable.

#17-05-0001
QuickStrip wire stripper

#36-219 Automatic
wire stripper

#37-177 Manual
wire stripper



This catalog shows a sample of product offering. Please call if you require a custom design.

Super-Duct® Hoistway Cable/300V and 600V

UNJACKETED - UL LISTED, CSA CERTIFIED, NEC/CEC COMPLIANT

Unjacketed - power and signal conductors / 300V



Part Number	Product Code	Number/Size of Conductors	Cable Nom. OD inches • mm	Cable Net Weight lbs/kft • kg/km
18-704-41	WOJ 4-18 300V	4 / 18 AWG	0.22 • 5.6	32 • 48
18-705-41	WOJ 5-18 300V	5 / 18 AWG	0.25 • 6.4	41 • 61
18-707-41	WOJ 7-18 300V	7 / 18 AWG	0.27 • 6.9	57 • 85
18-710-41	WOJ 10-18 300V	10 / 18 AWG	0.34 • 8.6	81 • 121
18-714-41	WOJ 14-18 300V	14 / 18 AWG	0.40 • 10.2	114 • 170
18-716-41	WOJ 16-18 300V	16 / 18 AWG	0.43 • 10.9	130 • 194
18-719-41	WOJ 19-18 300V	19 / 18 AWG	0.45 • 11.4	155 • 231
18-730-41	WOJ 30-18 300V	30 / 18 AWG	0.58 • 14.7	246 • 367
18-737-41	WOJ 37-18 300V	37 / 18 AWG	0.63 • 16.0	301 • 449
18-761-41	WOJ 61-18 300V	61 / 18 AWG	0.82 • 20.8	503 • 750
18-102-47	WOJ 1x18 O/GY 300V	1 unshielded pair / 18 AWG	0.18 • 4.6	16 • 24
18-202-47	WOJ 1x18 R/BK 300V	1 unshielded pair / 18 AWG	0.18 • 4.6	16 • 24
18-104-47	WOJ 2x18 DUCT SP 300V†	2 unshielded pairs / 18 AWG	0.30 • 7.6	33 • 49



Unjacketed - power, signal, shielded pairs and coax / 300V and 600V



Part Number	Product Code	Number/Size of Conductors	Cable Nom. OD inches • mm	Cable Net Weight lbs/kft • kg/km	Rated Voltage
18-311-42	CWOJ 14 SP†	3 / 14 AWG 11 / 18 AWG (conductor colors are #12/black - #13/white - #14/green)	0.48 • 12.2	148 • 221	300V
18-305-56	3-14+1X18 600V	3 / 14 AWG 1 unshielded pair / 18 AWG	0.49 • 12.4	80 • 120	600V
18-130-42	CWOJ 30 SP†	13 / 14 AWG 17 / 18 AWG	0.85 • 21.6	436 • 647	600V
18-032-47	CWOJ 32 SP†	6 / 14 AWG 16 / 18 AWG 1 shielded pair / 20 AWG 1 unshielded pair / 20 AWG 3 unshielded pair / 18 AWG	0.85 • 21.6	401 • 597	600V
18-449-42	CWOJ 49	4 / 14 AWG 45 / 18 AWG	0.98 • 24.9	530 • 789	600V
18-57X-42	CWOJ 57	4 / 14 AWG 40 / 18 AWG 6 shielded pair / 20 AWG 1 coax / RG6/U	1.13 • 28.7	612 • 913	300V
18-661-42	CWOJ 71	6 / 14 AWG 61 / 18 AWG 2 shielded pair / 20 AWG	1.18 • 30.0	816 • 1214	600V
18-X77-42	CWOJ 77	4 / 14 AWG 60 / 18 AWG 6 shielded pair / 20 AWG 1 coax / RG6/U	1.22 • 31.0	831 • 1237	600V

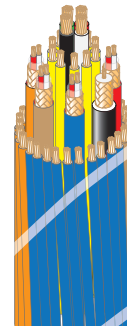

†"SP" denotes special color coding and/or conductor numbering
90° C-rated conductors are available upon request.

Use these tools to prepare Super-Duct hoistway cable.

- #17-05-0001 QuickStrip wire stripper
- #36-219 Automatic wire stripper
- #37-177 Manual wire stripper



This catalog shows a sample of product offering. Please call if you require a custom design.



Stationary Cable and Door Lock Wire

UL LISTED, CSA CERTIFIED, NEC/CEC COMPLIANT - OTHER COMPLIANCE AS NOTED

Stationary shielded pair cable for audio / data communications



Part Number	Number/Size of Conductors	Shielded Pair Colors	Shield Type and Coverage	Drain Wire	Nominal OD inches • mm	Net Weight lbs/kft • kg/km
18-801-43	1 shielded pair / 20 AWG	red/white	Copper braid 85%	-	0.22 • 5.5	29 • 43
M13142	2 shielded pair / 20 AWG	black/red, green/white	Foil 100%	22 AWG	0.23 • 5.8	34 • 51
M13143	3 shielded pair / 20 AWG	see below	Foil 100%	22 AWG	0.30 • 7.6	52 • 77
M13144	4 shielded pair / 20 AWG	see below	Foil 100%	22 AWG	0.32 • 8.1	64 • 95
M13146	6 shielded pair / 20 AWG	see below	Foil 100%	22 AWG	0.38 • 9.7	87 • 130
M13149	9 shielded pair / 20 AWG	see below	Foil 100%	22 AWG	0.45 • 11.4	132 • 196
M13152	12 shielded pair / 20 AWG	see below	Foil 100%	22 AWG	0.50 • 12.7	169 • 251
M13155	15 shielded pair / 20 AWG	see below	Foil 100%	22 AWG	0.60 • 15.2	225 • 335

Single pair cable has a black jacket.
Multiple pair cables have grey jackets.

- pair #1 - black/red
- pair #2 - black/white
- pair #3 - black/green
- pair #4 - black/blue
- pair #5 - black/yellow
- pair #6 - black/brown
- pair #7 - black/orange
- pair #8 - red/white
- pair #9 - red/green
- pair #10 - red/blue
- pair #11 - red/yellow
- pair #12 - red/brown
- pair #13 - red/orange
- pair #14 - green/white
- pair #15 - green/blue



Door Lock Wire SF-2 single conductor / 600V 200° C rated

NYC code compliant / complies with ANSI/ASTM B174 and B3 as required



Part Number	Product Code	Description/Size of Single Conductor	Nominal OD inches • mm	Net Weight lbs/kft • kg/km	Put-ups	Jacket Color
16ASF2BLAT	16 AWG SF-2	7 / .019 tinned copper 16 AWG	0.14 • 3.6	15 • 22.3	cut to length	Black
16ASF2RDAT	16 AWG SF-2	as above	0.14 • 3.6	15 • 22.3	cut to length	Red
16ASF2WR500	16 AWG SF-2	as above	0.14 • 3.6	15 • 22.3	500 ft.	White/Red
16ASF2WRAT	16 AWG SF-2	as above	0.14 • 3.6	15 • 22.3	cut to length	White/Red
18ASF2RD1000	18 AWG SF-2	7 / .015 tinned copper 18 AWG	0.13 • 3.3	12 • 17.9	1000 ft.	Red
18ASF2RD500	18 AWG SF-2	as above	0.13 • 3.3	12 • 17.9	500 ft.	Red
18ASF2RDAT	18 AWG SF-2	as above	0.13 • 3.3	12 • 17.9	cut to length	Red
18ASF2WR1000	18 AWG SF-2	7 / .015 tinned copper 18 AWG	0.13 • 3.3	12 • 17.9	1000 ft.	White/Red
18ASF2WR500	18 AWG SF-2	as above	0.13 • 3.3	12 • 17.9	500 ft.	White/Red
18ASF2WRAT	18 AWG SF-2	as above	0.13 • 3.3	12 • 17.9	cut to length	White/Red
18SSF2RDAT	18 AWG SF-2	Solid tinned copper 18 AWG	0.12 • 3.0	12 • 17.9	cut to length	Red



Use these tools to prepare wire and cable.

#17-05-0001
QuickStrip wire stripper

#36-219 Automatic
wire stripper

#37-177 Manual
wire stripper



Hook-up Wire (THHN) 600V 90°C Rated

UL LISTED, CSA CERTIFIED, NEC/CEC COMPLIANT

THHN-type single conductor



Part Number	Product Code	Description/Size of Single Conductor	Nominal OD inches • mm	Net Weight lbs/kft • kg/km	Insulation Thickness inches • mm	Insulation Color
4/0ATHHNBL	4/0 THHN	19 strand copper 4/0 AWG	0.64 • 16.2	711 • 1058	.05 • 1.3	Black
3/0ATHHNBL	3/0 THHN	19 strand copper 3/0 AWG	0.58 • 14.7	570 • 848	.05 • 1.3	Black
2/0ATHHNBL	2/0 THHN	19 strand copper 2/0 AWG	0.52 • 13.2	458 • 681	.05 • 1.3	Black
1/0ATHHNBL	1/0 THHN	19 strand copper 1/0 AWG	0.48 • 12.2	369 • 549	.05 • 1.3	Black
1ATHHNBL	1 AWG THHN	19 strand copper 1 AWG	0.44 • 11.2	297 • 442	.05 • 1.3	Black
2ATHHNBL	2 AWG THHN	19 strand copper 2 AWG	0.38 • 9.7	232 • 345	.04 • 1.0	Black
4ATHHNBL	4 AWG THHN	19 strand copper 4 AWG	0.32 • 8.1	151 • 225	.04 • 1.0	Black
6ATHHNBL	6 AWG THHN	19 strand copper 6 AWG	0.25 • 6.4	94 • 140	.03 • 0.8	Black
6ATHHNGN	6 AWG THHN	19 strand copper 6 AWG (also suitable for 105° C AWM)	0.25 • 6.4	94 • 140	.03 • 0.8	Green
8ATHHNBL	8 AWG THHN	19 strand copper 8 AWG	0.22 • 5.5	62 • 92	.03 • 0.8	Black
8ATHHNGN	8 AWG THHN	19 strand copper 8 AWG (also suitable for 105° C AWM)	0.22 • 5.5	62 • 92	.03 • 0.8	Green
10ATHHNBL	10 AWG THHN	19 strand copper 10 AWG	0.16 • 4.0	38 • 57	.02 • 0.5	Black
10ATHHNGN	10 AWG THHN	19 strand copper 10 AWG (also suitable for 105° C AWM)	0.16 • 4.0	38 • 57	.02 • 0.5	Green
12ATHHNBL	12 AWG THHN	19 strand copper 12 AWG	0.13 • 3.3	24 • 36	.02 • 0.5	Black
12ATHHNGN	12 AWG THHN	19 strand copper 12 AWG (also suitable for 105° C AWM)	0.13 • 3.3	24 • 36	.02 • 0.5	Green



THHN (or MTW or THWN-2) conductors are suitable for operations at 600 volts as specified in the National Electrical Code, at conductor temperatures not to exceed 75° C when exposed to oil or coolant, 90° C in wet or dry locations.

All cables are cut to length. Please specify.

Use these tools to prepare wire and cable.

#17-05-0001
QuickStrip wire stripper

#36-219 Automatic
wire stripper

#37-177 Manual
wire stripper





Hook-up Wire (TEW) 600V 105°C Rated

UL LISTED, CSA CERTIFIED, NEC/CEC COMPLIANT

TEW-type single conductor



Part Number	Product Code	Description/Size of Single Conductor	Nominal OD inches • mm	Net Weight lbs/kft • kg/km	Length on Reel	Insulation Color
14ATEWBU500	14 AWG TEW	19 / .0147 strand copper 14 AWG	0.13 • 3.3	19 • 28.1	500 ft.	Blue
14ATEWBL500	14 AWG TEW	as above	0.13 • 3.3	19 • 28.1	500 ft.	Black
14ATEWGN500	14 AWG TEW	as above	0.13 • 3.3	19 • 28.1	500 ft.	Green
14ATEWRD500	14 AWG TEW	as above	0.13 • 3.3	19 • 28.1	500 ft.	Red
14ATEWWH500	14 AWG TEW	as above	0.13 • 3.3	19 • 28.1	500 ft.	White
16ATEWBL500	16 AWG TEW	26 / .010 strand copper 16 AWG	0.12 • 3.0	15 • 22.2	500 ft.	Black
16ATEWBU500	16 AWG TEW	as above	0.12 • 3.0	15 • 22.2	500 ft.	Blue
16ATEWOR500	16 AWG TEW	as above	0.12 • 3.0	15 • 22.2	500 ft.	Orange
16ATEWYW500	16 AWG TEW	as above	0.12 • 3.0	15 • 22.2	500 ft.	Yellow
18ATEWBL500	18 AWG TEW	16 / .010 strand copper 18 AWG	0.11 • 2.8	11 • 16.3	500 ft.	Black
18ATEWBR500	18 AWG TEW	as above	0.11 • 2.8	11 • 16.3	500 ft.	Brown
18ATEWBU500	18 AWG TEW	as above	0.11 • 2.8	11 • 16.3	500 ft.	Blue
18ATEWGN500	18 AWG TEW	as above	0.11 • 2.8	11 • 16.3	500 ft.	Green
18ATEWGY500	18 AWG TEW	as above	0.11 • 2.8	11 • 16.3	500 ft.	Grey
18ATEWMR500	18 AWG TEW	as above	0.11 • 2.8	11 • 16.3	500 ft.	Maroon
18ATEWOR500	18 AWG TEW	as above	0.11 • 2.8	11 • 16.3	500 ft.	Orange
18ATEWPK500	18 AWG TEW	as above	0.11 • 2.8	11 • 16.3	500 ft.	Pink
18ATEWPU500	18 AWG TEW	as above	0.11 • 2.8	11 • 16.3	500 ft.	Purple
18ATEWRD500	18 AWG TEW	as above	0.11 • 2.8	11 • 16.3	500 ft.	Red
18ATEWTN500	18 AWG TEW	as above	0.11 • 2.8	11 • 16.3	500 ft.	Tan
18ATEWYW500	18 AWG TEW	as above	0.11 • 2.8	11 • 16.3	500 ft.	Yellow
20ATEWBL	20 AWG TEW	10 / .030 strand copper 20 AWG	0.10 • 2.5	8 • 3.6	1000 ft.	Black
20ATEWRD	20 AWG TEW	as above	0.10 • 2.5	8 • 3.6	1000 ft.	Red
20ATEWWH	20 AWG TEW	as above	0.10 • 2.5	8 • 3.6	1000 ft.	White



Use these tools to prepare wire and cable.

#17-05-0001
QuickStrip wire stripper

#36-219 Automatic
wire stripper

#37-177 Manual
wire stripper



Power, Signal and Communication Cable

UL LISTED, CSA CERTIFIED, NEC/CEC COMPLIANT

500W-type four conductor portable cord / 600V 90°C rated



Part Number	Product Code	Description/Size of Conductors	Nominal OD inches • mm	Net Weight lbs./kft • kg/km	Put-ups	Jacket Colors
6/4 500W	6 AWG 500W	133 / .0142 strand copper	1.06 • 26.9	856 • 388	250 ft.	Black
8/4 500W	8 AWG 500W	65 / .0159 strand copper	0.93 • 23.6	605 • 274	250 ft.	Black
10/4 500W	10 AWG 500W	104 / .010 strand copper	0.70 • 17.8	357 • 162	250 ft.	Black

Other gauge sizes and conductor counts are available with short lead times.

Control and signal or power cable for hoistway and machine room



Part Number	Description	Suggested Use
TR-64	7 / 18 AWG stranded copper, PVC insulation, unjacketed, 300V 90° C	Control and signal

Data communications cable for hoistway and machine room



Part Number	Description	Suggested Use
5508	Cat 5e UTP / 24 AWG stranded tin copper, unshielded, grey PVC jacket, 75° C (sold on 1000 ft. reels)	Data communications
1PR#18SHDJK	1 shielded twisted pair / 18 AWG stranded copper, PVC jacket, foil shield, 600V 60° C	Control and signal
W#UL-2464	2 shielded twisted pairs / 18 AWG stranded copper, PVC jacket, individual foil shield, 300V 80° C	Control and signal
9369	3 shielded twisted pairs / 18 AWG stranded copper, PVC jacket, individual foil shield, 300V 105° C (sold on 1000 ft. reels)	Instrumentation
9830	3 pairs / 24 AWG stranded tin/copper, PVC insulation, foil and braid shields, PVC jacket, 300V 80° C (sold on 1000 ft. reels)	Data communications
3105A	1 pair / 22 AWG stranded tin copper, 120 ohm • overall foil shield, PVC jacket, 300V 60° C	Data communications

Coax cable for hoistway and machine room



Part Number	Description	Suggested Use
9259	RG59/U coax with a stranded copper conductor, PVC jacket	Video, CCTV
9244	RG59/U coax with a solid copper conductor, PVC jacket	Video, CCTV
9475	RG6/U coax with a stranded copper conductor, PVC jacket	Video, CCTV

Instrumentation cable for hoistway and machine room



Part Number	Description	Suggested Use
9512	2 pair / 22 AWG stranded tin/copper, PVC insulation, overall foil shield, PVC jacket, 300V 105° C	Instrumentation
9514	4 pair / 22 AWG stranded tin/copper, PVC insulation, overall foil shield, PVC jacket, 300V 105° C	Instrumentation

Power cable for hoistway and machine room



Part Number	Description	Suggested Use
1PR#18ATEW-TW	1 twisted pair / 18 AWG stranded copper, unjacketed, orange/black, 600V 105° C	Power
1PR#12TW	1 twisted pair / 12 AWG stranded copper, unjacketed, red/black, 600V 105° C	Power

Fiber optic cable for communications and video

Part Number	Description	Suggested Use
400-00-SF-006	Tight buffered OM3 50 µm multimode fiber, 850/1300 wavelength with 1500/500 MHz bandwidth, 1 GbE performance at 1000 meters, 10 GbE performance at 300 meters	Video and data communications



Rails, Ferrules and Connectors

UL LISTED, CSA CERTIFIED

Carrier rails



Part Number	Description
210-113	DIN 35 rail, steel/unslotted, 6.6 ft • 2 meters long
210-112	DIN 35 rail, steel/slotted, 6.6 ft • 2 meters long
210-111	DIN 15 rail, steel/slotted, 6.6 ft • 2 meters long
249-116	Screwless end stop for carrier rail

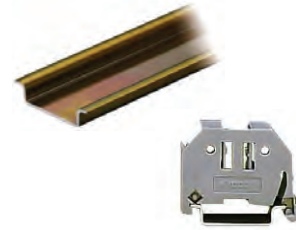

Ferrules



Part Number	Description
Ask for specific sizes	Insulated ferrules, 0.25 mm ² to 16 mm ²
Ask for specific sizes	Uninsulated ferrules, 0.25 mm ² to 16 mm ²



Connectors



Part Number	Description
730-103	Female socket, 3-pole, IDC connection, live conductor automatically cut, 18 to 16 AWG
730-106	Female socket, 6-pole, IDC connection, 18 to 16 AWG
730-113	Wire-tap branch male connector, 3-pole, 28 to 14 AWG
730-116	Wire-tap branch male connector, 6-pole, 28 to 14 AWG
730-123	Wire-tap branch female connector, 3-pole, 18 to 16 AWG
730-126	Wire-tap branch female connector, 6-pole, 18 to 16 AWG
222-412	Lever nuts, 2-pole Cage Clamp® connection, 28 to 14 AWG



Metal Wireway

UL 870 AND CSA C22.2 NO. 26, MEETS ELEVATOR INDUSTRY STANDARDS

Galvanized steel wireway



Part Number	Dimension A inches	Dimension B inches	Dimension C inches
UGTR 2525120CSA	2-1/2	2-1/2	120
UGTR 254120CSA	2-1/2	4	120
UGTR 256120CSA	2-1/2	6	120
UGTR 258120CSA	2-1/2	8	120
UGTR 44120CSA	4	4	120
UGTR 46120CSA	4	6	120
UGTR 48120CSA	4	8	120
UGTR 66120CSA	6	6	120
UGTR 88120CSA	8	8	120

Wireway comes with two five-foot covers, #10-5/16 hexhead screws and screw protection and spot-welded coupling on one end.

Special size wireway and wireway without knockouts are available with short lead times. Call Draka Elevator at 1-877-372-5237 for further information.

Tolerances: Inside dimensions from 0 to + 1/16 in.; joints, corners and adjoining edges to + 1/32 in.; screw and hole placement to + 1/32 in.

Materials: Hot-dipped, mill-galvanized steel

General: Uniform knockouts 1/2 in. and 3/4 in. every 12 in. EXCEPT FOR UGTR 254120CSA which has knockouts 1/2 in., 3/4 in. and 1 in. every 12 in.

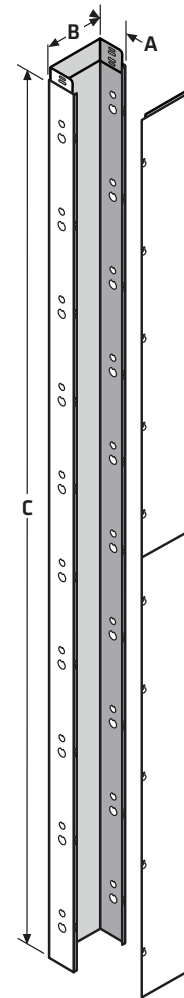

Covers and screws

Part Number	Description	Dimension B inches	Dimension D inches
C U25	Cover	2-1/2	60
C U44	Cover	4	60
C U66	Cover	6	60
C U88	Cover	8	60
59-020	Cover screw, #10-32 x 1/2 in.		

Wireway nuts & bolts – used to attach fittings to wireway

Part Number	Size inches	Standard Packaging
26-006A	1/4 x 1/2 nut and bolt	25
26-006B	1/4 x 1/2 nut and bolt	50
26-006C	1/4 x 1/2 nut and bolt	100

Plastic U-channel

Part Number	Description
19-003	Plastic U-channel, available in 100 ft. rolls

Wireway mounting bracket kit – used to attach wireway to steel I-beams

Part Number	Description	Quantity
TR-MTG-KIT	Bracket, with 5 in. mounting bolt, nut and two washers	1

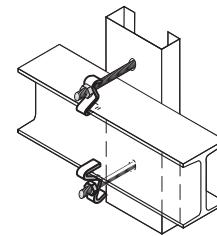

Strain bars

Part Number	For wireway width inches
STB 25	2-1/2
STB 4	4
STB 6	6
STB 8	8

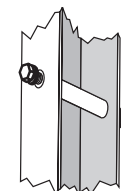

The NEC requires supports, like strain bars, to be used every 100 ft. in wireway.



Metal Wireway

UL 870 AND CSA C22.2 NO. 26

90° elbows/Type C



Part Number	Dimension A inches	Dimension B inches	Dimension C inches	For use with Wireway P/N
UL90 2525CSA	2-1/2	2-1/2	6-1/4	UGTR 2525120CSA
UL90 254CSA	2-1/2	4	7-3/4	UGTR 254120CSA
UL90 256CSA	2-1/2	6	9-3/4	UGTR 256120CSA
UL90 258CSA	2-1/2	8	11-3/4	UGTR 258120CSA
UL90 44CSA	4	4	7-3/4	UGTR 44120CSA
UL90 46CSA	4	6	9-3/4	UGTR 46120CSA
UL90 48CSA	4	8	11-3/4	UGTR 48120CSA
UL90 66CSA	6	6	9-3/4	UGTR 66120CSA
UL90 88CSA	8	8	11-3/4	UGTR 88120CSA

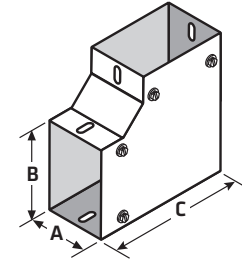

90° elbows/Type D



Part Number	Dimension A inches	Dimension B inches	Dimension C inches	For use with Wireway P/N
UL90 425CSA	2-1/2	4	6-1/4	UGTR 254120CSA
UL90 625CSA	2-1/2	6	6-1/4	UGTR 256120CSA
UL90 825CSA	2-1/2	8	6-1/4	UGTR 258120CSA
UL90 64CSA	4	6	7-3/4	UGTR 46120CSA
UL90 84CSA	4	8	7-3/4	UGTR 48120CSA

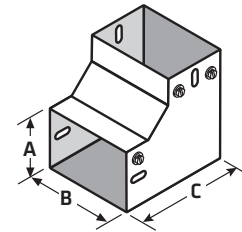

45° elbows/Type C



Part Number	Dimension A inches	Dimension B inches	Dimension C inches	For use with Wireway P/N
UL45 2525CSA	2-1/2	2-1/2	4-9/16	UGTR 2525120CSA
UL45 254CSA	2-1/2	4	5-1/4	UGTR 254120CSA
UL45 256CSA	2-1/2	6	6	UGTR 256120CSA
UL45 258CSA	2-1/2	8	6-1/2	UGTR 258120CSA
UL45 44CSA	4	4	5-1/4	UGTR 44120CSA
UL45 46CSA	4	6	6	UGTR 46120CSA
UL45 48CSA	4	8	6-1/2	UGTR 48120CSA
UL45 66CSA	6	6	6	UGTR 66120CSA
UL45 88CSA	8	8	6-1/2	UGTR 88120CSA

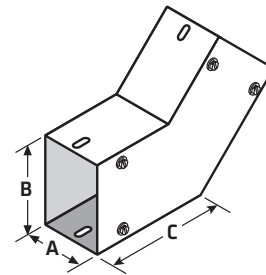

45° elbows/Type D



Part Number	Dimension A inches	Dimension B inches	Dimension C inches	For use with Wireway P/N
UL45 425CSA	2-1/2	4	4-9/16	UGTR 254120CSA
UL45 625CSA	2-1/2	6	4-9/16	UGTR 256120CSA
UL45 825CSA	2-1/2	8	4-9/16	UGTR 258120CSA
UL45 64CSA	4	6	5-1/4	UGTR 46120CSA
UL45 84CSA	4	8	5-1/4	UGTR 48120CSA

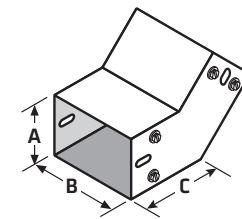

Elbows come with #10-5/16 hexhead screws & screw protection.

Special size wireway and wireway without knockouts are available with short lead times.

Tolerances: Inside dimensions from 0 to + 1/16 in.;
joints, corners and adjoining edges to + 1/32 in.;
screw and hole placement to + 1/32 in.;

Materials: Hot-dipped, mill-galvanized steel

General: Connector slots 3/4 x 1/4 in.

Metal Wireway

UL 870 AND CSA C22.2 NO. 26

Tees/Type C



Part Number	Dimension A inches	Dimension B inches	Dimension C inches	For use with Wireway P/N
UTEE 2525CSA	2-1/2	2-1/2	9-7/8	UGTR 2525120CSA
UTEE 254CSA	2-1/2	4	9-7/8	UGTR 254120CSA
UTEE 256CSA	2-1/2	6	9-7/8	UGTR 256120CSA
UTEE 258CSA	2-1/2	8	9-7/8	UGTR 258120CSA
UTEE 44CSA	4	4	11-3/8	UGTR 44120CSA
UTEE 46CSA	4	6	11-3/8	UGTR 46120CSA
UTEE 48CSA	4	8	11-3/8	UGTR 48120CSA
UTEE 66CSA	6	6	13-3/8	UGTR 66120CSA
UTEE 88CSA	8	8	15-3/8	UGTR 88120CSA

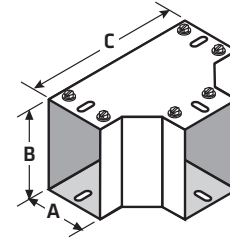

Tees/Type D



Part Number	Dimension A inches	Dimension B inches	Dimension C inches	For use with Wireway P/N
UTEE 425CSA	2-1/2	4	11-3/8	UGTR 254120CSA
UTEE 625CSA	2-1/2	6	13-3/8	UGTR 256120CSA
UTEE 825CSA	2-1/2	8	15-3/8	UGTR 258120CSA
UTEE 64CSA	4	6	13-3/8	UGTR 46120CSA
UTEE 84CSA	4	8	15-3/8	UGTR 48120CSA

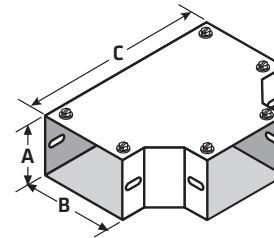

Crossovers/Type C



Part Number	Dimension A inches	Dimension B inches	Dimension C inches	For use with Wireway P/N
UCRS 2525CSA	2-1/2	2-1/2	9-7/8	UGTR 2525120CSA
UCRS 254CSA	2-1/2	4	9-7/8	UGTR 254120CSA
UCRS 256CSA	2-1/2	6	9-7/8	UGTR 256120CSA
UCRS 258CSA	2-1/2	8	9-7/8	UGTR 258120CSA
UCRS 44CSA	4	4	11-3/8	UGTR 44120CSA
UCRS 46CSA	4	6	11-3/8	UGTR 46120CSA
UCRS 48CSA	4	8	11-3/8	UGTR 48120CSA
UCRS 66CSA	6	6	13-3/8	UGTR 66120CSA
UCRS 88CSA	8	8	15-3/8	UGTR 88120CSA

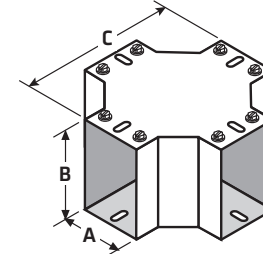

Crossovers/Type D



Part Number	Dimension A inches	Dimension B inches	Dimension C inches	For use with Wireway P/N
UCRS 425CSA	2-1/2	4	11-3/8	UGTR 254120CSA
UCRS 625CSA	2-1/2	6	13-3/8	UGTR 256120CSA
UCRS 825CSA	2-1/2	8	15-3/8	UGTR 258120CSA
UCRS 64CSA	4	6	13-3/8	UGTR 46120CSA
UCRS 84CSA	4	8	15-3/8	UGTR 48120CSA

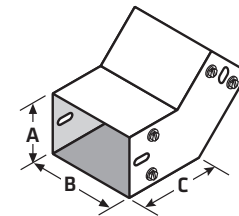

Tees and crossovers come with #10-5/16 hexhead screws and screw protection.

Special size wireway and wireway without knockouts are available with short lead times.

Tolerances: Inside dimensions from 0 to + 1/16 in.;
joints, corners and adjoining edges to + 1/32 in.;
screw and hole placement to + 1/32 in.

Materials: Hot-dipped, mill-galvanized steel

General: Connector slots 3/4 x 1/4 in.



Metal Wireway

UL 870 AND CSA C22.2 NO. 26

Couplings



Part Number	Dimension A inches	Dimension B inches
UCON 2525CSA	2-1/8	2-7/16
UCON 254CSA	2-1/8	3-15/16
UCON 256CSA	2-1/8	5-15/16
UCON 258CSA	2-1/8	7-15/16
UCON 44CSA	3-5/8	3-15/16
UCON 46CSA	3-5/8	5-15/16
UCON 48CSA	3-5/8	7-15/16
UCON 66CSA	5-5/8	5-15/16
UCON 88CSA	7-5/8	7-15/16

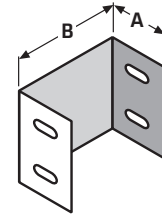

Panel connectors



Part Number	Dimension A inches	Dimension B inches
UPCN 2525CSA	2-1/8	2-7/16
UPCN 254CSA	2-1/8	3-15/16
UPCN 256CSA	2-1/8	5-15/16
UPCN 258CSA	2-1/8	7-15/16
UPCN 44CSA	3-5/8	3-15/16
UPCN 46CSA	3-5/8	5-15/16
UPCN 48CSA	3-5/8	7-15/16
UPCN 66CSA	5-5/8	5-15/16
UPCN 88CSA	7-5/8	7-15/16

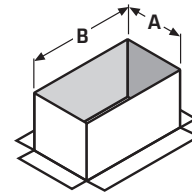

End plates



Part Number	Dimension A inches	Dimension B inches
UEPT 2525CSA	2-1/8	2-7/16
UEPT 254CSA	2-1/8	3-15/16
UEPT 256CSA	2-1/8	5-15/16
UEPT 258CSA	2-1/8	7-15/16
UEPT 44CSA	3-5/8	3-15/16
UEPT 46CSA	3-5/8	5-15/16
UEPT 48CSA	3-5/8	7-15/16
UEPT 66CSA	5-5/8	5-15/16
UEPT 88CSA	7-5/8	7-15/16

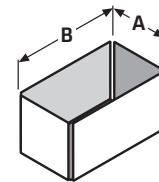

Insulated bushings



Part Number	Dimension A inches	Dimension B inches
UISB 2525CSA	2-1/8	2-7/16
UISB 254CSA	2-1/8	3-15/16
UISB 256CSA	2-1/8	5-15/16
UISB 258CSA	2-1/8	7-15/16
UISB 44CSA	3-5/8	3-15/16
UISB 46CSA	3-5/8	5-15/16
UISB 48CSA	3-5/8	7-15/16
UISB 66CSA	5-5/8	5-15/16
UISB 88CSA	7-5/8	7-15/16

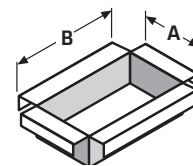

Special size wireway and wireway without knockouts are available with short lead times.

Metal Wireway

UL 870 AND CSA C22.2 NO. 26

Reducers



Part Number	Adapts from this size... inches	to this size inches
URED 2542525CSA	2-1/2 x 4	2-1/2 x 2-1/2
URED 254256CSA	2-1/2 x 4	2-1/2 x 6
URED 25666CSA	2-1/2 x 6	6 x 6
URED 25888CSA	2-1/2 x 8	8 x 8
URED 442525CSA	4 x 4	2-1/2 x 2-1/2
URED 44254CSA	4 x 4	2-1/2 x 4
URED 44256CSA	4 x 4	2-1/2 x 6
URED 4446CSA	4 x 4	4 x 6
URED 4448CSA	4 x 4	4 x 8
URED 46254CSA	4 x 6	2-1/2 x 4
URED 48254CSA	4 x 8	2-1/2 x 4
URED 6644CSA	6 x 6	4 x 4
URED 6664CSA	6 x 6	6 x 4
URED 8844CSA	8 x 8	4 x 4
URED 25844CSA	2-1/2 x 8	4 x 4
URED 48256CSA	4 x 8	2-1/2 x 6
URED 8848CSA	8 x 8	4 x 8
URED 8866CSA	8 x 8	6 x 6

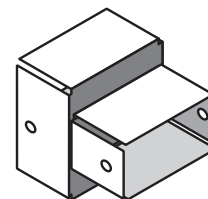

Special size wireway and wireway without knockouts are available with short lead times.

Tolerances: Inside dimensions from 0 to + 1/16 in.;
joints, corners and adjoining edges to + 1/32 in.;
screw and hole placement to + 1/32 in.

Materials: Hot-dipped, mill-galvanized steel



Electrical Metallic Tubing (EMT) and Fittings

UL LISTED, CSA CERTIFIED AS NOTED

EMT - lightweight, thin wall

Part Number	Trade Sizes
01-001	1/2
01-002	3/4
01-003	1
01-004	1-1/4
01-005	1-1/2
01-006	2
01-007	2-1/2



90° elbows

Part Number	Trade Sizes
02-005	1/2
02-006	3/4
02-001	1
02-002	1-1/4
02-003	1-1/2
02-004	2
02-010	2-1/2



Steel one-hole straps

Part Number	Trade Sizes
05-000*	3/8
05-001	1/2
05-002	3/4
05-003	1
05-004	1-1/4
05-005	1-1/2
05-006	2
05-014	2-1/2

*05-000 not CSA certified



Steel hangers with bolts

Part Number	Trade Sizes
78-053	1/2
78-078	3/4
78-054	1
78-080	1-1/4
78-055	1-1/2



Die-cast chase nipples

Part Number	Trade Sizes
06-001	1/2
06-002	3/4
06-005	1
06-009	1-1/4
06-010	1-1/2
06-003	2
06-011	2-1/2



Steel lock nuts

Part Number	Trade Sizes
07-001	1/2
07-002	3/4
07-005	1
07-006	1-1/4
07-004	1-1/2
07-003	2
07-007	2-1/2



Threaded insulated bushings

Part Number	Trade Sizes
27-006	1/2
27-007	3/4
27-005	1
27-002	1-1/4
27-003	1-1/2
27-004	2
27-022	2-1/2



Steel reducing washers

Part Number	Trade Sizes
45-001	3/4 - 1/2
45-002	1 - 1/2
45-009	1 - 3/4
45-014	1-1/4 - 1/2
45-024	1-1/4 - 3/4
45-008	1-1/4 - 1
45-010	1-1/2 - 1
45-003	1-1/2 - 1-1/4
45-004	2 - 1-1/4
45-005	2 - 1-1/2
45-038	2-1/2 - 1



Electrical Metallic Tubing (EMT) Fittings

UL LISTED, CSA CERTIFIED

Die-cast compression connectors

Part Number	Trade Size
08-001	1/2
08-002	3/4
08-003	1
08-004	1-1/4
08-005	1-1/2
08-006	2
08-007	2-1/2



Steel compression connectors

Part Number	Trade Sizes
69-004	1/2
69-005	3/4
69-006	1
69-007	1-1/4
69-008	1-1/2
69-009	2



Die-cast set screw connectors

Part Number	Trade Sizes
08-021	1/2
08-022	3/4
08-023	1
08-024	1-1/4
08-025	1-1/2
08-026	2
08-027	2-1/2



Steel set screw connectors

Part Number	Trade Sizes
69-010	1/2
69-011	3/4
69-012	1
69-013	1-1/4
69-014	1-1/2
69-015	2



Die-cast compression couplings

Part Number	Trade Sizes
09-001	1/2
09-002	3/4
09-003	1
09-004	1-1/4
09-005	1-1/2
09-006	2
09-013	2-1/2



Steel compression couplings

Part Number	Trade Sizes
69-016	1/2
69-017	3/4
69-018	1
69-019	1-1/4
69-020	1-1/2
69-021	2



Die-cast set screw couplings

Part Number	Trade Sizes
09-027	1/2
09-028	3/4
09-029	1
09-030	1-1/4
09-031	1-1/2
09-032	2
09-033	2-1/2



Steel set screw couplings

Part Number	Trade Sizes
69-022	1/2
69-023	3/4
69-024	1
69-025	1-1/4
69-026	1-1/2
69-027	2





EMT Conduit Bodies and EMT-to-Flex Couplings

UL LISTED, CSA CERTIFIED

Type LB / set screw (cover separate)



Part Number	Trade Sizes
30-011	1/2
30-012	3/4
30-013	1
30-014	1-1/4
30-015	1-1/2
30-021	2
30-023 ¹	2-1/2

¹30-023 comes with cover



EMT-to-flex compression couplings - malleable iron



Part Number	Trade Sizes
69-049	1/2 EMT to 3/8 flex
69-048	1/2 EMT to 1/2 flex
69-050	3/4 EMT to 3/4 flex
12-004	1 EMT to 1 flex
12-006	1-1/4 EMT to 1-1/4 flex
12-007	1-1/2 EMT to 1-1/2 flex
12-005	2 EMT to 2 flex



Type LR / set screw (cover separate)



Part Number	Trade Sizes
30-030	1/2
30-031	3/4
30-032	1
30-033	1-1/4
30-034	1-1/2
30-035	2



EMT-to-flex squeeze couplings - set screw/die-cast



Part Number	Trade Sizes
12-001	1/2 EMT to 3/8 flex
12-002	1/2 EMT to 1/2 flex
12-003	3/4 EMT to 3/4 flex
12-016	1 EMT to 1 flex



Type LL / set screw (cover separate)



Part Number	Trade Sizes
30-040	1/2
30-041	3/4
30-042	1
30-043	1-1/4
30-044	1-1/2
30-045	2



EMT-to-flex couplings



Part Number	Trade Sizes
12-012	1/2 EMT to flex
12-013	3/4 EMT to flex



Covers for conduit bodies



Part Number	Trade Sizes
30-017	1/2
30-018	3/4
30-019	1
30-020	1-1/4 to 1-1/2
30-022	2



Flexible Conduit and Fittings

UL LISTED, CSA CERTIFIED AS NOTED

Thin-wall steel conduit

Part Number	Trade Sizes
03-001	3/8
03-002	1/2
03-003	3/4
03-004	1
03-005	1-1/4
03-006	1-1/2
03-007	2



Malleable iron 90° squeeze-type flex box connectors

Part Number	Trade Sizes
69-028	3/8
69-029	1/2
69-030	3/4
69-031	1
69-032	1-1/4
69-033	1-1/2



Die-cast 90° squeeze-type flex box connectors

Part Number	Trade Sizes
11-001	3/8
11-002	1/2
11-003	3/4
11-004	1
11-005	1-1/4
11-006	1-1/2
11-008	2



Malleable iron straight squeeze-type flex box connectors

Part Number	Trade Sizes
69-035	3/8
69-036	1/2
69-037	3/4
69-038	1
69-039	1-1/4
69-040	1-1/2
69-041	2



Die-cast straight squeeze-type flex box connectors

Part Number	Trade Sizes
10-001	3/8
10-002	1/2
10-003	3/4
10-004	1
10-005	1-1/4
10-006	1-1/2
10-010	2



Screw-in connectors for flex

Part Number	Trade Sizes
10-021	1/2
10-022	3/4
10-023	1
10-035	1-1/4
10-029	1-1/2
10-036	2
11-045	90° 'jake L' for 1/2
11-046	90° 'jake L' for 3/4
11-064	90° 'jake L' for 1



Die-cast 45° squeeze-type flex box connectors

Part Number	Trade Sizes
11-034	3/8
11-035	1/2
11-036	3/4



Screw-in couplings for flex

Part Number	Trade Sizes
12-101	1/2
12-102	3/4
12-100	1



Roto-Flex cutter for flexible conduit





Threaded Fittings for Rigid Pipe

UL LISTED, CSA CERTIFIED AS NOTED

LB conduit bodies



Part Number	Trade Sizes
30-052	1/2, includes cover & gasket
30-058	3/4, includes cover & gasket
30-053	1, includes cover & gasket
30-065	1-1/4, includes cover & gasket
30-066	1-1/2, includes cover & gasket
30-046	2, includes cover & gasket
30-051	2-1/2, includes cover & gasket



TEE conduit bodies



Part Number	Trade Sizes
30-106	1/2, includes cover & gasket
30-107	3/4, includes cover & gasket
30-115	1, includes cover & gasket
31-044	1-1/4, includes cover & gasket
30-105	1-1/2, includes cover & gasket
30-108	2, includes cover & gasket



LR conduit bodies



Part Number	Trade Sizes
30-061	1/2, includes cover & gasket
30-049	3/4, includes cover & gasket
30-113	1, includes cover & gasket
30-084	1-1/4, includes cover & gasket
30-088	1-1/2, includes cover & gasket
30-080	2, includes cover & gasket
30-116	2-1/2, includes cover & gasket



Threaded couplings



Part Number	Trade Sizes
09-041	1/2
09-042	3/4
09-052	1
09-045	1-1/4
09-046	1-1/2
09-043	2
09-044	2-1/2



LL conduit bodies



Part Number	Trade Sizes
30-056	1/2, includes cover & gasket
30-086	3/4, includes cover & gasket
30-114	1, includes cover & gasket
30-083	1-1/4, includes cover & gasket
30-087	1-1/2, includes cover & gasket
30-079	2, includes cover & gasket
30-054	2-1/2, includes cover & gasket



Electrical Boxes

UL LISTED

4" square '1900' boxes
1-1/2" deep - type 52151

Part Number	K/O Trade Sizes
04-020	1/2
04-021	3/4
04-022	1/2 & 3/4



4" x 2-1/8" utility
'handy' boxes
1-7/8" deep - type 58361

Part Number	K/O Trade Sizes
04-026	1/2
04-027	3/4



4" square '1900' boxes
2-1/8" deep - type 52171

Part Number	K/O Trade Sizes
04-024	1/2 & 3/4
04-025	1



4" x 2-1/8" utility
'handy' boxes
2-1/8" deep - type 58371

Part Number	K/O Trade Sizes
04-028	1/2
04-029	3/4



4-11/16" square boxes
2-1/8" deep - type 72171

Part Number	K/O Trade Sizes
04-041	1/2 & 3/4



4" octagonal boxes
1-1/2" deep - type 54151

Part Number	K/O Trade Sizes
42-012	1/2
42-011	3/4



4" octagonal boxes
2-1/8" deep - type 54171

Part Number	K/O Trade Sizes
42-008	1



Other threaded items available with short lead times.



Box Covers, Plates and Fixtures

UL LISTED, CSA CERTIFIED

4" x 4" box cover



Part Number	Fits these Part Numbers
04-030	04-020 04-021 04-022 04-024 04-025



4-11/16" x 4-11/16" box cover



Part Number	Fits these Part Numbers
04-040	04-041



4" x 2-1/8" box cover



Part Number	Fits these Part Numbers
04-037	04-026 04-027 04-028 04-029



4" x 4" octagonal box cover



Part Number	Fits these Part Numbers
42-013	42-008 42-011 42-012



4" x 2-1/8" outlet cover



Part Number	Fits these Part Numbers
04-038	04-026 04-027 04-028 04-029



4" x 2-1/8" switch cover



Part Number	Fits these Part Numbers
04-038	04-026 04-027 04-028 04-029



GFCI outlet



Part Number	Description
37-178	GFCI with cover 125VAC, 15A



Junction Boxes and Knockout Punches/Plugs

UL LISTED, CSA CERTIFIED AS NOTED

Junction boxes – fully assembled with cover and terminals

Part Number	H x W inches	Depth and Capacity inches • wire count
43-036	13-3/4 x 8-1/2	3-1/4 • 36 terminals, 72 wires
43-072	24 x 8-1/2	3-1/4 • 72 terminals, 144 wires
43-108	36 x 8-1/2	3-1/4 • 108 terminals, 216 wires

Junction boxes have knockouts on top, bottom and sides.
 Top/bottom knockouts are 2 and 1-1/2 in. - sides are 2, 1-1/2, 3/4 and 1/2 in.
 Photo shows box with components that may also be ordered separately.

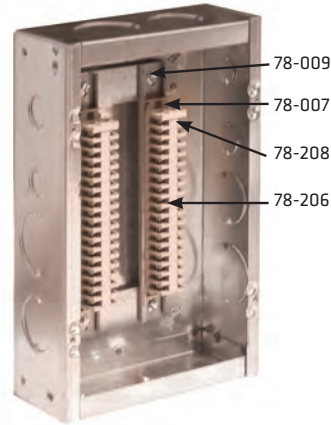

Junction box components



Part Number	Description
78-206	Tubular terminal clamps (Buchanan 0925) for wire sizes 22 to 10 AWG
78-007	Channel clamps (Buchanan 61)
78-208	End section (Buchanan 0930)
78-009*	Zinc-plated track (Buchanan 60)

*78-009 is not UL listed/CSA certified.



Screw-cover pull boxes – with cover and knockouts



Part Number	H x W inches	Depth inches	K/O Pattern
42-007	4 x 4	4	A
42-006	6 x 6	4	B
42-054	8 x 8	4	B
42-025	10 x 10	4	B
42-051	12 x 12	4	C
42-022	18 x 18	4	D
42-021	24 x 24	4	D
42-055	8 x 8	6	B



Pattern A
1/2 - 3/4"

Pattern B
1/2 - 3/4" and 3/4 - 1"

Pattern C
1/2 - 3/4" and 3/4 - 1"

Pattern D
1/2 - 3/4" and 3/4 - 1"

Metal knockout plug

Part Number	Size inches
19-021	1/2
19-026	3/4
19-027	1
19-028	1-1/4
19-029	1-1/2
19-030	2





Wire Rope Ordering Information

WIRE ROPE MANUFACTURED BY GUSTAV WOLF

IMPORTANT NOTE:

New Wire Ropes and Existing Sheaves

IT IS STRONGLY RECOMMENDED that the sheaves of existing elevators be carefully checked and re-grooved or replaced as necessary prior to rope replacement.

The diameter of the new ropes is greater than that of the old ropes and failure to bring the sheave grooves into the machine manufacturer's specified tolerances can lead to vibration, metal shavings and other problems.

General information

Gustav Wolf offers a full line of elevator wire ropes, including:

"Low-stretch" natural fiber core wire rope in Iron, Traction and Extra High Strength Traction grades that provide the benefits of pre-stretching without paying the premium price,

PAWO F3 and PAWO F10 wire rope for high-rise/high-speed elevators to reduce or eliminate the labor cost of repeated rope shortenings. They can be used wherever EHST grade is specified, and

CompactTrac™ compacted-strand natural fiber core wire rope for use with reverse bends and basement machines to extend rope life.

Ordering hoist ropes

The information needed to order hoist ropes is the number (quantity), length and diameter of the ropes; the stranding, construction and lay; the grade or tensile strength; and the breaking force (load or strength). While this information may be provided on the wire rope tag, it should be noted that the tag information may not always be accurate; it is not uncommon to find that the wrong tag has been applied. Use the following procedure for ordering hoist ropes for a traction elevator:

- 1) Count the number of ropes on the elevator.**
- 2) Determine the length of each rope.** The length can often be found on the installation layout.
- 3) Measure the diameter of the rope.** If you don't have a measuring tool, the crosshead data plate on top of the car should show the diameter or the diameter may be stamped on the existing shackles.
- 4) Determine the stranding and construction of the rope.** Stranding is the number of strands per rope and the number of wires per strand (e.g. an 8-strand rope with 19 wires per strand has 8 x 19 stranding). Determine whether the rope has 6, 8 or 9 strands by looking at the shackles where the stranding is more easily seen. The rope construction (Seale, Warrington, Filler Wire, etc.) can be found by matching up the rope cross-section with the cross-sections shown in this catalog.

If there is not a crosshead data plate and the building is over 50 years old, the ropes used are usually 6 x 25 Filler Wire with Right Regular lay (most 6-strand hoist ropes are of this construction). An 8-strand hoist rope is usually 8 x 19 Seale. Lay can vary (see Step 5 below).

- 5) Determine the lay of the rope.** Compare a Right Regular lay rope to a Right Lang lay rope:

Right Regular



Right Lang



Note that the orientation of the individual wires is parallel to the centerline in a Right Regular lay rope. Right Regular lay is assumed if the lay is not indicated on your order.

- 6) Determine the grade or tensile strength of the rope.** In North America, grades are commonly expressed as Iron, Traction or Extra High Strength Traction (EHST).

Iron rope is normally used for governor and compensation ropes.

Traction rope can be used for hoist, governor and compensation applications.

Extra High Strength Traction (EHST) rope is frequently specified for high-rise/high-speed hoisting conditions.

Grade is sometimes expressed as tensile strength in Newtons/square millimeter (N/mm²) or pounds/square inch (psi).

- 7) Determine the breaking force,** which can aid in confirming the grade and is usually indicated on the crosshead data plate. For example, if a breaking load of 14,500 lbf • 64,500 N is indicated for 1/2 in • 12.7 mm 8 x 19 ropes, refer to the information in this catalog or call your Gustav Wolf representative for the correct grade (in this case, traction grade).

Other considerations

Core: The purpose of the core is to provide support for the strands. Natural fiber is the most common core used in elevator ropes in North America. However, in some high-rise/high-speed, most MRL and certain hydraulic applications, the use of steel-reinforced or full steel core (IWRC) ropes is becoming more common.

Preforming: In the preforming process, the strands are formed into a helix (spiral) prior to closing. Preformed rope is the industry standard and provides longer service life while being easier to handle. All the ropes in this catalog are preformed.

Coating: Bright (uncoated) is the industry standard and comes without any coating on the rope other than lubrication. For protection from weather and corrosion (e.g. outdoor and mine elevators), the use of a galvanized coating is often recommended. Gustav Wolf 3/8 in • 9.5 mm, 1/2 in • 12.7 mm and 5/8 in • 15.9 mm 8 x 19 Seale galvanized hoist/governor ropes in traction grade are in stock for immediate delivery.

Compacted strands: A rope design with flattened wires/strands to increase contact area, reduce surface pressure and help to extend rope service life associated with rope fatigue due to reverse bends (e.g. basement machines).

Stretch/Elongation: Elevator wire rope stretch results from two main factors. Elastic stretch is an increase in rope length due to increase in load (as load increases, the rope becomes longer and narrower and vice versa). Constructional stretch is an increase in rope length due to the settling/compression of the core and strands when a load is applied (most occurs shortly after the rope is put into service). Ropes made by different manufacturers and ropes of different strandings, constructions, grades, etc. exhibit different stretch characteristics.

Prestretching: Some wire rope manufacturers promote pre-stretched rope at a premium price. Laboratory testing has shown that standard Gustav Wolf natural fiber core rope exhibits comparable elongation to commonly used brands of pre-stretched fiber core rope without the associated increase in price. Contact your Draka representative for more information on Gustav Wolf low-stretch natural fiber core wire rope.

Wire Rope Ordering Information

WIRE ROPE MANUFACTURED BY GUSTAV WOLF

Ordering governor and/or compensation ropes

The ordering procedure is similar to hoist ropes but you may have to rely on the rope tag to a greater degree because there is no crosshead data plate for governor or compensation ropes. However:

- 1) Measure the diameter of the rope.** Use a caliper, micrometer or Go/No Go gauge.
- 2) Go to the shackles and confirm the stranding (6 or 8) of the ropes.** Almost all compensation and governor ropes have 8 strands (refer to the rope cross-sections shown in this catalog).

Look at the rope tag to determine breaking strength and then refer to the information in this catalog or contact your Draka representative for the correct grade (Iron or Traction).

- 3) Consider the rope grade or tensile strength.** Governor and compensation ropes are either Iron or Traction – never Extra High Strength Traction (EHST).

- 4) Confirm the lay of the rope.** Governor and compensation ropes are always Right Regular lay and never Right Lang lay.

Other considerations

Preformed rope is always preferred for its longer life and ease of installation.

Replace all governor and compensation ropes with preformed ropes.

Handling of wire ropes prior to and during installation

Reels are best transported on the job site by rolling on a clean flat surface or by lifting from a pipe in the reel center hole.

Wire rope should be stored indoors, off the ground and covered to protect it from moisture, dirt, dust, sunlight, etc.

Care must be taken to unroll and not laterally pull wire rope when paying it off the reel. Kinking and dragging ropes over sharp edges must be avoided.

Ropes must be prevented from rotating during installation since free-hanging ropes will untwist under their own weight.

Loose rope ends should always be seized or secured with cable bands to prevent untwisting.

The installers should continually inspect wire rope during installation to identify any areas which may have been damaged in shipment or while in storage on the job site. Per ASME A17.1b-2009/CSA B44b-09 8.6.3.2 and ASME A17.6-2010 1.10.5, where one suspension rope has been damaged during installation or acceptance testing prior to being subjected to elevator service, it shall be permissible to replace a single damaged rope with a new rope, provided that the requirements of 8.6.3.2.1 through 8.6.3.2.6 and 1.10.4.4 and 1.10.5.1 through 1.10.5.6 respectively are met.

Use these tools to cut and measure wire rope.

#WR-IMPACT
Impact cutter



#WR-HYDRAULIC
Hydraulic cutter



#WR-RATCHET
Ratchet cutter



#WR-MT
Rope gauge



#WR-QBTM-2
Tension meter



#WR-CALIPER-C
Digital caliper



Tensioning

It is important to equally tension all the hoist ropes immediately after installation and during subsequent inspections in order to avoid differential wear of sheave grooves and ropes and to extend rope service life.

Ropes are considered to be equally tensioned when the smallest tension measured is within 10% of the highest tension measured. Ropes with greater tension/load will press harder into the sheave grooves resulting in increased overall rope wear while ropes with lesser tension/load will slide through the sheave grooves causing increased crown and sheave wear.

Highly accurate rope tension measuring devices are available which allow the quick and accurate checking of tension.

Field lubrication policy

Draka strongly recommends an annual lubrication application every spring, if the ropes become dry or at 250,000 cycles, whichever occurs first.

Ropes should be lubricated prior to summer and the increased temperature and humidity it brings. Condensation caused by the combination of an air conditioned machine room and a humid hoistway must be kept from entering the rope core.

The practice of re-lubrication based on time interval alone is no longer valid. As already mentioned, ropes on modern elevators are subject to greater stress which requires that cycle counts also be considered when deciding the right time to re-lubricate. Studies show that following the 250,000 cycle guideline will contribute to extended rope service life. **Never field lubricate governor ropes.** See Draka Tech Tip #6 for detailed lubrication instructions.

Wire rope may be paid off a reel supported by jack stands with a helper using a board as a brake...

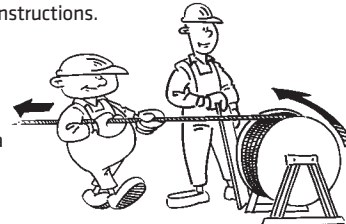

...or by paying it off a coil as the helper rotates it...

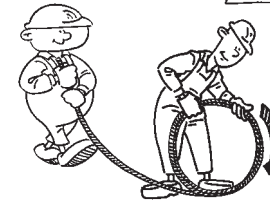

...or by paying it off a bollard as the helper rotates it.

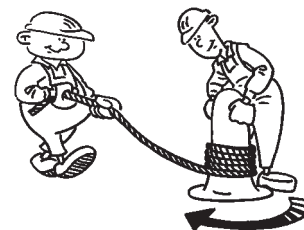



Wire Rope Selection Guide

IMPERIAL DIAMETERS WITH PART NUMBERS, E-MODULE AND ELONGATION VALUES

Application	Recommended Rope and Rope Part Number	Rope Description	E-Module [†] n/mm ²	Stretch ^{††} per 100' • 30 m of Hoist Rope (Elastic) + (Constructional) = Total inches • mm
Hoist for Low/Mid-rise (up to 200' • 60 m)	F 819 S-FE DT	8x19 Seale traction grade	65000 - 70000	(2 - 3) + (2 - 4) = 4 - 7 inches • (51 - 76) + (51 - 102) = 102 - 178 mm
	3/8" = 80-001-A	natural fiber core		
	1/2" = 80-002-A			
	5/8" = 80-003-A			
Hoist for Mid/High-rise (> 200' • 60 m)	F 819 S-FE DT EHS	8x19 Seale EHS traction grade	65000 - 70000	(2 1/2 - 3) + (2 - 4 1/2) = 4 1/2 - 7 1/2 inches • (63 - 76) + (51 - 114) = 114 - 190 mm
	3/8" = 80-001EHS-A	natural fiber core		
	1/2" = 80-002EHS-A			
	5/8" = 80-003EHS-A			
	PAWO F3	8x19 Seale EHS traction grade*	75000 - 80000	(1 1/2 - 2) + (1 1/2 - 2) = 3 - 4 inches • (38 - 51) + (38 - 51) = 76 - 102 mm
	3/8" = 80-016-A	steel reinforced natural fiber core		
	1/2" = 80-020-A	(lower-stretch alternative to F 819 S-FE DT EHS above)		
	5/8" = 80-024-A			
Hoist for High-rise (> 300' • 90 m)	PAWO F10	9x17 or 9x21 Filler Wire EHS traction grade*	80000 - 85000	(1 1/2 - 2) + (1/2 - 1) = 2 - 3 inches • (38 - 51) + (13 - 25) = 51 - 76 mm
	3/8" = 80-104	full steel core		
	1/2" = 80-108			
	5/8" = 80-113			
Hoist for Installations with Reverse Bends (e.g. Basement Machines)	CompactTrac™	8x19 Seale/compacted strands traction grade	65000 - 70000	(2 - 3) + (2 - 4) = 4 - 7 inches • (51 - 76) + (51 - 102) = 102 - 178 mm (these are estimated dimensions)
	3/8" = 80-001CSLL-A	natural fiber core		
	1/2" = 80-002CSLL-A			
Governor (select Seale in Traction or Warrington in Traction or Iron)	F 819 S-FE DT	8x19 Seale traction grade	n/a	n/a
	1/4" = 80-000-A	natural fiber core		
	3/8" = 80-001-A			
	1/2" = 80-002-A			
	F 819 W-FE DT	8x19 Warrington traction grade	n/a	n/a
	3/8" = 80-001W	natural fiber core		
	F 819 W-FE DT Iron	8x19 Warrington iron grade	n/a	n/a
	3/8" = 80-010IRONW	natural fiber core		
7/16" = 80-007IRON-K (Seale)				
Compensation/Governor (select Traction or Iron)	F 819 F-FE DT	8x25 Filler Wire traction grade	n/a	n/a
	1/2" = 80-002FW	natural fiber core		
	5/8" = 80-003FW			
	3/4" = 80-013FW			
	F 819 F-FE DT Iron	8x25 Filler Wire iron grade	n/a	n/a
	1/2" = 80-011IRONFW	natural fiber core		
5/8" = 80-012IRONFW				
3/4" = 80-013IRONFW-K				

Other imperial diameters are available.

The goal of the suggested hoist rope guidelines is to achieve maximum rope service life and minimum rope elongation. The guidelines for hoist rope are based on Rise/Travel and apply to standard 1:1 overhead machine installations only unless otherwise indicated. Other machine arrangements should be discussed with your Gustav Wolf representative prior to ordering.

It is strongly recommended that the sheaves of existing elevators be carefully checked and re-grooved or replaced as necessary prior to rope replacement. The diameter of the new ropes is greater than that of the old ropes and failure to bring the sheave grooves into the machine manufacturer's specified tolerances can lead to vibration, metal shavings and other problems.

To insure maximum rope and sheave life a program of regular re-lubrication should be adopted.

Rope and sheave life will be maximized if hoist rope tension is equalized (within a 10% range) at the time of rope installation and at regular intervals thereafter

[†] Modulus of elasticity is calculated per VDI 2358-1984.

^{††} Elongation is calculated at 10% of Minimum Breaking Force (MBF).

*Actual minimum tensile strength of outer wires is 1570 N/mm² (227,800 psi).

Range of acceptable traction sheave hardness based on rope grade/tensile strength:

Wire Rope Type (see table above and other ropes in this catalog)	Minimum Tensile Strength of Outer Wires (N/mm ² • psi)	Hardness of Traction Sheave (Brinell)
F 819 W-FC DT Iron & F 819 F-FC DT Iron	680 • 100,000 (iron grade)	For governor/comp. only
F 819 S-FC DT, CompactTrac™, F 819 W-FC DT & F 819 F-FC DT	1180 • 170,000 (traction grade)	180 - 200
Metric F 819 S-FC DT (see page 55)	1370 • 198,800	200 - 230
PAWO F3, F7, F7S & F10	1570 • 227,800	220 - 240
F 819 S-FC DT EHS	1670 • 245,000 (EHS traction grade)	230 - 250

Wire Rope by Gustav Wolf

IMPERIAL DIAMETERS TO MEET ASME A17.1 / CSA B44 AND A17.6 FOR STANDARD APPLICATIONS

Hoist, hoist / governor and governor – 8 x 19 Seale with natural fiber core

Part Number	Application	Diameter inches	Grade	Right Lay	Min. Breaking Force lbf • N	Net Weight lbs/ft • kg/m
80-000-A	Hoist / Gov.	1/4	Traction	Regular	3600 • 16025	0.09 • 0.14
80-001-A	Hoist / Gov.	3/8	Traction	Regular	8200 • 36475	0.21 • 0.31
80-001EHS-A	Hoist	3/8	EHST	Regular	9900 • 44050	0.21 • 0.31
80-001EHSLL-A	Hoist	3/8	EHST	Lang	9900 • 44050	0.21 • 0.31
80-007IRON-K	Governor	7/16	Iron	Regular	5600 • 24900	0.28 • 0.42
80-002-A	Hoist / Gov.	1/2	Traction	Regular	14500 • 64500	0.36 • 0.54
80-002LL-A	Hoist	1/2	Traction	Lang	14500 • 64500	0.36 • 0.54
80-002EHS-A	Hoist	1/2	EHST	Regular	17500 • 77850	0.36 • 0.54
80-002EHSLL-A	Hoist	1/2	EHST	Lang	17500 • 77850	0.36 • 0.54
80-038-A	Hoist	9/16	Traction	Regular	18500 • 82300	0.46 • 0.68
80-038EHS-A	Hoist	9/16	EHST	Regular	22100 • 98300	0.46 • 0.68
80-003-A	Hoist / Gov.	5/8	Traction	Regular	23000 • 102300	0.58 • 0.86
80-003LL-A	Hoist	5/8	Traction	Lang	23000 • 102300	0.58 • 0.86
80-003EHS-A	Hoist	5/8	EHST	Regular	27200 • 121000	0.58 • 0.86
80-003EHSLL-A	Hoist	5/8	EHST	Lang	27200 • 121000	0.58 • 0.86
80-039-A	Hoist	11/16	Traction	Regular	27000 • 120100	0.69 • 1.03
80-039LL-A	Hoist	11/16	Traction	Lang	27000 • 120100	0.69 • 1.03
80-039EHS-A	Hoist	11/16	EHST	Regular	32800 • 145900	0.69 • 1.03
80-039EHSLL-A	Hoist	11/16	EHST	Lang	32800 • 145900	0.69 • 1.03
80-013-A	Hoist	3/4	Traction	Regular	32000 • 142350	0.82 • 1.22
80-013EHS-A	Hoist	3/4	EHST	Regular	38900 • 173025	0.82 • 1.22
80-013EHSLL-A	Hoist	3/4	EHST	Lang	38900 • 173025	0.82 • 1.22
80-040-A	Hoist	13/16	Traction	Regular	37000 • 164575	0.96 • 1.43
80-014-A	Hoist	7/8	Traction	Regular	42000 • 186825	1.11 • 1.65
80-042-A	Hoist	1	Traction	Regular	54000 • 240200	1.45 • 2.16

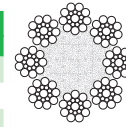

The most popular rope design in North America. Eight-strand/Seale construction with its larger outer wires better resists abrasion and wear. Dual-tensile design provides high-breaking strength without damage to sheaves with lower Brinell hardness. Available in Traction or Extra High Strength Traction (EHST) grade and Right Regular or Right Lang lay.

Governor – 8 x 19 Warrington with natural fiber core

Part Number	Application	Diameter inches	Grade	Right Lay	Min. Breaking Force lbf • N	Net Weight lbs/ft • kg/m
80-001W	Governor	3/8	Traction	Regular	8200 • 36475	0.20 • 0.30
80-010IRONW	Governor	3/8	Iron	Regular	4200 • 18675	0.20 • 0.30

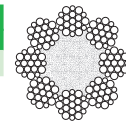

Eight-strand/Warrington construction is more flexible and makes this rope well-suited for governor applications. Available in Traction or Iron grade.

Compensation / governor and compensation – 8 x 25 Filler Wire with natural fiber core

Part Number	Application	Diameter inches	Grade	Right Lay	Min. Breaking Force lbf • N	Net Weight lbs/ft • kg/m
80-002FW	Comp./Gov.	1/2	Traction	Regular	14500 • 64500	0.36 • 0.54
80-011IRONFW	Comp./Gov.	1/2	Iron	Regular	7200 • 32025	0.36 • 0.54
80-003FW	Comp./Gov.	5/8	Traction	Regular	23000 • 102300	0.62 • 0.92
80-012IRONFW	Comp./Gov.	5/8	Iron	Regular	11200 • 49825	0.62 • 0.92
80-013FW	Compensation	3/4	Traction	Regular	32000 • 142350	0.82 • 1.22
80-013IRONFW-K	Compensation	3/4	Iron	Regular	16000 • 71175	0.82 • 1.22

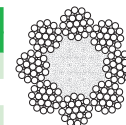

Eight-strand/Filler Wire construction with its higher wire count provides greater flexibility and makes this rope a good match for compensating applications. Available in Traction or Iron grade.

All listed Gustav Wolf wire rope is preformed, right lay with a bright (uncoated) finish. All popular items are in stock for immediate delivery. Less popular items and other diameters, strandings, constructions, grades, coatings, etc. are available by special order.



Wire Rope by Gustav Wolf

IMPERIAL DIAMETERS TO MEET ASME A17.1 / CSA B44 AND A17.6 FOR SPECIAL HOIST APPLICATIONS

Hoist PAWO F3 – 8 x 19 Seale with steel-reinforced natural fiber core

Part Number	Application	Diameter inches	Tensile Strength N/mm ²	Right Lay	Min. Breaking Force lbf • N	Net Weight lbs/ft • kg/m
80-016-A	Hoist	3/8	1570	Regular	12225 • 54400	0.24 • 0.35
80-020-A	Hoist	1/2	1570	Regular	22100 • 98300	0.42 • 0.62
80-024-A	Hoist	5/8	1570	Regular	34800 • 154800	0.66 • 0.98
80-047-A	Hoist	11/16	1570	Regular	42050 • 187000	0.81 • 1.20
80-048-A	Hoist	3/4	1570	Regular	48925 • 217600	0.93 • 1.38

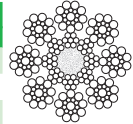

Steel-reinforced natural fiber core provides reduced stretch and cross-section deformation with higher breaking strength. Eight-strand/Seale construction with its larger outer wires increases wear resistance. Recommended for use on mid/high-rise elevators wherever Extra High Strength Traction (EHST) grade wire rope is specified to extend rope service life and reduce or eliminate the labor cost of repeated rope shortenings. PAWO F3 comes with a green surface line.

Hoist PAWO F10 – 9 x 17 or 9 x 21 Filler Wire with Independent Wire Rope Core

Part Number	Construction	Application	Diameter inches	Tensile Strength N/mm ²	Right Lay	Min. Breaking Force lbf • N	Net Weight lbs/ft • kg/m
80-104	9 x 17 Filler Wire	Hoist	3/8	1570	Regular	13600 • 60500	0.26 • 0.38
80-108	9 x 21 Filler Wire	Hoist	1/2	1570	Regular	24625 • 109500	0.46 • 0.68
80-113	9 x 21 Filler Wire	Hoist	5/8	1570	Regular	39125 • 174000	0.73 • 1.08
80-115	9 x 21 Filler Wire	Hoist	11/16	1570	Regular	46750 • 208000	0.88 • 1.30
80-117	9 x 21 Filler Wire	Hoist	3/4	1570	Regular	55050 • 244900	1.02 • 1.51

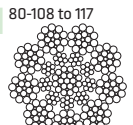
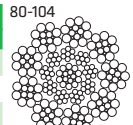

Designed specifically for demanding high-rise/high-speed applications. Full steel core (IWRC) and nine-strand/Filler Wire construction work together to achieve minimal stretch, a round cross-section, excellent flexibility, increased resistance to rope fatigue due to bending and maximized breaking strength. Recommended for use on high-rise/high-speed elevators wherever Extra High Strength Traction (EHST) grade wire rope is specified to achieve the ultimate in wire rope performance. PAWO F10 comes with a white surface line.

Hoist CompactTrac™ compacted strand – 8 x 19 Seale with natural fiber core

Part Number	Application	Diameter inches	Grade	Right Lay	Min. Breaking Force lbf • N	Net Weight lbs/ft • kg/m
80-001CSLL-A	Hoist	3/8	Traction	Lang	9400 • 41800	0.22 • 0.32
80-002CSLL-A	Hoist	1/2	Traction	Lang	17050 • 75800	0.39 • 0.58
80-003CSLL-A	Hoist	5/8	Traction	Lang	26925 • 119800	0.62 • 0.92

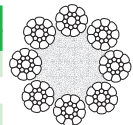

Compacted strand design of this eight-strand/Seale rope increases bending resistance. The larger contact area between ropes and sheaves reduces surface pressure and helps extend short rope service life associated with rope fatigue due to reverse bends e.g. basement machines. This is a Right Lang lay rope in Traction grade.

Hoist/governor galvanized – 8 x 19 Seale with fiber core

Part Number	Application	Diameter inches	Grade	Right Lay	Min. Breaking Force lbf • N	Net Weight lbs/ft • kg/m
80-001G-K	Hoist / Gov.	3/8	Traction	Regular	8200 • 36475	0.21 • 0.31
80-002G-A	Hoist / Gov.	1/2	Traction	Regular	14500 • 64500	0.36 • 0.54
80-003G-A	Hoist / Gov.	5/8	Traction	Regular	23000 • 102300	0.58 • 0.86

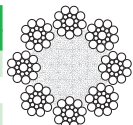

Galvanized coating on wires helps protect ropes from weather and corrosion associated with outdoor and mine elevators. This is an eight-strand/Seale construction rope in Traction grade.

Hoist and compensation / governor – 6 x 25 Filler Wire with natural fiber core

Part Number	Application	Diameter inches	Grade	Right Lay	Min. Breaking Force lbf • N	Net Weight lbs/ft • kg/m
80-075FW	Hoist	1/2	Traction	Regular	14500 • 64500	0.40 • 0.60
80-075EH5FW	Hoist	1/2	EHST	Regular	20400 • 90750	0.40 • 0.60
80-076FW-K	Hoist	5/8	Traction	Regular	23000 • 102300	0.63 • 0.94
80-076IRONFW	Comp./Gov.	5/8	Iron	Regular	12800 • 56925	0.63 • 0.94

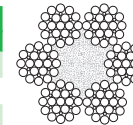

Six-strand/Filler Wire rope is less flexible than eight-strand/Filler Wire rope but it is used in a limited number of older hoist, compensating and governor applications. Available in Traction, Extra High Strength Traction (EHST) or Iron grade.

All listed Gustav Wolf wire rope is preformed, right lay with a bright (uncoated) finish (EXCEPT FOR 80-001G-K, 80-002G-A, and 80-003G-A above which are galvanized). Other diameters, strandings, constructions, grades, coatings, etc. are available by special order.

Wire Rope by Gustav Wolf

METRIC DIAMETERS TO MEET DIN EN 12385, ISO 4344, ASME A17.1 / CSA B44 AND A17.6

Metric hoist and compensation F 819 S-FC DT – 8 x 19 Seale with natural fiber core

Part Number	Application	Diameter mm	Tensile Strength N/mm ²	Right Lay	Min. Breaking Force lbf • N	Net Weight lbs/ft • kg/m
80-005-A	Hoist	8.0	1370/1770	Regular	6850 • 30500	0.15 • 0.22
80-090-A	Hoist	9.0	1370/1770	Regular	8625 • 38400	0.19 • 0.28
80-006-A	Hoist	10.0	1370/1770	Regular	10825 • 48200	0.24 • 0.35
80-007-S	Hoist	11.0	1370/1770	Regular	13125 • 58400	0.29 • 0.43
80-008-A	Hoist	12.0	1370/1770	Regular	15550 • 69200	0.34 • 0.50
80-009-A	Hoist	13.0	1370/1770	Regular	18150 • 80700	0.40 • 0.59
80-096-A	Hoist	14.0	1370/1770	Regular	20900 • 93000	0.46 • 0.68
80-097-A	Hoist/Comp.	15.0	1370/1770	Regular	24275 • 108000	0.52 • 0.78
80-098-A	Hoist/Comp.	16.0	1370/1770	Regular	27200 • 121000	0.60 • 0.89
80-099-A	Hoist/Comp.	18.0	1370/1770	Regular	34625 • 154000	0.75 • 1.11
80-091-A	Hoist/Comp.	19.0	1370/1770	Regular	38450 • 171000	0.85 • 1.26

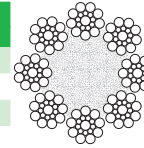

A popular metric rope design used in many standard hoist and compensating applications. Eight-strand/Seale construction with its larger outer wires better resists abrasion and wear. Dual-tensile design provides high-breaking strength without damage to sheaves with lower Brinell hardness.

Metric governor – refer to specifications below

Part Number	Construction	Application	Diameter mm	Tensile Strength N/mm ²	Right Lay	Min. Breaking Force lbf • N	Net Weight lbs/ft • kg/m
80-074	6 x 19 Seale	Governor	6.0	1770	Regular	4725 • 21000	0.09 • 0.13
80-080-S	6 x 19 Seale	Governor	6.0	1770	Regular	4725 • 21000	0.09 • 0.13
80-086	6 x 19 Seale - PAWO F3	Governor	6.0	1960	Regular	6175 • 27500	0.10 • 0.15
80-084	6 x 19 Warrington	Governor	6.5	1770	Regular	5800 • 25800	0.11 • 0.16
80-043-A	6 x 19 Seale - PAWO F3	Governor	6.5	1570	Regular	5825 • 25900	0.11 • 0.16
80-094	8 x 19 Warrington - PAWO 819W	Governor	6.5	1770	Regular	6675 • 29700	0.12 • 0.17
80-045-A	8 x 19 Seale - PAWO F3	Governor	8.0	1570	Regular	8550 • 38000	0.16 • 0.24
80-102	9 x 17 Filler Wire - PAWO F10	Governor	8.0	1570	Regular	9700 • 43200	0.18 • 0.27
80-077	8 x 19 Seale	Governor	9.5	1770	Regular	10525 • 46800	0.21 • 0.31
80-016-A	8 x 19 Seale - PAWO F3	Governor	9.5	1570	Regular	12225 • 54400	0.24 • 0.35
80-104	9 x 17 Filler Wire - PAWO F10	Governor	9.5	1570	Regular	13600 • 60500	0.26 • 0.38
80-105	9 x 17 Filler Wire - PAWO F10	Governor	10.0	1570	Regular	15100 • 67200	0.28 • 0.42

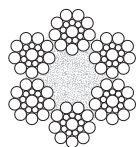

80-074 and 80-080-S are 6 x 19 Seale with synthetic fiber core. 80-080-S is galvanized.

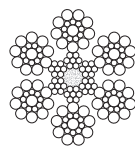

80-086 and 80-043-A are 6 x 19 PAWO F3 Seale with steel-reinforced natural fiber core.

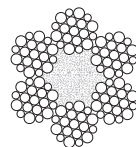

80-084 is 6 x 19 Warrington with natural fiber core.

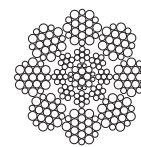

80-094 is 8 x 19 PAWO 819W Warrington with full steel core (IWRC).

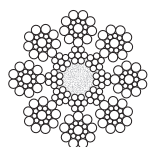

80-045-A and 80-016-A are 8 x 19 PAWO F3 Seale with steel-reinforced natural fiber core.

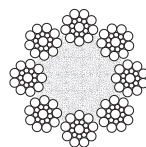

80-077 is 8 x 19 Seale with synthetic fiber core, galvanized.

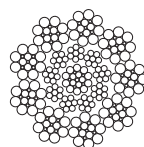

80-102, 80-104 and 80-105 are 9 x 17 PAWO F10 Filler Wire with full steel core (IWRC).

All listed Gustav Wolf wire rope is preformed, right lay with a bright (uncoated) finish (EXCEPT FOR 80-080-S and 80-077 above which are galvanized). All popular items are in stock for immediate delivery. Less popular items and other diameters, strandings, constructions, grades, coatings, etc. are available by special order.



Wire Rope by Gustav Wolf

METRIC DIAMETERS TO MEET DIN EN 12385, ISO 4344, ASME A17.1 / CSA B44 AND A17.6

Metric hoist and compensation PAWO F3 – 8 x 19 Seale with steel-reinforced natural fiber core

Part Number	Application	Diameter mm	Tensile Strength N/mm ²	Right Lay	Min. Breaking Force lbf • N	Net Weight lbs/ft • kg/m
80-045-A	Hoist	8.0	1570	Regular	8550 • 38000	0.16 • 0.24
80-015-A	Hoist	9.0	1570	Regular	10850 • 48300	0.21 • 0.31
80-017-A	Hoist	10.0	1570	Regular	13600 • 60500	0.26 • 0.39
80-018-A	Hoist	11.0	1570	Regular	16500 • 73400	0.32 • 0.47
80-019-A	Hoist	12.0	1570	Regular	19525 • 86800	0.37 • 0.55
80-021-A	Hoist	13.0	1570	Regular	23175 • 103100	0.44 • 0.65
80-022-A	Hoist	14.0	1570	Regular	26825 • 119300	0.51 • 0.75
80-023-A	Hoist/Comp.	15.0	1570	Regular	30925 • 137600	0.59 • 0.87
80-024-A	Hoist/Comp.	16.0	1570	Regular	34800 • 154800	0.66 • 0.98
80-026-A	Hoist/Comp.	18.0	1570	Regular	43525 • 193600	0.83 • 1.23
80-048-A	Hoist/Comp.	19.0	1570	Regular	48925 • 217600	0.93 • 1.38

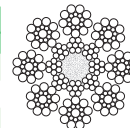

Steel-reinforced natural fiber core provides reduced stretch and cross-section deformation with higher breaking strength. Eight-strand/Seale construction with its larger outer wires increases wear resistance. PAWO F3 comes with a green surface line.

Metric hoist PAWO F7 – 8 x 19 Warrington with steel-reinforced natural fiber core

Part Number	Application	Diameter mm	Tensile Strength N/mm ²	Right Lay	Min. Breaking Force lbf • N	Net Weight lbs/ft • kg/m
80-056-A	Hoist	8.0	1570	Regular	9125 • 40600	0.18 • 0.26
80-027-A	Hoist	9.0	1570	Regular	11650 • 51800	0.22 • 0.33
80-029-A	Hoist	10.0	1570	Regular	14250 • 63400	0.27 • 0.40
80-030-A	Hoist	11.0	1570	Regular	17275 • 76800	0.33 • 0.49
80-031-A	Hoist	12.0	1570	Regular	20400 • 90700	0.38 • 0.57
80-033-A	Hoist	13.0	1570	Regular	23600 • 105000	0.45 • 0.67
80-034-A	Hoist	14.0	1570	Regular	27950 • 124300	0.53 • 0.78
80-035-A	Hoist	15.0	1570	Regular	31450 • 139900	0.60 • 0.89
80-036-A	Hoist	16.0	1570	Regular	36050 • 160400	0.69 • 1.02
80-059-A	Hoist	19.0	1570	Regular	50725 • 225600	0.96 • 1.42

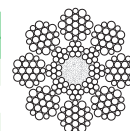

Steel-reinforced natural fiber core provides reduced stretch and cross-section deformation with higher breaking strength. More flexible eight-strand/Warrington construction resists rope fatigue due to bending in installations with numerous rope bends. PAWO F7 comes with a green surface line.

Metric hoist PAWO F7S – 8 x 19 Warrington with Independent Wire Rope Core

Part Number	Application	Diameter mm	Tensile Strength N/mm ²	Right Lay	Min. Breaking Force lbf • N	Net Weight lbs/ft • kg/m
80-056SC	Hoist	8.0	1570	Regular	10025 • 44600	0.19 • 0.28
80-027SC	Hoist	9.0	1570	Regular	12600 • 56000	0.24 • 0.36
80-029SC-S	Hoist	10.0	1570	Regular	15625 • 69500	0.30 • 0.44
80-030SC	Hoist	11.0	1570	Regular	18675 • 83100	0.35 • 0.52
80-031SC	Hoist	12.0	1570	Regular	22225 • 98900	0.42 • 0.62
80-033SC	Hoist	13.0	1570	Regular	26075 • 116000	0.49 • 0.73
80-034SC	Hoist	14.0	1570	Regular	30300 • 134800	0.58 • 0.86
80-035SC	Hoist	15.0	1570	Regular	34350 • 152800	0.65 • 0.96
80-036SC	Hoist	16.0	1570	Regular	39600 • 176100	0.74 • 1.10
80-004SC	Hoist	18.0	1570	Regular	49150 • 218600	0.93 • 1.38
80-059SC	Hoist	19.0	1570	Regular	55125 • 245200	1.04 • 1.54

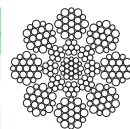

Full steel core (IWRC) reduces stretch and cross-section deformation to a minimum while maximizing breaking strength. More flexible eight-strand/Warrington construction resists rope fatigue due to bending in installations with numerous rope bends and smaller sheaves. PAWO F7S comes with a green surface line.

All listed Gustav Wolf wire rope is preformed, right lay with a bright (uncoated) finish. All popular items are in stock for immediate delivery. Less popular items and other diameters, strandings, constructions, grades, coatings, etc. are available by special order.

Wire Rope by Gustav Wolf

METRIC DIAMETERS TO MEET DIN EN 12385, ISO 4344, ASME A17.1 / CSA B44 AND A17.6

Metric hoist PAWO F10 – 9 x 17 Filler Wire with Independent Wire Rope Core

Part Number	Application	Diameter mm	Tensile Strength N/mm ²	Right Lay	Min. Breaking Force lbf • N	Net Weight lbs/ft • kg/m
80-102	Hoist	8.0	1570	Regular	9700 • 43200	0.18 • 0.27
80-103	Hoist	9.0	1570	Regular	12300 • 54800	0.23 • 0.34
80-105	Hoist	10.0	1570	Regular	15100 • 67200	0.28 • 0.42
80-106	Hoist	11.0	1570	Regular	18000 • 80200	0.34 • 0.51
80-107	Hoist	12.0	1570	Regular	21500 • 95600	0.40 • 0.60

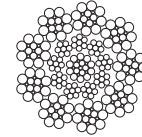

Designed specifically for demanding high-rise/high-speed applications using rope diameters of 8.0 to 12.0 mm. Full steel core (IWRC) and nine-strand/Filler Wire construction work together to achieve minimal stretch, a round cross-section, excellent flexibility, increased resistance to rope fatigue due to bending and maximized breaking strength. PAWO F10 comes with a white surface line.

Metric hoist and compensation PAWO F10 – 9 x 21 Filler Wire with Independent Wire Rope Core

Part Number	Application	Diameter mm	Tensile Strength N/mm ²	Right Lay	Min. Breaking Force lbf • N	Net Weight lbs/ft • kg/m
80-109	Hoist	13.0	1570	Regular	25500 • 113400	0.48 • 0.71
80-110	Hoist	14.0	1570	Regular	30500 • 135700	0.57 • 0.85
80-112	Hoist/Comp.	15.0	1570	Regular	34350 • 152800	0.64 • 0.95
80-113	Hoist/Comp.	16.0	1570	Regular	39125 • 174000	0.73 • 1.08
80-116	Hoist/Comp.	18.0	1570	Regular	49400 • 219700	0.92 • 1.37
80-117	Hoist/Comp.	19.0	1570	Regular	55050 • 244900	1.02 • 1.51

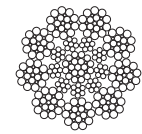

Designed specifically for demanding high-rise/high-speed applications using rope diameters of 13.0 mm and larger. Full steel core (IWRC) and nine-strand/Filler Wire construction work together to achieve minimal stretch, a round cross-section, excellent flexibility, increased resistance to rope fatigue due to bending and maximized breaking strength. PAWO F10 comes with a white surface line.

Metric hoist PAWO F4e – 8 x 19 Seale with synthetic fiber core and two 0.96 mm² (>18 AWG) conductors

Part Number	Construction	Application	Diameter mm	Tensile Strength N/mm ²	Right Lay	Min. Breaking Force lbf • N	Net Weight lbs/ft • kg/m
80-081	8 x 19 Seale (PAWO F4e)	Hoist	8.0	1770	Regular	7450 • 33200	0.17 • 0.25

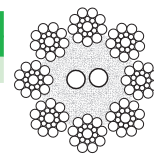

Metric hoist PAWO F5e – 6 x 19 Seale with synthetic fiber core and one 0.96 mm² (>18 AWG) conductors

Part Number	Construction	Application	Diameter mm	Tensile Strength N/mm ²	Right Lay	Min. Breaking Force lbf • N	Net Weight lbs/ft • kg/m
80-067	6 x 19 Seale (PAWO F5e)	Hoist	8.0	1770	Regular	8600 • 38200	0.16 • 0.23

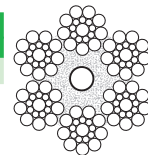

Galvanized coating on wires and 0.96 mm² (>18 AWG) electrical conductors make these six- or eight-strand/Seale ropes suitable for use on outdoor maintenance platforms and similar applications. Diameters in addition to 8.0 mm are available.

All listed Gustav Wolf wire rope is preformed, right lay with a bright (uncoated) finish (EXCEPT FOR 80-081 and 80-067 above which are galvanized). All popular items are in stock for immediate delivery. Less popular items and other diameters, strandings, constructions, grades, coatings, etc. are available by special order.



Rope Brakes

SURE STOP™ ROPE BRAKES – US PATENT 8,256,579 B2 – CERTIFIED TO CSA B44.1 / ASME A17.5

RB500 Sure Stop rope brake for 3/8 in to 1/2 in • 9.5 mm to 12.7 mm ropes

Part Number	Description
SURE STOP RB500	Sure-Stop rope brake kit for 3/8 to 1/2 inch ropes, including cable and manual
RB-JSQ8	Sure-Stop rope brake for 3/8 to 1/2 inch ropes
RB-JSQ-CABLE	Power/signal cable
RB-JSQ-MANUAL	Installation manual
AZ85618	Optional 220/120 transformer (if using 120VAC power)

RB625 Sure Stop rope brake for 1/2 in to 5/8 in • 12.7 mm to 15.9 mm ropes

Part Number	Description
SURE STOP RB625	Sure-Stop rope brake kit for 1/2 and 5/8 inch ropes, including cable and manual
RB-JSQ-CABLE	Power/signal cable
RB-JSQ-MANUAL	Installation manual
AZ85618	Optional 220/120 transformer (if using 120VAC power)



Sure Stop Rope Brake Replacement Parts

Part Number	Description
RB-BRAKE-PAD	Replacement brake pad (one) for RB500
RB-JSQ9-PAD	Replacement brake pad (one) for RB625

The Sure Stop rope brakes are a patented single-piece design. Their unique electro-mechanical operation removes the need for a separate hydraulic reset unit. Their compact footprints (16.25" x 8.63" for the RB500, 18.00" x 9.13" for the RB625) install easily in tight spaces. Power hook-up is quick and uncomplicated.

Use the RB500 for ropes 3/8 to 1/2 in. in diameter with a spread of up to 6 inches. Use the RB625 for ropes 1/2 to 5/8 in. in diameter with a spread of up to 7.75 inches.

The Sure Stop Rope Brakes are certified to CSA B44.1 / ASME A17.5 and have been verified to meet all relevant ASME A17.1 code requirements. They have also been tested and certified by NETEC (National Elevator Inspection and Testing Center) report number T3-F35-09-009.

Note: The RB500 and RB625 are normally wired for 208/220VAC but can use 120VAC with the optional transformer (p/n AZ85618). And while the units connect easily to almost every controller, in rare circumstances the wiring may need to be adapted. Draka also offers a code compliant solution for older controllers. Contact Draka for details and assistance.

Features

- Completely electronic – no need for any hydraulic piping or fittings
- Compact footprints install easily in tight spaces
- Certified to CSA B44.1-04 and ASME-A17.5-2004 (cCSAus)
- Complies with all ASME A17.1-2013 code requirements

Technical Specifications

Specification	RB500	RB625
Rope Diameter	3/8" to 1/2"	1/2" to 5/8"
Brake Pad Width	6.00"	7.75"
Maximum Rope Spread	5.25"	7.75"
1:1 Roping Rated Speed	500 ft/min	1,200 ft/min
1:1 Car Capacity*	440 to 5,500 lbs	1,900 to 4,000 lbs
1:1 Total System Mass (max)	16,000 lbs	30,000 lbs
2:1 Roping Rated Speed	350 ft/min	600 ft/min
2:1 Car Capacity (max)*	11,000 lbs	8,000 lbs
2:1 Total System Mass (max)	28,400 lbs	61,000 lbs

*Car capacities with 40 - 50% counterweight

Installation footprint RB500

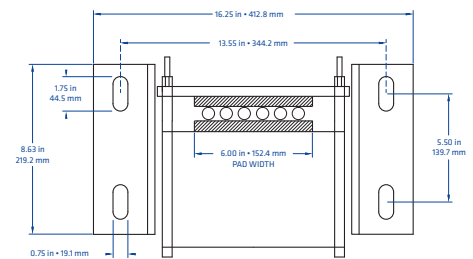

Installation footprint RB625

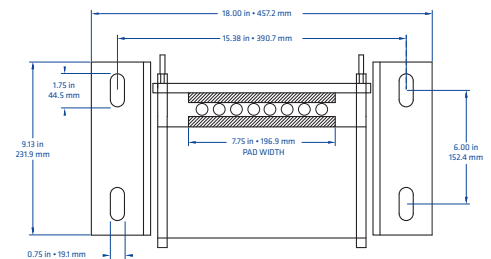

H/W Dimensions for RB500 and RB625

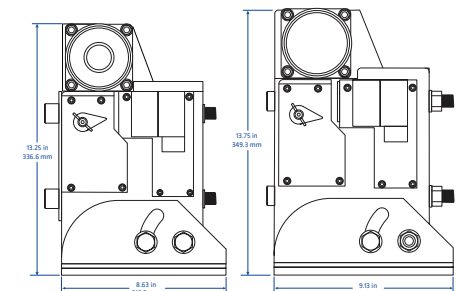

Wire Rope Wedge Sockets

TO MEET ASME A17.1 / CSA B44 • NEW YORK MEA APPROVAL #410-03-M

Wire rope wedge sockets

Part Number	Rope size inches • mm	Dim (A) nom inches • mm (+/- 3/16 • 5)	Dim (B) nom inches • mm (+/- 3/16 • 5)	Dim (C) Thread and Diameter	Usable Thread min inches • mm	Dim (D) nom inches • mm (+/- 3/8 • 10)
WSY-516-12	5/16 • 8	17-1/2 • 445	12-19/32 • 320	M12	7-7/8 • 200	8-27/32 • 225
WSY-516-18	5/16 • 8	23-3/4 • 603	18-7/8 • 480	M12	9-13/16 • 250	10-13/16 • 275
WSY-516-24	5/16 • 8	30-1/8 • 765	24-3/16 • 640	M12	15-3/4 • 400	16-23/32 • 425
WSY-38-12	3/8 • 9 to 10	17-1/2 • 445	12-19/32 • 320	M12	7-7/8 • 200	8-27/32 • 225
WSY-38-18	3/8 • 9 to 10	23-3/4 • 603	18-7/8 • 480	M12	9-13/16 • 250	10-13/16 • 275
WSY-38-24	3/8 • 9 to 10	30-1/8 • 765	24-3/16 • 640	M12	15-3/4 • 400	16-23/32 • 425
WSY-12-12-A	7/16 to 1/2 • 11 to 13	18 • 457	12-19/32 • 320	M20	7-7/8 • 200	8-27/32 • 225
WSY-12-18-B	7/16 to 1/2 • 11 to 13	24-3/8 • 619	18-7/8 • 480	M20	9-13/16 • 250	10-13/16 • 275
WSY-12-30-B	7/16 to 1/2 • 11 to 13	36-7/8 • 937	30-1/2 • 800	M20	15-3/4 • 400	16-23/32 • 425
WSY-12-36-B	7/16 to 1/2 • 11 to 13	43-1/4 • 1099	36-13/16 • 960	M20	15-3/4 • 400	16-23/32 • 425
WSY-58-12	9/16 to 5/8 • 14 to 16	19-3/4 • 502	12-19/32 • 320	M20	7-7/8 • 200	8-27/32 • 225
WSY-58-18	9/16 to 5/8 • 14 to 16	26-1/8 • 664	18-7/8 • 480	M20	9-13/16 • 250	10-13/16 • 275
WSY-58-24	9/16 to 5/8 • 14 to 16	32-3/8 • 822	24-3/16 • 640	M20	15-3/4 • 400	16-23/32 • 425
WSY-58-30	9/16 to 5/8 • 14 to 16	38-3/4 • 984	30-1/2 • 800	M20	15-3/4 • 400	16-23/32 • 425
WSY-58-36	9/16 to 5/8 • 14 to 16	45 • 1143	36-13/16 • 960	M20	15-3/4 • 400	16-23/32 • 425
WSY-34-12	11/16 to 3/4 • 17.5 to 19	21-1/4 • 540	12-19/32 • 320	M24	7-7/8 • 200	8-27/32 • 225
WSY-34-18	11/16 to 3/4 • 17.5 to 19	27-1/2 • 699	18-7/8 • 480	M24	9-13/16 • 250	10-13/16 • 275
WSY-34-24	11/16 to 3/4 • 17.5 to 19	33-3/4 • 857	24-3/16 • 640	M24	15-3/4 • 400	16-23/32 • 425
WSY-34-30	11/16 to 3/4 • 17.5 to 19	39-3/4 • 1010	30-1/2 • 800	M24	15-3/4 • 400	16-23/32 • 425
WSY-34-36	11/16 to 3/4 • 17.5 to 19	46-1/4 • 1175	36-13/16 • 960	M24	15-3/4 • 400	16-23/32 • 425

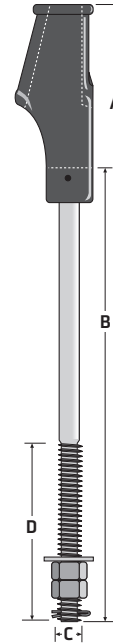

Each wedge socket consists of the socket, rod, wedge, 2 nuts, 1 washer, 1 cotter pin and 2 retaining clips.

Draka wedge sockets are tested with steel core (IWRC) wire rope and exceed ASME A17.1 Rule 2.20.9 and all other applicable safety codes.

Component Specifications:

- Socket: Cast steel ASTM-A27, Grade 60-30 stress relieved
- Rod: Rolled or forged steel ASTM 668
- Wedge: Cast steel ASTM-A27, Grade 60-30

Governor rope wedge sockets

Part Number	Description
WSY-38-GOV	3/8 • 10 mm governor rope wedge socket, includes socket, wedge and 2 retaining clips, 0.55 in • 14 mm mounting hole
WSY-12-GOV	1/2 • 13 mm governor rope wedge socket, includes socket, wedge and 2 retaining clips, 0.69 in • 17.5 mm mounting hole



Use these items to maintain wire rope. See item for location in this catalog.

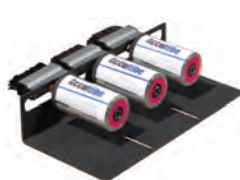



Wire Rope Wedge Sockets

ISOLATION BUSHINGS FOR WEDGE SOCKETS

Rope isolation bushing springs – assemblies and components

Part Number	Size and Description inches • mm	Spring length inches • mm	Spring O.D. inches • mm	Spring I.D. inches • mm
WS-SA-38	5/16 to 3/8 • 8 to 10 complete assembly	n/a	n/a	n/a
WS-SA-12-A	7/16 to 1/2 • 11 to 13 complete assembly	n/a	n/a	n/a
WS-SA-58	9/16 to 5/8 • 14 to 16 complete assembly	n/a	n/a	n/a
WS-SA-34	11/16 to 3/4 • 17.5 to 19 complete assembly	n/a	n/a	n/a
WS-IBUSH-38	5/16 to 3/8 • 8 to 10 bushing	n/a	n/a	n/a
WS-IBUSH-12-A	7/16 to 1/2 • 11 to 13 bushing	n/a	n/a	n/a
WS-IBUSH-58	9/16 to 5/8 • 14 to 16 bushing	n/a	n/a	n/a
WS-IBUSH-34	11/16 to 3/4 • 17.5 to 19 bushing	n/a	n/a	n/a
WS-SPR-38	5/16 to 3/8 • 8 to 10 bushing spring	4-13/16 • 122 (+/- 1/8 • 3)	1-5/16 • 33 (+/- 1/32 • 0.6)	11/16 • 17 (+/- 1/32 • 0.6)
WS-SPR-12	7/16 to 1/2 • 11 to 13 bushing spring	6-1/8 • 156 (+/- 9/64 • 3.5)	1-15/16 • 49.2 (+/- 1/32 • 0.7)	1 • 25.5 (+/- 1/32 • 0.7)
WS-SPR-58	9/16 to 5/8 • 14 to 16 bushing spring	6-7/8 • 176 (+/- 1/8 • 3)	2-1/2 • 64 (+/- 1/16 • 1.5)	1-1/4 • 32 (+/- 1/16 • 1.5)
WS-SPR-34	11/16 to 3/4 • 17.5 to 19 bushing spring	7-1/16 • 178 (+/- 5/32 • 4)	3-11/32 • 85 (+/- 3/32 • 2.5)	2-9/16 • 65 (+/- 3/32 • 2.5)
WS-BUSH-38	5/16 to 3/8 • 8 to 10 bushing washer	n/a	n/a	n/a
WS-BUSH-12-A	7/16 to 1/2 • 11 to 13 bushing washer	n/a	n/a	n/a
WS-BUSH-58	9/16 to 5/8 • 14 to 16 bushing washer	n/a	n/a	n/a
WS-BUSH-34	11/16 to 3/4 • 17.5 to 19 bushing washer	n/a	n/a	n/a
KSB-200	Isolation Bushing, for Shackle	n/a	n/a	n/a
KSB-201	Isolation Bushing, for Shackle	n/a	n/a	n/a

Isolation bushing spring assemblies include 1 spring, 3 bushings and 2 washers. They DO NOT include the wedge socket.

Springs measured when relaxed.

Component Specifications:

Socket: Cast steel ASTM-A27, Grade 60-30 stress relieved

Rod: Rolled or forged steel ASTM 668

Wedge: Cast steel ASTM-A27, Grade 60-30



Wedge socket individual components

Part Number	Size and Description inches • mm
WS-NUT-38	5/16 to 3/8 • 8 to 10 nut
WS-NUT-12	7/16 to 1/2 • 11 to 13 nut
WS-NUT-58	9/16 to 5/8 • 14 to 16 nut
WS-NUT-34	11/16 to 3/4 • 17.5 to 19 nut
WS-CPIN-38	5/16 to 3/8 • 8 to 10 cotter pin
WS-CPIN-12	7/16 to 1/2 • 11 to 13 cotter pin
WS-CPIN-58	9/16 to 5/8 • 14 to 16 cotter pin
WS-CPIN-34	11/16 to 3/4 • 17.5 to 19 cotter pin
WS-WSHR-38	5/16 to 3/8 • 8 to 10 washer
WS-WSHR-12-A	7/16 to 1/2 • 11 to 13 washer
WS-WSHR-58	9/16 to 5/8 • 14 to 16 washer
WS-WSHR-34	11/16 to 3/4 • 17.5 to 19 washer



Wedge Socket Components and Accessories

Wedge socket wedges

Part Number	Size and Description inches • mm (color)
WS-WEDGE-516	5/16 • 8 wedge insert (green)
WS-WEDGE-38	3/8 to 1/2 • 9 to 10 wedge insert (blue)
WS-WEDGE-12-A	7/16 to 1/2 • 11 to 13 (black)
WS-WEDGE-58	9/16 to 5/8 • 14 to 16 wedge insert (red)
WS-WEDGE-34	11/16 to 3/4 • 17.5 to 19 wedge insert (yellow)

Wedge: Cast steel ASTM-A27, Grade 60-30

These wedges are for use only in Draka wedge sockets.



Wedge socket retaining clips

Part Number	Size and Description inches • mm
WS-CLIP-38	5/16 to 3/8 • 8 to 10 rope retaining clip
WS-CLIP-1258	7/16 to 5/8 • 11 to 16 rope retaining clip
WS-CLIP-34	11/16 to 3/4 • 17.5 to 19 rope retaining clip



Pulling grips – galvanized steel with rotating eye

Part Number	For Wire Rope Diameters	Weave length	MBL kN
033-02-016	6.3 - 12.4 mm	660 mm	20.5 kN
033-02-018	2.7 - 18.8 mm	810 mm	44.4 kN
033-02-044	6.3 - 12.4 mm	660 mm	20.5 kN
033-02-046	2.7 - 18.8 mm	810 mm	44.4 kN



Use these items to maintain wire rope. See item for location in this catalog.

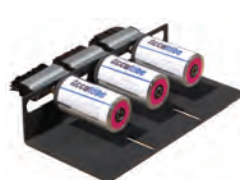



Wire Rope Accessories

Reeving splices

Part Number	Color Code	For Rope Size inches	Length inches	Rod Diameter inches	Max. Load lbs
RS-2103	Yellow	3/8	22	.051	300
RS-2105	Orange	1/2	29	.070	2000
RS-2107	Black	5/8	36	.086	2000

Reeving splices are provided three to a package. Use only once, then discard. Use ONLY for right lay ropes. Other sizes are available.



Cable bands

Part Number	Description	Suggested Buy Sold Individually or in Packaging
WR-CB-38	Cable bands for 3/8 in. rope	50
WR-CB-12	Cable bands for 1/2 in. rope	50
WR-CB-58	Cable bands for 5/8 in. rope	50



Wire rope clips - malleable iron

Part Number	Description
79-107	1/8 in. wire rope clip
79-114	3/16 in. wire rope clip
79-122	1/4 in. wire rope clip
79-123	3/8 in. wire rope clip
79-126	1/2 in. wire rope clip
79-127	5/8 in. wire rope clip

DO NOT use for hoisting applications.



Selector / hoistway door relating cable - preformed, flexible, zinc-coated

Part Number	Size inches	Stranding	MBL lbs	Cable Weight lbs/kft
MISS-300	1/8	7 x 7	480	7.5
MISS-300A	3/32	7 x 7	920	16
040216	5/32	7 x 19	2,800	45
040220	3/16	7 x 19	4,200	65
040225	1/4	7 x 19	7,000	110

DO NOT use selector / hoistway door relating cable for hoisting applications.



Use these items to maintain wire rope. See item for location in this catalog.

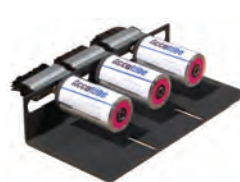

Wire Rope Lubrication

Acculube™ automatic rope lubricator and cleaner kit

Part Number	Description
ACCULUBE 200	Automatic rope lubricator/cleaner kit, with two brushes (210 mm • 8.25 inch span), bracket and reservoirs filled with DrakaLube wire rope treatment
ACCULUBE 300	Automatic rope lubricator/cleaner kit, with three brushes (300 mm • 11.8 inch span), bracket and reservoirs filled with DrakaLube wire rope treatment
SLX125 DRAKALUBE	Replacement lubricator reservoir, filled with DrakaLube
2036	One replacement 70 mm • 2.75 inch brush for Acculube 200
2037	One replacement 100 mm • 3.94 inch brush for Acculube 300
98-02-87	One steel mounting bracket
1015	One reservoir attachment nipple

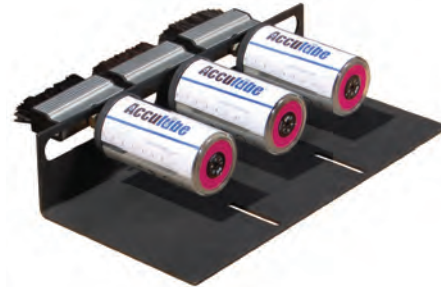

The Acculube automatic rope lubricator/cleaner is a set-and-forget way of efficiently lubricating traction ropes for up to a year.

The unit is quickly and easily assembled in the machine room. Simply install it so that the brushes are in contact with the ropes, set the lubricators to the proper time setting for your application (one year for standard indoor elevators, six months for exterior or high-contaminant environments) and walk away knowing that your hoist ropes are being consistently treated and cleaned as the elevator operates.

The lubricator reservoirs come pre-filled with our specially-formulated DrakaLube™ rope treatment. Please note that if your ropes are dirty, there will be greasy residue at the unit for a short while as the Acculube unit does its job. DO NOT attempt to refill the canisters. Contact Draka for new canisters once depleted.

Features

- Labor and time-saving way to keep ropes lubricated
- No oil spills or splashes in the machine room or the car
- Easy installation
- Constant, reliable lubricant application
- Ropes are continually cleaned by the brushes

DrakaLube™ wire rope treatment / lubricant

Part Number	Description
WR-DRAKALUBE	DrakaLube wire rope treatment / lubricant, one gallon jug

DrakaLube wire rope treatment / lubricant has been specifically formulated to fight bending stresses, high groove pressures and moisture. DrakaLube has additives that protect against corrosion, wear and most importantly, it can also displace moisture in the rope core.



Rope oilers for elevator hoist ropes, escalator chains and selector tapes

Part Number	Description
MIS-100	Automatic oiler, with 9" wick
MIS-102	Automatic oiler, with 12" wick
MIS-103	Extension bracket, for rope oiler
MIS-103A	Replacement wick, for all size rope oilers
MIS-103B	Replacement wick, 1/2" x 6 1/2" x 12"



The rope oiler lubricates by electrostatic attraction and requiring only minimal wick adjustment after installation.

Features

- Automatically lubricates rope for increased rope and sheave life
- Has an adjustable oiling rate-wick lock and wick length
- Features a top-fill external oil level indicator



Rope Tensioning System

MICELECT RTS ROPE TENSIONING SYSTEMS

RTS rope tensioning system

Part Number	Description
WR-RTS	RTS system, including control unit, power supply, USB cable for PC connection, T-handle allen wrench (for attaching sensors to rope), six (6) sensors and hard-shell case.
WR-WRS	Additional wire rope sensor and couplings for 1/6 - 5/8 in (4 - 16 mm) wire rope. Order one per rope.

The Micelect RTS (Rope Tensioning System) is a portable tool for quickly and accurately measuring the tension of elevator wire ropes. Rope tensions are quickly displayed on a backlit LCD screen.

Operating the RTS is simple: Small sensors (six are included) are attached to each wire rope using the supplied T-handle allen wrench. USB cables connect the sensors to the RTS control unit which displays rope tension in real time, allowing the tensions to be adjusted. Additional sensors are available.

Pre- and post-adjustment values are stored in the RTS memory and can be downloaded to a PC for accurate record keeping.

Features

- Portable
- Readout in both pounds and kilograms
- Accurate to within 3%
- Can measure up to 12 ropes at once with a maximum weight of 2200 lbs • 1000 kg per rope
- Both graphic and numeric displays
- Fits 5/32 to 5/8 in • 4 to 16 mm ropes
- Display languages include English, Spanish, German, Italian, French and Portuguese
- Comes with all cables, T-handled allen wrench and a hard-shell case
- Six sensors are included, can handle as many as twelve
- Stores and downloads to PC pre- and post-tensioning values
- Low battery indicator
- Factory reset switch

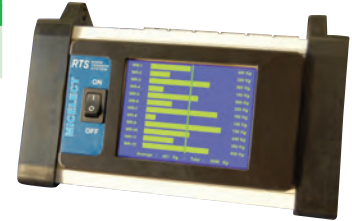

Heavy duty RTS rope tensioning system

Part Number	Description
WR-RTS-A	Heavy duty RTS system, including control unit, power supply, USB cable for PC connection, T-handle allen wrench (for attaching sensors to rope), six (6) sensors and hard-shell case.
WR-WRS-A	Additional wire rope sensor and couplings for 1/2 - 3/4 in (13 - 20 mm) wire rope. Order one per rope.

The heavy duty version of the RTS is for higher-capacity elevators with larger hoist ropes. It has all of the features of the standard RTS but with a sensor that fits 1/2 to 3/4 in • 13 to 20 mm ropes. Maximum weight per rope is 6600 lbs • 3000 kg. Spacers to fit the various rope diameters are included.

Features

- Portable
- Readout in both pounds and kilograms
- Accurate to within 3%
- Can measure up to 12 ropes at once with a maximum weight of 6600 lbs • 3000 kg per rope
- Both graphic and numeric displays
- Fits 1/2 to 3/4 in • 13 to 20 mm ropes
- Display languages include English, Spanish, German, Italian, French and Portuguese
- Comes with all cables, T-handled allen wrench and a hard-shell case
- Six sensors are included, can handle as many as twelve
- Stores and downloads to PC pre- and post-tensioning values
- Low battery indicator
- Factory reset switch



The manual Quick-Balance tension meter is also available.

Rope Tensioning Systems and Load Weighing Device Control Unit

MICELECT RTS RF AND LM3D CONTROL UNIT

RTS RF wireless rope tensioning system

Part Number	Description
WR-RTS-RF	Wireless RTS system, including control unit, recharging cable, T-handle allen wrench (for attaching sensors to rope), six (6) WR-WRF small sensors and hard-shell case.
WR-WRF	Additional wire rope sensor

The Micelect wireless RTS RF does not require a physical connection between the sensors and the control unit. Rope tensions are displayed in real time on a backlit LCD screen. Operating range is 10 meters • 33 ft. Depending on the configuration, sensors fit rope sizes from 3/16 to 7/16 in • 4 to 11 mm and 1/2 to 3/4 in • 13 to 20 mm. Parts are included for both sizes.

Like the wired RTS, small rechargeable sensors (six are included in the basic kit) are attached to individual ropes using the supplied T-handle allen wrench. The sensors communicate with the control unit via radio and are accurate to within 5% of actual load. Additional sensors are available. The control unit can receive signals from up to twelve sensors.

Pre- and post-adjustment values are stored in the RTS memory and can be downloaded to a PC for accurate record keeping.

Features

- Fits 3/16 to 3/4 in • 4 to 20 mm
- No wiring required
- Readout in both pounds and kilograms
- Accurate to within 5%
- Sensor maximum capacity is 6600 lbs • 3000 kg



LM3D control unit for load weighing devices

Part Number	Description
LM3D-EMC-CSA	Control unit for LMC with three relay outputs and one 0-20, 4-20 or 0-24 mA analog output, 115VAC
LM3D-EMC-CSA-5V	Control unit for LMC with three relay outputs and one voltage (not current) analog output, 115VAC
LM3D-EMC-CSA-220	Control unit for LMC with three relay outputs and one 0-20, 4-20 or 0-24 mA analog output, 220VAC
LM3D-EMC-CSA-POD	Control unit for LMC - same features as LM3D-EMC-CSA-220 but configured to operate with systems having a pre-opening doors option

The LM3D control unit is the brain of the Micelect LMC family and others. The LM3D relays indicate "presence," "full" and "overload" conditions to trigger appropriate controller response. The presence relay can be used to eliminate nuisance calls. A cab display that shows overload condition is available as an option (see below). Integrated software automatically corrects for increases in load caused by compensating cable or chain.

For the LM3D unit, choose either digital or analog (0-20 mA, 0-24 mA, 4-20 mA) output.

Features

- Three programmable alarm values (Presence, Full Load and Overload)
- Weight is visually displayed - built-in memory saves data
- Simple programming - just four keys program all parameters



LW-WR load weighing sensors

Part Number	Description
LW-WR-SENSOR-38	WR load weighing sensor, for individual 10 mm • 3/8 in. ropes - LM3D-EMC-CSA control unit required - see above. Automatic calibration. The WR attaches to individual ropes, operating capacity of 1200 kg • 2645 lbs per rope. Up to eight WR sensors can be wired into a LM3D-EMC-CSA unit.
LW-WR-SENSOR-12	WR load weighing sensor, for individual 13 mm • 1/2 in. ropes - LM3D-EMC-CSA control unit required
LW-WR-SENSOR-58	WR load weighing sensor, for individual 16 mm • 5/8 in. ropes - LM3D-EMC-CSA control unit required

LW-WR sensors attach directly to individual ropes. Up to eight of them may be connected to the control unit at one time. LW-WR sensors require an LM3D control unit - see above.

Each sensor has a cable 6.56 ft • 2 meters in length.





Load Weighing Devices

LMC LOAD WEIGHING DEVICE - INSTALLS ACROSS ALL ROPES

LMC load weighing device



Part Number	Description
LW-LMC	Load weighing device (sensor only), for 1:1 (8,800 lbs • 4000 kg), 2:1 (17,600 lbs • 8,000 kg) or 4:1 roping (35,200 lbs • 16,000 kg) capacity (please call if higher capacity is needed), automatic calibration, accurate to within 5%. Select spacers and clamps (below) and optional cab display



The LMC intelligent wire rope sensor is a precise device for monitoring the load in traction elevators. It mounts across all hoist ropes in as little as five minutes - calibration is automatic and no test weights are required. It's perfect for both modernizations and for new installations.

The LMC requires an LM3D control unit Clamps and spacers (sold separately) are determined by the spread of the ropes. A cab display that shows overload condition is available

Features

- Operating capacity up to 35,200 lbs. for 4:1 roping (17,600 lbs. for 2:1 roping, 8,800 for 1:1 roping)
- Accurate to within 0.5%
- Fast, easy installation
- Suitable for wire ropes from 3/8 to 3/4 in. • 6 to 20 mm diameter.
- Choose either digital or analog (0-20 mA, 0-24 mA, 4-20 mA) output

Heavy duty LMC-REF load weighing device



Part Number	Description
LW-LMC-REF	LMC-style load weighing device for heavier applications for 1:1 (16,500 lbs • 7,500 kg), 2:1 (33,000 lbs • 15,000 kg) and 4:1 (66,000 • 30,000 kg) cab weight (cab weight + cargo + compensation) - Select spacers and clamps (below) Can accommodate rope spreads of up to 8-1/2 in. • 226 mm and rope diameters up to 3/4 in. • 19 mm



The Micelect LMC-REF load weighing device is designed for heavier applications, such as freight elevators or larger passenger cars. It can determine weights up to 16,500 lbs • 7,500 kg in 1:1 roping and more in 2:1 and 4:1 roping schemes. The LMC-REF is an enhancement over the standard LMC device in that it features a special humidity-resistant housing for extended life and reliability while carrying an IP65 rating.

The LMC-REF requires an LM3D control unit Clamps and spacers (sold separately) are determined by the spread of the ropes. NOTE: Test weights are not required for calibration.

Features

- Operating capacity up to 30000 kg for 4:1 roping (15000 kg for 2:1 roping)
- Fast, easy installation
- Choose either digital or analog (0-20 mA, 0-24 mA, 4-20 mA) output

Clamps for LMC and LMC-REF load weighing devices

Part Number	Description
LW-LMC-CLAMP-4	LW-LMC size 4 clamp, up to 6-1/4 in. • 160 mm of rope spread, two LW-SPACER required
LW-LMC-CLAMP-5	LW-LMC size 5 clamp, 6-3/8 to 7-3/8 in. • 161 to 188 mm of rope spread, four LW-SPACER required
LW-LMC-CLAMP-6	LW-LMC size 6 clamp, 7-1/2 to 8-1/2 in. • 189 to 226 mm of rope spread, four LW-SPACER required
LW-LMC-CLAMP-4-REF	LW-LMC-REF size 4 clamp, up to 6-1/4 in. • 160 mm of rope spread, two LW-SPACER required
LW-LMC-CLAMP-5-REF	LW-LMC-REF size 5 clamp, 6-3/8 to 7-3/8 in. • 161 to 188 mm of rope spread, four LW-SPACER required
LW-LMC-CLAMP-6-REF	LW-LMC-REF size 6 clamp, 7-1/2 to 8-1/2 in. • 189 to 226 mm of rope spread, four LW-SPACER required

Spacers for LMC and LMC-REF load weighing devices

Part Number	Description
LW-SPACER-38	Spacer for LMC, 3/8 in. • 10 mm, two required for CLAMP- and CLAMP-REF-4, four for 5 and 6
LW-SPACER-12	Spacer for LMC, 1/2 in. • 13 mm, two required for CLAMP- and CLAMP-REF-4, four for 5 and 6
LW-SPACER-58	Spacer for LMC, 5/8 in. • 16 mm, two required for CLAMP- and CLAMP-REF-4, four for 5 and 6
LW-SPACER-116	Spacer for LMC, 11/16 in. • 17.5 mm, two required for CLAMP- and CLAMP-REF-4, four for 5 and 6
LW-SPACER-34	Spacer for LMC, 3/4 in. • 19 mm, two required for CLAMP- and CLAMP-REF-4, four for 5 and 6

Load Weighing Devices

NON-WIRE ROPE WEIGHING DEVICES AND CAB DISPLAYS

Under cab sensor



Part Number	Description
LW-CAB-SENSOR	Under cab sensor, sold in multiples of 2 (4 to 16 may be used), features automatic calibration

Under cab sensors are ideal for new installations. They easily mount under the cab and are extremely accurate. They are self-calibrating and do not require test weights.

An LM3D-EMC-CSA control unit is required

Under cab sensors are not recommended for modernizations.



Belt sensor



Part Number	Description
023-4-0003	Belt sensor, for individual 1/8 in. • 3 mm belts (sensor only), attaches to individual belts, operating capacity 2645 lbs • 1200 kg per belt.
023-4-0004	Belt sensor, for individual 3/16 in. • 4.6 mm belts (sensor only), attaches to individual belts, operating capacity 2645 lbs • 1200 kg per belt.

Up to eight belt sensors can be attached to a required LM3D-EMC-CSA control unit

Test weights are presently required for calibration – automatic calibration is pending.



WR connection box

Part Number	Description
LW-CONN-BOX	WR connection box, used with the LM3D-EMC-CSA control unit, provides a clean and protected connection for cabling
LW-CABLE-CSA	CSA cable for WR connection box, connects LW-CONN-BOX to LM3D-EMC-CSA

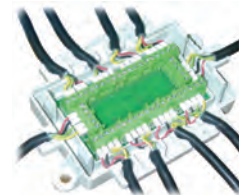

Beam sensor



Part Number	Description
023-4-0001	Cross beam-mounted load weighing device, with 6.5 ft • 2 meter cord and all necessary mounting hardware, 0-20, 4-20 or 0-24 mA analog output

This load weighing sensor mounts on the cross beams. An LM3D-EMC-CSA control unit is required. Test weights are also required for calibration.

USE ONE SENSOR when the cab capacity is 2200 lbs • 1000 kg or less,
AND when the cross beams are fixed to the same vertical beam,
AND when the cab is situated symmetrically within the car sling.

USE TWO SENSORS when the cab capacity exceeds 2200 lbs • 1000 kg,
OR when the depth of the cab is 1.4x the cab's width,
OR when the cab is NOT situated symmetrically within the car sling.



Cab displays



Part Number	Description
LW-CABDISPLA-ML	Cab display, overload shown by flashing and intermittent buzzing
LW-CABDISPLA-LPM	Cab display, load shown by progressively lit LEDs, overload by flashing and intermittent buzzing. This display cannot be used with LW-ILC3-M-ANLOG





Whisper-Flex® Compensation Cable

LIFETIME WARRANTY – PATENT NUMBER 4716989

US patent 4,716,989

LIFETIME WARRANTY

Part Number	Product Code	Cable Weight lbs/ft • kg/m	Chain Trade Size inches • mm	Cable Nom. OD inches • mm	Max. Hang Length feet • meters	Nom. Loop Width inches • mm
18-075-97	WF 075	0.75 • 1.1	3/16 • 5.5	1.05 • 27	600 • 183	22 • 540
18-010-97	WF 10	1.0 • 1.5	3/16 • 5.5	1.15 • 29	600 • 183	24 • 610
18-015-97	WF 15	1.5 • 2.2	1/4 • 7	1.36 • 35	600 • 183	24 • 610
18-020-97	WF 20	2.0 • 3.0	1/4 • 7	1.50 • 38	520 • 158	26 • 660
18-025-97	WF 25	2.5 • 3.7	5/16 • 8	1.63 • 41	600 • 183	26 • 660
18-030-97	WF 30	3.0 • 4.5	5/16 • 8	1.77 • 45	505 • 154	26 • 660
18-035-97	WF 35	3.5 • 5.2	3/8 • 10	1.91 • 49	600 • 183	27 • 690
18-040-97	WF 40	4.0 • 6.0	3/8 • 10	2.03 • 52	530 • 162	27 • 690



Whisper-Flex compensation cable provides smooth operation at temperatures of 5° F to 140° F • -15° C to +60° C and, in the US, can be used for elevators with rated speeds of no greater than 700 ft/min • 3.56 m/sec (per ASME A17.1-2013, Rule 2.21.4.2 Compensating Rope Tie-Down).

Support brackets, U-bolts, S-hooks, and heavy duty stainless steel grips specifically designed for Whisper-Flex cable must be used to ensure safe installations.

Draka Elevator damping devices are recommended to minimize cable sway for car speeds above 350 ft/min • 1.8 m/sec.

This diagram shows the approximate placement of components for a Whisper-Flex cable installation. Refer to the Compensation Cable Installation Guide for exact instructions on installation procedures.

Draka Elevator can help you determine which size of Whisper-Flex or Steadi-Flex cable to use.

- Number of hoist ropes per car
- Outer diameter of the hoist ropes
- Stranding of the hoist ropes (i.e. 8x19, 8x25...)
- Car roping (i.e. 1:1, 2:1, other...)
- Number of Whisper-Flex or Steadi-Flex cables per car,
- Length of Whisper-Flex or Steadi-Flex cable needed.

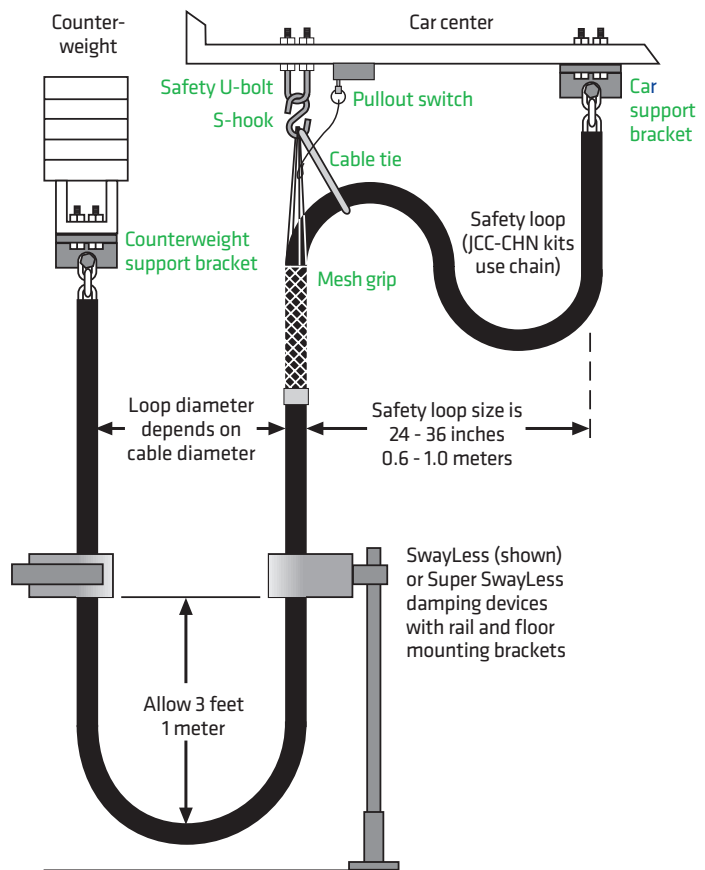

Stripping service 1-1/2 or 3-1/2 links exposed

Part Number	Description
WFSTRIP1.5L	Cable with 1-1/2 links stripped at one end
WFSTRIP3L	Cable with 3-1/2 links stripped at one end



The Whisper-Flex/Steadi-Flex strip kit makes preparing compensation cables easy.

Stedi-Flex® Compensation Cable

LIFETIME WARRANTY - USE WITH SIDE COUNTERWEIGHTS AND LONG (> 400 FT • 122 M) HANG LENGTHS

US patent 7610944 • European patent 1721859

LIFETIME WARRANTY

Part Number	Product Code	Cable Weight lbs/ft • kg/m	Chain Trade Size inches • mm	Cable Nom. OD inches • mm	Max. Hang Length feet • meters	Dynamic Loop Width* inches • mm
18-L15-97	SFC 15	1.5 • 2.2	1/4 • 7	1.39 • 35	600 • 183	46 • 1170
18-L20-97	SFC 20	2.0 • 3.0	1/4 • 7	1.56 • 40	520 • 158	47 • 1200
18-L25-97	SFC 25	2.5 • 3.7	5/16 • 8	1.67 • 42	600 • 183	48 • 1220
18-L30-97	SFC 30	3.0 • 4.5	5/16 • 8	1.82 • 46	505 • 154	49 • 1250
18-L35-97	SFC 35	3.5 • 5.2	3/8 • 10	1.91 • 49	600 • 183	50 • 1270
18-L40-97	SFC 40	4.0 • 6.0	3/8 • 10	2.04 • 52	530 • 162	50 • 1270



Stedi-Flex compensation cable is a **wide-loop version** of our standard Whisper-Flex compensation cable. Because of its wider natural loop, Stedi-Flex cable can be positioned closer to the car's centerline. This improves car balance and ride quality for installations with side counterweights and long hang lengths (over 400 ft • 122 m).

It provides smooth operation at temperatures of 23° F to 140° F • -5° C to +60° C and can be used for elevators with rated speeds up to 700 ft/min • 3.56 m/sec (per ASME A17.1 - 2013, Rule 2.214.2 Compensating Rope Tie-Down).

Support brackets, U-bolts, S-hooks and heavy duty couplings specifically designed for Stedi-Flex cable must be used to ensure safe installations. Installation hardware (JCC-XX-CHN) is recommended for use with Stedi-Flex.

Draka Elevator's Super SwayLess (p/n WF-RDD4) damping device is recommended for use with Stedi-Flex to minimize cable sway for car speeds above 350 ft/min (1.8 m/sec).

Stedi-Flex installation and the dynamic loop width

When choosing Stedi-Flex, give special consideration to the dynamic loop width. The dynamic loop width is the width of the loop when the cable is in motion and will vary with car speed, distance between support points and other factors. The static loop width will be up to 10" smaller. Position the attachment points and damping devices per the dynamic loop width in the above table. At rest, the cable should touch the damping device inside rollers - in motion, the loop will expand.

Stedi-Flex is NOT a one-for-one replacement for Whisper-Flex.

Pit dimension and possible obstructions should be considered when specifying Stedi-Flex. Counterweight and car attachment points should be spaced to match the dynamic loop width.

Refer to the Draka Compensation Cable Installation Guide for exact instructions on installation procedures.

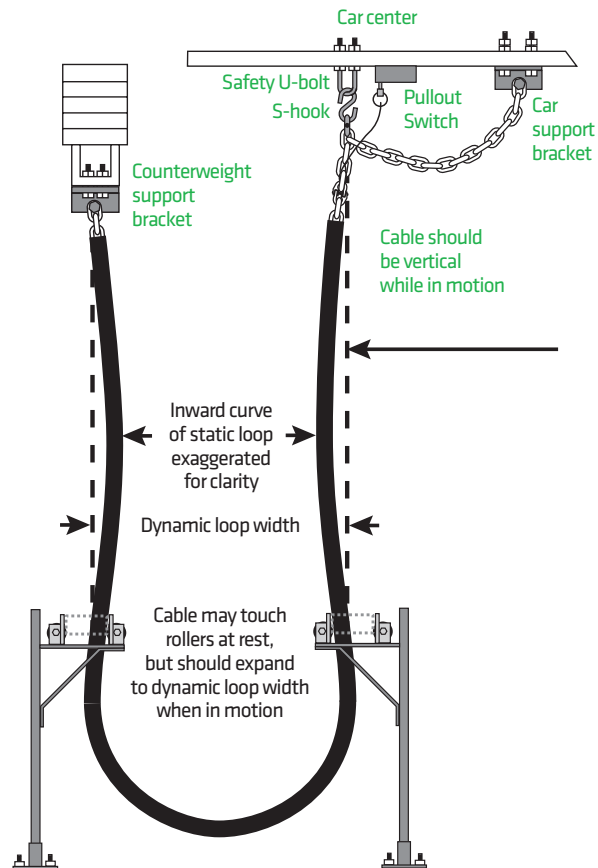

Stripping service 1-1/2 or 3-1/2 links exposed

Part Number	Description
WFSTRIP1.5L	Cable with 1-1/2 links stripped at one end
WFSTRIP3L	Cable with 3-1/2 links stripped at one end

Compensation Cable Installation Kits

INSTALLATION KITS FOR WHISPER-FLEX AND STEADI-FLEX

JCC kits for Whisper-Flex in standard pits (imperial components)

Part Number	For Use on Cables	U-bolt Size	S-hook Part No.	Mesh grip Part No.	Electrical Tape Part No.
JCC-10	WF 075 and WF 10	3/8 in.	79-011	024-20-1504	16-005
JCC-15	WF 15	3/8 in.	79-013	024-20-1470	16-005
JCC-20	WF 20	3/8 in.	79-013	024-20-1510	16-005
JCC-25	WF 25	3/8 in.	79-016	024-20-1510	16-005
JCC-30	WF 30	3/8 in.	79-016	024-20-1499	16-005
JCC-35	WF 35	3/8 in.	79-016	024-20-1499	16-005
JCC-40	WF 40	3/8 in.	79-016	024-20-1542	16-005

JCC installation kits contain two Support Brackets (includes grade 8 nuts, bolts, lockwashers and hardened washers), one U-bolt (includes nuts and washers), one S-hook, one mesh grip, electrical tape and one cable tie.

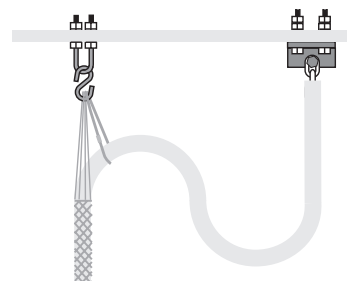

JCC-CHN kits for Steadi-Flex (and Whisper-Flex in shallow pits)

Part Number	For Use on Cables	U-bolt Size	S-hook Part No.	Coupling Quantity/Size	Chain Size
JCC-10-CHN	WF 075 WF 10	3/8 in.	79-011	(1) 9/32 in.	5/16 in.
JCC-20-CHN	WF 15 & 20 SFC 15 & 20	3/8 in.	79-013	(1) 9/32 in.	5/16 in.
JCC-30-CHN	WF 25 & 30 SFC 25 & 30	3/8 in.	79-016	(2) 9/32 in.	3/8 in.
JCC-40-CHN	WF 35 & 40 SFC 35 & 40	3/8 in.	79-016	(1) 9/32 in., (1) 3/8 in.	3/8 in.

JCC-CHN installation kits contain two Support Brackets (includes grade 8 nuts, bolts, lockwashers and hardened washers), one U-bolt (includes nuts and washers) and one S-hook. JCC-CHN kits also include one or two couplings and a 4 ft. length of chain to form the safety/adjustment loop.

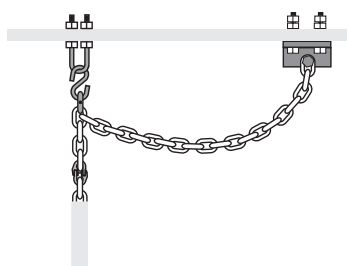

Coupling kits for shallow pits

Part Number	For Use on Compensation Cable	Chain Size	Coupling Quantity and Size
WF-20-CPLG	WF 075/SFC 15 & 20	5/16 in.	(1) 9/32 in.
WF-30-CPLG	WF/SFC 25 & 30	3/8 in.	(2) 9/32 in.
WF-40-CPLG	WF/SFC 35 & 40	3/8 in.	(1) 9/32 in., (1) 3/8 in.

Coupling kits consist of the chain and coupling(s) from the JCC-CHN installation kits. They DO NOT include mounting brackets, U-bolts or S-hooks.



IMPORTANT NOTE ON SAFETY AND WARRANTY FOR WHISPER-FLEX AND STEADI-FLEX: These components are specifically designed for the installation of Whisper-Flex/Steady-Flex cables. ONLY THE S-HOOK, MESH GRIP AND COUPLINGS ARE AVAILABLE SEPARATELY. USE OF OTHER HARDWARE (non-Draka Elevator components) COULD SERIOUSLY JEOPARDIZE THE SAFETY OF THE WHISPER-FLEX OR STEADI-FLEX CABLE INSTALLATION AND WILL VOID ANY WARRANTY.

Compensation Cable Installation Hardware

USED IN WHISPER-FLEX AND STEADI-FLEX INSTALLATION KITS

Stainless steel mesh grip – double eye/double weave/closed mesh

Part Number	For use on Cables	Eye Length inches • mm	Nom. Mesh Length inches • mm	Maximum Load lbs • kg
024-20-1504	WF 075, WF 10	12.0 • 305	14.0 • 356	1200 • 545
024-20-1470	WF 15	12.0 • 305	15.0 • 381	1640 • 745
024-20-1510	WF 20, WF 25	12.0 • 305	17.0 • 432	1660 • 755
024-20-1499	WF 30, WF 35	12.0 • 305	19.0 • 483	1800 • 818
024-20-1542	WF 40	12.0 • 305	21.0 • 533	1800 • 818



Maximum Load is based on minimum breaking strength with a 5:1 safety factor.

Support bracket – two required

Part Number	For use on Cables	Overall Size (AxBxC) in • mm	Hole D Dia. in • mm	Slot Size in • mm	Slot E to E in • mm
n/a	WF 075 WF 10	3 x 3 x 5 • 76 x 76 x 127	3/8 • 9.5	1/2 x 7/8 • 13 x 22	2-5/8 • 66.7
n/a	WF/SFC 15 to WF/SFC 30	3 x 3 x 5 • 76 x 76 x 127	7/16 • 11	1/2 x 7/8 • 13 x 22	2-5/8 • 66.7
n/a	WF/SFC 35 to WF/SFC 40	3 x 3 x 5 • 76 x 76 x 127	1/2 • 13	1/2 x 7/8 • 13 x 22	2-5/8 • 66.7

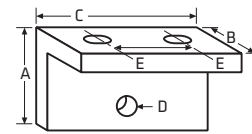

Support brackets are sold as part of the JCC kits and cannot be ordered separately.

Steel U-bolt – one required

Part Number	For use on Cables	Dim. A in • mm	Dim. B in • mm	Dim. C in • mm	Dim. T in • mm	Maximum Load* lbs • kg
n/a	WF 075, WF 10 WF/SFC 15 to WF/SFC 40	3/8 • 9.5	4-3/4 • 121	2-7/8 • 73	3 • 76	2320 • 1052

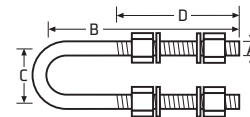

U-bolts are sold as part of the JCC kits and cannot be ordered separately.

*Maximum Load is based on minimum breaking strength with a 5:1 safety factor.

Steel S-hook – one required – available for individual replacement

Part Number	For use on Cables	Dim. A in • mm	Dim. B in • mm	Dim. C in • mm	Dim. D in • mm	Dim. E in • mm	Yield Strength lbs • kg
79-011	WF 075, WF 10	3/8 • 9.5	2-3/8 • 60	3/4 • 19	31/32 • 25	17/32 • 14	1200 • 544
79-013	WF/SFC 15 to WF/SFC 20	3/8 • 9.5	2-3/4 • 70	3/4 • 19	1-1/8 • 29	1/2 • 13	2400 • 1088
79-016	WF/SFC 25 to WF/SFC 40	17/32 • 13.5	3 • 76	1 • 25	1-1/8 • 29	19/32 • 15	4800 • 2177

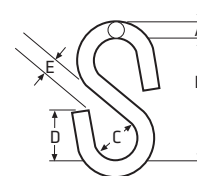

Since the S-Hook is designed to yield in order to alleviate possible damage in the event of obstruction, this item is available for replacement purposes as shown in the Draka Compensation Cable Installation Guide.

Coupling – one or two required for JCC-CHN installation

Part Number	For use on Cables	For Chain Size in • mm	Dim. A in • mm	Dim. B in • mm	Working Load Limit lbs • kg
79-116	WF 075 to 30	9/32 • 7	2-17/32 • 64	15/16 • 23	4300 • 1950
79-117	WF/SFC 35 to 40	3/8 • 10	3-7/16 • 87	2-3/8 • 60	8800 • 4000

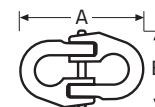

IMPORTANT NOTE ON SAFETY AND WARRANTY FOR WHISPER-FLEX AND STEADI-FLEX: These components are specifically designed for the installation of Whisper-Flex/Steady-Flex cables. ONLY THE S-HOOK, MESH GRIP AND COUPLINGS ARE AVAILABLE SEPARATELY. USE OF OTHER HARDWARE (non-Draka Elevator components) COULD SERIOUSLY JEOPARDIZE THE SAFETY OF THE WHISPER-FLEX OR STEADI-FLEX CABLE INSTALLATION AND WILL VOID ANY WARRANTY.

Compensation Cable Accessories

SWAYLESS® DAMPING DEVICE FOR WHISPER-FLEX WITH SPEEDS UP TO 500 FT/MIN • 2.54 M/SEC

US patent 6234277, Euro patent 1177150

Part Number	Overall Dimensions	Center opening	Quantity
WF-SRD	6-1/4 x 3-15/16 x 2-3/4 in.	2-3/4 in.	2
WF-SRD-1	6-1/4 x 3-15/16 x 2-3/4 in.	2-3/4 in.	1
WF-SRD-M	158 x 100 x 70 mm	70 mm	2
WF-SRD-BR	brass ring replacement	2-3/4 in. • 70 mm	1

Two SwayLess devices are required per installation. The WF-SRD-M metric version uses metric nuts and bolts for closure and attachment. Mounting brackets are sold separately (below). Use only with Whisper-Flex cables. DO NOT use with Steadi-Flex cables.

WF-SRD SwayLess damping devices are recommended for maintaining smooth operation of Whisper-Flex compensation cables for speeds of up to 500 feet/min • 2.54 m/sec.

The purpose of the WF-SRD is to dampen any oscillation or cable sway that may be generated by cable motion at higher speeds. The damping device is not usually required but can be used for speeds less than 350 feet/min • 1.78 m/sec. Proper installation requires that compensation cable should not contact the ring of the damping device when the cable is stationary. Cable must be centered within the holes.

As the car and counterweight move, the damping device keeps the compensation cable in position for optimum operation.

The WF-SRD can be used for Whisper-Flex sizes WF075 to WF30. Draka Elevator offers mounting brackets for easy installation in the elevator pit. Consult the Draka Compensation Cable Installation Guide for the installation of damping devices.

For shallow pits not allowing three feet height above cable loop, please call Draka Elevator for engineering assistance.

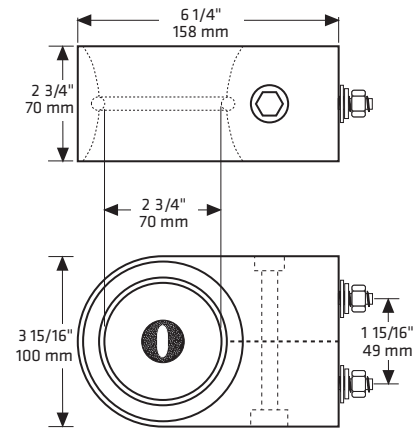

SwayLess mounting brackets

Part Number	Description
SL-FMB-48	(2) floor-mounted brackets, adjustable to 48 in. • 1.2 m height
SL-FMB-2	(2) floor-mounted brackets, adjustable to 48 in. • 1.2 m height, includes (2) SwayLess devices
SL-RMB-60	Counterweight rail-mounted bracket, adjustable to 60 in. • 1.5 m width
SL-RMB-2	Counterweight rail-mounted bracket, adjustable to 60 in. • 1.5 m width, includes (2) SwayLess devices

These brackets are specially designed to help you to quickly and easily install SwayLess devices off the counterweight guide rails and off the pit floor. They come with all the necessary hardware, including nuts, bolts and anchors.

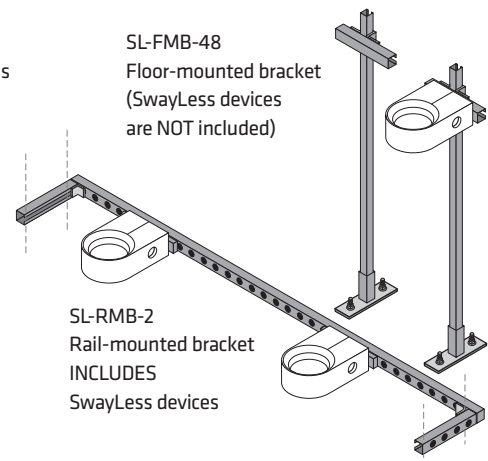

Compensation Cable Accessories

SUPER SWAYLESS® DAMPING DEVICE FOR SPEEDS UP TO 700 FT/MIN • 3.56 M/SEC

Super SwayLess with larger rollers

Part Number	Application	Overall Dimensions in • mm	Mounting Hole Dia. in • mm	Quantity
WF-RDD4	Whisper-Flex, Steadi-Flex	8 x 8 x 3.1 • 203 x 203 x 79	1/2 • 13	1
ISOLATION PADS	Replacement pads	1.5 X 1.5 • 38.1 X 38.1	1/2 • 13	4

The new Super SwayLess WF-RDD4 is designed for use on any size Whisper-Flex® or Steadi-Flex® compensating cable. It is recommended for smooth compensating cable operation for speeds up to 700 feet/min (3.56 m/sec).

Larger free-turning nylon rollers have been engineered with a bigger shaft for increased durability. The increased size of the rollers also permits quieter operation. Grease-filled high-strength bearings are built to handle the higher pressures and impact of Steadi-Flex cables.

This enhanced design uses the formed steel mounting brackets from the earlier version of the Super SwayLess for simpler installation and cushioned isolation pads to reduce vibration noise.

Two Super SwayLess devices are required per cable. Mounting brackets are sold separately (below).

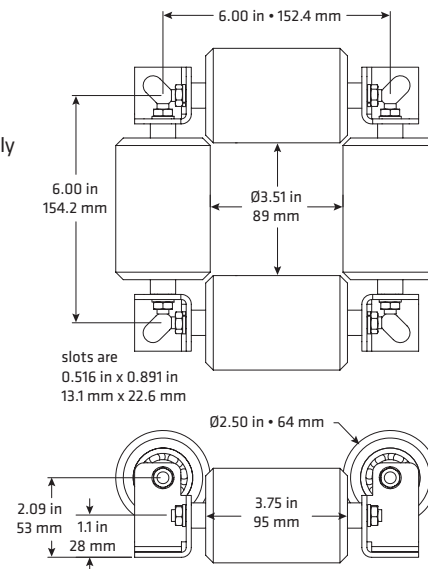

Super SwayLess mounting brackets

Part Number	Description
SSL-FMB-48	(2) floor-mounted brackets, adjustable to 48 in. • 1.2 m height, order WF-RDD4 separately
SSL-RMB-72	Counterweight rail-mounted bracket, adjustable to 72 in. • 1.8 m width, order WF-RDD4 separately
SSL-RMB-2	Counterweight rail-mounted bracket, adjustable to 72 in. • 1.8 m width, includes (2) WF-RDD4 devices

These brackets are specially designed to help you to quickly and easily install Super SwayLess devices off the counterweight guide rails and off the pit floor. They come with all the necessary hardware, including nuts, bolts and anchors.

Two Super SwayLess damping devices are required per installation. These devices are sold separately (above).

SSL-FMB-48
Floor-mounted bracket
(Super SwayLess devices are NOT included)

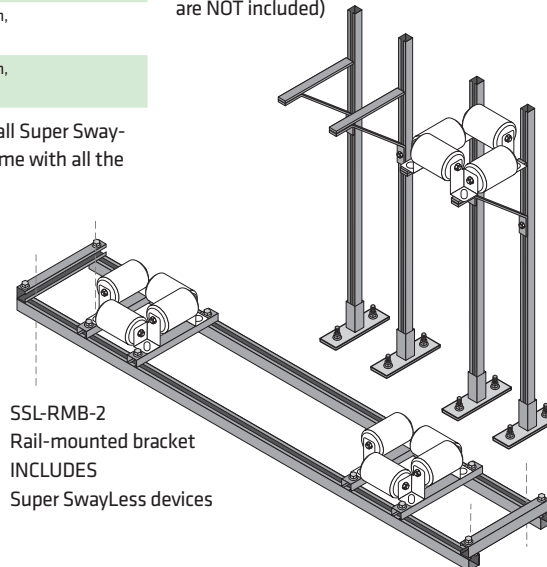

SSL-RMB-2
Rail-mounted bracket
INCLUDES
Super SwayLess devices

Compensation Cable Accessories

SHALLOWSWAYLESS® FOR SPEEDS UP TO 700 FT/MIN • 3.56 M/SEC AND PULLOUT SWITCH KIT

ShallowSwayless Damping Device

Part Number	Description
WFDD-27L	ShallowSwayless kit, for Whisper-Flex cable with maximum loop of 27 inches
WFDD-50L	ShallowSwayless kit, for Steadi-Flex cable with maximum loop of 50 inches

The ShallowSwayless is a sway reduction device for shallow pit applications where there is insufficient pit depth for SwayLess or Super SwayLess devices. It reduces compensation cable sway and oscillation in installations up to 700 ft/min • 3.56 m/sec. Two sizes are available; the 27L version is for Whisper-Flex and the 50L version is for Steadi-Flex.

NOTE: The ShallowSwayless is ONLY for shallow pit applications. To determine if a ShallowSwayless is required, note that compensating cable must remain vertical as it passes through the SwayLess or Super SwayLess damping devices. If this is not possible, even when the damping device is mounted at the compressed buffer height and the cable loop is within 6 inches of the pit floor, there is insufficient pit depth and the ShallowSwayless should be used.

The kit includes all components shown, including mounting bolts, washers and anchors.

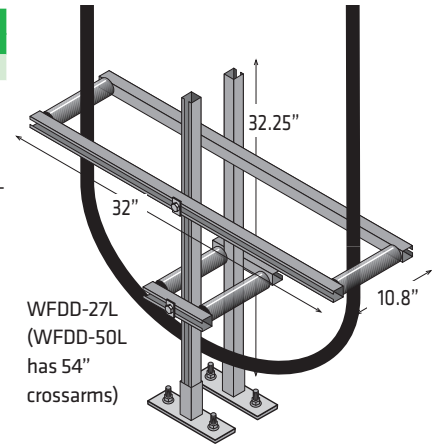

Pullout Switch and Installation Kit

Part Number	Description
36-207	Pullout switch, with flat key actuator and rotating head
WF-POSK	Pullout switch installation kit, which includes one pullout switch (#36-207), two split O-rings, two cable ties, two 4 x 40 mm pan-head screws, two 4 mm hex nuts, four 4 mm flat washers and two 4 mm lock washers.

The pullout switch is UL and C-UL listed and conforms to EN60947-5-1 and EN50047. The switch enclosure meets IP65.

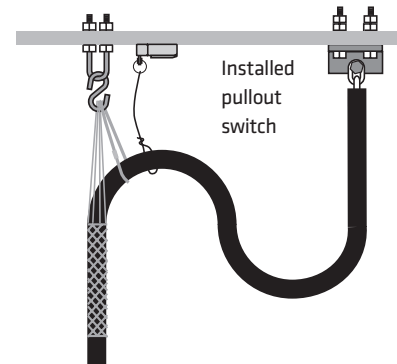
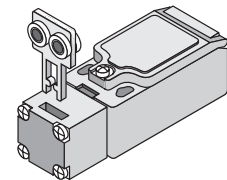

TRACTION MOD GOT YOU TIED DOWN?

THE ELECTRONIC UPGRADE FOR OLD-STYLE MECHANICAL SWITCHES

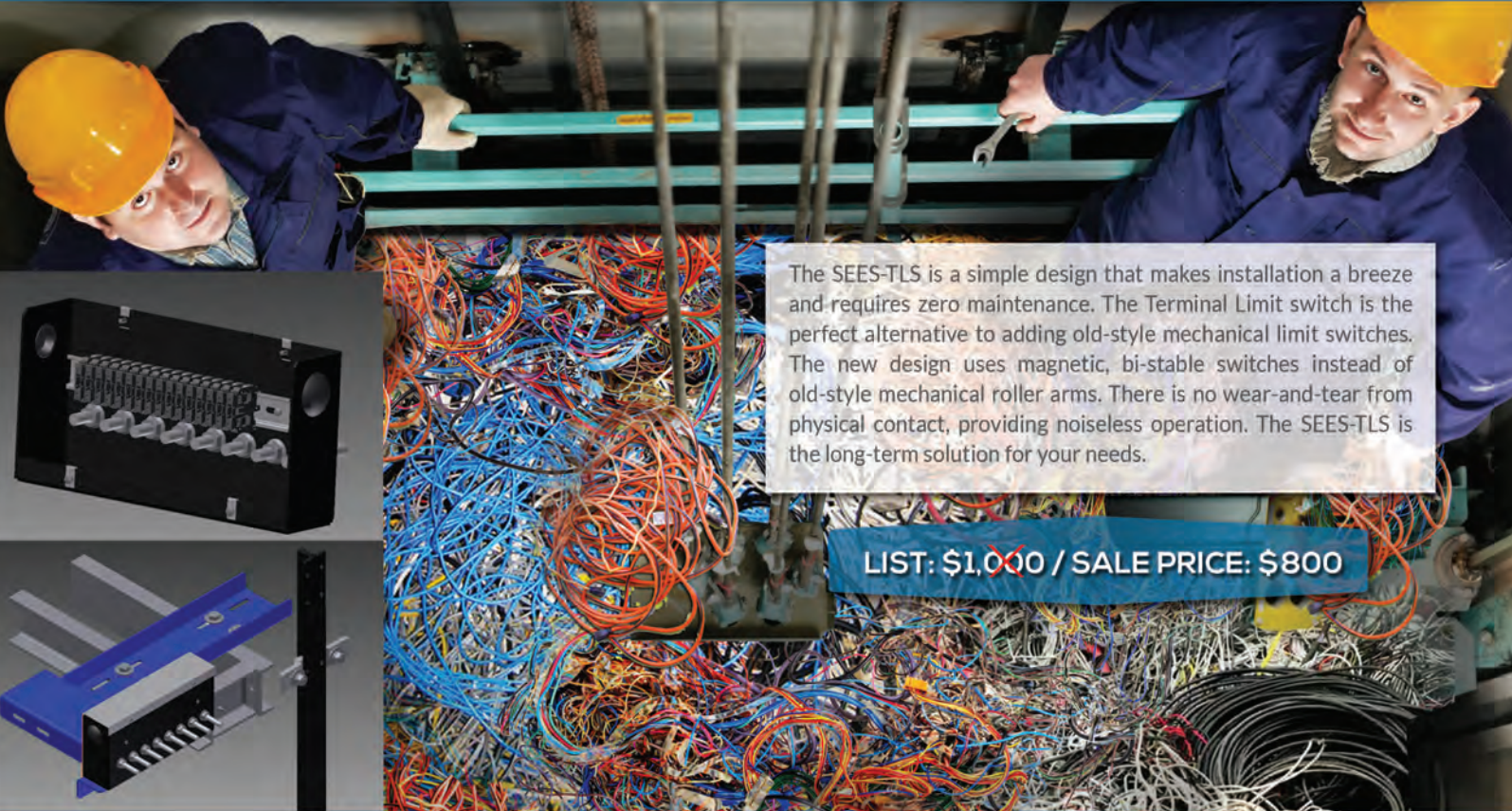

The SEES-TLS is a simple design that makes installation a breeze and requires zero maintenance. The Terminal Limit switch is the perfect alternative to adding old-style mechanical limit switches. The new design uses magnetic, bi-stable switches instead of old-style mechanical roller arms. There is no wear-and-tear from physical contact, providing noiseless operation. The SEES-TLS is the long-term solution for your needs.

LIST: \$1,000 / SALE PRICE: \$800

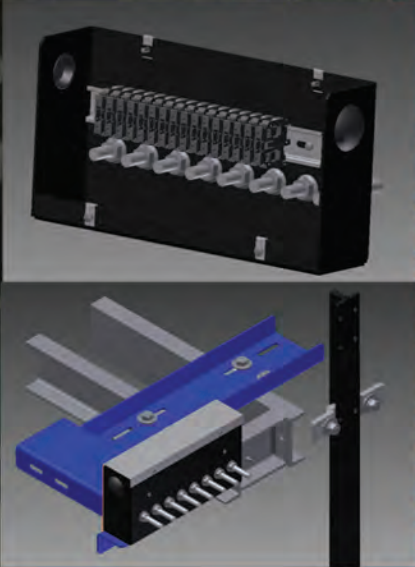

HOW IT WORKS

The switch assembly is mounted to the car top using our universal brackets system. The magnetic switches are arranged so that they interact with rail-mounted magnets in the hoistway, providing the two-way signal for the controller.

MAINTENANCE FREE

The SEES Terminal Limit Switches are tested, dependable, and have no moving parts, making them virtually maintenance-free and ultimately reducing call-backs.

EASY TO INSTALL

- Easy installation using universal bracket system
- Eliminates the need for hoistway wiring
- No adjustments after initial installation
- Reduced Installation cost
- No moving parts

Installation is a breeze and no maintenance is required!

FREE WITH PURCHASE OF SEES-TLS!



GET BOTH FREE WITH THE PURCHASE OF A SEES-TLS!!
A \$55.00 VALUE

SEES-JUMPER-001
SEES-TOOL-002

MANY USES

- Perfect for modernization projects
- Terminal slowdown
- Access limit switch
- Speed limiting
- Emergency terminal stopping

ADVANTAGES

- Easy to follow instructions
- Non-contact, noiseless operation
- Durable and accurate magnetic switching
- Best value and low cost installation

By Phone:
800.526.0026
954.971.1115

By Fax:
954.917.7337
Visit Us: www.SEEInc.com



Always Smooth Sailing

Seismic Detection Equipment

NOW RoHS COMPLIANT

Event Monitoring Device (EMD) Seismic Detector



Part Number	Description
DRK-S701-ROHS	EMD seismic detector with relays for external sensors - AC or DC power
30016	Replacement battery for DRK-S701
78-108	Fuse for DRK-S701

The DRK-S701-ROHS EMD detects and measures seismic events and signals elevator controls to take appropriate action based on their magnitude. Properly installed, the EMD will detect a potentially dangerous seismic event and alert the controller to stop the car at the nearest floor to discharge the passengers. It can also be connected to the Draka Ring-on-a-String counterweight displacement sensor.

While the EMD is highly flexible and can be configured for various applications, its three main functions are to 1) detect a seismic event and trip a latching and non-latching relay (referenced as an Alarm Event Trigger), 2) detect an internal failure and trip a latching relay (referenced as a Trouble Event Trigger), and 3) detect an event from an auxiliary sensor and trip a latching relay (referenced as an Auxiliary Event Trigger).

Features

- Economical and easy to install – Mount it, level it and turn it on
- Can also be custom programmed
- Auxiliary interface for counterweight displacement device
- Uses either 110/220VAC or 12/24VDC power
- Battery backup time approx. 18 hrs on 1 rechargeable battery and up to 36 hrs on two
- Troubleshoots itself and displays trouble codes
- Advanced dual-sensor technology prevents false alarms
- MRL safe – Remote reset and test eliminates hoistway visits

Approvals

Evaluated in accordance with ANSI/ASME A17.1 2013-10-21 and A17.5 2011-03-01. Also evaluated in accordance with CAN/CSA B44, and B44.1. The EMD is CE and RoHS compliant.



Counterweight displacement kit (“ring-on-a-string”)

Part Number	Description
CDH-R8	Counterweight displacement kit, mounts to T89 guide rails (order cable [CDH-L500, CDH-L1000 or CDH-L1500] separately)
CDH-R12	Counterweight displacement kit, mounts to T127 guide rails (order cable [CDH-L500, CDH-L1000 or CDH-L1500] separately)
CDH-L500	Cable, 500 ft • 152 m length, 1/16 in. • 1.6 mm diameter, with thimbles and clips (use for up to 250 ft. • 71 m of rise)
CDH-L1000	Cable, 1000 ft • 304 m length, 1/16 in. • 1.6 mm diameter, with thimbles and clips (use for up to 500 ft. • 152 m of rise)
CDH-L1500	Cable, 1500 ft • 456 m length, 1/16 in. • 1.6 mm diameter, with thimbles and clips (use for up to 750 ft • 223 m of rise)
040219	Cable, cut to length, does not include attachment hardware, please specify length
79-103	Thimble, for 1/8 in. • 1.6 mm cable attachment (replacement part)
79-104	Wire rope clip, for 1/16 in. • 1.6 mm cable attachment (replacement part)
36-178	Wire cutters, for cutting steel cable

The Counterweight Displacement Kit is an easily installed “ring-on-a-string” hardware kit that, when used in conjunction with a relay circuit (not included), can signal the controller if a counterweight has been displaced due to a seismic event.

Two steel cables run parallel to the counterweight guide rails and pass through a pair of eyebolts located on the counterweight. If an eyebolt contacts a cable (which indicates a counterweight displacement), the circuit is completed and the controller stops and redirects the car immediately.

Order one kit and one cable per elevator - the kit attaches to BOTH counterweight rails (as shown). Note that the kit is specified for the rail size and the cable ordered should be at least twice the rise of the elevator - the cable will be cut and installed on both rails.

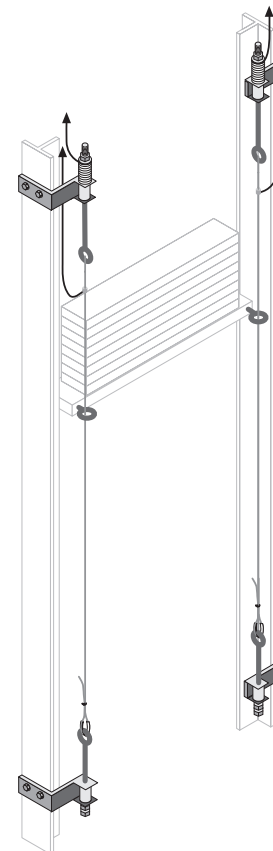

Rail Mounting Hardware

Rail brackets

Part Number	Description	Adjustable Range Distance from Wall
9743A-1	Small (1/4 in.) rail bracket assembly, with rail clips	2-1/4 to 3-1/4 in.
9743A-2	Small (1/4 in.) rail bracket assembly, with rail clips	3 to 4-3/4 in.
9750A-1	Small (1/4 in.) rail bracket assembly, without rail clips	2-1/4 to 3-1/4 in.
9750A-2	Small (1/4 in.) rail bracket assembly, without rail clips	3 to 4-3/4 in.
9745A-1	Large (5/16 in.) rail bracket assembly, with rail clips	4 to 6-3/4 in.
9745A-2	Large (5/16 in.) rail bracket assembly, with rail clips	5-3/4 to 8-1/8 in.
9745A-3	Large (5/16 in.) rail bracket assembly, with rail clips	7-1/2 to 10-1/4 in.
9749A-1	Large (5/16 in.) rail bracket assembly, without rail clips	4 to 6-3/4 in.
9749A-2	Large (5/16 in.) rail bracket assembly, without rail clips	5-3/4 to 8-1/8 in.
9749A-3	Large (5/16 in.) rail bracket assembly, without rail clips	7-1/2 to 10-1/4 in.



Rail brackets with rail clips also include locking plates for seismic areas.

Rail brackets without rail clips do not include rail clip fasteners.

Neither bracket includes wall fasteners.

12 and 15 lb. brackets use 5/8 in. fasteners.

Assemblies with rail clips for 8 lb. rail are a special order and include a correctly-sized locking plate and 1/2 in. fasteners.

Rail clips

Part Number	Description
55-012	Forged rail clip, for 8 lb. rail
55-013	Forged rail clip, for 12 lb. rail
55-014	Forged rail clip, for 15 lb. rail



Rail bracket shims

Part Number	Size	Thickness	Cutout(s)
55-020	8 x 2 in.	.030 in.	11/16 in.
55-021	8 x 2 in.	.060 in.	11/16 in.
55-022	8 x 2 in.	.105 in.	11/16 in.
55-023	9-3/8 x 2 in.	.030 in.	13/16 in.
55-024	9-3/8 x 2 in.	.060 in.	13/16 in.
55-025	9-3/8 x 2 in.	.105 in.	13/16 in.
55-026	3 x 2 in.	.015 in.	13/16 in.



Rail Mounting Hardware

CONCRETE/MASONRY INSERTS ARE DESIGNED TO ASTM A17.1

Concrete / masonry Inserts

Part Number	Description	Seismic Zone	Allowable 2-bolt Connections	Allowable Point Loads	Allowable Shear and Slip Loads*
INSERT-12	Insert, 12 in. long	0 and 1	2,000 lbs (1) load pair max.	1,370 lbs (1) point load max.	1,040* lbs per bolt (1) connection max.
INSERT-18	Insert, 18 in. long	0 and 1	2,000 lbs (1) load pair max.	1,370 lbs (2) point load max.	1,040* lbs per bolt (2) connection max.
INSERT-24	Insert, 24 in. long	0 and 1	2,000 lbs (2) load pair max.	1,370 lbs (3) point load max.	1,040* lbs per bolt (2) connection max.
INSERT-30	Insert, 30 in. long	0 and 1	2,000 lbs (2) load pair max.	1,370 lbs (3) point load max.	1,040* lbs per bolt (3) connection max.
INSERT-36	Insert, 36 in. long	0 and 1	2,000 lbs (3) load pair max.	1,370 lbs (3) point load max.	1,040* lbs per bolt (3) connection max.
INSERT-48	Insert, 48 in. long	0 and 1	2,000 lbs (4) load pair max.	1,370 lbs (4) point load max.	1,040* lbs per bolt (4) connection max.

INSERT-30



Max. load pair for standard inserts is limited to 2,000 lb. regardless of the number of load pairs used per insert.

*Shear and slip loads can be increased to 1,500 lbs/bolt if a 16 in. tall by (insert length + 10 in.) block opening is used,

Heavy duty concrete / masonry Inserts

Part Number	Description	Seismic Zone	Allowable 2-bolt Connections	Allowable Point Loads	Allowable Shear and Slip Loads*
INSERT-HD-12	Insert, 12 in. long	2 to 4	2,760 lbs (1) load pair max.	1,900 lbs (1) point load max.	1,040* lbs per bolt (1) connection max.
INSERT-HD-18	Insert, 18 in. long	2 to 4	2,760 lbs (1) load pair max.	1,900 lbs (2) point load max.	1,040* lbs per bolt (2) connection max.
INSERT-HD-24	Insert, 24 in. long	2 to 4	2,760 lbs (2) load pair max.	1,900 lbs (3) point load max.	1,040* lbs per bolt (2) connection max.
INSERT-HD-30	Insert, 30 in. long	2 to 4	2,760 lbs (2) load pair max.	1,900 lbs (3) point load max.	1,040* lbs per bolt (3) connection max.
INSERT-HD-36	Insert, 36 in. long	2 to 4	2,760 lbs (3) load pair max.	1,900 lbs (3) point load max.	1,040* lbs per bolt (3) connection max.
INSERT-HD-48	Insert, 48 in. long	2 to 4	2,760 lbs (4) load pair max.	1,900 lbs (4) point load max.	1,040* lbs per bolt (4) connection max.

INSERT-HD-30



Max. load pair for HD inserts is limited to 2,760 lb. regardless of the number of load pairs used per insert.

*Shear and slip loads can be increased to 1,500 lbs/bolt if a 16 in. tall by (insert length + 10 in.) block opening is used,

Notes for INSERTs and INSERT-HDs:

- Allowable loads at S.F. = 3.0
- Minimum required grout strength = 3,000 psi with a min. air dry density = 110 pcf.
- Min. required bolt spacing for load pairs = 6 in.
- Min. spacing between multiple load pairs = 12 in. as used on 24 in. through 48 in. inserts.
- Min. required spacing between point loads = 12 in.
- All connections require use of 1/2 in. through 3/4 in. strut nuts placed a min. of 2 in. from the end of the insert.
- Recommended bolt torques: 1/2 in. = 50 ft/lbs, 5/8 and 3/4 in. = 100 ft/lbs (3/8 in. thick anchor recommended).
- Required min. end distance from end of insert to edge of grout = 3 in. (required block opening = insert length + 6 in.).
- Required min. edge distance from centerline of insert to top and bottom edge of grout = 4 in. (8 in. tall min. block opening required).
- 5 in. min. end distance, 8 in. min. edge distance.
- Strut cross-sectional measurements are 1-5/8 x 1-5/8 in.

Insert spring nuts

Part Number	Description
INSERT-NUT-12	Spring nut, 1/2 in.
INSERT-NUT-58	Spring nut, 5/8 in.
INSERT-NUT-34	Spring nut, 3/4 in.



Deflecting sheaves/pulleys

ASSEMBLED / INCLUDES AXLE FOR KEEPER PLATES

T235 deflecting sheaves – with fixed or dismantable axles

Part Number	Sheave diameter mm	Wire rope mm	Number of grooves / groove face width mm	Sheave width mm	Max. static load kg
G320308x	320	8.0	3 / 60	120	1580
G320408x	320	8.0	4 / 77	120	2100
G320508x	320	8.0	5 / 94	144	2600
G320608x	320	8.0	6 / 111	144	3200
G360308x	360	8.0 - 9.0	3 / 60	120	1580
G360408x	360	8.0 - 9.0	4 / 77	120	2100
G360508x	360	8.0 - 9.0	5 / 94	144	2600
G360608x	360	8.0 - 9.0	6 / 111	144	3200
G400309x	400	9.0 - 10.0	3 / 60	120	1900
G400409x	400	9.0 - 10.0	4 / 77	120	2500
G400509x	400	9.0 - 10.0	5 / 94	144	3100
G400609x	400	9.0 - 10.0	6 / 111	144	3700
G450309x	450	9.0 - 11.0	3 / 60	120	2350
G450409x	450	9.0 - 11.0	4 / 77	120	3100
G450509x	450	9.0 - 11.0	5 / 94	144	3900
G450609x	450	9.0 - 11.0	6 / 111	144	4700
G500309x	500	9.0 - 12.0	3 / 60	120	2350
G500409x	500	9.0 - 12.0	4 / 77	120	3100
G500509x	500	9.0 - 12.0	5 / 94	144	3900
G500609x	500	9.0 - 12.0	6 / 111	144	4700
G550309x	550	9.0 - 11.0	3 / 60	120	2350
G550409x	550	9.0 - 11.0	4 / 77	120	3100
G550509x	550	9.0 - 11.0	5 / 94	144	3900
G550609x	550	9.0 - 11.0	6 / 111	144	4700
G550312x	550	12.0 - 13.0	3 / 94	144	3100
G550412x	550	12.0 - 13.0	4 / 94	144	4200
G550512x	550	12.0 - 13.0	5 / 111	144	5200
G550612x	550	12.0 - 13.0	6 / 130	164	6300



For FIXED AXLES, replace the 'x' in the part number with F (i.e. G550612F)

For DISMOUNTABLE AXLES, replace the 'x' in the part number with S (i.e. G550612S)

Sizes up to 750 mm diameter are available – please call for details.

Hydraulic Ball Valves and Pipe Fittings

BY GRINNELL

Grooved ball valves

Part Number	Description/Size Compare to Victaulic® 726
GRN-GBLV020	Ball valve, 2 in.
GRN-GBLV025	Ball valve, 2-1/2 in.
GRN-GBLV030	Ball valve, 3 in.
GRN-GBLV040	Ball valve, 4 in.



Elbows and fittings

Part Number	Description/Size Compare to Victaulic® 10
GRN-21015S	90° elbow, 1-1/2 in.
GRN-21020S	90° elbow, 2 in.
GRN-21025S	90° elbow, 2-1/2 in.
GRN-21030S	90° elbow, 3 in.
GRN-21040S	90° elbow, 4 in.



Threaded ball valves*

Part Number	Description/Size
TBLV-020	Threaded ball valve, 2 in.
TBLV-025	Threaded ball valve, 2-1/2 in.
TBLV-030	Threaded ball valve, 3 in.
TBLV-040	Threaded ball valve, 4 in.



Part Number	Description/Size Compare to Victaulic® 11
GRN-20120S	45° elbow, 2 in.
GRN-20125S	45° elbow, 2-1/2 in.
GRN-20130S	45° elbow, 3 in.
GRN-20140S	45° elbow, 4 in.

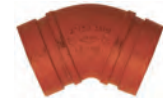

*Threaded ball valves are made by Anvil.

Flexible couplings

Part Number	Description/Size Compare to Victaulic® 77
GRN-70715TS	Flexible coupling, 1-1/2 in.
GRN-70720TS	Flexible coupling, 2 in.
GRN-70725TS	Flexible coupling, 2-1/2 in.
GRN-70730TS	Flexible coupling, 3 in.
GRN-70740TS	Flexible coupling, 4 in.



Part Number	Description/Size Compare to Victaulic® 12
GRN-31220S	22.5° elbow, 2 in.
GRN-31225S	22.5° elbow, 2-1/2 in.
GRN-31230S	22.5° elbow, 3 in.
GRN-31240S	22.5° elbow, 4 in.

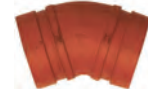

Rigid couplings

Part Number	Description/Size Compare to Victaulic® HP-70
GRN-77020TS	Rigid coupling, 2 in.
GRN-77025TS	Rigid coupling, 2-1/2 in.
GRN-77030TS	Rigid coupling, 3 in.
GRN-77040TS	Rigid coupling, 4 in.



Part Number	Description/Size Compare to Victaulic® 13
GRN-31320S	11.25° elbow, 2 in.
GRN-31325S	11.25° elbow, 2-1/2 in.
GRN-31330S	11.25° elbow, 3 in.
GRN-31340S	11.25° elbow, 4 in.

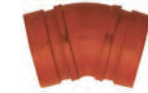

Concentric reducer

Part Number	Description/Size
GRN-72858	Concentric reducer, goes from 2.5 in. to 2 in.



Part Number	Description/Size Compare to Victaulic® 20
GRN-21920S	Tee, 2 in.
GRN-21925S	Tee, 2-1/2 in.
GRN-21930S	Tee, 3 in.
GRN-21940S	Tee, 4 in.



Universal go/no-go gauge

Part Number	Description/Size
GRN-4044	Go/no-go gauge

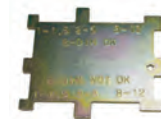

Part Number	Description/Size Compare to Victaulic® 60
GRN-26020S	End cap, 2 in.
GRN-26025S	End cap, 2-1/2 in.
GRN-26030S	End cap, 3 in.
GRN-26040S	End cap, 4 in.



Part Number	Description/Size
MIS-173B	Nitrile gasket, 1-1/2 in.
MIS-173A	Nitrile gasket, 2 in.
MIS-173	Nitrile gasket, 2-1/2 in.
MIS-174	Nitrile gasket, 3 in.
GRN-40NITRILS	Nitrile gasket, 4 in.



Victaulic® is a registered trademark of the Victaulic Corporation.
There is no relationship between the Victaulic Corporation and

Hydraulic Accessories

ISOLATION COUPLINGS, MUFFLERS, RUPTURE VALVES AND CUSHION CLAMPS

Isolation couplings by EECO

Part Number	Description	Size
2060A-1	Grooved to grooved coupling	2 in.
2060A-2	Grooved to National Pipe Thread (NPT) coupling	2 in.
2060A-3	NPT to NPT coupling	2 in.
2070A-1	Grooved to grooved coupling	2-1/2 in.
2070A-2	Grooved to NPT coupling	2-1/2 in.
2070A-3	NPT to NPT coupling	2-1/2 in.
2080A-1	Grooved to grooved coupling	3 in.
2080A-2	Grooved to NPT coupling	3 in.
2080A-3	NPT to NPT coupling	3 in.



Mufflers by EECO

Part Number	Description	Size/Throughput
MU-2000-1	Muffler, 2 in. GRV to 2 in. GRV	6-5/8 in. OD, 11-3/4 in. long / 185 GPM max.
MU-2000-2	Muffler, 2 in. GRV to 2 in. NPT	6-5/8 in. OD, 11-3/4 in. long / 185 GPM max.
MU-2000-4	Muffler, 2 in. NPT to 2 in. NPT	6-5/8 in. OD, 11-3/4 in. long / 185 GPM max.
MU-2500-1	Muffler, 2-1/2 in. GRV to 2-1/2 in. GRV	8-5/8 in. OD, 11-3/4 in. long / 260 GPM max.
MU-2500-2	Muffler, 2-1/2 in. GRV to 2-1/2 in. NPT	8-5/8 in. OD, 11-3/4 in. long / 260 GPM max.
MU-2500-4	Muffler, 2-1/2 in. NPT to 2-1/2 in. NPT	8-5/8 in. OD, 11-3/4 in. long / 260 GPM max.
MU-2500-5	Muffler, 2-1/2 in. NPT to 3 in. GRV	8-5/8 in. OD, 11-3/4 in. long / 260 GPM max.
MU-2500-6	Muffler, 2-1/2 in. GRV to 3 in. GRV	8-5/8 in. OD, 11-3/4 in. long / 260 GPM max.
MU-3000-1	Muffler, 3 in. GRV to 3 in. GRV	8-5/8 in. OD, 11-3/4 in. long / 350 GPM max.
MU-3000-2	Muffler, 3 in. GRV to 3 in. NPT	8-5/8 in. OD, 11-3/4 in. long / 350 GPM max.
MU-3000-3	Muffler, 3 in. NPT to 3 in. NPT	8-5/8 in. OD, 11-3/4 in. long / 350 GPM max.



Rupture valves

Part Number	Description	Flow Rate/Max. Pressure
PRV-2-NPT	Pipe rupture valve, 2 in. - NPT	111 to 208 GPM / 1200 PSI
PRV-2-GRV	Pipe rupture valve, 2 in. - Grooved	111 to 208 GPM / 1200 PSI
PRV-25-NPT	Pipe rupture valve, 2-1/2 in. - NPT	209 to 318 GPM / 1000 PSI
PRV-25-GRV	Pipe rupture valve, 2-1/2 in. - Grooved	209 to 318 GPM / 1000 PSI
PRV-3-NPT	Pipe rupture valve, 3 in. - NPT	319 to 546 GPM / 800 PSI
PRV-3-GRV	Pipe rupture valve, 3 in. - Grooved	319 to 546 GPM / 800 PSI



Cushion clamps for hydraulic pipe

Part Number	Description	Pipe Trade Size
FS-1400P-200	Cushion clamp	2
FS-1400P-250	Cushion clamp	2-1/2
FS-1400P-300	Cushion clamp	3
FS-1400P-400	Cushion clamp	4



Silencer by Minnesota Elevator

Part Number	Description
MEI-19317	Silencer, 220 max. GPM, fits 2 x 2 in. grooved coupling 13-1/4 L x 4-5/8 in. O.D., 28 lbs, rated to 1000 PSI
MEI-19319	Silencer, 360 max. GPM, fits 2-1/2 x 3 in. grooved coupling, 13-1/4 L x 4-5/8 in. O.D., 28 lbs, rated to 1000 PSI



The MEI Silencer uses a bladder system with air pressure to reduce excessive noise that may be generated by a hydraulic system.

Hydraulic Accessories

OIL COOLER, SILENCERS, PRESSURE SENSORS AND PIPE STANDS

Oil cooler by Minnesota Elevator – components CSA certified

Part Number	Description
MEI-10248	Oil cooler, with filter

The MEI Oil Cooler reduces the oil temperature by nearly 40° F • 22° C, (depending on site conditions). The cooler also filters the oil which results in smoother stops and starts, improved levelling and extended component life. The oil cooler can be mounted directly or remotely.

Remote installations should not exceed 110 ft • 33.5 m horizontal or 55 ft • 17.5 m vertical from tank.

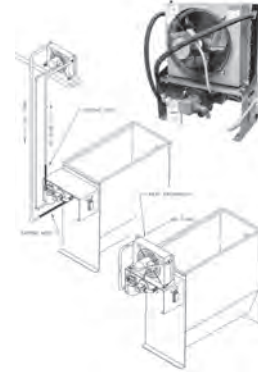

Hydraulic pressure sensor by Micelect – cCSAus certified



Part Number	Description
LW-SPB-M-NPT-STD	Hydraulic pressure sensor, with 2 relay outputs, includes 1/4 in. NPT female fitting, automatic calibration - no test weights required, 24 - 48VAC, 2 relays, 250V@3A
LW-SPB-M-NPT-020	Hydraulic pressure sensor, like above but with 0-20 mA analog output

The Micelect LW-SPB hydraulic pressure sensors mount to the hydraulic power unit. Pressure measurements are converted into outputs. Actual pressure can be displayed as well. The sensor automatically calibrates - no test weights are required.

Roller guides are required at least on top or on bottom of cab.



Pipe stand – adjustable to 22" height

Part Number	Description	Pipe Trade Size
PIPE22-15	Pipe stand	1-1/2
PIPE22-2	Pipe stand	2
PIPE22-2.5	Pipe stand	2-1/2
PIPE22-3	Pipe stand	3

Pipe stand – adjustable for 1 to 4 inch pipes

Part Number	Description
GRN-4031	Pipe stand, accomodating 1" - 4" (25mm - 100mm) pipe; 600 lbs (272.2 kg) max, 22" (559mm) diameter base with 2" (50mm) column, saddle has two roller bar bearings for free rotation of the pipe, and absorbs vibration to ensure a smooth, uniform groove. Saddle height is adjustable over a 10" (250mm) range.

Roll groover

Part Number	Description
GRN-1039	Manual roll groover with hand crank, Schedule 40 capacity 1-1/4 to 6 inches, copper tube capacity 2 - 8 inches, can be used with Rigid® Model 300 without gearbox removal



Tools

JACKET STRIPPERS

FlexiPeeler™ round cable stripper

Part Number	Description
36-060	FlexiPeeler, for cable dia. 0.2 to 1.5 in. • 4.5 to 40 mm, one replacement blade included
36-061	Replacement blade

The FlexiPeeler precisely cuts a jacket with rotary, straight lengthwise and spiral cuts. Two quickly switched hooks permit its use on cables from 0.2 in. to 1.5 in. • 4.5 to 40 mm in diameter. Cut depth is adjustable. A replacement blade is included in the handle.



Super Peeler round cable stripper

Part Number	Description
36-146	Super Peeler, for cable dia. 3/4 to 1-1/4 in. • 19 to 32 mm
36-147	Super Peeler, for cable dia. 1-1/4 to 2 in. • 32 to 51 mm
36-148	Replacement blade, for both versions

Easy to calibrate and use, these unique cable 'peelers' allow you to precisely score round traveling cable jackets for fast removal without nicking the conductors underneath. By turning the dial, the spring-loaded blade on either stripper can be adjusted to a scoring depth of .05 to .14 in • 1.27 to 3.56 mm.



FCJ flat cable stripper

Part Number	Description
36-135-M1	FCJ Stripper
36-138	Replacement blades, package of six
36-139-M1	Replacement blade guide

Faster and safer than the utility knife it replaces, the FCJ stripper makes easy work of stripping jackets from flat cables. A rigid, ergonomic handle fits the worker's hand and protects it from cuts and skinned knuckles. The blade is housed in an L-shaped hardened steel guide that eases the stripping operation while keeping the blade and fingers from touching. Two extra blades are included in the handle.



Sock Slicer™

Part Number	Description
36-177	Sock Slicer braid cutter

The Sock Slicer braid cutter is specially designed for fast, easy braid removal. The protected blade cannot nick conductors and can be repositioned / rotated for optimum sharpness should it ever get dull.



Tools

INSULATION STRIPPERS

QuickStrip

Part Number	Description
017-05-0001	Draka QuickStrip wire stripper, self-adjusting, 017-05-0002 'black' cartridge included
017-05-0002	'Black' blade cartridge, straight blade, for PVC insulation, 34 - 8 AWG
017-05-0004	'Red' blade cartridge, straight blade, for PVC insulation, 10 - 5 AWG
017-05-0003	'Blue' blade cartridge, V-blade, for PTFE (Teflon) insulation, 28 - 12 AWG

The Draka QuickStrip is a self-adjusting stripping tool that is lightweight but strong and is equally suitable for both high volume production and field usage. It permits fine insulation to be stripped without damaging the conductors. The ergonomic design ensures comfort in the shop or field.



Automatic wire stripper

Part Number	Description
36-219	Automatic wire stripper, for 22 to 10 AWG
36-220	Replacement blades, one pair



Manual wire stripper

Part Number	Description
37-177	Wire stripper, for 26 to 16 AWG



Tools

CRIMPERS AND CUTTERS

Draka QuickCrimp

Part Number	Description
017-5-0005	QuickCrimp, ratchet-style, tool only (no dies)
017-5-0006	Die set, for 26 - 22 AWG and 12 - 10 AWG green and yellow insulated terminals and splices
017-5-0007	Die set, for 22 - 14 AWG red and blue insulated terminals and splices
017-5-0008	Die set, for 22 - 10 AWG non-insulated terminals, lugs and splices
017-5-0009	Die set, for 24 - 8 AWG insulated and non-insulated wire ferrules
017-5-0010	Die set, for 26 - 12 AWG power contacts

The Draka QuickCrimp handles a wide range of crimping applications. Interchangeable dies enable the user to tackle wire sizes from 26 to 8 AWG with one tool. Ergonomic design provides comfort while rugged construction delivers durability.



Crimping tool

Part Number	Description
36-097	Crimping tool, for bare or insulated terminals and splices for wire sizes 22 - 10 AWG



Roto-Flex conduit cutter

Part Number	Description
36-217	Flex conduit cutter, for 3/8 to 3/4 in. flex conduit and 14-2 to 2-4 MC cable
36-218	Replacement blade, one



Steel core cutter

Part Number	Description
36-178	Steel core cutter

High-leverage cutters with Swiss-made carbide steel blades that make quick work of the steel support cable found in traveling cables. Plastic-coated handles for comfort and gripability. Blades lock in a closed position for better fit in a tool belt.



Tools

WIRE ROPE CUTTING AND MEASURING TOOLS

Impact cutter

Part Number	Description
WR-IMPACT	Impact-style wire rope cutter, Morse-Starrett 101, for wire rope sizes up to 3/4 in. • 19 mm



Hydraulic cutter

Part Number	Description
WR-HYDRAULIC	Hydraulic-style wire rope cutter, Morse-Starrett W-075, for wire rope sizes up to 3/4 in. • 19 mm



Ratchet cutter

Part Number	Description
WR-RATCHET	Ratchet-style wire rope cutter, Cooper Tools 8690 TN, for wire rope sizes up to 3/4 in. • 19 mm



Rope gauge

Part Number	Description
WR-MT	Wire rope measuring gauge, for imperial sizes, go/no go style, 3/8, 7/16, 1/2, 9/16, 5/8, 11/16 and 3/4 in.
WR-MT-METRIC	Wire rope measuring gauge, for metric sizes, go/no go style, 6, 8, 10, 11, 12, 13, 16 and 19 mm



If the rope fits in the groove, or if a rope with rouge fits the stepped groove, retire the rope. Measurements based on ASME 17.6. Machined aluminum.

Quick-Balance tension meter

Part Number	Description
WR-QBTM-2	Wire rope tension measurement meter, 10000 lb/45 kN/4500 kg range

The Quick-Balance tension meter can be attached to a rope, used to measure tension and removed in just seconds. The digital load cell assures accuracy of up to +/- 3%. The meter is shipped from the factory with 1/2 in. • 12.7 mm, 9/16 in. • 14 mm and 5/8 in. • 16 mm diameter calibrations (other diameters are available by special order). The included sheave set accommodates wire diameters of 1/4 in. to 3/4 in.



Digital caliper with case

Part Number	Description
WR-CALIPER-C	Digital wire rope caliper, dual range (imperial and metric scales), includes special jaws for ease of use and rigid case



Tools

COMPENSATION CABLE STRIPPING KITS, SWAGING TOOLS AND PUNCHES, CONDUIT BENDERS, WAGO TOOLS

Whisper-Flex and Steadi-Flex strip kit

Part Number	Description
WF-STRP	Strip kit, with instructions

This kit includes angle mounting bracket (already assembled), clamps, nippers, utility knife, cable jacket cutter, hacksaw and gloves for use in preparing the end of all Draka compensation cables. Carrying case included. Other tools required but not included are 3/4 in. wrench and flathead screwdriver.



Swaging tool, ferrules and stops

Part Number	Description
36-143	Swaging tool
36-145	3/32 in. • 2 mm ferrules, 2 ferrules/2 stops
36-144	1/8 in. • 3 mm ferrules, 2 ferrules/2 stops

This bolt cutter-style swaging tool offers improved leverage and greater speed combined with economical durability. The strong forged jaws crimps ferrules on wire rope up to 1/8 in. • 3 mm diameter.



Greenlee knockout punches

Part Number	Description
36-008	1/2 to 1-1/4, one per package
36-009	1-1/2 to 2, one per package



Conduit bender

Part Number	Description
36-002	Conduit bender with handle, for 1/2 in. EMT, 4 in. inside bending radius
36-001	Conduit bender with handle, for 3/4 in. EMT, 5 in. inside bending radius
36-000	Conduit bender with handle, for 1 in. EMT, 6 in. inside bending radius
36-214	Conduit bender with handle, for 1-1/4 in. EMT, 9 in. inside bending radius

Conduit benders have aluminum construction for easy handling. They have a precision-located degree scale, star, arrow and rim notch for perfect bends every time. Markings are raised and cast into bender body on both sides for easy visibility. Grooved internal hook surface helps prevent conduit from slipping. Flat hook surface provides stable starting point.



WAGO tools

Part Number	Description
210-720	Screwdriver, with partially insulated shaft
285-172	Universal T-tool, for use with high-current terminal blocks
210-658	Operating tool, with partially isolated shaft, blade 3.5 x 0.5 mm, particularly suitable for actuator and sensor terminal blocks



Tools

WIRE / REEL ORGANIZATION AND GUIDE RAIL ALIGNMENT

Wire caddy

Part Number	Description
36-221	Hand wire caddy



Reel roller

Part Number	Description
36-222	Reel roller, for up to 30 in. reels, 2,000 lbs. capacity, 26-1/2 L X 33-1/2 W X 4-1/2 T in., 50 lbs weight

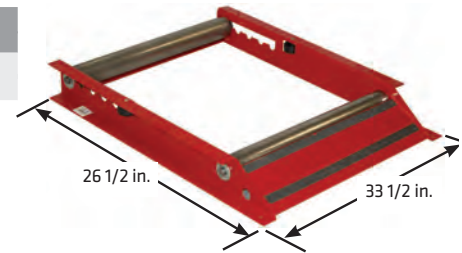

Guide rail alignment gauges

Part Number	Description
DRAKA-RAG-001	Rail alignment gauges, pair of clamp-style gauges, hard-shell case included

Draka's easy-to-use rail alignment gauges are the perfect tool for ensuring that your elevator guide rails are properly installed. Clamp the gauges to the rails directly across from each other (the clamps are adjustable depending on rail thickness). This straightens the alignment string like a plumb line. If you can see the line through the precisely-machined viewing holes, the rails are aligned. If you can't, then adjust the rails while the gauges are attached to confirm proper alignment.



Tools

DRILL BITS, SAW BLADES AND DOOR WEDGE

Drill bits

Part Number	Description
36-003	3/8 x 6 in. masonry bit
36-042	1/2 x 6 in. masonry bit
36-004	1/4 in. masonry carbide bit
36-037	1/8 in. high-speed bit
36-041	1/4 in. high-speed bit
36-014	5/16 in. high-speed bit
36-007	3/8 in. high-speed bit
36-040	#7 high-speed bit
36-039	#21 high-speed bit
36-038	#29 high-speed bit

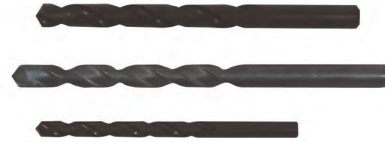

Hole saws

Part Number	Description
36-080	7/8 in. hole saw
36-084	1 in. hole saw
36-081	1-1/8 in. hole saw
36-086	1-1/4 in. hole saw
36-099	2 in. hole saw
36-047	2-1/8 in. hole saw
36-049	2-7/8 in. hole saw



Hole saw arbors

Part Number	Description
36-083	9/16 to 1-3/16 in. hole saw arbor
36-048	1-1/4 to 6 in. hole saw arbor



Hacksaw blades

Part Number	Description
36-006	32 teeth/in. hacksaw blade



Door wedge

Part Number	Description
MIS-DW-T2	Door wedge safety tool, for use on single-slide, center-opening, or two-speed hoistway door systems with sill grooves at least 7/16 in. wide





Hardware for Electrical Work

UL LISTED, CSA CERTIFIED AS NOTED

Nylon-insulated butt splices



Part Number	Size AWG	Color
21-001	22 - 18	Red
21-002	16 - 14	Blue
21-009	12 - 10	Yellow



ScotchLok® components



Part Number	Size AWG	Type
22-000	18 - 14	Style 560 - blue
22-001	22 - 16	Style 557 pigtail - red
22-020	22 - 16	Style 558 tap - red
22-021	12 - 10	Style 562 tap - yellow



Wire nuts



Part Number	Size AWG	Type
22-004	18 - 10	76B - red
22-005	18 - 12	74B - yellow
22-003	22 - 14	73B - orange
22-010	22 - 14	72B - blue
22-009	22 - 16	71B - gray



Lever nuts



Part Number	Size AWG	Type
222-413	28 - 14	3-pole Cage Clamp connection
222-415	28 - 14	5-pole Cage Clamp connection



Wire joints



Part Number	Description
22-031	Wire joint, min. 2 #24, max. 2 #16
22-032	Wire joint, min. 4 #18, max. 2 #12



Cable ties and mounting base



Part Number	Length Inches	Max. Width Inches
23-001	4.0	.095
23-004	6.1	.141
23-002	8.0	.185
23-012	11.1	.141
23-003	14.9	.275
23-013	30.7	.275
23-032*	Mounting Base	.19

*Mounting base is UR rated and not UL listed.



Wire marker cards and dispensers

Part Number	Description
25-001	Wire marker cards, nos. 1 - 33
25-003	Wire marker cards, nos. 34 - 66
25-005	Wire marker cards, nos. 67 - 99
25-006	Wire marker dispenser



Hardware for Electrical Work

UL LISTED, CSA CERTIFIED AS NOTED

Mechanical lugs



Part Number	Wire Size / Hole Size AWG
17-002	14-6 / #10
17-005	1/0-4/0 / 3/8 in.
17-001	8-2 / 1/4 in.
17-031	14-6 / 3/8 in.
17-032	4-2/0 / 3/8 in.



Ring terminals

Part Number	Wire Size / Type AWG
20-015	22-18 insulated - red #6 ring
20-026	22-18 non-insulated #8 ring
20-002	22-18 insulated - red #10 ring
20-001	18-14 non-insulated #10 ring
20-003	16-14 insulated - blue #10 ring
20-113	16-14 insulated - blue #8 ring



Compression lugs



Part Number	Wire Size / Hole Size AWG
17-019	1/0 / 3/8 in.
17-034	2/0 / 3/8 in.
17-035	3/0 / 3/8 in.
17-036	4/0 / 3/8 in.
17-015	1 / 3/8 in.
17-020	2 / 3/8 in.
17-021	4 / 3/8 in.
17-037	6 / 3/8 in.
17-022	8 / 3/8 in.
17-008	1 / 1/2 in.



Fork terminals

Part Number	Wire Size / Type AWG
20-012	22-18 non-insulated #6 fork
20-048	22-18 insulated - red #6 fork
20-019	22-18 insulated - red #8 fork
20-020	22-18 insulated - red #10 fork
20-016	16-14 insulated - blue #6 fork
20-017	16-14 insulated - blue #8 fork
20-018	16-14 insulated - blue #10 fork



Female disconnects



Part Number	Type and Size
20-004	#22-18 non-insulated .110 x .032 in.
20-047	#22-18 insulated .110 x .032 in.



Split bolt connectors

Part Number	Wire Size / Type AWG
17-041	1-3/0
17-046	2-6
17-073	4-8
17-086	10-12



Tape



Part Number	Description
All Tape 3/4" Wide	
16-006	#33 black electrical, 66 ft.
16-008	#35 white electrical, 66 ft.
16-009	#35 red electrical, 66 ft.
16-010	#35 blue electrical, 66 ft.
16-011	#35 green electrical, 66 ft.
16-012	#35 yellow electrical, 66 ft.
16-013	#35 orange electrical, 66 ft.
16-014	#35 brown electrical, 66 ft.
16-002	Friction, 60 ft.
16-003	Rubber, 22 ft.
16-005	#1700 electrical, 60 ft.



Lights and electrical

Part Number	Description
36-070	Rough service bulbs, 100 watt, package of 60
37-001	Porcelain fixture, with collar and pull chain
37-021	Plastic cage
36-033	Drop light with cage and hook, 25 ft. cord
36-034	Drop light with cage and hook, 50 ft. cord
37-178	GFCI with cover, 125VAC, 15A

Use these tools for crimping.

#017-5-0005 Draka QuickCrimp



#36-097 Crimping tool





Fasteners

Round-head nuts and screws

Part Number	Description
26-005	Round-head nuts and screws, 1/4 x 3/4 in.
26-001	Round-head nuts and screws, 1/4 x 1 in.
26-002	Round-head nuts and screws, 1/4 x 1-1/4 in.
26-003	Round-head nuts and screws, 1/4 x 1-1/2 in.
26-004	Round-head nuts and screws, 1/4 x 2 in.



Washers

Part Number	Description
54-001	Flat washers, 3/8 in.
54-003	Flat washers, 1/4 in.
59-004	Lock washers, 3/8 in.
54-002	Lock washers, 1/4 in.



Hex nuts

Part Number	Description
55-001	Hex nuts, 1/4 in.
55-002	Hex nuts, 3/8 in.



Nail-ins

Part Number	Description
24-001	Nail-ins, 1/4 x 1 in.
24-025	Nail-ins, 1/4 x 1-1/2 in.



Lead anchors

Part Number	Description
24-004	Lead anchors, 3/8 in.
24-002	Lead anchors, 1/4 in.



Toggle bolts

Part Number	Description
36-035	Toggle bolts, 1/4 x 3 in.



Hex-head bolts

Part Number	Description
36-036	Hex-head bolt, 1/4 x 1 in.



Threaded rod

Part Number	Description
44-017	Threaded rods, 3/8 in. x 6 ft.
09-051	Threaded couplings, 3/8 in.



Standard fasteners are grade 2, zinc-coated.

Strut

Strut

Part Number	Description
44-338	14-gauge strut, holes one side, 13/16 in. x 1-5/8 in. x 120 ft.
44-339	12-gauge strut, holes one side, 1-5/8 in. x 1-5/8 in. x 120 ft.
44-340	12-gauge strut, holes three sides, 1-5/8 in. x 1-5/8 in. x 120 ft.



Nuts

Part Number	Description
44-021	1/4 in. spring nut, for 1-5/8 in. strut
44-064	5/16 in. spring nut, for 1-5/8 in. strut
44-014	3/8 in. spring nut, for 1-5/8 in. strut
44-023	1/2 in. spring nut, for 1-5/8 in. strut
44-024	1/4 in. spring nut, for 13/16 in. strut
44-018	3/8 in. spring nut, for 13/16 in. strut
44-072	1/2 in. spring nut, for 13/16 in. strut
44-058	1/4 in. nut, for all strut
44-059	3/8 in. nut, for all strut
44-057	1/2 in. nut, for all strut



Connectors

Part Number	Description
44-341	Two-hole corner connector
44-342	Three-hole corner connector
44-343	Four-hole corner connector
44-347	Five-hole corner connector
44-344	Eight-hole two-way wing connector



Straps

Part Number	Description
44-002	1/2 in. EMT strap, for all strut
44-009	3/4 in. EMT strap, for all strut
44-003	1 in. EMT strap, for all strut
44-019	1-1/4 in. EMT strap, for all strut
44-012	1-1/2 in. EMT strap, for all strut
44-004	2 in. EMT strap, for all strut
44-030	2-1/2 in. EMT strap, for all strut





LED Lighting Systems

FOUR REASONS WHY i2SYSTEMS' LEDs ARE THE WAY TO LIGHT YOUR CAB

Efficiency – more light with less power

Since their inception, LEDs have always been remarkably efficient at around 8% of power converted to lumens. While other types of lamps use 13 to 40 watts per lamp to produce ANSI-mandated levels of illumination, an i2Systems LED uses as little as 4 watts to produce as many as 200 lumens. A standard installation of an Apeiron LTE+ fifth generation LED six-lamp package for a 2000 - 3500 lbs. capacity cab exceeds ANSI A17.1-2007 standards for illumination by a substantial amount.

Longevity – 4x to 20x more life than CFLs and halogen

Longevity is another i2Systems advantage. LEDs from i2Systems last four times longer than a fluorescent lamp and twenty times longer than a halogen lamp. Not only is that a substantial saving in material, it's a big savings in labor when replacing bulbs and ballasts. And as 'green' mandates become more and more prevalent, that also means fewer special disposal problems for 'dirty' burnt-out lamps.

Installed cost – they pay for themselves

i2Systems fifth generation LED cab lighting is not only within reach of any modernization budget, it is also the undisputed leader in installed and maintained cost. Based on energy savings alone, LEDs from i2Systems typically pay back the cost of installation in under one year (not including government rebates for energy efficient products).

Light color and quality –

warm and bright beats green and flickering

It has been shown that people are most comfortable with warm to neutral white light. Lamps from i2Systems are available in warm (3000°K) and bright white (4000°K) colors. And, unlike fluorescents, there is no annoying flicker.

Most important, LEDs from i2Systems are designed to look as good as they work. The Apeiron LTE+ puck-style lights come in gold, chrome, brushed nickel and black finishes, and in round and square styles. The Gen5 elevator linear LEDs easily replace up to 20 feet of fluorescent tubes with 12, 18, 24, 36 and 48 inch lengths that offer perfectly focused light that fit the ambiance of an elevator cab perfectly.

For cab modernization, the goal is improvement. Puck and linear LEDs from i2Systems are a major improvement over traditional and outdated technologies. Not only do they improve performance, they do it at a best installed and operational cost.



LED Lighting Systems

i2SYSTEMS APEIRON LTE+ RECESSED LIGHTING

Apeiron LTE+ round and square dimmable LED lamps



Part Number	Description	Finish	Size and Shape
A4390Z-14CBBR	Apeiron LTE+ warm white lamp	Chrome	3 in. x 3 in. square
A4390Z-11CBBR	Apeiron LTE+ warm white lamp	Chrome	3 in. diameter round
A4390Z-11BBD	Apeiron LTE+ neutral white lamp	Chrome	3 in. diameter round
A4390Z-21CBBR	Apeiron LTE+ warm white lamp	Gold	3 in. diameter round
A4390Z-41CBBR	Apeiron LTE+ warm white lamp	Brushed nickel	3 in. diameter round
A4390Z-41BBD	Apeiron LTE+ neutral white lamp	Brushed nickel	3 in. diameter round
A4390Z-61CBBR	Apeiron LTE+ warm white lamp	Black	3 in. diameter round
A4390Z-61BBD	Apeiron LTE+ neutral while lamp	Black	3 in. diameter round
PS24V45W-E12D	Power supply with dimming		
PS24V45W-E12E	Power supply with dimming and battery backup (two lamps for 4+ hours)		



NOTE: Each power box will power up to 9 lamps.

Parts listed here are in-stock and ready to ship. Additional models and options are available.

The Apeiron LTE+ is a premium **dimnable** and cost-effective LED lighting system that outlasts similar halogen lights by a factor of 20.

The LTE+ system is literally a snap to install. The handsome lightweight lights click into position with spring clips – no screws are needed. They simply plug into the compact power box (available with an optional 4+ hour battery backup) – no wire nuts or terminals.

And unlike LED replacement bulbs, the LTE+ is designed specifically for elevators. The beam is focused for best illumination of the cab and the Color Rendering Index (CRI) is rated at 90+ for a 'true to life' light.

The Apeiron LTE+ is available in either a 3" round or 3" square size. The metal bezel is available in either chrome, gold, brushed nickel or black finishes. Dimmable power units are available with or without battery backup.

Features

- 3" round and square designs
- Available in multiple light system kits
- Emergency light operation
- Industry's best color rendering (CRI 90+)
- Light beam engineered specifically for elevators
- Simple installation – light clips in, wiring is plug and play
- Lightweight power box with dimming and optional battery backup
- cULus, RoHS, IGCC, uses LM-80 tested LEDs, LM-79 tested
- Made in the USA

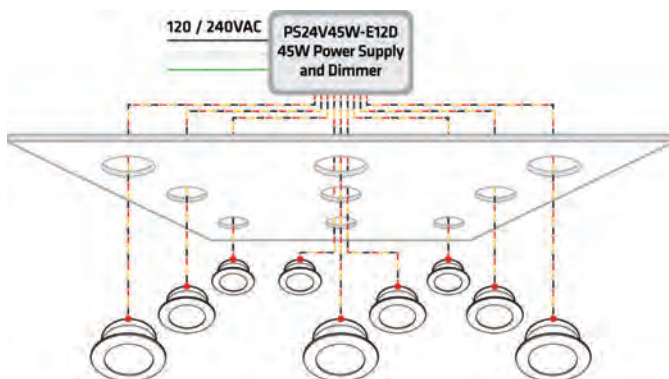

Number of Fixtures Required

Typical Capacity	Soft Light	Standard light	Bright light
2100 lbs	4	6	9
2500 lbs	4	6	9
3000 lbs	6	9	12
3500 lbs	6	9	12



LED Lighting Systems

i2SYSTEMS LINEAR LIGHTING SYSTEMS

S1205 linear dimmable LED lamps and power supplies



Part Number	Description	Length
S1205B-16CBB	S1205 warm white lamp	12 inches • 316 mm
S1205B-16BBD	S1205 neutral white lamp	12 inches • 316 mm
S1205B-86CBB	S1205 warm white lamp	18 inches • 468 mm
S1205B-86BBD	S1205 neutral white lamp	18 inches • 468 mm
S1205B-26CBB	S1205 warm white lamp	24 inches • 621 mm
S1205B-26BBD	S1205 neutral white lamp	24 inches • 621 mm
S1205B-36CBB	S1205 warm white lamp	36 inches • 621 mm
S1205B-36BBD	S1205 neutral white lamp	36 inches • 621 mm
S1205B-46CBB	S1205 warm white lamp	48 inches • 1230 mm
S1205B-46BBD	S1205 neutral white lamp	48 inches • 1230 mm
PS24V75W-E01D	Power box	
LL-101-01	LightLink dimmer	

NOTE: Each power box will power up to 20 feet of lamps - plan accordingly,



S1205B lamps are long strips of evenly lit LED covering 12 to 48 inch lengths with a very wide (65°) throw. This eliminates dark spots (socket shadow) between lamps. The Gen5 designation means that these lamps use power more efficiently.

The S1205B system has been engineered specifically for elevators in that a standard cab uses 20 feet of linear lamps – a single power supply comfortably delivers the necessary wattage. Where dimming is required, simply plug a LightLink dimmer into the power box.

Installation is simple – each lamp has a 6 foot cable that easily plugs into the power box. Adjustable brackets allow the linear lamps to be mounted either flat or pivoted on a drop ceiling.

Features

- Available in 12, 18, 24, 36 and 48 inch lengths
- Industry's best color rendering (CRI 90+)
- Light beam engineered specifically for elevators
- Simple installation – custom mounting brackets, wiring is plug and play
- Lightweight power box with dimming and optional battery backup
- cULus, RoHS, IGCC, uses LM-80 tested LEDs, LM-79 tested
- Made in the USA

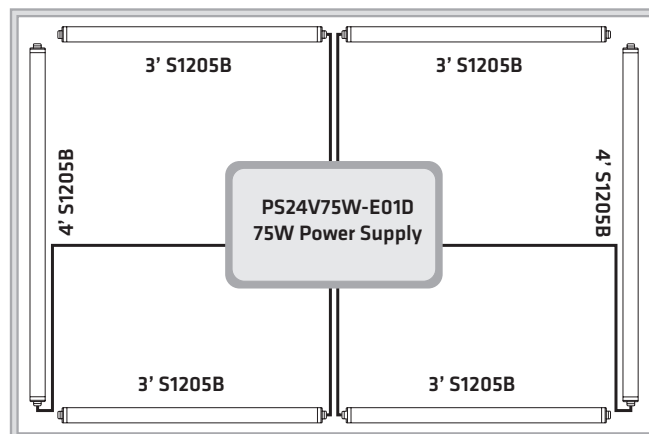

Mounting Brackets for Linear LEDs

Order two for each lamp

Part Number	Description
SLA-1	Adjustable mounting bracket
SLA-2	Fixed mounting bracket
SLA-3	End mount pivot

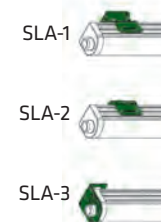

LED Lighting Systems

i2SYSTEMS ESCALATOR DEMARCATION LAMPS

S1203 Escalator Demarcation LEDs



Part Number	Description
S1203A-86D	Escalator demarcation lamp for damp conditions, 18", 9W, vibrant green light
PS24V60W-01	Power supply for up to two S1203 lamps
SLA-1	Adjustable mounting bracket for S1203, stainless steel, for damp areas
SLA-2	Fixed mounting bracket for S1203, stainless steel, for damp areas
SLA-3	End-mount pivot mounting bracket for S1203, stainless steel, for damp areas

Escalator demarcation LEDs are designed for damp and wet conditions. They offer the same operating advantages (longevity, low operating cost, light quality) as the other i2Systems LED lamps.

S1203 escalator demarcation lamps are part of our super-efficient Gen5 family of lamps. These 9 watt lamps offer rugged military-spec aluminum and polycarbonate construction. The lamps connect to the power supply with the attached 6 foot cables. Use one power supply and two lamps for each landing. Note that escalator demarcation lamps are not dimmable.

Use the SLA-1 or SLA-2 mounting brackets for fast installations. Order two brackets per lamp.



SL1 and VL3 Escalator Demarcation LEDs

Part Number	Description
SL1-865-3	Escalator demarcation lamp for dry/damp conditions, 18", 7.5W, white light
VL3-865-3-HB	Escalator demarcation lamp for wet conditions, 18", 12W, white light
PS24V35W-01	120/240V AC power supply for escalator LEDs
SLA-1	Adjustable mounting bracket for SL1-865-3, stainless steel, for damp areas
SLA-2	Fixed mounting bracket for SL1-865-3, stainless steel, for damp areas
SLA-3	End-mount pivot mounting bracket for SL1-865-3, stainless steel, for damp areas
VLA-5	Adjustable mounting bracket for VL3-865-3-HB, stainless steel, for wet areas
VLA-3	Fixed mounting bracket for VL3-865-3-HB, stainless steel, for wet areas
VLA-6	End-mount mounting bracket for VL3-865-3-HB, stainless steel, for wet areas

SL1 escalator demarcation LEDs are for damp conditions. VL1 escalator demarcation LEDs are for wet conditions.

Note that the mounting brackets are specified for either damp or wet environments. Order two brackets per lamp.

NOTE: Due to constant power design, input current will vary depending on input voltage. Be sure to use the correct AWG wire size for worst case input voltage.





Inspection Stations and Stop Switches

Top Of Car Inspection (TOCI) stations

Part Number	Description
TOCI-L	Top of car inspection box, with GFCI receptacle and light fixture/cage
TOCI-LF	Top of car inspection box, with GFCI receptacle, light fixture/cage and fire service light/buzzer indicators
TOCI-LA	Top of car inspection box, with GFCI receptacle, light fixture/cage and audible 6 - 28VDC alarm
TOCI-LFA	Top of car inspection box, with GFCI receptacle, light fixture/cage, fire service light/buzzer indicators and audible 6 - 28VDC alarm
CNTBLK-NO	Additional NO contact block
CNTBLK-NC	Additional NC contact block

TOCI stations house large, easy-to-read UP, DOWN, COMMON and STOP controls as well as a normal/inspection switch, 125VAC/25A GFCI receptacle and light fixture/cage in a bright yellow metal enclosure. They are available in four versions – with lamp fixture, lamp/fire service, lamp/alarm and lamp/fire service/alarm. NOTE: All stations come unwired; some field assembly required. Light bulb not included.



Stop switches

Part Number	Description
EN418-A	Locking stop switch

EN418-A stop switches use a push-pull action for sure, safe operation. A four-prong guard helps prevent accidental engagement of the switch. Large diagrams printed on the switch show clearly which are the RUN and STOP positions, while indicator windows show 'green for go' when the switch is in the ON position and 'red for stop' when in the STOP position. The EN418-A has one NO and one NC contact.



Part Number	Description
SLA11NPNC002	Locking stop switch

SLA11NPNC002 stop switches are the same as the EN418-A except they have a single NC contact and zero NO contact.



Pendant Stations

FIVE-BUTTON PENDANT STATIONS (UP, DOWN, COMMON, LOCKING STOP AND TUBULAR KEY SWITCH)

Standard pendant stations

Part Number	Description	Cable Length ft • m	Termination(s)
PEND-5B-T	Pendant station	unwired	none
PEND-5W-T	Pendant station, with pigtail	15 • 4.6	loose wires
PEND-5W-TC	Pendant station, with pigtail	15 • 4.6	male
PEND-5W-TV	Pendant station, with pigtail	made to order	loose wires
PEND-15-1	Cable extension	15 • 4.6	female/loose wires
PEND-50-1	Cable extension	50 • 15.2	female/loose wires
PEND-15-2	Cable extension	15 • 4.6	female/male
PEND-50-2	Cable extension	50 • 15.2	female/male
18/6 SEOW	Cut-to-length cable	specify	none

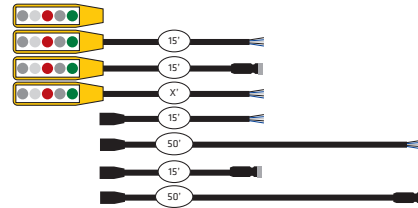

Pendant stations with 125V/20A GFCI

Part Number	Description	Cable Length ft • m	Termination(s)
PEND-5W-TG	Pendant station, with pigtail and GFCI	15 • 4.6	loose wires
PEND-5W-TGC	Pendant station, with pigtail and GFCI	15 • 4.6	male
PEND-5W-TGV	Pendant station, with pigtail and GFCI	made to order	loose wires
PEND-8GC-1	Cable extension for PEND-5WG-TC with GFCI	8 • 2.45	female/loose wires
PEND-15G-1	Cable extension, for GFCI versions	15 • 4.6	female/loose wires
PEND-50G-1	Cable extension, for GFCI versions	50 • 15.2	female/loose wires
PEND-15G-2	Cable extension, for GFCI versions	15 • 4.6	female/male
PEND-50G-2	Cable extension, for GFCI versions	50 • 15.2	female/male
14/3-18/5 SEOW	Cut-to-length cable, for GFCI versions	specify	none

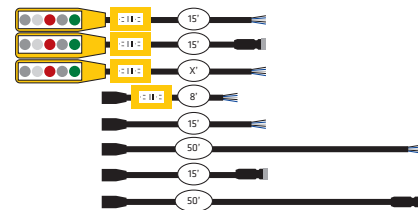

PEND-5 series pendant stations are made of high-impact plastic for durability and electrical safety. Keyed lockout and two-handed operation further increase their safe usage. Options include a 15 ft. • 4.6 meter pigtail; GFCI (Ground Fault Circuit Interrupter 120VAC) on the pigtail; connectorized pigtails; and cable extensions of either 15 ft. or 50 ft. • 4.6 m or 15.2 m.



Replacement parts

Part Number	Description
PEND-8REC	8-conductor replacement receptacle kit, with female connector
PEND-8PLUG	8-conductor replacement receptacle kit, with male connector
PEND-6REC	6-conductor replacement receptacle kit, with female connector
PEND-6PLUG	6-conductor replacement receptacle kit, with male connector
PEND-TUBEKEY	Key switch tubular replacement, with mounting hardware
PEND-UP	Up button replacement, with 1 NO + 1 NC contact blocks and mounting hardware
PEND-DOWN	Down button replacement, with 1 NO + 1 NC contact blocks and mounting hardware
PEND-ENABLE	Common button replacement, with 1 NO contact block and mounting hardware
PEND-STOP	Emergency stop button replacement, with 1 NC contact block and mounting hardware



Top of Car Safety Rails

TOC KITS / CONFORMS TO ASME 17.1 SPECIFICATIONS

BIG-TOC and LIL-TOC Top Of Car safety rails

Part Number	Toe-board Part Number	Description	Opening	Size Range (min > max) Width (in • m)	Depth (in • m)	Weight lbs • kg
100-01	100-01TB	LIL-TOC	front	57 > 82 • 1.45 > 2.08	57 > 82 • 1.45 > 2.08	148 • 67.2
100-01 / 100-20		LIL-TOC w/ two-sided extension kit	front	57 > 82 • 1.45 > 2.08	99 > 123 • 2.51 > 3.12	183 • 83.2
100-01 / 100-19		LIL-TOC w/ three-sided extension kit	front	99 > 123 • 2.51 > 3.12	99 > 123 • 2.51 > 3.12	200 • 90.9
100-03	100-03TB	BIG-TOC 60	front	69 > 118 • 1.75 > 3.00	69 > 118 • 1.75 > 3.00	184 • 83.6
100-03 / 100-20		BIG-TOC 60 w/ two-sided extension kit	front	69 > 118 • 1.75 > 3.00	123 > 159 • 3.12 > 4.0	219 • 99.5
100-03 / 100-19		BIG-TOC 60 w/ three-sided extension kit	front	123 > 159 • 3.12 > 4.04	123 > 159 • 3.12 > 4.04	236 • 107.3
100-05	100-05TB	BIG-TOC 72	front	69 > 118 • 1.75 > 3.00	81 > 130 • 2.06 > 3.30	192 • 87.3
100-05 / 100-20		BIG-TOC 72 w/ two-sided extension kit	front	69 > 118 • 1.75 > 3.00	135 > 171 • 3.43 > 4.34	227 • 103.2
100-05 / 100-19		BIG-TOC 72 w/ three-sided extension kit	front	123 > 159 • 3.12 > 4.04	135 > 171 • 3.43 > 4.34	244 • 110.9
100-13	100-13TB	LIL-TOC	front	45 > 70 • 1.14 > 1.78	69 > 106 • 1.75 > 2.69	158 • 71.8
100-15	100-15TB	LIL-TOC	front	57 > 82 • 1.45 > 2.08	69 > 106 • 1.75 > 2.69	162 • 73.6
100-17	100-17TB	LIL-TOC	front	57 > 82 • 1.45 > 2.08	45 > 70 • 1.14 > 1.78	141 • 64.1
100-13 / 100-20		LIL-TOC w/ two-sided extension kit	front	45 > 70 • 1.14 > 1.78	123 > 147 • 3.12 > 3.73	193 • 87.7
100-15 / 100-20		LIL-TOC w/ two-sided extension kit	front	57 > 82 • 1.45 > 2.08	123 > 147 • 3.12 > 3.73	197 • 89.5
100-17 / 100-20		LIL-TOC w/ two-sided extension kit	front	57 > 82 • 1.45 > 2.08	99 > 111 • 2.51 > 2.89	176 • 80.0
100-13 / 100-19		LIL-TOC w/ three-sided extension kit	front	99 > 111 • 2.51 > 2.89	123 > 147 • 3.12 > 3.73	210 • 95.5
100-15 / 100-19		LIL-TOC w/ three-sided extension kit	front	99 > 123 • 2.51 > 3.12	123 > 147 • 3.12 > 3.73	214 • 97.3
100-17 / 100-19		LIL-TOC w/ three-sided extension kit	front	99 > 123 • 2.51 > 3.12	99 > 111 • 2.51 > 2.89	193 • 87.7
100-07	100-07TB	LIL-TOC F&R	front and rear	n/a	57 > 82 • 1.45 > 2.08	116 • 52.7
100-09	100-09TB	BIG-TOC 60 F&R	front and rear	n/a	69 > 118 • 1.75 > 3.00	142 • 64.5
100-11	100-11TB	BIG-TOC 72 F&R	front and rear	n/a	81 > 130 • 2.06 > 3.30	149 • 67.7
100-07 / 100-20		LIL-TOC F&R w/ two-sided extension kit	front and rear	n/a	99 > 123 • 2.51 > 3.12	151 • 68.6
100-09 / 100-20		BIG-TOC 60 F&R w/ two-sided extension kit	front and rear	n/a	123 > 159 • 3.12 > 4.04	177 • 80.5
100-11 / 100-20		BIG-TOC 72 F&R w/ two-sided extension kit	front and rear	n/a	135 > 171 • 3.43 > 4.34	184 • 83.6

BIG-TOC and LIL-TOC (Top Of Car) safety rail kits install on top of freight and passenger traction elevators to create a safer and more secure car-top environment for both people and their tools. These permanent guardrail kits are easy to install and quickly adjust to the required size.

They are adaptable to both front-opening and front-and-rear opening car types. All rails, bolts, nuts and hardware are included. The major siderail components come pre-assembled. Installation generally takes under an hour. The toe board is ordered separately and serves as an added measure to prevent the loss of tools and other important items.

Determining width and depth requirements for your TOC safety rail kit:

Width – The distance between the roller guide plates determines width, because the TOC side rails mount inside the roller guide plates.

Depth – Measure the inside car depth.

Height – Height is adjustable and is measured from the top of the car to the top handrail of the installed TOC safety rail kit.

NOTE: If clearance between the top of the car and the bottom of the crosshead is less than 18", please call for assistance.

All listed toe boards are 4" height; 5" height available upon request.

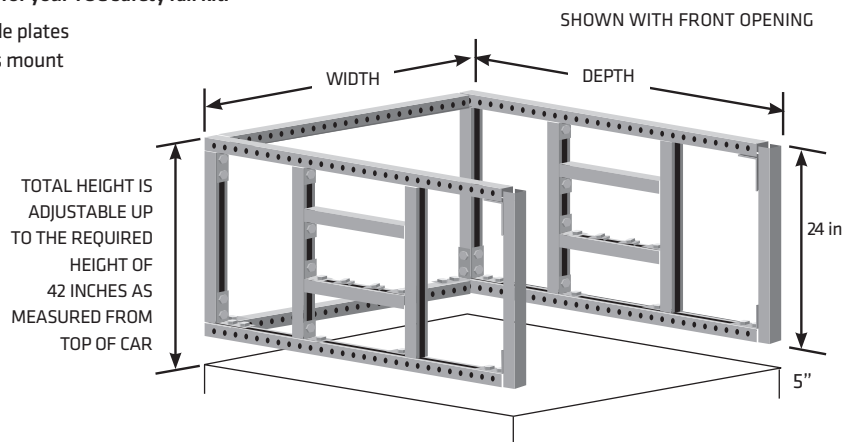

Hoistway Safety

HOSS™ SYSTEMS

BIG-HOSS™ Hoistway Obstruction Shield System

Part Number	Description
BIG-HOSS	Hardware Cloth Base Mounting Kit, 100 feet • 30.48 m length
BIG-HOSS-75	Hardware Cloth Base Mounting Kit, 75 feet • 22.86 m length
BIG-HOSS-150	Hardware Cloth Base Mounting Kit, 150 feet • 45.72 m length

The Hoistway Obstruction Shield Systems are used to prevent round and flat elevator traveling cable from repetitively striking obstructions in the hoistway and from crossing over into adjoining hoistways. Their use may help avoid possible interference and extend the life span of the installed elevator cables.

The BIG HOSS kit includes 100 ft • 30.48 m of the 1.5 ft • 0.46 m wide shielding material (1/2 in. • 13 mm mesh hardware cloth) and all the mounting hardware needed to attach the shield within the hoistway. All components are shipped in a single bag.

LIL-HOSS™ shield system extensions

Part Number	Description
LIL-HOSS	Hardware Cloth Extension Mounting Kit, 100 feet • 30.48 m length
LIL-HOSS-75	Hardware Cloth Extension Mounting Kit, 75 feet • 22.86 m length
LIL-HOSS-150	Hardware Cloth Extension Mounting Kit, 150 feet • 45.72 m length

The LIL-HOSS kit includes an additional 100 ft • 30.48 m of the shielding material and all the mounting hardware needed to attach the shield to the top of the BIG HOSS system and walls of the hoistway. Like the BIG HOSS, all LIL HOSS components are shipped in a single bag.

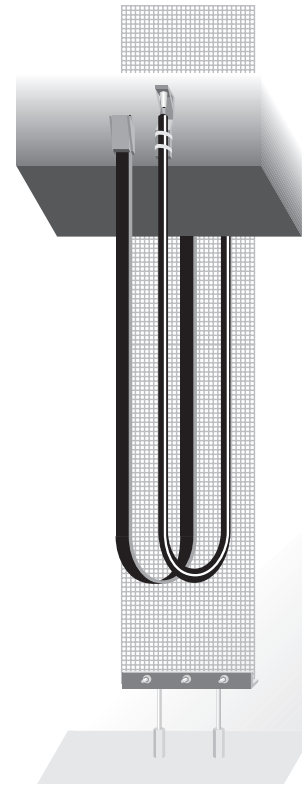



EZ Grip – US Patent 8,403,283 B2

Part Number	Description
EZ GRIP	One EZ Grip barricade clamp
EZ GRIP KIT	One pair (two) of EZ Grip barricade clamps

The EZ Grip quickly and easily attaches barricades directly to escalator balustrades (as mandated by recent safety policies).



'Do Not Use' signs

Part Number	Description
022-6-0001	Do Not Use signs, 4 x 6 in., self-adhesive, 50 per pack



Certificate Frame

Part Number	Description
MIS-CF-100	Certificate frame, stainless steel, 7" x 10"



Pit Safety Kits, Car Escape Hatch Switches and Exhaust Fans

Pit ladder

Part Number	Description
SEES-PIT-LDR-001	Pit ladder, 9 ft. tall with 16 in. anti-skid round rungs (measured inside uprights)
SEES-PIT-LDR-001E	Pit ladder extension, 2 ft. tall with 16 in. anti-skid round rungs
SEES-PIT-LDR-002E	Pit ladder, 9 ft. tall with 12 in. anti-skid round rungs (measured inside uprights)
PIT-LDR-12RR2X	Pit ladder extension, 2 ft. tall with 12 in. anti-skid round rungs

All pit ladders include reversible ladder mounting brackets that permit the ladder to be mounted either 4-1/2 in. or 7 in. from the wall.



Pit light

Part Number	Description
SEES-PIT-LT-001	Pit light, with metal cage, safety guard, GFCI outlet and switch, 120VAC, 15A

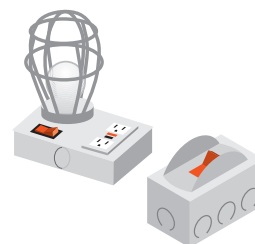

Pit stop switch

Part Number	Description
PIT-SWITCH	Pit toggle stop switch, lockable, 120/277VAC, 20A



Governors

CERTIFIED BY TÜV TO EN81 AND 95/16/EC

LK315 – bidirectional with 315 mm diameter sheave



Part Number	Rope Diameter mm	Nominal Speed m/sec	Trip Speed m/sec	Weight kg
LK315 RL 0,42	8.0 - 10.0	2.81	0.42	14
LK315 RL 0,56	8.0 - 10.0	2.81	0.56	14
LK315 RL 0,70	8.0 - 10.0	2.81	0.70	14
LK315 RL 0,84	8.0 - 10.0	2.81	0.84	14
LK315 RL 0,92	8.0 - 10.0	2.81	0.92	14
LK315 RL 1,00	8.0 - 10.0	2.81	1.00	14
LK315 RL 1,13	8.0 - 10.0	2.81	1.13	14
LK315 RL 1,26	8.0 - 10.0	2.81	1.26	14
LK315 RL 1,40	8.0 - 10.0	2.81	1.40	14
LK315 RL 1,60	8.0 - 10.0	2.81	1.60	14
LK315 RL 2,00	8.0 - 10.0	2.81	2.00	14
LK315 RL 2,25	8.0 - 10.0	2.81	2.25	14
LK315 RL 2,40	8.0 - 10.0	2.81	2.40	14
LK315 RL 2,73	8.0 - 10.0	2.81	2.73	14
LK315 RL 3,24	8.0 - 10.0	2.81	3.24	14



Please specify the following options:

- Remote control with automatic reset - 12VAC or DC, 24VAC or DC, 48VAC or DC, 110VAC or DC, 230VAC or DC voltages
- Mounting base size/distance between holes - 154 mm, 172 mm, 180 mm
- Test groove
- Encoder

Other bi-directional and uni-directional governors are available – please call for details.

Hoistway/Hatch Switches

LISTINGS AND CERTIFICATIONS AS NOTED

ZS231-11YR(A) limit switch



Part Number	Description
020-4-0039	ZS231-11YR(A) limit switch, ≤ 15 N activation, 1 NO / 1 NC, manual reset, rated for IP65, movement ≥ 6.5 mm, electric clearance ≥ 6.0 mm, rated for use at 230VAC@4A, 400VAC@2.5A, 500VAC@1A



NZ-T1R236-02Z limit switch



Part Number	Description
020-4-0043	NZ-T1R236-02Z limit switch, ≤ 15 N activation, 2 NC, automatic reset, rated for IP65, movement ≥ 6.5 mm, electric clearance ≥ 6.0 mm, rated for use at 230VAC@4A, 400VAC@2.5A, 500VAC@1A



NZ-ZS231-11YR(B) limit switch



Part Number	Description
020-4-0040	NZ-ZS231-11YR(B) limit switch, ≤ 15 N activation, 1 NO / 1 NC, manual reset, rated for IP65, movement ≥ 6.5 mm, electric clearance ≥ 6.0 mm, rated for use at 230VAC@4A, 400VAC@2.5A, 500VAC@1A



NZ-Z1R236-11Z limit switch



Part Number	Description
020-4-0044	NZ-Z1R236-11Z limit switch, ≤ 15 N activation, 1 NO / 1 NC, manual reset, rated for IP65, movement ≥ 6.5 mm, electric clearance ≥ 6.0 mm, rated for use at 230VAC@4A, 400VAC@2.5A, 500VAC@1A



NZ-TV231-11YU limit switch



Part Number	Description
020-4-0041	NZ-TV231-11YU limit switch, ≤ 15 N activation, 1 NO / 1 NC, automatic reset, rated for IP65, movement ≥ 6.5 mm, electric clearance ≥ 6.0 mm, torque ≤ 0.15 N, rated for use at 230VAC@4A, 400VAC@2.5A, 500VAC@1A



Cable Gland

Part Number	Description
020-4-0052	Cable gland, to fit bottom of switches, M20 thread, cable OD range 0.19 - 0.39 in.



Adapter

Part Number	Description
020-4-0053	Adapter, plastic, to fit bottom of switches, converts M20 female to 1/2 in. NPT female



NZ-T1R236-11Z limit switch



Part Number	Description
020-4-0042	NZ-T1R236-11Z limit switch, ≤ 15 N activation, 1 NO / 1 NC, automatic reset, rated for IP65, movement ≥ 6.5 mm, electric clearance ≥ 6.0 mm, rated for use at 230VAC@4A, 400VAC@2.5A, 500VAC@1A



Lock Nut

Part Number	Description
020-4-0161	Lock nut, plastic, for use with cable gland 020-4-0052 when mounting to box



Cable glands and adapters sold separately. These switches have M20-threaded entries.



Hoistway/Hatch Switches

LISTINGS AND CERTIFICATIONS AS NOTED

NZ-Z1R236-02Z

limit switch



Part Number	Description
020-4-0045	NZ-Z1R236-02Z limit switch, ≤ 15 N activation, 2 NC, manual reset, rated for IP65, movement ≥ 6.5 mm, electric clearance ≥ 6.0 mm, rated for use at 230VAC@4A, 400VAC@2.5A, 500VAC@1A



NZ-TV7H236-11Z

limit switch



Part Number	Description
020-4-0048	NZ-TV7H236-11Z limit switch, ≤ 15 N activation, 1 NO / 1 NC, automatic reset, rated for IP65, movement ≥ 6.5 mm, electric clearance ≥ 6.0 mm, torque ≤ 0.15 N, rated for use at 230VAC@4A, 400VAC@2.5A, 500VAC@1A



NZ-TS236-11Z

limit switch



Part Number	Description
020-4-0046	NZ-TS236-11Z limit switch, ≤ 15 N activation, 1 NO / 1 NC, automatic reset, rated for IP65, movement ≥ 6.5 mm, electric clearance ≥ 6.0 mm, torque ≤ 0.15 N, rated for use at 230VAC@4A, 400VAC@2.5A, 500VAC@1A



NZ-TV7H236-11Z

limit switch



Part Number	Description
020-4-0160	NZ-TV7H236-11Z limit switch, ≤ 15 N activation, 1 NO / 1 NC, automatic reset, rated for IP65, movement ≥ 6.5 mm, electric clearance ≥ 6.0 mm, torque ≤ 0.15 N, rated for use at 230VAC@4A, 400VAC@2.5A, 500VAC@1A



NZ-TS236-11Z

limit switch



Part Number	Description
020-4-0047	NZ-TV10H236-11Z limit switch, ≤ 15 N activation, 1 NO / 1 NC, automatic reset, rated for IP65, movement ≥ 6.5 mm, electric clearance ≥ 6.0 mm, torque ≤ 0.15 N, rated for use at 230VAC@4A, 400VAC@2.5A, 500VAC@1A



Mounting brackets for limit switches

Part Number	Description
LS-BRKT-G	Mounting bracket, for 020-4-0160 limit switches
LS-BRKT-KIT-G	Mounting bracket kit, includes mounting bracket, hardware and one 020-4-0160 limit switch
LS-STRUTBRKT-17	17 in. adjustable strut-style bracket, assembled, with mounting hardware and one 020-4-0160 limit switch

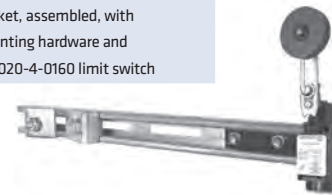

FT140X11

limit switch



Part Number	Description
FT140X11	FT140X11 limit switch, ≤ 10 N activation, 1 NO / 1 NC, automatic reset, rated for IP65, rated for use at 400VAC@1.9A, 24VDC@2.8A



Hoistway/Hatch Switches

UL LISTED, CSA CERTIFIED

EECO MIS-181B limit switch

Part Number	Description
MIS-181B	Limit switch, for setting zoning, normal and final limits, 1 NO and 1 NC contacts, rated for 300VAC@8A or 230VDC@1A



EECO MIS-181 magnet switch

Part Number	Description
MIS-181	Magnetic leveling switch, for zone switches and leveling control units, dead zone, < 1/8 in. @ 1/4 in. gap, 1 NO and 1 NC contacts, rated for 300VAC@8A or 230VDC@1A



EECO LS-1W limit switch

Part Number	Description
LS-1W	Limit switch, like LS-1B above but with weatherproof design

EECO MV-4W magnet switch

Part Number	Description
MV-4W	Permanent magnet switch, like MV-4C above but with weatherproof design

EECO LS-1D limit switch

Part Number	Description
LS-1D	Limit switch, for setting zoning, normal and final limits, 2 NO and 2 NC contacts, rated for 300VAC@8A or 230VDC@1A



EECO MIS-181C magnet switch

Part Number	Description
MIS-181C	Magnetic leveling switch, for zone switches and leveling control units, dead zone < 1/8 in. @ 1/4 in. gap, 2 NO and 2 NC contacts, rated for 300VAC@8A or 230VDC@1A



Mounting bracket for EECO switches

Part Number	Description
LS-1B-BRKT	Mounting bracket, for all EECO limit/magnetic switches

EECO MV-4DW magnet switch

Part Number	Description
MV-4DW	Permanent magnet switch, like MV-4D above but with weatherproof design

Magnet inductor switch

Part Number	Description
LDS3004A	Permanent magnet inductor switch, for slowdown and landing positions, recommended for retrofit of EECO vane-operated landing systems, 1 NO and 1 NC contacts, rated for 250VDC@0.5A





Fiber Optic Transmission Kits for UTP connections

UL LISTED, CSA CERTIFIED

The amount and content of elevator communications (high-resolution video surveillance, telephony, control signals, audio, etc.) is ever increasing. Fiber optic cable is an ideal answer for these needs.

Fiber optic transmission kits convert electronic signals from cameras and the like into optical signals and back to electronic signals at the other end. Draka offers two solutions for electro-optical signal tx/rx:

Signamax full duplex (two way) Ethernet 10/100BaseT to fiber transmission

Part Number	Description
F10651100KIT62ST	Two box-style units with RJ-45 electronic and ST optical input/output for Ethernet to 62.5µm 100BaseFX conversion - includes two Cat6 five foot jumpers and two three meter ST patchcords
F10651100KIT62SC	As above but with 62.5µm SC input/output and two three meter SC patchcords
F10651100KIT50ST	Two box-style units with RJ-45 electronic and ST optical input/output for Ethernet to 50µm 100BaseFX conversion - includes two Cat6 five foot jumpers and two three meter ST patchcords
F10651100KIT50SC	As above but with 50µm SC input/output and two three meter SC patchcords



Signamax tx/rx units accept 10/100BaseT electronic signals through RJ-45 jacks and convert them for duplex (two-way) optical transmission over either 62.5µm or 50µm multimode fiber and ST and SC connectors. The system consists of two units, power supplies and patchcords. Call for other configuration options.

American Fibertek M100C simplex (one way) video

Part Number	Description
F1-MTRM100KIT62	Tx/Rx pair of modules for coax to 62.5µm fiber conversion - includes power supplies and two 62.5µm ST patchcords
F1-MTRM100KIT50	As above but with 50µm input/output and two 50µm ST patchcords



American Fibertek M100C units are compact video converters that transmit one-way from cab to security center. They can operate over either 62.5µm or 50µm multimode fiber with any camera with a coaxial output. ST and SC versions are available. The system consists of a tx/rx pair with power units and patchcords.

CONTROLLERS / MACHINE ROOM

QUICK LOCATOR GUIDE

Cables and Splitters	221
Drive Units	221
Fans	221
Flavasco Elevator Machine Guarding	224-227
Pipe	222-223
Reynolds Door Speed Controllers	221
SEES Selector Assembly	220
Selector Parts	220
SmartRise Controllers	218-219
Battery Lowering Unit	218
Cables	218
CE Drive Printed Circuit Board	218
Car Operating Panel	218
Hall Operating Panel	218
Inspection Station	218
Interface Printed Circuit Board	219
Relays	219
Valve Interface Board	219
Sprecher + Schuh Soft Starters	219



SmartRise

S.E.E.S. #	O.E.M. #	Description
SEES-SMARTRISE-001	SRH-MPAK	Controller , Machine Room Panel, minus soft starter
SEES-SMARTRISE-001K		SmartRise Kit , Complete Kit for Specific Job
SEES-SMARTRISE-PKG-051		Controller , Package 51A Soft Start, 2 Board System
SEES-SMARTRISE-PKG-074		Controller , Package 74A Soft Start, 2 Board System
SEES-SMARTRISE-PKG-104		Controller , Package 104A Soft Start, 2 Board System
SEES-SMARTRISE-PKG-147		Controller , Package 147A Soft Start, 2 Board System
SEES-SMARTRISE-COP-002	SRH-CPAK	Car Operating Panel , for SmartRise 2 Board package
SEES-SMARTRISE-HOP-001	SR1000	Hall Operating Panel , Hall/Lantern Board for SmartRise package
SEES-SMARTRISE-BATL-001	RB2-240-PAK	Battery Lowering Unit , for SmartRise package
SEES-SMARTRISE-POW-001		Smartrise, power supply , 24V 100-264V Input, Din Rail Mount
SEES-SMARTRISE-CEDB-001	SEI001	CE Drive Board , for Digital PI with SmartRise package
SEES-SMARTRISE-CAT5PK-001	CAT-5 PACKAGE	Cable pack , Cat 5 Cables with Splitter
SEES-SMARTRISE-BOB-001	SR-2003	BreakOut Board , for CAT5 to Individual I/O's
SEES-SMARTRISE-COP-002R	SRU-8	Replacement Board , SRU-8 COP Board
SEES-SMARTRISE-DLB-001	SR-3070	Door Lock Board , SR-3070
SEES-SMARTRISE-DUPLEX-001	DUPLEX BOX	Group Controller , for Duplex Operation
SEES-SMARTRISE-INSP-001	INSPECTION BOX	Inspection Station , Pre-Wired Top of Car Box
SEES-SMARTRISE-PROG-001	PROG-POD	SRU Programming POD , for Installing Software



SEES-SMARTRISE-COP-002



SEES-SMARTRISE-HOP-001



SEES-SMARTRISE-BATL-001



SEES-SMARTRISE-POW-001

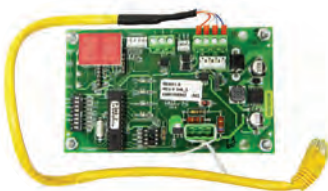

SEES-SMARTRISE-CEDB-001



SEES-SMARTRISE-CAT5PK-001

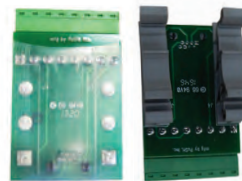

SEES-SMARTRISE-BOB-001

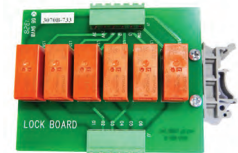

SEES-SMARTRISE DLB-001

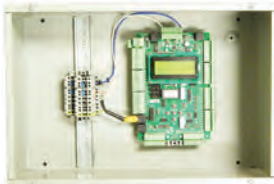

SEES-SMARTRISE-DUPLEX-001



SEES-SMARTRISE-INSP-001



SEES-SMARTRISE-PROG-001



SEES-SMARTRISE-TOOL

SmartRise

S.E.E.S. #	O.E.M. #	Description
SEES-SMARTRISE-TOOL		Smartrise Debug Tool
SEES-SMARTRISE-SLR-001	120 VAC SLIMLINE RELAY	Relay , Slimline Relay 120 VAC
SEES-SMARTRISE-SLR-001A	29 66 032	Contact Terminal Block
SEES-SMARTRISE-SLR-002	24VDC SLIMLINE RELAY	Relay , Slimline Relay 24 VDC
SEES-SMARTRISE-SR-001	SAFETY-RELAY	Relay , Safety Relay
SEES-SMARTRISE-VIB-001	SR-3050	Valve Interface Board , SR-3050
SMR-001		Relay , 24 VDC 6A SPDT, Used On SmartRise Controller
GPC-008	D3000-PAK	Interface PCB , for MOD



SEES-SMARTRISE-SLR-001



SEES-SMARTRISE-SLR-001A



SEES-SMARTRISE-SLR-002



SEES-SMARTRISE-SR-001

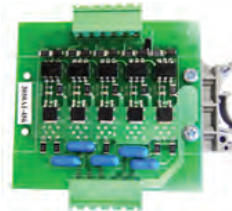

SEES-SMARTRISE-VIB-001

Other Controllers

S.E.E.S. #	Description
HYD-CONTROLLER-001R	Controller , VHC-102 with Reflex Selector, VMI
HYD-CONTROLLER-002	Controller , Basic Hydro Controller less Soft Start
HYD-CONTROLLER-002M	Magnets , For -002 Controller, ATEL

Sprecher+Schuh Soft Starters

S.E.E.S. #	Description
PCEC-032-600V-120V	S&S Soft Starter 32A 600V 120 VAC Y/D
PCEC-032-600V-230V	S&S Soft Starter 32A 600V 230 VAC Y/D
PCEC-051-600V-120V	S&S Soft Starter 51A 600V 120 VAC Y/D
PCEC-051-600V-230V	S&S Soft Starter 51A 600V 230 VAC Y/D
PCEC-064-600V-120V	S&S Soft Starter 64A 600V 120 VAC Y/D
PCEC-064-600V-230V	S&S Soft Starter 64A 600V 230 VAC Y/D
PCEC-074-600V-120V	S&S Soft Starter 74A 600V 120 VAC Y/D
PCEC-074-600V-230V	S&S Soft Starter 74A 600V 230 VAC Y/D
PCEC-104-600V-120V	S&S Soft Starter 104A 600V 120 VAC Y/D
PCEC-104-600V-230V	S&S Soft Starter 104A 600V 230 VAC Y/D
PCEC-147-600V-120V	S&S Soft Starter 147A 600V 120 VAC Y/D
PCEC-147-600V-230V	S&S Soft Starter 147A 600V 230 VAC Y/D
PCEC-234-600V-120V	S&S Soft Starter 234A 600V 120 VAC Y/D
PCEC-234-600V-230V	S&S Soft Starter 234A 600V 230 VAC Y/D



PCEC-051-600V-120V



PCEC-051-600V-230V



SEES Selector

S.E.E.S. #	O.E.M. #	Description
HYD-CONTROLLER-002-SELECTOR		
		Selector Assembly , For -002 Controller, Tapeless
SEES-SELECTOR-001	IP READER	Selector , Assembly
SEES-SELECTOR-003	IP MOUNTING KIT	Selector , Mounting Kit
SEES-SELECTOR-DZMK-001		Tape and Door Zone Mounting Kit , 1 Per Floor
SEES-SELECTOR-MAG-001	IP8300-LSM-DZ	Selector , Door Zone Magnet 1 Per Floor
SEES-SELECTOR-MAG-001K	IP8300-LSM-KIT	Selector , Door Zone Magnet 1 Per Elevator
SEES-SELECTOR-TAPE-002		Selector Tape , for APS Systems, 38M IR Tape
SEES-SELECTOR-TAPE-003		Selector Tape , for APS Systems, 67M IR Tape
SEES-SELECTOR-TAPE-004		Selector Tape , for APS Systems, 17M IR Tape
SEES-SELECTOR-TG-001		SEES Selector Tape Guide , 3 hole with thumbscrew
WS-5A		Tape Guide , nylon with holes IP8300
WS-5AB		Tape Guide , heavy duty brass, for IP8300
WS-5A-INSERT		Insert for Tape Guide
DS-43	141618	Selector Tape , 3"
DS-43-SS		Selector Tape , Stainless Steel .032 x 3" W
ES-001	9745312	Vane Magnetic Selector Tape , ELGO Selectors, Absolute Positioning for Dover/Thyssen
HL-101A	LECSELECTORKIT	Selector Kit , EMI Home Lift
ECT-PCB-001	890-0030-0010	Selector Board , 10p/NO Sensors
ECT-PCB-002	890-0030-007A	Freight Main Board , VHC-102

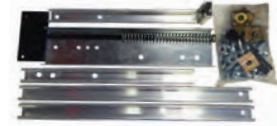

SEES-SELECTOR-003

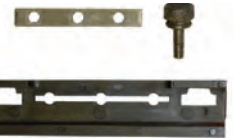

SEES-SELECTOR-TG-001



DS-43

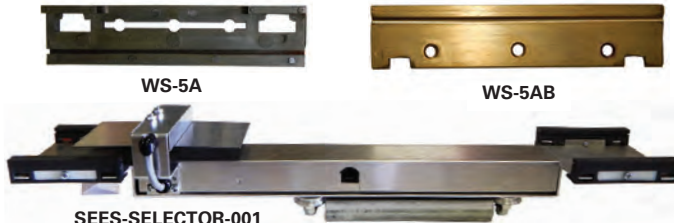

WS-5A

WS-5AB

SEES-SELECTOR-001

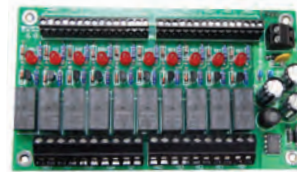

ECT-PCB-001



ECT-PCB-002

Selector Parts

S.E.E.S. #	O.E.M. #	Description
MIS-234	3-034-034	Esco Selector Cam , 1 lobe for 7A selector
MIS-235	3-034-035	Esco Selector Cam , 6 lobe for A7 selector
MIS-236	3-614-001	Selector Blade Spring , ESCO A-Selector 3-614-001
MIS-189S-A		Key only SEES #10 , for MIS-189S Generator Elevator selector
OS-52B	297B2	Selector Tape , 1" Wide, Plain no perforations, for Otis Selectors
OS-52C	AA00279AAA001	Selector Tape , 2" Wide, for Otis SPT Floating Tape Device
OS-52D	AAA297AV1	Selector Tape , 3-15/16" Wide, Otis AAA22439AAF Application
PR-77A	RP010012 OBS	Relay , SPST 12VDC 10A PCB Socket Mount for IP8300 Selector
GS-2A		Selector Segment , Bottom Half for #3
GS-2B	SEL-0023N	Selector Holder Assembly , Segment (GS-2 & GS-2A)
HL-010	LECSELMTG	Selector Mounting Kit , EMI Home Lift
HL-011		Selector Tape , 2" No Holes used on Home Lift
GS-3	GALX-0307N	Tape Guide , for GAL Selector
VMI-001		VMI Encoder Roller , Nylon with Shaft and Hardware
VMI-001A	890-0061-012	Wheel Encoder Selector , Toothed Belt Idler with Bolt, Nut Bushing, Flat Profile
VMI-002		Encoder , Toothed Pulley 4-3/4" O.D.
VMI-003		VMI Encoder for Silent Move, WDGA58B-V
MIS-600		Tape Guide , for motion control
MIS-601		Tape Guide , with CS Holes
MIS-TG-001		Tape Guide , Mid America, 4 Slot 1-1/4" x 1" w/ (2) 0.200" Dia Holes



MIS-234



MIS-235



MIS-600



MIS-601

Reynolds Door Speed Controllers

S.E.E.S. #	Description
RDSC-001	Door Speed Controller, DC-2000, 60-160/240V
RDSC-001A	Door Speed Controller PCB, Replacement Board for RDSC-001
RDSC-002	Door Speed Controller, DC-244, 160-255V
RDSC-002A	Door Speed Controller PCB, Replacement Board for RDSC-002
RDSC-003	Door Speed Controller, DC-6970, 105-160V
RDSC-003A	Door Speed Controller PCB, Replacement Board for RDSC-003

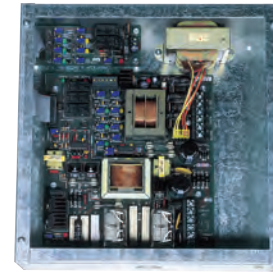

RDSC-001



RDSC-002



RDSC-002A



RDSC-003

Drive Units

S.E.E.S. #	Description
KB-9661	Drive, KBDA 48-5HP 380-460
KB-9661A	Input/Output Module for KB-9661
MCE-DRIVE-001	Elevator Drive MD F5A with DYB Unit (Car B)
MIS-DRIVE-001	Unidrive with Pot, 460 VAC, 9.4A (5HP), Heavy Duty - 9.4A (5)



KB-9661



MCE-DRIVE-001

Cables, Splitters & Filters

S.E.E.S. #	Description
SEES-CAT5-01	Cat5 Cable, 1 FT
SEES-CAT5-05	Cat5 Cable, 5 FT
SEES-CAT5-14	Cat5 Cable, 14 FT
SEES-CAT5-25	Cat5 Cable, 25 FT
SEES-CAT5-SPLIT	Cat5 Splitter, 1-2
MIS-3PLF-001	Line Filter, 3 Phase, 42A, Chassis Mount



MIS-3PLF-001

Fans

S.E.E.S. #	O.E.M. #	Description
MCE-001	USP24255	Fan Kit, for Miprom Cabinet 115V 105CFM Tubeaxial fan
MCE-002		Fan Kit, Axial, 120 x 38mm, 240 VDC wire
MAGNA-FAN-001		Magnetek Kit
MAGNA-FAN-002	HPV9FAN1A	Magnetek Kit
MRP-50	US90507	Fan, 127 CFM 230 VAC 50/60 hz enclosed 4-1/2" SQ.



MCE-001



MCE-002



MAGNA-FAN-001



MAGNA-FAN-002



MRP-50



Pipe



Pipe

S.E.E.S. #	Description
Victaulic to Victaulic	
SEES-PIPE-2080-004-VV	Pipe, 2" Sch 80 4" L, victaulic to victaulic
SEES-PIPE-2080-006-VV	Pipe, 2" Sch 80 6" L, victaulic to victaulic
SEES-PIPE-2080-008-VV	Pipe, 2" Sch 80 8" L, victaulic to victaulic
SEES-PIPE-2080-010-VV	Pipe, 2" Sch 80 10" L, victaulic to victaulic
SEES-PIPE-2080-012-VV	Pipe, 2" Sch 80 12" L, victaulic to victaulic
SEES-PIPE-2080-024-VV	Pipe, 2" Sch 80 24" L, victaulic to victaulic
SEES-PIPE-2080-036-VV	Pipe, 2" Sch 80 36" L, victaulic to victaulic
SEES-PIPE-2080-048-VV	Pipe, 2" Sch 80 48" L, victaulic to victaulic
SEES-PIPE-2080-060-VV	Pipe, 2" Sch 80 60" L, victaulic to victaulic
SEES-PIPE-2080-10-VV	Pipe, 2" Sch 80 Vic-Vic Ends, 10' Length
SEES-PIPE-2080-240-VV	Pipe, 2" Sch 80 240" L, Vic-Vic 21' Length
SEES-PIPE-2080-21-VV	Pipe, 2" Sch 80 Vic-Vic Ends, 21' Length
SEES-PIPE-2580-016-VV	Pipe, 2-1/2" Sch80 Vic-Vic Ends, 16" Length
SEES-PIPE-2580-025-VV	Pipe, 2-1/2" Sch80 Vic-Vic Ends, 25" Length
SEES-PIPE-2580-031-VV	Pipe, 2-1/2" Sch80 Vic-Vic Ends, 31" Length
SEES-PIPE-2580-036-VV	Pipe, 2-1/2" Sch80 Vic-Vic Ends, 36" Length
SEES-PIPE-2580-042-VV	Pipe, 2-1/2" Sch80 Vic-Vic Ends, 42" Length
SEES-PIPE-2580-043-VV	Pipe, 2-1/2" Sch80 Vic-Vic Ends, 43" Length
SEES-PIPE-2580-048-VV	Pipe, 2-1/2" Sch80 Vic-Vic Ends, 48" Length
SEES-PIPE-2580-054-VV	Pipe, 2-1/2" Sch80 Vic-Vic Ends, 54" Length
SEES-PIPE-2580-104-VV	Pipe, 2-1/2" Sch80 Vic-Vic Ends, 104" Length
SEES-PIPE-2580-10-VV	Pipe, 2-1/2" Sch80 Vic-Vic Ends, 10' Length
Victaulic to Threaded	
SEES-PIPE-2080-004-VT	Pipe, 2" Sch 80 4" L, victaulic to threaded
SEES-PIPE-2080-006-VT	Pipe, 2" Sch 80 6" L, victaulic to threaded
SEES-PIPE-2080-008-VT	Pipe, 2" Sch 80 8" L, victaulic to threaded
SEES-PIPE-2080-010-VT	Pipe, 2" Sch 80 10" L, victaulic to threaded
SEES-PIPE-2080-012-VT	Pipe, 2" Sch 80 12" L, victaulic to threaded
SEES-PIPE-2080-024-VT	Pipe, 2" Sch 80 24" L, victaulic to threaded
SEES-PIPE-2080-036-VT	Pipe, 2" Sch 80 36" L, victaulic to threaded
SEES-PIPE-2080-048-VT	Pipe, 2" Sch 80 48" L, victaulic to threaded
SEES-PIPE-2080-060-VT	Pipe, 2" Sch 80 60" L, victaulic to threaded
Threaded to Threaded	
SEES-PIPE-2080-004-TT	Pipe, 2" Sch 80 4" L, threaded to threaded
SEES-PIPE-2080-006-TT	Pipe, 2" Sch 80 6" L, threaded to threaded
SEES-PIPE-2080-008-TT	Pipe, 2" Sch 80 8" L, threaded to threaded
SEES-PIPE-2080-010-TT	Pipe, 2" Sch 80 10" L, threaded to threaded
SEES-PIPE-2080-012-TT	Pipe, 2" Sch 80 12" L, threaded to threaded
SEES-PIPE-2080-024-TT	Pipe, 2" Sch 80 24" L, threaded to threaded
SEES-PIPE-2080-036-TT	Pipe, 2" Sch 80 36" L, threaded to threaded
SEES-PIPE-2080-048-TT	Pipe, 2" Sch 80 48" L, threaded to threaded
SEES-PIPE-2080-060-TT	Pipe, 2" Sch 80 60" L, threaded to threaded
SEES-PIPE-2080-10-TT	Pipe, 2" Sch 80 Thrd-Thrd Ends, 10' Length
SEES-PIPE-2080-21-TT	Pipe, 2" Sch 80 Thrd-Thrd Ends, 21' Length
Plain Ends	
SEES-PIPE-2080-10	Pipe, 2" Sch 80 Plain Ends, 10' Length
SEES-PIPE-2080-21	Pipe, 2" Sch 80 Plain Ends, 21' Length
Custom Length	
SEES-PIPE-2080-SPECIAL	Pipe, 2" Sch 80, Special Length

Pipe

Couplings

S.E.E.S. #	O.E.M. #	Description
SEES-HYD-FIT-300-01	69104	Elbow , 3/4" Black Pipe Class 300
SEES-HYD-FIT-300-02	69105	Elbow , 1" Black Pipe Class 300
SEES-HYD-FIT-300-03	69108	Elbow , 2" Black Pipe Class 300
SEES-HYD-FIT-300-04	69414	Coupling , 3/4" Black Pipe Class 300
SEES-HYD-FIT-300-05	69105	Coupling , 1" Black Pipe Class 300
SEES-HYD-FIT-300-06	69418	Coupling , 2" Black Pipe Class 300
SEES-HYD-FIT-300-07	69442	Reducer , 3/4" x 1" Black Pipe Class 300
SEES-HYD-FIT-300-08	69254	Tee , 3/4" Black Pipe Class 300
SEES-HYD-FIT-300-09	69255	Tee , 1" Black Pipe Class 300
SEES-HYD-FIT-300-10	69258	Tee , 2" Black Pipe Class 300
SEES-HYD-FIT-300-11	69604	Union , 3/4" Brass Seat Class 300
SEES-HYD-FIT-300-12	69605	Union , 1" Brass Seat Class 300
SEES-HYD-FIT-300-13	69608	Union , 2" Brass Seat Class 300

Clamps

S.E.E.S. #	O.E.M. #	Description
HYD-CLAMP-001	9702003	Clamp , Hose 2-3/8"
HYD-CLAMP-002	9702027	Clamp , Hose 3-1/2"
HYD-CLAMP-003	9701990	Clamp , Hose 1-7/8"
HYD-CLAMP-004	9702015	Clamp , Hose C 2-7/8" x 3-3/4"
HYD-CLAMP-005	9702404	Clamp , Hose 5-1/2"

Ask about SEES custom threading and grooving.



SEES Now Offers Flavesco Elevator Machine Guarding



Guard your investment with Flavesco top of class guarding products designed with emphases on the end user's needs and benefits. Safety standards are progressing rapidly and an increased awareness of the importance of machine guarding has highlighted the need to have a solution available on the market. Whether installed as part of a new installation or part of a modernization, every guarding product that Flavesco offers is designed in accordance with CSA Z432-04, ANSI B11 and OSHA standards.

Flavesco elevator machine guarding sets are lightweight, simple to install, user-friendly, and come interlock ready. Every guarding set offers a multitude of access points to ensure that inspection and maintenance times are not impacted as a result of machine guarding. In addition, every product is guaranteed to pass any safety inspection.

Safety With Minimal Impact On Ease Of Maintenance

Flavesco is regarded as being the leading provider of elevator equipment component guarding. Incorporated in 2009, Flavesco has designed and developed component guarding sets for over 75 different machine types that were installed on more than 1700 machines coast to coast. Our mission, is to design and manufacture a top of the class product with emphases on the end user's needs and benefits.

Flavesco takes great pride in providing a product that meets and exceeds the end user's needs. By maintaining a consistent feedback loop with mechanics and inspectors, Flavesco is able to fine tune designs to ensure only the best quality products are delivered. Every time a new machine is encountered it gets 3D scanned and added to a database (currently includes over 75 different machine types). This provides critical information required to ensure an optimal fit which is invaluable as machine rooms are often limited in space.

PRODUCT DESIGN PROCESS



Benefits

SAFER WORKING ENVIRONMENT

Compliant guarding provides the secondary layer of protection necessary to properly minimize the risk involved with working in an elevator machine room.

PROTECT INVESTMENT

On-demand access to moving components of machine equipment not only limits a worker's exposure to hazards but it also protects the equipment from being damaged by accidental contact with foreign objects.

REDUCE LIABILITY

Rest easy knowing that OSHA compliant guarding has been installed with a guarantee to pass safety inspections. Ask us about how we should proceed regarding inspection sheets.

Safety standards are progressing rapidly and an increased awareness of the importance of machine guarding has highlighted the need to have a solution available on the market.

Whether installed as part of a new installation or part of a modernization, every Flavesco guarding product is designed in accordance with CSA Z432-04, ANSI B11 and OSHA standards.

Flavesco elevator machine guarding sets are lightweight, simple to install, user-friendly, and come interlock ready. Every guarding set offers a multitude of access points to ensure there is no impact on inspection and maintenance times.

Our design team has placed simplicity of installation as a top design priority. By implementing and including the following design features and documentation Flavesco ensures a smooth and quick installation.

- Standardized fasteners minimize requirement for different sizes simplifying installation
- Self-tapping fasteners used for frame attachment; fast and secure
- 2-4h typical installation time
- Full color installation manual & installation drawings
- Full remote installation support at no additional charge



SEES-FGS-OT219



SEES-FGS-OT072



SEES-FGS-HW5XO



SEES-FGS-OT13X



Standard Flavesco Elevator Machine Guarding



Hollister-Whitney Machine Guarding Sets

S.E.E.S. #	Description
SEES-FGS-HW34O	Guarding Set For Hollister-Whitney 34 OH Machine
SEES-FGS-HW4XO	Guarding Set For Hollister-Whitney 4X OH Machine
SEES-FGS-HW5XO	Guarding Set For Hollister-Whitney 5X OH Machine
SEES-FGS-HW6XO	Guarding Set For Hollister-Whitney 6X OH Machine

This list contains only the common machines, for full listing contact us!

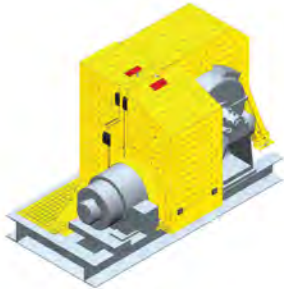

SEES-FGS-HW4XO

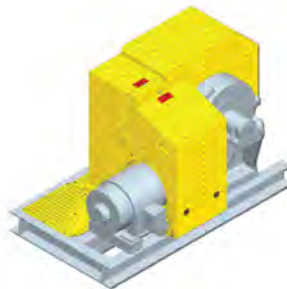

SEES-FGS-HW5XO

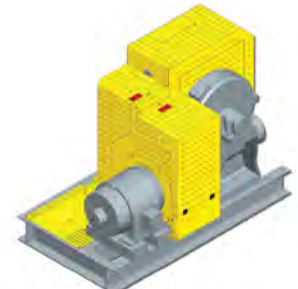

SEES-FGS-HW6XO

Otis Machine Guarding Sets

S.E.E.S. #	Description
SEES-FGS-OT072	Guarding Set For Otis 72 Machine
SEES-FGS-OT13X	Guarding Set For Otis 131/139 Machine
SEES-FGS-OT155	Guarding Set For Otis 155 Machine
SEES-FGS-OT219	Guarding Set For Otis 219 Machine

This list contains only the common machines, for full listing contact us!



SEES-FGS-OT072



SEES-FGS-OT13X



SEES-FGS-OT219

KONE Machine Guarding Sets

S.E.E.S. #	Description
SEES-FGS-MX018	Guarding Set For KONE MX18 Machine
SEES-FGS-MX032	Guarding Set For KONE MX32 Machine
SEES-FGS-MX040	Guarding Set For KONE MX40 Machine

This list contains only the most common machines, for full listing contact us!



SEES-FGS-MX018



SEES-FGS-MX032



SEES-FGS-MX040

Thyssenkrupp Machine Guarding Sets

S.E.E.S. #	Description
SEES-FGS-DAB53	Guarding Set For Thyssenkrupp DAB 530 Machine
SEES-FGS-DAF38	Guarding Set For Thyssenkrupp DAF 380 Machine
SEES-FGS-TW340	Guarding Set For Thyssenkrupp TW 340 Machine

This list contains only the common machines, for full listing contact us!



SEES-FGS-DAB53



SEES-FGS-DAF38



SEES-FGS-TW340

Introducing...
**THE WORLD'S BEST ELEVATOR
SCREWDRIVER**

\$15
FOR 1

\$12
FOR 10
OR MORE

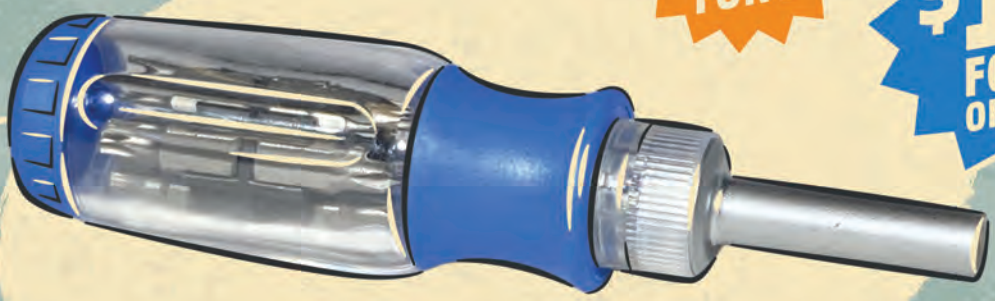

MIS-126A
*Screwdriver with
Ratchet & 12 Bits*

*Don't miss this
incredible DEAL!!!*



Phillips #0, #1, #2

Slotted #4

Spanner #6 x #8, #10 x #12

Torx(R) T10 x T15, T20 x T25



Always Smooth Sailing

2781 West McNab Rd, Pompano Beach, FL 33069 • (800) 526-0026 • www.SEEInc.com

DOORS / DOOR PARTS

QUICK LOCATOR GUIDE

Aircraft Cable	248
Astragals	230-231
Belts	254
Car Sills	241
Doors	243-246
Doors for Residential Elevators	242
Door Gibs / Door Bumpers	232-236
Door Keys	250-251
Door Latch Assembly	260
Door Restrictor	261
Door Roller Guide Kits	236
Door Wedge Tools	240
Electric Eye Assemblies	255
Escutcheons	253-254
Fire Tabs	238
Freight Straps	248
Guards, Toe/Platform	239
Hatch Exit	260
Hatch Sills	241
Safety Edge	255-257
SEEScreen	255-257
SEES Door Wedge Tool	240
SEES Enforcer	232-233
SEES Light Curtain	255
SEES Restrictor	261
SEES Z-Brackets	238
Sills	241
Spirators, Reel Closers	249
Top Retainers	261-262
Z Brackets	238

Astragals

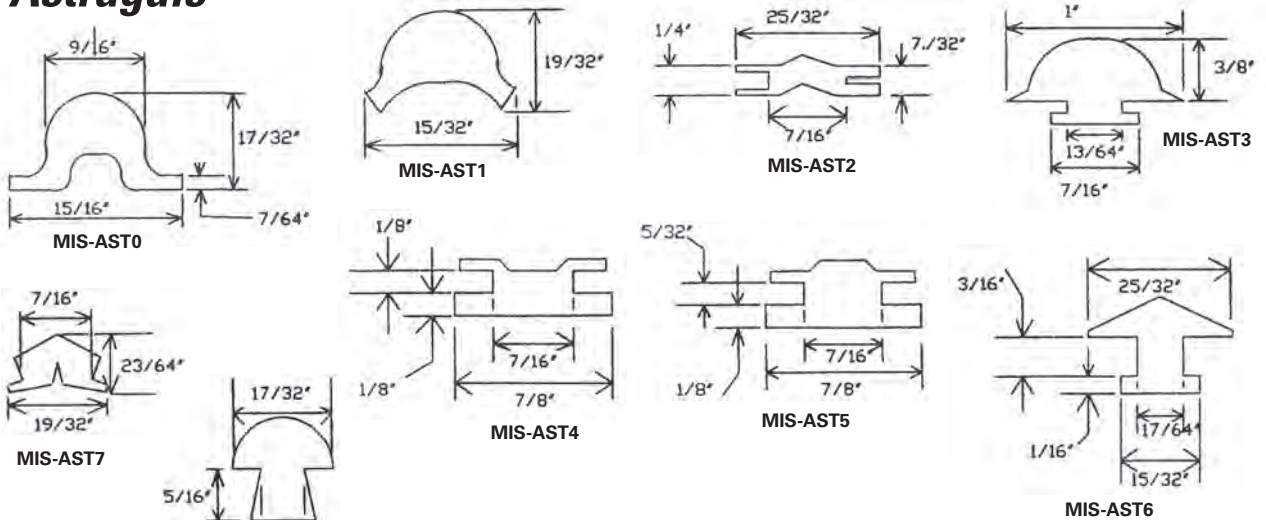

S.E.E.S. #	Description
MIS-AST0	Astragal, Door, #100, replacement for Hoistway, 8 ft. section
MIS-AST0A	Astragal, Door, #100, replacement for Hoistway, 10 ft. section
MIS-AST1	Astragal, Door, #101, side opening, 8 ft. section
MIS-AST1A	Astragal, Door, #101, side opening, 10 ft. section
MIS-AST2	Astragal, Door, #102, reversing, 8 ft. section
MIS-AST2A	Astragal, Door, #102, reversing, 10 ft. section
MIS-AST3	Astragal, Door, #103, side opening, 8 ft. section
MIS-AST3A	Astragal, Door, #103, side opening, 10 ft. section
MIS-AST4	Astragal, Door, #104, companion part to MIS-AST5, 8 ft. section
MIS-AST4A	Astragal, Door, #104, companion part to MIS-AST5A, 10 ft. section
MIS-AST5	Astragal, Door, #105, companion part to MIS-AST4, 8 ft. section
MIS-AST5A	Astragal, Door, #105, companion part to MIS-AST4A, 10 ft. section
MIS-AST6	Astragal, Door, #106, 8 ft. section
MIS-AST6A	Astragal, Door, #106, 10 ft. section
MIS-AST7	Astragal, Door, #107, side opening, 8 ft. section
MIS-AST7A	Astragal, Door, #107, side opening, 10 ft. section
MIS-AST8	Astragal, Door, #108, side opening, 8 ft. section
MIS-AST8A	Astragal, Door, #108, side opening, 10 ft. section
MIS-AST9	Astragal, Door, #109, reversing, replacement for Otis & Esco, 8 ft. section
MIS-AST9A	Astragal, Door, #109, reversing, replacement for Otis & Esco, 10 ft. section
MIS-AST10	Astragal, Door, #110, fits 7/16" groove, 8 ft. section
MIS-AST10A	Astragal, Door, #110, fits 7/16" groove, 10 ft. section
MIS-AST11	Astragal, Door, #111, reversing 3/8" groove, 8 ft. section
MIS-AST11A	Astragal, Door, #111, reversing 3/8" groove, 10 ft. section
MIS-AST12	Astragal, Door, #112, side opening, 8 ft. section
MIS-AST12A	Astragal, Door, #112, side opening, 10 ft. section
MIS-AST15	Astragal, Door, #115, companion part to MIS-AST16, 8 ft. section
MIS-AST15A	Astragal, Door, #115, companion part to MIS-AST16, 10 ft. section
MIS-AST16	Astragal, Door, #116, companion part to MIS-AST15, 8 ft. section
MIS-AST16A	Astragal, Door, #116, companion part to MIS-AST15, 10 ft. section
MIS-AST17	Astragal, Door, #117, side opening, 8 ft. section
MIS-AST17A	Astragal, Door, #117, side opening, 10 ft. section
MIS-AST18	Astragal, reversing 8 ft. length
MIS-AST18A	Astragal, reversing 10 ft. length
MIS-AST19	Astragal, Door, #119, glue on replacement, 8 ft. section
MIS-AST19A	Astragal, Door, #119, glue on replacement, 10 ft. section

S.E.E.S. #	Description
MIS-AST0	Astragal, Door, #100, replacement for Hoistway, 8 ft. section
MIS-AST0A	Astragal, Door, #100, replacement for Hoistway, 10 ft. section
MIS-AST1	Astragal, Door, #101, side opening, 8 ft. section
MIS-AST1A	Astragal, Door, #101, side opening, 10 ft. section
MIS-AST2	Astragal, Door, #102, reversing, 8 ft. section
MIS-AST2A	Astragal, Door, #102, reversing, 10 ft. section
MIS-AST3	Astragal, Door, #103, side opening, 8 ft. section
MIS-AST3A	Astragal, Door, #103, side opening, 10 ft. section
MIS-AST4	Astragal, Door, #104, companion part to MIS-AST5, 8 ft. section
MIS-AST4A	Astragal, Door, #104, companion part to MIS-AST5A, 10 ft. section
MIS-AST5	Astragal, Door, #105, companion part to MIS-AST4, 8 ft. section
MIS-AST5A	Astragal, Door, #105, companion part to MIS-AST4A, 10 ft. section
MIS-AST6	Astragal, Door, #106, 8 ft. section
MIS-AST6A	Astragal, Door, #106, 10 ft. section
MIS-AST7	Astragal, Door, #107, side opening, 8 ft. section
MIS-AST7A	Astragal, Door, #107, side opening, 10 ft. section
MIS-AST8	Astragal, Door, #108, side opening, 8 ft. section
MIS-AST8A	Astragal, Door, #108, side opening, 10 ft. section
MIS-AST9	Astragal, Door, #109, reversing, replacement for Otis & Esco, 8 ft. section
MIS-AST9A	Astragal, Door, #109, reversing, replacement for Otis & Esco, 10 ft. section
MIS-AST10	Astragal, Door, #110, fits 7/16" groove, 8 ft. section
MIS-AST10A	Astragal, Door, #110, fits 7/16" groove, 10 ft. section
MIS-AST11	Astragal, Door, #111, reversing 3/8" groove, 8 ft. section
MIS-AST11A	Astragal, Door, #111, reversing 3/8" groove, 10 ft. section
MIS-AST12	Astragal, Door, #112, side opening, 8 ft. section
MIS-AST12A	Astragal, Door, #112, side opening, 10 ft. section
MIS-AST15	Astragal, Door, #115, companion part to MIS-AST16, 8 ft. section
MIS-AST15A	Astragal, Door, #115, companion part to MIS-AST16, 10 ft. section
MIS-AST16	Astragal, Door, #116, companion part to MIS-AST15, 8 ft. section
MIS-AST16A	Astragal, Door, #116, companion part to MIS-AST15, 10 ft. section
MIS-AST17	Astragal, Door, #117, side opening, 8 ft. section
MIS-AST17A	Astragal, Door, #117, side opening, 10 ft. section
MIS-AST18	Astragal, reversing 8 ft. length
MIS-AST18A	Astragal, reversing 10 ft. length
MIS-AST19	Astragal, Door, #119, glue on replacement, 8 ft. section
MIS-AST19A	Astragal, Door, #119, glue on replacement, 10 ft. section

* Please call if your required Astragal is not listed

Astragals

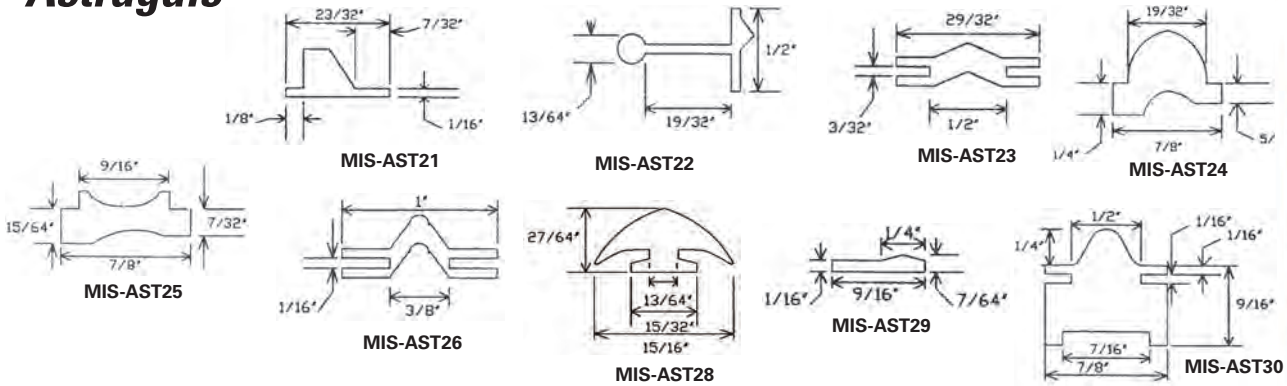

S.E.E.S. #	Description
MIS-AST21	Astragal, Door, #121, side opening, 8 ft. section
MIS-AST21A	Astragal, Door, #121, side opening, 10 ft. section
MIS-AST22	Astragal, Door, #122, reversing, 8 ft. section
MIS-AST22A	Astragal, Door, #122, reversing, 10 ft. section
MIS-AST23	Astragal, Door, #123, reversing, 8 ft. section
MIS-AST23A	Astragal, Door, #123, reversing, 10 ft. section
MIS-AST24	Astragal, Door, #124, companion part to MIS-AST25, 8 ft. section
MIS-AST24A	Astragal, Door, #124, companion part to MIS-AST25A, 10 ft. section
MIS-AST25	Astragal, Door, #125, companion part to MIS-AST24, 8 ft. section
MIS-AST25A	Astragal, Door, #125, companion part to MIS-AST24A, 10 ft. section
MIS-AST26	Astragal, Door, #126, reversing, 8 ft. section
MIS-AST26A	Astragal, Door, #126, reversing, 10 ft. section
MIS-AST28	Astragal, Door, #128, side opening, 8 ft. section
MIS-AST28A	Astragal, Door, #128, side opening, 10 ft. section
MIS-AST29	Astragal, Door, #129, 8 ft. section
MIS-AST29A	Astragal, Door, #129, 10 ft. section
MIS-AST30	Astragal, Door, #130, companion part to MIS-AST31, 8 ft. section
MIS-AST30A	Astragal, Door, #130, companion part to MIS-AST31A, 10 ft. section
MIS-AST31	Astragal, Door, #131, companion part to MIS-AST30, 8 ft. section
MIS-AST31A	Astragal, Door, #131, companion part to MIS-AST30A, 10 ft. section
MIS-AST32	Astragal, Door, #132, reversing, 8 ft. section
MIS-AST32A	Astragal, Door, #132, reversing, 10 ft. section
MIS-AST32-EXT7	Astragal Excursion, 7ft.
MIS-AST33	Astragal, Mates to MIS-AST34, 8 ft.
MIS-AST33A	Astragal, Mates to MIS-AST34A, 10 ft.
MIS-AST34	Astragal, Mates to MIS-AST33, 8 ft.
MIS-AST34A	Astragal, Mates to MIS-AST33A, 10 ft.
MIS-AST41	Astragal, 8 Ft. .625 x .425 x .905
MIS-AST45	Astragal, 8 Ft. .6875 x .5 x .625, 145-08
MIS-AST45A	Astragal, 10 Ft. .6875 x .5 x .625, 145-10
MIS-AST47	Astragal, used on #47 elevator equipment 8 ft.
MIS-AST48	Astragal (universal) self adhesive, sold per foot
MIS-AST49	Astragal, Dover 8' Section
MIS-AST50	Astragal, Montgomery Stay 80 84.5" Section
MIS-AST146	Astragal, #146, 9/16 x 11/32 x 15/32, 8' Section
MIS-AST148	Astragal, #148 8' Section
MIS-AST148A	Astragal, #148, 10' Section
MIS-AST149	Astragal, 8 Ft. .688 x .5 x .937
MIS-AST150	Astragal, 8 Ft. .688 x .562 x .938
MIS-AST001A	Astragal, Dual Slot 10' Reversible
MIS-AST200	Astragal, T Profile 108-1/2" Long
MIS-AST32-EXT7	Astragal, 7ft.

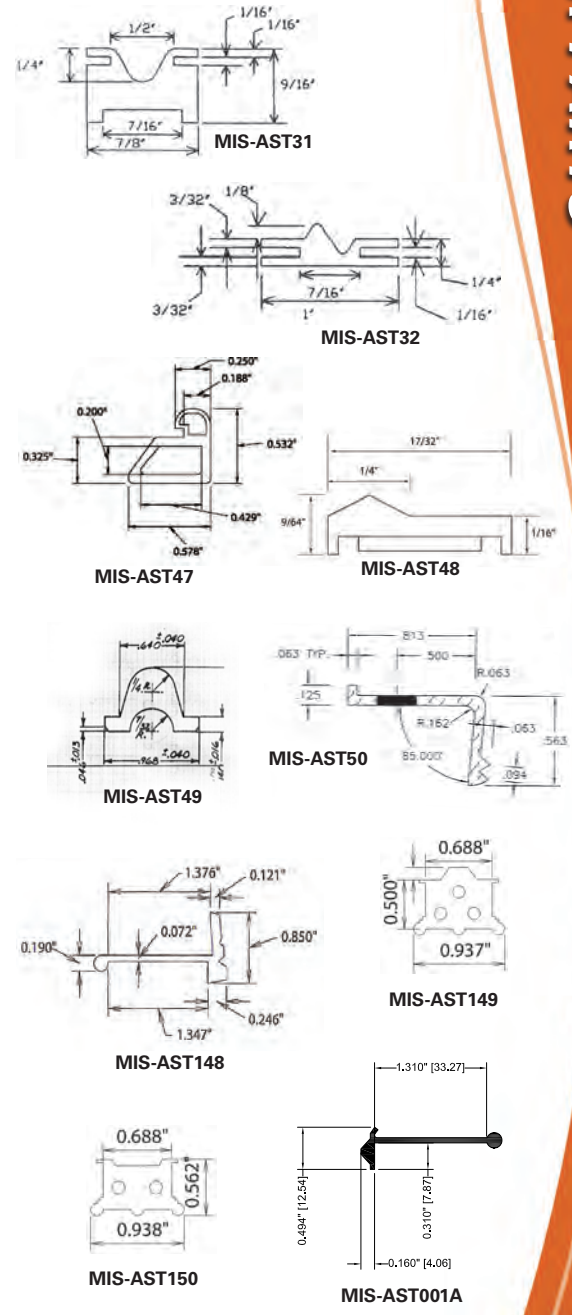

* Please call if your required Astragal is not listed



The Enforcer

Door Gibs. Redefined.

SEES-ENFORCER-001
7/16"SEES-ENFORCER-002
15/32"SEES-ENFORCER-003
1/2"SEES-ENFORCER-004
17/32"

SEES Enforcer Door Gib Kits

S.E.E.S. #	Description
SEES-ENFORCER-001	SEES Safety Door Guide, Heavy Duty, Stainless Steel, Adjustable guide, with 7/16" nylon gib, minimum offset: .312" maximum offset: .968"
SEES-ENFORCER-002	SEES Safety Door Guide, Heavy Duty, Stainless Steel, Adjustable guide, with 15/32" nylon gib, minimum offset: .312" maximum offset: .968"
SEES-ENFORCER-003	SEES Safety Door Guide, Heavy Duty, Stainless Steel, Adjustable guide, with 1/2" nylon gib, minimum offset: .312" maximum offset: .968"
SEES-ENFORCER-004	SEES Safety Door Guide, Heavy Duty, Stainless Steel, Adjustable guide, with 17/32" nylon gib, minimum offset: .312" maximum offset: .968"
SEES-ENFORCER-010	SEES Safety Door Guide, Heavy Duty, Stainless Steel, Adjustable guide, with 23/64" nylon gib, minimum offset: .312" maximum offset: .968"
SEES-ENFORCER-FT	Door Gib, Fire tab, Stainless Steel
SEES-ENFORCER-GIB-001	Replacement Door Gib, Nylon, 7/16" wide
SEES-ENFORCER-GIB-002	Replacement Door Gib, Nylon, 15/32" wide
SEES-ENFORCER-GIB-003	Replacement Door Gib, Nylon, 1/2" wide
SEES-ENFORCER-GIB-004	Replacement Door Gib, Nylon, 17/32" wide
SEES-ENFORCER-GIB-010	Replacement Door Gib, Nylon, 23/64" wide
SEES-ENFORCER-HDW	Bag Of 50 Mounting Screws for Enforcer Door Gib
SEES-ENFORCER-LP-R	SEES Safety Door Guide, Stainless Steel, Low Profile (Red) Adjustable guide, w/ 7/16" nylon gib

Features

- Manufactured in durable 304 Stainless Steel for 100% rust resistance
- Serrated grip locks into place and ensures stability
- Easy installation and field time savings with fully adjustable built in safety retainers and bar guides
- Engineered to greatly reduce risk of door and door sill dislodgment
- Versatile design fits most existing mounting holes
- Improved safety design addresses impact loads placed on lower elevator door
- Passed impact testing at 400ft-lbf
- Can handle 18,000 lbs of force



SEES-ENFORCER-GIB-001



SEES-ENFORCER-GIB-002



SEES-ENFORCER-GIB-003



SEES-ENFORCER-GIB-004



SEES-ENFORCER-010



SEES-ENFORCER-FT

Enforcer EDGE



SEES-ENFORCER-EDGE-G

SEES Enforcer EDGE

S.E.E.S. #	Description
SEES-ENFORCER-EDGE-G	SEES Safety Door Guide, Stainless Steel, 0"-1" Offset with Green 15/32" Gib
SEES-ENFORCER-EDGE-R	SEES Safety Door Guide, Stainless Steel, 0"-1" Offset with Red 7/16" Gib
SEES-ENFORCER-EDGE-W	SEES Safety Door Guide, Stainless Steel, 0"-1" Offset with White 1/2" Gib
SEES-ENFORCER-EDGE-B	SEES Safety Door Guide, Stainless Steel, 0"-1" Offset with Blue 17/32" Gib

■ Great for Westinghouse & Otis elevators with little to no offset

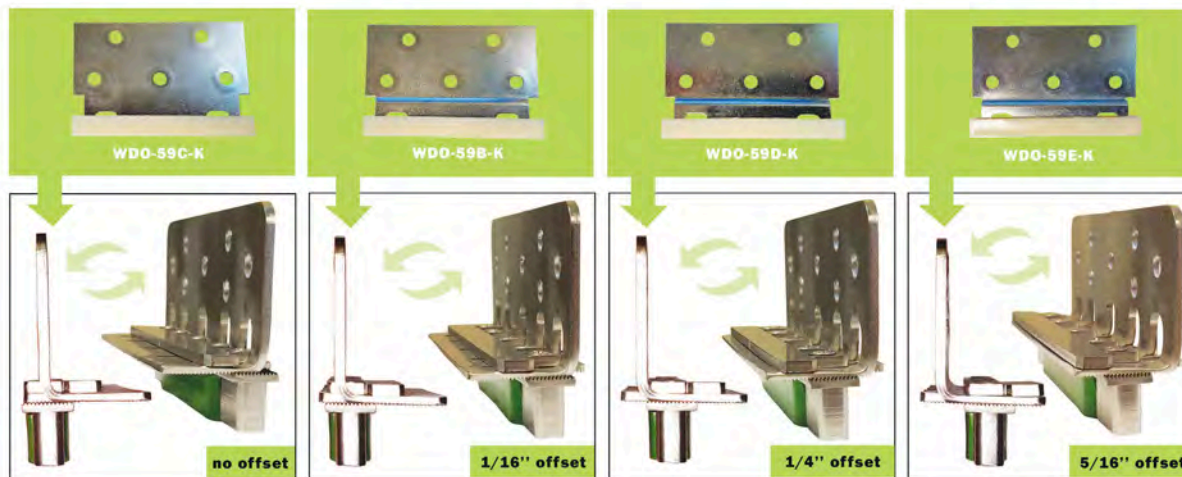

EPCO Door Gib Kits

S.E.E.S. #	O.E.M. #	Description
EPCO-GIB-BR	BR	Door Gib, Adjustable roller bearing
EPCO-GIB-C	C	Door Gib, Adjustable 15/32" W white nylon
EPCO-GIB-CD-3	CD-3	Door Gib & Chassis, 15/32" W white nylon with 1" W Chassis
EPCO-GIB-CD-4	CD-4	Door Gib & Chassis, 15/32" W white nylon with 1-1/8" W Chassis
EPCO-GIB-CD-5	CD-5	Door Gib & Chassis, 15/32" W white nylon with 1-1/4" W Chassis



EPCO-GIB-BR



EPCO-GIB-CD-3

Door Gibs/Door Bumpers

EPCO Door Gib Kits

S.E.E.S #	O.E.M. #	Description
EPCO-GIB-D-3	D-3	Door Gib Chassis, 1" W adjustable bracket
EPCO-GIB-D-4	D-4	Door Gib Chassis, 1-1/8" W adjustable bracket
EPCO-GIB-D-5	D-5	Door Gib Chassis, 1-1/4" W adjustable bracket
EPCO-GIB-MG	MG	Door Gib, Adjustable 7/16" W black nylon
EPCO-GIB-MGD-3	MGD-3	Door Gib & Chassis, 7/16" W black nylon with 1" W Chassis
EPCO-GIB-MGD-4	MGD-4	Door Gib & Chassis, 7/16" W black nylon with 1-1/4" W Chassis
EPCO-GIB-MGD-5	MGD-5	Door Gib & Chassis, 7/16" W black nylon with 1-1/8" W Chassis
EPCO-GIB-S	S	Door Gib, Adjustable 23/64" W yellow nylon
EPCO-GIB-SD-3	SD-3	Door Gib & Chassis, 23/64" W yellow nylon with 1" W Chassis
EPCO-GIB-SD-4	SD-4	Door Gib & Chassis, 23/64" W yellow nylon with 1-1/4" W Chassis
EPCO-GIB-SD-5	SD-5	Door Gib & Chassis, 23/64" W yellow nylon with 1-1/8" W Chassis
EPCO-GIB-T	T	Door Gib, Adjustable 1/2" W blue nylon
EPCO-GIB-TD-3	TD-3	Door Gib & Chassis, 1/2" W blue nylon with 1" W Chassis
EPCO-GIB-TD-4	TD-4	Door Gib & Chassis, 1/2" W blue nylon with 1-1/8" W Chassis
EPCO-GIB-TD-5	TD-5	Door Gib & Chassis, 1/2" W blue nylon with 1-1/4" W Chassis
EPCO-GIB-Z4	Z 4	Gib Bracket, 4Z bracket, 3/8" offset

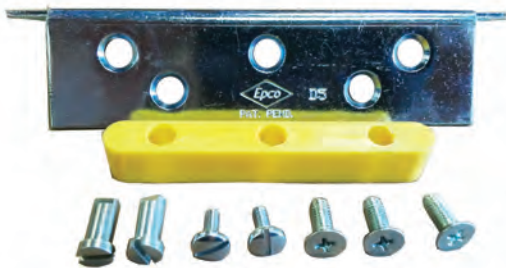

EPCO-GIB-SD-5

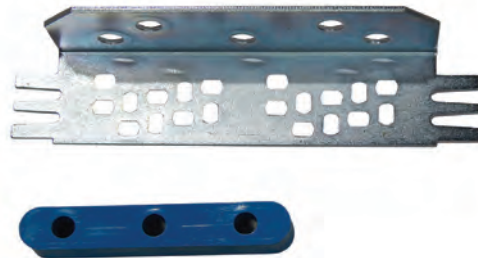

EPCO-GIB-TD-4



EPCO-GIB-TD-5



EPCO-GIB-Z4



MIS-146



MIS-146B

Door Gibs and Gib Kits

S.E.E.S. #	Description
MIS-146	Gib Kit , 15/32", includes bracket (4-1/2"), gib (Green, 2-3/4" L) and hardware. Two fire tabs. Replacement gib MIS-146A
MIS-146A	Gib , Nylon, 15/32", Green replacement gib
MIS-146B	Gib Kit , 15/32", Heavy Duty, includes bracket, gib (Green, 2-3/4" L) and hardware. Three fire tabs. Replacement gib MIS-146A
MIS-146C	Gib Kit , 1/2", includes bracket, gib (White, 2-3/4" L) and hardware. Three fire tabs. Replacement gib MIS-146H
MIS-146H	Gib , Nylon, 1/2", White replacement gib
MIS-146F	Gib Kit , 7/16", includes bracket, gib (Red, 2-3/4" L) and hardware. Three hole mount. Replacement gib MIS-146G
MIS-146G	Gib , Nylon, 7/16", Red replacement gib
MIS-146-GG	Gib , replacement for A90, Door Gib Assy
MIS-146L-SS	Gib , Fire Tab 3/4" Offset, Stainless Steel
MIS-146D	Gib , Nylon, 7/16" sill slot width, 2 hole mount
MIS-146M	Gib Kit , 17/32", includes bracket, gib (Blue 2-3/4") and hardware. Two Fire Tabs. Replacement gib MIS-146I
MIS-146I	Gib , Nylon, 17/32", Blue replacement gib
MIS-146-FTB	Gib , Fire Tab Bracket for MIS-146 Series



MIS-146C



MIS-146F



MIS-146M



MIS-146-GG



MIS-146J

S.E.E.S. #	O.E.M. #	Description
MIS-146J	2976	Door Gib , Fire Tab kit, for 1/2" off set, 4" L, bracket and screws included
MIS-146K	2977	Door Gib , Fire Tab kit, for 5/8" off set, 4" L, bracket and screws included
MIS-146L		Door Gib , Fire Tab kit, 3/4" offset, 4" L, bracket and screws included
MIS-146J-NY	2926	Door Gib , Fire Tab, 1/2" Offset NY 10GA, 4" Long, with hardware
MIS-146K-NY	2927	Door Gib , Fire Tab, 5/8" Offset NY 10GA, 4" Long, with hardware
MIS-146L-NY	2920	Door Gib , Fire Tab, 3/4" Offset NY 10GA, 4" Long, with hardware
MIS-146N	2982	Door Gib , Fire Tab kit, 1/4" offset, 4" Long, with hardware
MIS-146P	2983	Door Gib , Fire Tab kit, 3/8" offset, 4" Long, with hardware
MIS-146Q	2979	Door Gib , Fire Tab kit, 7/8" offset, 4" Long, with hardware
MIS-146Q-NY	2929	Door Gib , Fire Tab, 7/8" Offset NY 10GA, 4" Long, with hardware
MIS-146R	2978	Door Gib , Fire Tab kit, 1" offset, 4" Long, with hardware
MIS-146R-NY	2928	Door Gib , Fire Tab, 1" Offset NY 10GA, 4" Long, with hardware
MIS-TYL-006		Door Gib , with mounting screw
MIS-TYL-006A		Door Gib , with brass insert & mounting screw
MIS-TYL-007		Door Gib Kit , gib, bracket & hardware



MIS-146K



MIS-146Q



MIS-146R

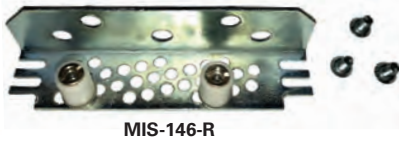

MIS-146-R



MIS-146-R1



MIS-146-R2



MIS-146-R3



MIS-146C-R1



MIS-146C-R2



MIS-146C-R3



MIS-146F-R



MIS-146F-R2



MIS-146F-R3

Door Roller Guide Kits

S.E.E.S. #	O.E.M. #	Description
MIS-146-R	DWR-2	Door Roller Guide Kit, 15/32", 2 Rollers, Door < or = 1"
MIS-146-R1	DLR-2	Door Roller Guide Kit, 15/32", 2 Rollers, Door 1" - 1.25"
MIS-146-R2	DWRH-2	Door Roller Guide Kit, 15/32", 3 Rollers, Door < or = 1"
MIS-146-R3	DLRH-2	Door Roller Guide Kit, 15/32", 3 Rollers, Door 1" - 1.25"
MIS-146C-R	DWR-3	Door Roller Guide Kit, 1/2", 2 Rollers, Door < or = 1"
MIS-146C-R1	DLR-3	Door Roller Guide Kit, 1/2", 2 Rollers, Door 1" - 1.25"
MIS-146C-R2	DWRH-3	Door Roller Guide Kit, 1/2", 3 Rollers, Door < or = 1"
MIS-146C-R3	DLRH-3	Door Roller Guide Kit, 1/2", 3 Rollers, Door 1" - 1.25"
MIS-146F-R	DWR-1	Door Roller Guide Kit, 7/16", 2 Rollers, Door < or = 1"
MIS-146F-R1	DLR-1	Door Roller Guide Kit, 7/16", 2 Rollers, Door 1" - 1.25"
MIS-146F-R2	DWRH-1	Door Roller Guide Kit, 7/16", 3 Rollers, < OR = 1"
MIS-146F-R3	DLRH-1	Door Roller Guide Kit, 7/16", 3 Rollers, 1" - 1.25"

Door Bumpers



MIS-157



MIS-157A

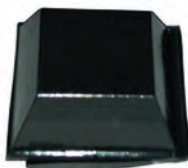

MIS-157B



MIS-157C

S.E.E.S. #	O.E.M. #	Description
MIS-157		Door Bumper, 1" O.D. x 1/2" Diameter, threaded stem
MIS-157A		Door Bumper, 1-1/4" square, self adhesive
MIS-157B		Door Bumper, 13/16" square x 1/4" thick, self adhesive, pack of 36
MIS-157C	G30B1	Door Bumper, Rubber 7/16" O.D. x 1/8" I.D. x 3/8" Long
MIS-157-HDW		Speed Nut for MIS-157, Bag of 10



Get your ZZZ's with SEES!

Please visit us in
Atlantic City at
Booth #1705!

Rest easy knowing your elevator door is secure with SEES Z-Brackets.



Ask About Our Poly-Coated
Sill Saver Z Brackets!

S.E.E.S. #	Description
SEES-FTZB-001	SEES FireTab Z-Bracket, 1/4" Offset, 8" lg, 11GA Galv Steel
SEES-FTZB-002	SEES FireTab Z-Bracket, 3/8" Offset, 8" lg, 11GA Galv Steel
SEES-FTZB-003	SEES FireTab Z-Bracket, 1/2" Offset, 8" lg, 11GA Galv Steel
SEES-FTZB-004	SEES FireTab Z-Bracket, 5/8" Offset, 8" lg, 11GA Galv Steel
SEES-FTZB-005	SEES FireTab Z-Bracket, 9/16" Offset, 8" lg, 11GA Galv Steel
SEES-FTZB-006	SEES FireTab Z-Bracket, 3/4" Offset, 8" lg, 11GA Galv Steel
SEES-FTZB-007	SEES FireTab Z-Bracket, 7/8" Offset, 8" lg, 11GA Galv Steel
SEES-FTZB-008	SEES FireTab Z-Bracket, 1" Offset, 8" lg, 11GA Galv Steel
SEES-FTZB-009	SEES FireTab Z-Bracket, 1-1/4" Offset, 8" lg, 11GA Galv Steel
SEES-FTZB-010	SEES FireTab Z-Bracket, 1-1/2" Offset, 8" lg, 11GA Galv Steel
SEES-FTZB-011	SEES FireTab Z-Bracket, 1-5/8" Offset, 8" lg, 11GA Galv Steel

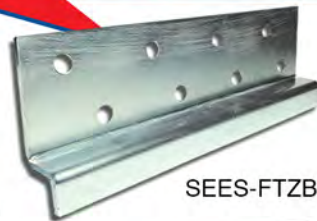

SEES-FTZB-004

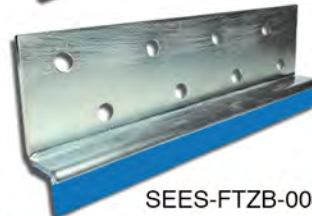

SEES-FTZB-004-P

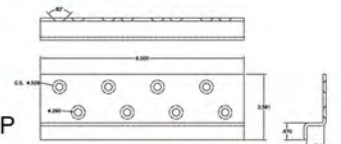

Always Smooth Sailing



Fire Tabs / Z Brackets

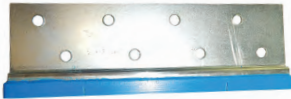

SEES-FTZB-001-P



SEES-FTZB-002-P



SEES-FTZB-003-P



SEES-FTZB-003-AP



SEES-FTZB-004-P



SEES-FTZB-012-A

S.E.E.S. #	Description
SEES-FTZB-000	SEES FireTab Z-Bracket, 0" Offset, 8" lg, 11GA Galv Steel
SEES-FTZB-000-P*	SEES Poly Z-Bracket, 0" Offset 8" lg, 11GA with Poly, poly width: 1/4"
SEES-FTZB-001	SEES FireTab Z-Bracket, 1/4" Offset, 8" lg, 11GA Galv Steel
SEES-FTZB-001-P*	SEES Poly Z-Bracket, 1/4" Offset, 8" lg, 11GA Galv Steel Poly, poly width: 1/4"
SEES-FTZB-001SS	SEES FireTab Z-Bracket, 1/4" Offset, 8" lg, 11GA 304 Stainless Steel
SEES-FTZB-001SS-B	SEES FireTab Z-Bracket, 1/4" Offset, 304SS
SEES-FTZB-002	SEES FireTab Z-Bracket, 3/8" Offset, 8" lg, 11GA Galv Steel
SEES-FTZB-002-P*	SEES Poly Z-Bracket, 3/8" Offset, 8" lg, 11GA Galv Steel Poly, poly width: 1/4"
SEES-FTZB-002SS	SEES FireTab Z-Bracket, 3/8" Offset, 8" lg, 11GA 304 Stainless Steel
SEES-FTZB-003	SEES FireTab Z-Bracket, 1/2" Offset, 8" lg, 11GA Galv Steel
SEES-FTZB-003-A	SEES FireTab Z-Bracket, 1/2" Offset, 4" lg 11GA Galv Steel
SEES-FTZB-003-AP	SEES FireTab Z-Bracket, 1/2" Offset, 4" lg 11GA Galv Steel, with Poly Guide, poly width: 1/4"
SEES-FTZB-003-P*	SEES Poly Z-Bracket, 1/2" Offset, 8" lg, 11GA Galv Steel Poly, poly width: 1/4"
SEES-FTZB-003SS	SEES FireTab Z-Bracket, 1/2" Offset, 8" lg, 11GA 304 Stainless Steel
SEES-FTZB-004	SEES FireTab Z-Bracket, 5/8" Offset, 8" lg, 11GA Galv Steel
SEES-FTZB-004-P*	SEES Poly Z-Bracket, 5/8" Offset, 8" lg, 11GA Galv Steel Poly, poly width: 1/4"
SEES-FTZB-004SS	SEES FireTab Z-Bracket, 5/8" Offset, 8" lg, 11GA 304 Stainless Steel
SEES-FTZB-005	SEES FireTab Z-Bracket, 9/16" Offset, 8" lg, 11GA Galv Steel, poly width: 1/4"
SEES-FTZB-005-P*	SEES Poly Z-Bracket, 9/16" Offset, 8" lg, 11GA Galv Steel Poly, poly width: 1/4"
SEES-FTZB-005SS	SEES FireTab Z-Bracket, 9/16" Offset, 8" lg, 11GA 304 Stainless Steel
SEES-FTZB-006	SEES FireTab Z-Bracket, 3/4" Offset, 8" lg, 11GA Galv Steel
SEES-FTZB-006-P*	SEES Poly Z-Bracket, 3/4" Offset, 8" lg, 11GA Galv Steel Poly, poly width: 1/4"
SEES-FTZB-006SS	SEES FireTab Z-Bracket, 3/4" Offset, 8" lg, 11GA 304 Stainless Steel
SEES-FTZB-007	SEES FireTab Z-Bracket, 7/8" Offset, 8" lg, 11GA Galv Steel
SEES-FTZB-007-A	SEES FireTab Z-Bracket, 7/8" Offset, 4" lg, 11GA Galv Steel
SEES-FTZB-007-P*	SEES Poly Z-Bracket, 7/8" Offset, 8" lg, 11GA Galv Steel Poly, poly width: 1/4"
SEES-FTZB-007SS	SEES FireTab Z-Bracket, 7/8" Offset, 8" lg, 11GA 304 Stainless Steel
SEES-FTZB-008	SEES FireTab Z-Bracket, 1" Offset, 8" lg, 11GA Galv Steel
SEES-FTZB-008-P*	SEES Poly Z-Bracket, 1" Offset, 8" lg, 11GA Galv Steel Poly, poly width: 1/4"
SEES-FTZB-008SS	SEES FireTab Z-Bracket, 1" Offset, 8" lg, 11GA 304 Stainless Steel
SEES-FTZB-009	SEES FireTab Z-Bracket, 1-1/4" Offset, 8" lg, 11GA Galv Steel
SEES-FTZB-009-P*	SEES Poly Z-Bracket, 1-1/4" Offset, 8" lg, 11GA Galv Steel Poly, poly width: 1/4"
SEES-FTZB-009SS	SEES FireTab Z-Bracket, 1-1/4" Offset, 8" lg, 11GA 304 Stainless Steel
SEES-FTZB-010	SEES FireTab Z-Bracket, 1-1/2" Offset, 8" lg, 11GA Galv Steel
SEES-FTZB-010-P*	SEES Poly Z-Bracket, 1-1/2" Offset, 8" lg, 11GA Galv Steel Poly, poly width: 1/4"
SEES-FTZB-010SS	SEES FireTab Z-Bracket, 1-1/2" Offset, 8" lg, 11GA 304 Stainless Steel
SEES-FTZB-011	SEES FireTab Z-Bracket, 1-5/8" Offset, 8" lg, 11GA Galv Steel
SEES-FTZB-011-P*	SEES Poly Z-Bracket, 1-5/8" Offset, 8" lg, 11GA Galv Steel Poly, poly width: 1/4"
SEES-FTZB-011SS	SEES FireTab Z-Bracket, 1-5/8" Offset, 8" lg, 11GA 304 Stainless Steel
SEES-FTZB-012-A	SEES FireTab Z-Bracket, 1-1/8" Offset, 4" lg 11GA Galv Steel with Hdw

* Poly Thickness: .250"

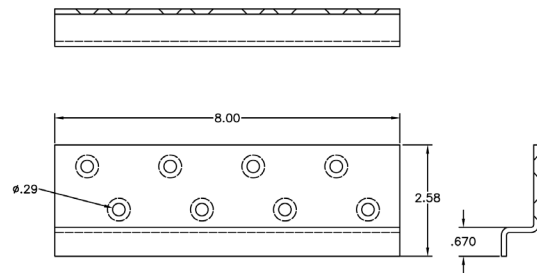
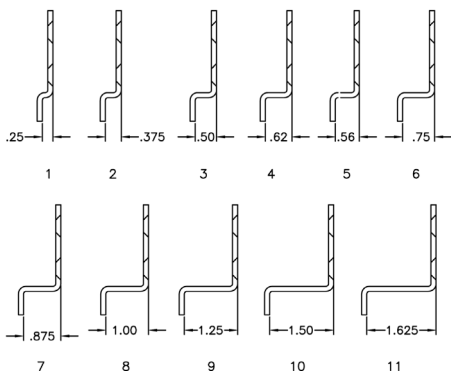

Platform Guards / Toe Guards

S.E.E.S. #	Description
SEES-PTG-36-026	Guard, Platform/Toe/Apron for 36" opening, Actual 36" x 26", Guard Only
SEES-PTG-36-036	Guard, Platform/Toe/Apron for 36" opening, Actual 38" x 36"
SEES-PTG-36-038	Guard, Platform/Toe/Apron for 36" opening, Actual 38" x 38"
SEES-PTG-36-040	Guard, Platform/Toe/Apron for 36" opening, Actual 38" x 40"
SEES-PTG-36-042	Guard, Platform/Toe/Apron for 36" opening, Actual 38" x 42"
SEES-PTG-36-044	Guard, Platform/Toe/Apron for 36" opening, Actual 38" x 44"
SEES-PTG-36-046	Guard, Platform/Toe/Apron for 36" opening, Actual 38" x 46"
SEES-PTG-36-048	Guard, Platform/Toe/Apron for 36" opening, Actual 38" x 48"
SEES-PTG-42-021	Guard, Platform/Toe/Apron for 42" opening, Actual 44" x 21"
SEES-PTG-42-028	Guard, Platform/Toe/Apron for 42" opening, Actual 42" x 28", Guard Only
SEES-PTG-42-036	Guard, Platform/Toe/Apron for 42" opening, Actual 44" x 36"
SEES-PTG-42-038	Guard, Platform/Toe/Apron for 42" opening, Actual 44" x 38"
SEES-PTG-42-040	Guard, Platform/Toe/Apron for 42" opening, Actual 44" x 40"
SEES-PTG-42-042	Guard, Platform/Toe/Apron for 42" opening, Actual 44" x 42"
SEES-PTG-42-044	Guard, Platform/Toe/Apron for 42" opening, Actual 44" x 44"
SEES-PTG-42-046	Guard, Platform/Toe/Apron for 42" opening, Actual 44" x 46"
SEES-PTG-42-048	Guard, Platform/Toe/Apron for 42" opening, Actual 44" x 48"
SEES-PTG-48-036	Guard, Platform/Toe/Apron for 48" opening, Actual 50" x 36"
SEES-PTG-48-038	Guard, Platform/Toe/Apron for 48" opening, Actual 50" x 38"
SEES-PTG-48-040	Guard, Platform/Toe/Apron for 48" opening, Actual 50" x 40"
SEES-PTG-48-042	Guard, Platform/Toe/Apron for 48" opening, Actual 50" x 42"
SEES-PTG-48-044	Guard, Platform/Toe/Apron for 48" opening, Actual 50" x 44"
SEES-PTG-48-046	Guard, Platform/Toe/Apron for 48" opening, Actual 50" x 46"
SEES-PTG-48-048	Guard, Platform/Toe/Apron for 48" opening, Actual 50" x 48"
SEES-PTG-54-048	Guard, Platform/Toe/Apron for 54" opening, Actual 56" x 48"
SEES-PTG-STRUT	Strut, Arms and platform guard with hardware
SEES-RTG-036-48	Guard, Retractable Toe Guard, 36" W x 48" L Retracts 15"
SEES-RTG-042-48	Guard, Retractable Toe Guard, 42" W x 48" L Retracts 15"
SEES-RTG-046-48	Guard, Retractable Toe Guard, 46" W x 48" L Retracts 15"
SEES-RTG-048-48	Guard, Retractable Toe Guard, 48" W x 48" L Retracts 15"
SEES-RTG-050-48	Guard, Retractable Toe Guard, 50" W x 48" L Retracts 15"



SEES-PTG-42-042



SEES-PTG-STRUT

Door Wedge Tools

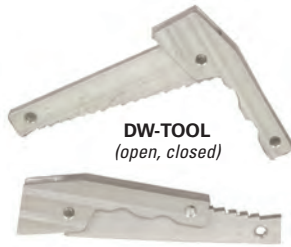

S.E.E.S. #	O.E.M. #	Description
DW-TOOL	10-850	Door Wedge Tool
MIS-DW-T1	SAF165/MT-114390-9	Door Wedge Tool, with Knob and fire tab slots
MIS-DW-T2	SAF164/MT-114390-8	Door Wedge Tool, with Knob standard without slot
MIS-DW-T3	10-851	Door Wedge Tool, with Knob, narrow door stop, 3/8" wide
SEES-DWT-001		SEES Door Wedge Tool, Blue Poly
SEES-DWT-002		SEES Door Wedge Tool, Black Poly
SEES-DWT-003		SEES Door Wedge Tool, Blue Poly with fire tab slot
SEES-DWT-004		SEES Door Wedge Tool, Black Poly with fire tab slot
SEES-DWT-004R		SEES Door Wedge Tool, Rubber 70 Duro with fire tab slot
SEES-DWT-005		SEES Spring Door Wedge Tool, Rubber Coated Spring Steel
SEES-DWT-006		SEES Door Wedge Tool, Stainless Steel Bottle Opener
DG-MT		Door Gap, Measuring tool
KOOL-KP5005		Sill Height Gauge, Metric, stainless steel



MIS-DW-T1



MIS-DW-T2



SEES-DWT-001



SEES-DWT-002



SEES-DWT-003



SEES-DWT-004



SEES-DWT-004R



SEES-DWT-005



SEES-DWT-006



DG-MT

Hatch Sills

S.E.E.S. #	O.E.M. #	Description
MIS-SILL-BRKT-001		Sill Mounting Bracket, with hardware



MIS-SILL-BRKT-001

S.E.E.S. #	O.E.M. #	Description
MIS-SILL-101	HS1S/8	Hatch Sill, Single Speed, Aluminum, 8ft
MIS-SILL-101A	HS1S/16	Hatch Sill, Single Speed, Aluminum, 16ft

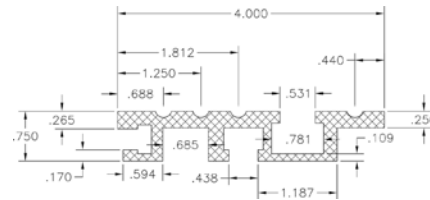

MIS-SILL-101

S.E.E.S. #	O.E.M. #	Description
MIS-SILL-102	HS2S/8	Hatch Sill, Two Speed, Aluminum, 8ft
MIS-SILL-102A	HS2S/16	Hatch Sill, Two Speed, Aluminum, 16ft

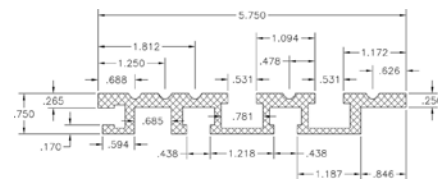

MIS-SILL-102

S.E.E.S. #	O.E.M. #	Description
MIS-SILL-SPECIAL		Sill, Single or Two Speed Cut to Size

Car Sills

S.E.E.S. #	O.E.M. #	Description
MIS-SILL-201	CS1S/8	Car Sill, Single Speed, Aluminum, 8ft
MIS-SILL-201A	CS1S/16	Car Sill, Single Speed, Aluminum, 16ft

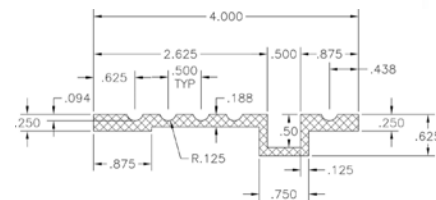

MIS-SILL-201

S.E.E.S. #	O.E.M. #	Description
MIS-SILL-202	CS2S/8	Car Sill, Two Speed, Aluminum, 8ft
MIS-SILL-202A	CS2S/16	Car Sill, Two Speed, Aluminum, 16ft

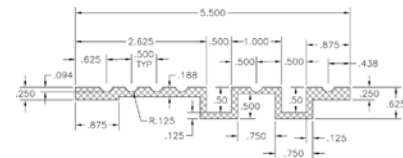

MIS-SILL-202

S.E.E.S. #	O.E.M. #	Description
MIS-SILL-210	CS1S/C	Car Sill, Single Speed, Center, Aluminum, 7ft

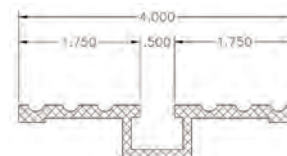

MIS-SILL-210

Tools for Sills

S.E.E.S. #	Description
MIS-TOOL-003	Step Drill Bits, high speed steel, 10 hole sizes range from minimum 13/16" to maximum 1-3/8". Shank size 7/16"
MIS-TOOL-202	Sill Height Gauge, Imperial Slider Ruler
MIS-TOOL-202M	Sill Height Gauge, Metric Slider Ruler
MIS-TOOL-203	Sill Height Gauge, Imperial, S/S Slider
MIS-TOOL-203M	Sill Height Gauge, Metric, S/S Slider

Pull Chain Door Locks

S.E.E.S. #	Description
MIS-189P-A	Courion pull chain door lock assembly, with keyless pipe



MIS-189P-A

Doors for Residential Elevators

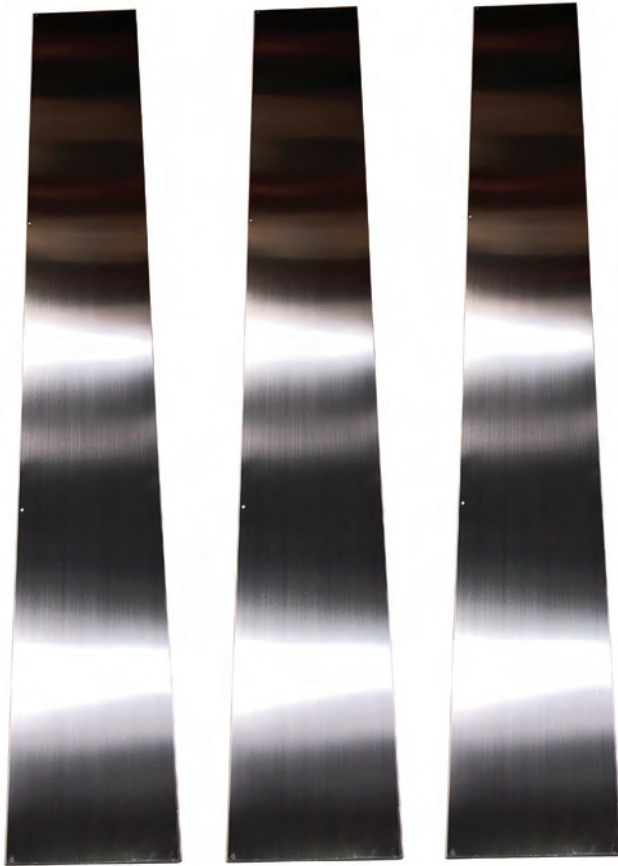

SEES-HL-LD-95X36-SS-001R

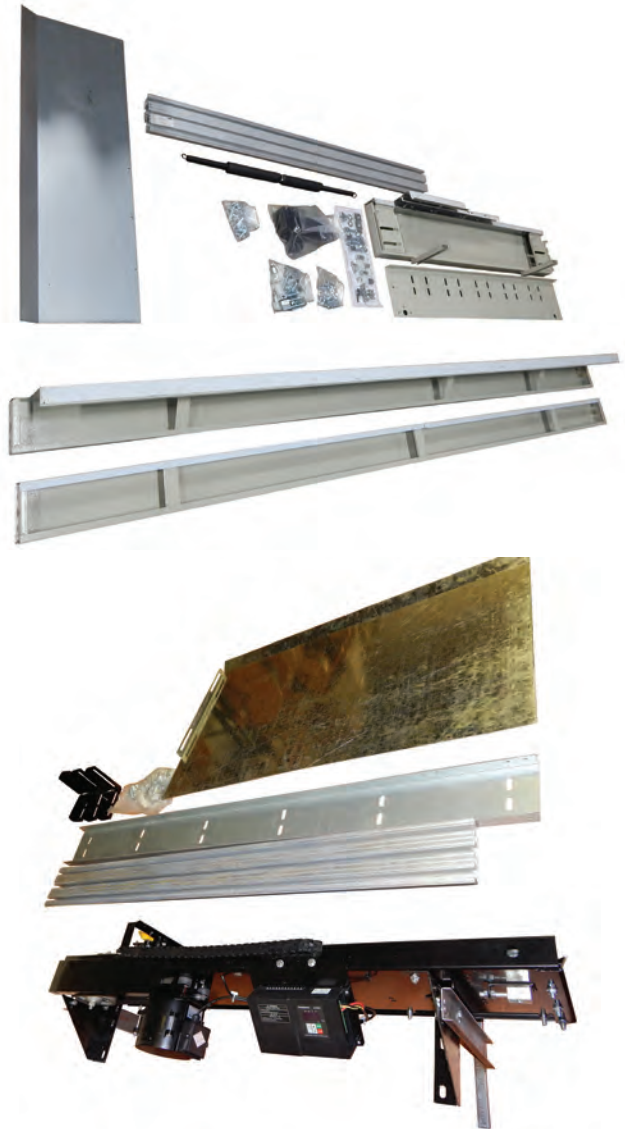

Doors for Residential Elevators

S.E.E.S. #	Description
SEES-HL-CD-83X36-GL-001R	Door Oper and Car Door, 3 Pane glass RH with 83" x 36" (2100mm x 900mm)
SEES-HL-CD-83X36-SS-001L	Door Oper and Car Door, 3 Pane SS LH with 83" x 36" (2100mm x 900mm)
SEES-HL-CD-83X36-SS-001R	Door Oper and Car Door, 3 Pane SS RH with 83" x 36" (2100mm x 900mm)
SEES-HL-CD-95X36-GL-001L	Door Oper and Car Door, 3 Pane glass LH with 95" x 36" (2400mm x 900mm)
SEES-HL-CD-95X36-GL-001R	Door Oper and Car Door, 3 Pane glass RH with 95" x 36" (2400mm x 900mm)
SEES-HL-CD-95X36-SS-001L	Door Oper and Car Door, 3 Pane SS LH with 95" x 36" (2400mm x 900mm)
SEES-HL-CD-95X36-SS-001R	Door Oper and Car Door, 3 Pane SS RH with 95" x 36" (2400mm x 900mm)
SEES-HL-CD-83X36-GL-001L	Door Oper and Car Door, 3 Pane glass LH with 83" x 36" (2100mm x 900mm)
SEES-HL-LD-83X36-GL-001L	Landing Door, 3 Panel glass LH with 83" x 36" (2100mm x 900mm)
SEES-HL-LD-83X36-GL-001R	Landing Door, 3 Panel glass RH with 83" x 36" (2100mm x 900mm)
SEES-HL-LD-83X36-SS-001L	Landing Door, 3 Panel SS LH with 83" x 36" (2100mm x 900mm)
SEES-HL-LD-83X36-SS-001R	Landing Door, 3 Panel SS RH with 83" x 36" (2100mm x 900mm)
SEES-HL-LD-95X36-GL-001L	Landing Door, 3 Panel glass LH with 95" x 36" (2400mm x 900mm)
SEES-HL-LD-95X36-GL-001R	Landing Door, 3 Panel glass RH with 95" x 36" (2400mm x 900mm)
SEES-HL-LD-95X36-SS-001L	Landing Door, 3 Panel SS LH with 95" x 36" (2400mm x 900mm)
SEES-HL-LD-95X36-SS-001R	Landing Door, 3 Panel SS RH with 95" x 36" (2400mm x 900mm)

Doors

Cab Door Features

- Doors are available in single-speed side slide, center-opening, two-speed side slide configurations
- Various door widths and heights are available to accommodate your project's needs
- Doors finish is stainless steel brushed (#4 finish) on 20 gauge material
- Doors are rated for 90 minutes fire resistance and UL Labeled accordingly



SEES-CAB-36-84-SS-R



SEES-CAB-42-84-CP



SEES-CAB-36-84-2SP-R

Cab Doors

S.E.E.S. #	Hand	Speed	Opening	Height	Hanger Mounting Hole Dimensions	Material/Finish
SEES-CAB-48-84-2S-L-S	Left	Double	24"	84"	4.125" Slow Door Only	Stainless Veneer
SEES-CAB-34-84-SS-R	Right	Single	34"	84"	4.125"	Stainless Veneer
SEES-CAB-36-84-SS-R	Right	Single	36"	84"	4.125"	Stainless Veneer
SEES-CAB-36-84-SS-L	Left	Single	36"	84"	4.125"	Stainless Veneer
SEES-CAB-36-84-2SP-R	Right	Two	36"	84"	4.125"	Stainless Veneer
SEES-CAB-36-84-2SP-L	Left	Two	36"	84"	4.125"	Stainless Veneer
SEES-CAB-36-84-CP-5WL	Left	Single	36"	84"	4.125"	5WL Stainless Steel
SEES-CAB-36-84-SS-L-M	Left	Single	36"	84"	4.125"	Muntz Veneer
SEES-CAB-36-84-SS-L-OTI-INTGRL	Left	Single	36"	84"	4.125" w/ Otis Integral Hangers	Stainless Veneer
SEES-CAB-36-84-SS-R-OTI-INTGRL	Right	Single	36"	84"	4.125" w/ Otis Integral Hangers	Stainless Veneer
SEES-CAB-36-84-SS-L-OTIS	Left	Single	36"	84"	4.125"	Stainless Veneer
SEES-CAB-36-84-SS-L-SPECIAL	Left	Single	36"	84"	4.125"	Stainless Veneer
SEES-CAB-36-84-SS-R-SPECIAL	Right	Single	36"	84"	4.125"	Stainless Veneer
SEES-CAB-36-84-SS-R-WIN	Right	Single	36"	84"	4.125" w/ Window - SPECIAL	Stainless Veneer
SEES-CAB-40-84-2SP-L-BB	Left	Two	40"	84"	4.125"	#4 Brushed Brass
SEES-CAB-40-84-CP	Center	Single	40"	84"	4.125"	Stainless Veneer
SEES-CAB-42-84-CP-5WL	Right	Single	40"	84"	4.125" w/ Window - SPECIAL	Stainless Veneer
SEES-CAB-42-84-CP	Center	Single	42"	84"	4.125"	Stainless Veneer
SEES-CAB-42-84-SS-R	Right	Single	42"	84"	4.125"	Stainless Veneer
SEES-CAB-42-84-SS-L	Left	Single	42"	84"	4.125"	Stainless Veneer
SEES-CAB-42-88.75-SS-L	Left	Single	42"	88.75"		Stainless Veneer
SEES-CAB-42-84-2SP-L	Left	Two	42"	84"	4.125"	Stainless Veneer
SEES-CAB-43.5-84.25-SS-R	Right	Single	42"	84.25"	Not Drilled	Stainless
SEES-CAB-43.5-84.25-SS-L	Right	Single	42"	84.25"	Not Drilled	Stainless
SEES-CAB-44-84-2SP-L	Left	Two	44"	84"	4.125"	Stainless Veneer
SEES-CAB-42-84-2SP-R	Right	Two	42"	84"	4.125"	Stainless Veneer
SEES-CAB-42-84-2SP-L	Left	Two	42"	84"	4.125"	Stainless Veneer
SEES-CAB-46-84-2SP-L	Left	Two	42"	84"	4.125"	Stainless Veneer
SEES-CAB-46-84-2SP-R	Right	Two	42"	84"	4.125"	Stainless Veneer

Cab Doors



SEES-CAB-34-84-SS-R



SEES-CAB-54-84-2S-CP



SEES-CAB-54-84-2S-RH

S.E.E.S. #	Hand	Speed	Opening	Height	Hanger Mounting Hole Dimensions	Material/Finish
SEES-CAB-42-84-CP-6940	Center	Single	42"	84"	4.125" GAL Hangers and Otis 6940 Locks	Stainless Veneer
SEES-CAB-42-84-CP-CA-M	Center	Single	42"	84"	4.125"	Stainless Veneer
SEES-CAB-42-84-CP-M	Center	Single	42"	84"	4.125"	Stainless Veneer
SEES-CAB-42-84-CP-MAC	Center	Single	42"	84"	4.125"	Stainless Veneer
SEES-CAB-42-84-CP-OTIS-6940	Center	Single	42"	84"	4.125"	Stainless Veneer
SEES-CAB-42-84-SS-L-OTIS	Left	Single	42"	84"	4.125"	Stainless Veneer
SEES-CAB-42-89.5-SS-R	Right	Single	42"	84"	4.125"	Stainless Veneer
SEES-CAB-43.5-83.25-SS-L-BLANK	Left	Single	43.5"	83.25"	Not Drilled	Stainless
SEES-CAB-44-84-SS-CP	Center	Single	44"	84"	4.125"	Stainless Veneer
SEES-CAB-44-84-SS-CP-A	Center	Single	44"	84"	4.125" Top Hole Only	Stainless Veneer
SEES-CAB-46-84-2S-CP	Center	Double	46"	84"	4.125"	Stainless Veneer
SEES-CAB-48-84-CP-SCH	Left		48"	84"	Drilled for Schindler	Stainless Veneer
SEES-CAB-48-84-2S-L	Left	Two	48"	84"	4.125"	Stainless Veneer
SEES-CAB-48-103-SS-CP-M	Center	Single	48"	103"	4.125"	Mirrored Stainless Steel
SEES-CAB-48-84-2S-R	Right	Two	48"	84"	4.125"	Stainless Veneer
SEES-CAB-48-84-2S-R-SPO-BLANK	Right	Two	48"	84"	Not Drilled, with Spec.	Dims
SEES-CAB-48-84-2S-L-BLANK	Left	Two	48"	84"	No Holes	Stainless Veneer
SEES-CAB-48-84-2S-CP	Center	Two	48"	84"	4.125"	Stainless Veneer
SEES-CAB-48-84-2S-R-6940	Right	Double	48"	84"	4.125" GAL Hangers and 6940 Lock	Stainless Veneer
SEES-CAB-48-84-2S-R-OTIS-6940	Right	Double	48"	84"	4.125" with Otis 6940 Lock	Stainless Veneer
SEES-CAB-48-84-SS-CP	Center	Single	48"	84"	4.125"	Stainless Veneer
SEES-CAB-48-96-2S-L	Left	Double	48"	96"	4.125"	Stainless Veneer
SEES-CAB-52-84-2S-LH	Left	Double	52"	84"	4.125"	Stainless Veneer
SEES-CAB-52-84-2S-RH	Right	Double	52"	84"	4.125"	Stainless Veneer
SEES-CAB-54-84-2S-CP	Center	Double	54"	84"	4.125"	Stainless Veneer
SEES-CAB-54-84-2S-LH	Left	Double	54"	84"	4.125"	Stainless Veneer
SEES-CAB-54-84-2S-RH	Right	Double	54"	84"	4.125"	Stainless Veneer
SEES-CAB-54-90-SS-CP	Center	Single	54"	90"	4.125"	Stainless Veneer
SEES-CAB-54-84-2S-RH	Right	Two	54"	84"	4.125"	Stainless Veneer
SEES-CAB-54-84-2S-CP	Center	Two	54"	84"	4.125"	Stainless Veneer
SEES-CAB-54-84-2S-LH	Left	Two	54"	84"	4.125"	Stainless Veneer
SEES-CAB-CP-SPECIAL	Center	Per Spec				

Door Features

- Doors are available in single-speed side slide, center-opening, two-speed side slide configurations
- Various door widths and heights are available to accommodate your project's needs
- Doors finish is stainless steel brushed (#4 finish) on 20 gauge material
- Doors are rated for 90 minutes fire resistance and UL Labeled accordingly

Hall / Entrance

S.E.E.S. #	Hand	Speed	Opening	Height	Hanger Mounting Hole Dimensions	Material/Finish
SEES-ENT-36-84-CP	Center	Single	36"	84"	4.125"	Stainless Veneer
SEES-ENT-36-84-SS-R-OTI-INTGRL	Right	Single	36"	84"	4.125", w/ Otis Integral Hangers	Stainless Veneer
SEES-ENT-36-84-SS-L-OTI-INTGRL	Left	Single	36"	84"	4.125", w/ Otis Integral Hangers	Stainless Veneer
SEES-ENT-36-84-SS-L	Left	Single	36"	84"	4.125"	Stainless Veneer
SEES-ENT-36-84-SS-R	Right	Single	36"	84"	4.125"	Stainless Veneer
SEES-ENT-36-84-SS-L-CA	Left	Single	36"	84"	4.125" H w/o Escutcheon Holes	Stainless Veneer
SEES-ENT-36-84-SS-R-CA	Right	Single	36"	84"	4.125" H w/o Escutcheon Holes	Stainless Veneer
SEES-ENT-36-84-SS-L-THY	Left	Single	36"	84"	4.125"	Stainless Veneer
SEES-ENT-36-84-SS-L-TKE	Left	Single	36"	84"	4.125" Drilled for TKE	Stainless Veneer
SEES-ENT-36-84-SS-L-WHITE	Left	Single	36"	84"	4.125"	Painted White
SEES-ENT-36-84-2SP-L	Left	Two	36"	84"	4.125"	Stainless Veneer
SEES-ENT-36-84-2SP-R	Right	Two	36"	84"	4.125"	Stainless Veneer
SEES-ENT-36-84-2SP-L-BLACK	Left	Double	36"	84"	4.125"	Painted black
SEES-ENT-36-84-2SP-R-BLACK	Right	Double	36"	84"	4.125"	Painted black
SEES-HALL-40-84-2SP-L-BB	Left	Two	40"	84"	4.125"	#4 Brushed Brass
SEES-ENT-40.25-84-2SP-R	Right	Two	40.25"	84"	4.125"	Stainless Veneer
SEES-ENT-42-84-CP	Center	Single	42"	84"	4.125"	Stainless Veneer
SEES-ENT-42-84-CP-CA	Center	Single	42"	84"	4.125" H w/o Escutcheon Holes	Stainless Veneer
SEES-ENT-42-84-CP-CA-M	Center	Single	42"	84"	4.125" w/o Escutcheon Hole	Stainless Veneer
SEES-ENT-42-84-CP-OTIS-6940	Center	Single	42"	84"	4.125" Otis 6940 Locks and Hangers	Stainless Veneer
SEES-ENT-42-84-CP-6940	Center	Single	42"	84"	4.125" GAL Hangers and Otis 6940 Locks	Stainless Veneer
SEES-ENT-42-84-SS-L	Left	Single	42"	84"	4.125"	Stainless Veneer
SEES-ENT-42-84-SS-L-DVR	Left	Single	42"	84"	4.125"	#4 Stainless Steel
SEES-ENT-42-84-SS-L-THY	Left	Single	42"	84"	4.125" Drilled for TKE	Primed for Paint
SEES-ENT-42-84-SS-L-TKE	Left	Single	42"	84"	4.125" Drilled for TKE	Stainless Veneer
SEES-ENT-42-84-SS-R	Right	Single	42"	84"	4.125"	Stainless Veneer
SEES-ENT-42-84-SS-L-P4P	Left	Single	42"	84"	4.125"	Primed for Paint
SEES-ENT-42-84-SS-R-P4P	Right	Single	42"	84"	4.125"	Primed for Paint
SEES-ENT-42-84-SS-L-316	Left	Single	42"	84"	4.125" Galv. Core	#4 Brushed Brass
SEES-ENT-42-84-SS-R-316	Right	Single	42"	84"	4.125"	Stainless Veneer
SEES-ENT-42-84-SS-R-BLANK	Right	Single	42"	84"	No holes	Stainless Veneer
SEES-ENT-42-84-2SP-L	Left	Two	42"	84"	4.125"	Stainless Veneer
SEES-ENT-42-84-2SP-L-BLANK	Left	Two	42"	84"	No Holes	Stainless Veneer
SEES-ENT-42-84-2SP-R	Right	Two	42"	84"	4.125"	Stainless Veneer
SEES-ENT-42-107-CP	Center	Single	42"	107"	4.125", GAL, Left oriented	Stainless Veneer
SEES-ENT-OTIS-84-SS-RH	Right	Single	43-3/8"	84-1/2"	4.125"	Stainless Veneer

Hall / Entrance

S.E.E.S. #	Hand	Speed	Opening Height		Hanger Mounting Hole Dimensions	Material/Finish
SEES-ENT-48-84-SS-CP-DVR-INTGR	Center	Single	48"	84"	Dover Intgrl Hangers	Stainless Veneer
SEES-ENT-48-84-2S-CP	Center	Double	48"	84"	4.125"	Stainless Veneer
SEES-ENT-48-84-2S-CP-CA	Center	Double	48"	84"	4.125" w/o Escutcheon Holes	Stainless Veneer
SEES-ENT-46-84-2S-CP-P4P	Center	Double	46"	84"	4.125"	Primed for Paint
SEES-ENT-46-84-2S-L-P4P	Left	Double	46"	84"	4.125"	Primed for Paint
SEES-ENT-46-84-2S-R-P4P	Right	Double	46"	84"	4.125"	Primed for Paint
SEES-ENT-46-84-2SP-L	Left	Two	46"	84"	4.125"	Stainless Veneer
SEES-ENT-48-84-2S-R	Right	Double	48"	84"	4.125"	Stainless Veneer
SEES-ENT-48-84-2S-R-6940	Right	Double	48"	84"	4.125" GAL Hangers and Otis 6940 Locks	Stainless Veneer
SEES-ENT-48-84-2S-R-OTIS-6940	Right	Double	48"	84"	4.125" Otis 6940 Lock	Stainless Veneer
SEES-ENT-46-84-2SP-R	Right	Two	46"	84"	4.125"	Stainless Veneer
SEES-ENT-48-84-2SP-L	Left	Two	48"	84"	4.125"	Stainless Veneer
SEES-ENT-48-84-2SP-L-CA	Left	Single	48"	84"	4.125" H w/o Escutcheon Holes	Stainless Veneer
SEES-ENT-48-84-2SP-L-PACKAGE	Left	Double	48"	84"	4.125" Per Specs and Drawing	Stainless Veneer
SEES-ENT-48-84-2SP-L-THY	Left	Double	48"	84"	4.125" Thyssen Drilling	Stainless Veneer
SEES-ENT-48-84-2SP-R-THY	Right	Double	48"	84"	4.125" Thyssen Drilling	Stainless Veneer
SEES-ENT-48-84-2SP-RH-MAYO-OTI	Right	Two	48"	84"	Drilled for Otis	Stainless Steel
SEES-ENT-48-84-2SP-R-CA	Right	Single	48"	84"	4.125" H w/o Escutcheon Holes	Stainless Veneer
SEES-ENT-48-96-2S-L	Left	Double	48"	96"	4.125"	Stainless Veneer
SEES-JAMB-48-96-2SP-RH	Right	Two	48"	96"	No Holes	Stainless Veneer
SEES-ENT-52-84-2S-LH	Left	Double	52"	84"	4.125"	Stainless Veneer
SEES-ENT-52-84-2S-RH	Right	Double	52"	84"	4.125"	Stainless Veneer
SEES-ENT-54-84-2S-CP	Center	Two	54"	84"	4.125"	Stainless Veneer
SEES-ENT-54-84-2S-LH	Left	Two	54"	84"	4.125"	Stainless Veneer
SEES-ENT-54-84-2S-RH	Right	Two	54"	84"	4.125"	Stainless Veneer

Doors For California Only

S.E.E.S. #	Hand	Speed	Opening Height		Hanger Mounting Hole Dimensions	Material/Finish
SEES-ENT-42-84-2SP-R-CA	Right	Two	42"	84"	W/o Escutcheon Holes	Stainless Veneer
SEES-ENT-42-84-SS-R-CA	Right	Single	42"	84"	W/o Escutcheon Holes	Stainless Veneer
SEES-ENT-42-84-SS-L-CA	Left	Single	42"	84"	W/o Escutcheon Holes	Stainless Veneer
SEES-ENT-43.5-83.25-SS-L-CA-BL	Left	Single	43.5"	83.25"	Not Drilled, w/o Escutcheon Holes	Stainless Steel
SEES-ENT-43.5-83.25-SS-R-CA-BL	Right	Single	43.5"	83.25"	Not Drilled, w/o Escutcheon Holes	Stainless Steel
SEES-ENT-48-84-2SP-L-CA-BLANK	Left	Two	48"	84"	No Holes, w/o Escutcheon Holes	Stainless Veneer

Sight Guards

S.E.E.S. #	Description
SEES-ENT-52-84-2S-RH	Sight Guards , for SEES-ENT-48-84-2SP-L
SEES-ENT-SG-84-001	Sight Guards , for SEES-ENT-SG-84-001
SEES-ENT-SG-84-001	Sight Guards , Special Size

SEES GUARDIAN

HEAVY DUTY DOORS



**SEES
GUARDIAN**



BUY ONE DOOR

GET

**25%
OFF**

A DOOR KIT

HEAVY DUTY PROTECTION

- Protect passengers
- Enhance safety
- Save time and money
- Reduce call backs
- Made in U.S.A.
- Easy to install
- Bundled value

FEATURES

- UL Rated
- Stainless Steel (304 #4) Finish
- 14 Gauge on Back
- 16 Gauge on Front
- 14GA Reinforcing Ribs (4 to 6)
- Covers on Front and Back
- Fire-Rated to 90 Minutes

Hall Door Kit:

- 2 Enforcers
- 1 SmarTork Spirator
- 1 SmarTork Bracket
- 2 Restrictor Flags
- 1 Door Wedge Tool



Car Door Kit:

- 2 Enforcers
- 1 Restrictor Cam
- 1 Door Wedge Tool



**THE SEES
RESTRICTOR**

The Enforcer

SMARTORK™

FORTIFIED DOORS FOR HEAVY DUTY SECURITY



@SEESinc



SEESinc.com/blogs



SEESinc

Always Smooth Sailing



SOUTHERN ELEVATOR
& ELECTRIC SUPPLY

Freight Straps

S.E.E.S. #	Description
MIS-105	Pull Strap, 30", for freight elevators
MIS-106	Pull Strap, 18", for freight elevators
MIS-107	Pull Strap, 24", for freight elevators
MIS-107A	Pull Strap, 36", for freight elevators
MIS-107B	Pull Strap, 48", for freight elevators
MIS-107C	Pull Strap, 60", for freight elevators
MIS-107D	Pull Strap, 72", for freight elevators
MIS-107F	Pull Strap, 96", for freight elevators



MIS-106

■ Extra durable with heavy duty rivets for mounting. Need a length other than what's listed? We'll custom make to your requirements.



MIS-107



MIS-107D

Galvanized Aircraft Cable

S.E.E.S. #	Description
MIS-300	Aircraft Cable, 1/8" Galvanized steel cable cut to your specified length. Can be used as a selector cable
MIS-300-PVC	Aircraft Cable, 1/8" Galvanized steel cable as above, but PVC coated to 3/16"
MIS-300A	Aircraft Cable, 3/32" Galvanized steel cable cut to your specified length
MIS-300B	Aircraft Cable, 1/16" Galvanized steel cable cut to your specified length
MIS-300C	Aircraft Cable, 1/16" Steel, 3/32" O.D. PVC
MIS-300D	Aircraft Cable, 3/64" Galvanized, 7 x 7 Stranding



MIS-300

Spirators

Spirators & Spacers

S.E.E.S. #	Description
MIS-124	Spirator, 5" O.D., reel closer with combo hub
MIS-124-20PAC	Spirator, 5" O.D., economic pack of 20
MIS-124A	Mounting stud, 1-3/4" with threaded shaft for spirator
MIS-124B	Cable stud, 1-1/4" for spirator cable hitch
MIS-124C	Cable stud, 1-3/8" for spirator cable hitch
MIS-124E	Spirator, 5" O.D., Heavy Duty reel closer with combo hub
MIS-124E-KIT	Spirator Kit, 5" OD Heavy Duty Combo Hub with Spacers
MIS-124E-20PAC	Spirator, 5" O.D., Heavy Duty, economic pack of 20
MIS-124F	Spirator, Spirator, 4.125 D, 1.063 W
MIS-124G	Spirator, 5" O.D., with combo hub
MIS-124K USP22297	Closer, Reel Heavy Duty with Bracket
MIS-124S	Spirator Spacer Kit
MIS-124-KIT	Spirator Kit, Spirator, 5" O.D. with spacer kit
MIS-124-ST	Reel Closer, 6" SmarTork door closer up to 20% more tension
MIS-124-ST-BK	Bracket, for SmarTork door closer
MIS-124-ABK	Spirator Bracket with spacer for square shank
MIS-160	Bracket with square shank for MIS-124 Spirator
GDO-7	Bracket, 3-1/2" x 2-1/2", for MIS-124
WDO-34	Spirator, closing reel with cable, 6" diameter, Heavy Duty

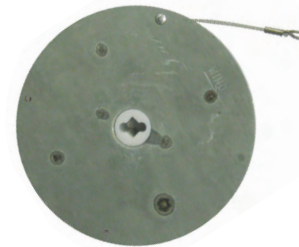

MIS-124



MIS-124A



MIS-124B



MIS-124C



MIS-124E



MIS-124G



MIS-124S



MIS-124-ST



MIS-124-ST-BK



MIS-124-ABK



WDO-34



MIS-160

Door Keys

Manufactured to strict quality standards to meet or exceed OEM specifications. Highest quality materials are machined and plated to resist corrosion to ensure long lasting performance. *Ask about our quantity discounts.*

S.E.E.S. #	O.E.M. #	Description
MIS-119	INT1-0034N	Flapper Key with collar, for Montgomery, Dover, Haughton, Otis and GAL
MIS-119-P		Door Key , Flapper w/ Plastic Handle and flexible safety shaft
MIS-119T		Door Key , Emergency Door Key, 8" L with Flapper, universal
MIS-120		Access Key , 5/8" diameter x 3-1/4" L, 1/2" I.D.
MIS-121		Car Panel Key , 7/16" diameter x 4" L, 21/64" I.D.
MIS-121A	INT5-0030N	G.A.L. Key , door key Type M for swing doors
MIS-122		Door Key , 3-in-1 Type M GAL, Flapper
MIS-123		Door Key , 5-in-1 Type M GAL, Flapper, and Jumpers
MIS-KEYPAK		Keypack , value door key pack of 11 keys ODO-45, ODO-46, ODO-46A, ODO-46B, WDO-57, WDO-58, MIS-119, MIS-120, MIS-121, MIS-121A, HDO-1
SEES-KCDK-001		SEES Keychain Door Key , "GAL" Flapper Flexible Shaft with Key Ring
SEES-MULTI-KEY-001-SPS		Multi Key Tool , Side Plate Special Engrave
SEES-MULTI-KEY-001B		Multi Key Tool , T-Key, Single Drop & Lunar Blue Handle
SEES-MULTI-KEY-001B-SP		Multi Key Tool , T-Key, Single Drop & Lunar, Blue Handle, Special Engraving
SEES-MULTI-KEY-001BLK		Multi Key Tool , T-Key, Single Drop & Lunar Black Handle
SEES-MULTI-KEY-001BLK-SP		Multi Key Tool , T-Key, Single Drop & Lunar, Black Handle, Special Engraving
SEES-MULTI-KEY-001R		Multi Key Tool , T-Key, Single Drop & Lunar Red Handle
SEES-MULTI-KEY-002B-FZ1		Multi Key Tool , FEO, FL Zone 1 Key, Single Drop & Lunar, Blue Handle
SEES-MULTI-KEY-002B-FZ2		Multi Key Tool , FEO, FL Zone 2 Key, Single Drop & Lunar, Blue Handle
SEES-MULTI-KEY-002B-FZ3		Multi Key Tool , FEO, FL Zone 3 Key, Single Drop & Lunar, Blue Handle
SEES-MULTI-KEY-002B-FZ4		Multi Key Tool , FEO, FL Zone 4 Key, Single Drop & Lunar, Blue Handle
SEES-MULTI-KEY-002B-FZ5		Multi Key Tool , FEO, FL Zone 5 Key, Single Drop & Lunar, Blue Handle
SEES-MULTI-KEY-002B-FZ6		Multi Key Tool , FEO, FL Zone 6 Key, Single Drop & Lunar, Blue Handle
SEES-MULTI-KEY-002B-FZ7		Multi Key Tool , FEO, FL Zone 7 Key, Single Drop & Lunar, Blue Handle
SEES-MULTI-KEY-002R-FZ-SP		Multi Key Tool , FEO, FL Zone Key (Specify), Single Drop & Lunar, Red Handle, Special Markings
SEES-MULTI-KEY-003B		Multi Key Tool , T-Key, Single Drop & Lunar, Blue Handle, Door Lock Pick
SEES-MULTI-KEY-004B		Multi Key Tool , Single Drop & Lunar, Blue Handle, Allen Key Set
SEES-MULTI-KEY-005B		Multi Key Tool , Double Drop & Lunar, Blue Handle, T-Key Set
WDO-58E	W-824T-E	T-Key , Extended 15" OAL



MIS-119



MIS-119-P



MIS-120



MIS-121



MIS-121A



MIS-122



SEES-MULTI-KEY-001B



SEES-MULTI-KEY-001BLK



SEES-MULTI-KEY-002B-FZ7

Otis Keys

S.E.E.S. #	O.E.M. #	Description
ODO-45	194AD2	Lunar Key, 10-1/2" Emergency Hoistway
ODO-46	194AD7	Door Key, Double Drop
ODO-46A	194AD3	Door Key, Single drop
ODO-46-P	AAA194AZ1	Door Key, Double Drop, with Plastic Handle and flexible safety shaft
ODO-46A-P	AAA194AZ6	Door Key, Triple Drop, with Plastic Handle and flexible safety shaft
ODO-46B	194AD6	Close Couple Key
ODO-46C		Door Key, For GEN II Key Plastic Safety Handle
ODO-46D		Door Access Device for Gen II, Stainless Steel Escutcheon Tube and Hardware

Westinghouse Keys

S.E.E.S. #	O.E.M. #	Description
WDO-57	569A884H01	Lunar key, 6" L
WDO-58	W-824T	T-Key, 9" L
WDO-58E	W-824T-E	T-Key, Extended 15" OAL



ODO-45



ODO-46A

ODO-46

ODO-46B



ODO-46-P



ODO-46A-P



WDO-57



WDO-58



CUSTOMIZABLE MULTI-KEY!

PART#: SEES-MULTI-KEY-001B



OTHER KEYS AVAILABLE FOR CUSTOMIZATION:

MIS-121

MIS-121A

MIS-122

ODO-46



Always Smooth Sailing

2781 West McNab Rd, Pompano Beach, FL 33069 • (800) 526-0026 • www.SEESinc.com

Escutcheons

Hole plugs

S.E.E.S. #	O.E.M. #	Description
MIS-144C	7603	Plug, 1/2" Escutcheon chrome hole
MIS-144D	7604	Plug, 5/8" Escutcheon chrome hole
MIS-144E		Hole Plug, 3/4" Chrome Plated for Escutcheon
MIS-144F		Hole Plug, 1" Chrome Plated for Escutcheon
MIS-144G		Hole Plug, 1-1/4" Chrome Plated for Escutcheon
MIS-144H		Hole Plug, 1-3/8" Chrome Plated for Escutcheon
MIS-144M		Hole Plug, SS #4 Brush, Fits 1/4" hole up to 1-1/2" O.D.
MIS-144N		Hole Plug, Brass for 1/2" I.D. 1-3/4" L
MIS-144P		Hole Plug, Aluminum for 1/2" I.D. x 2" L
MIS-144R		Hole Plug, for 1/2" I.D. Hole x 1-3/4" L, 304SS #4 Brush
MIS-144Q		Hole Plug, for 5/8" I.D. Hole x 1.815" L, 304SS #4 Brush
MIS-210		Collar, Rubber Protective Key Collar, 2" diameter x 1/2" x 3/8" I.D.



MIS-144C



MIS-144E



MIS-144F



MIS-144G



MIS-144P



MIS-144Q

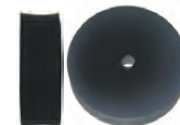

MIS-210

Escutcheons

S.E.E.S. #	O.E.M. #	Description
MIS-144		Escutcheon, Hall door key hole, 1-3/4" L for 3/8" diameter keys, 27/64" I.D., 15/16" O.D., 1-1/4" length threaded
MIS-144B		Escutcheon, Hall door key hole, 1-3/8" L, 7/16" I.D., 3/4" O.D.
MIS-144I		Escutcheon, door sleeve, brass, 1.5" L x .625" O.D. x .875" lip
MIS-144J		Escutcheon, Door Key Hole, Threaded, 1.5" L x .0625" dia., Lip=0.875", Aluminum
MIS-144K		Escutcheon, Door Key Hole, Threaded, 2.0" L x .0625" dia., Lip=0.875", Brass
MIS-144L		Escutcheon, Door Key Hole, Threaded, 2.0" L x .0625" dia., Lip=0.875", Aluminum
MIS-189V		Plug Lock, door Escutcheon with SEES #5 Key



MIS-144



MIS-144B



Westinghouse Escutcheons

S.E.E.S. #	O.E.M. #	Description
WDO-57A		Escutcheon, for lunar key, self-adhesive
WDO-57B		Escutcheon plate, for "T" key, 7/8" face, stainless steel finish



WDO-57A



WDO-57B



ODO-73



ODO-73A



ODO-73B

Otis Escutcheons

S.E.E.S. #	O.E.M. #	Description
ODO-73	321CVI	Escutcheon, Door Key Hole, 2.75" L x 0.5" dia., Lip=0.625" dia, Stainless Steel
ODO-73A	321CV5	Escutcheon, Door Key Hole, 2.75" L x 0.5" diameter, Lip=0.625" diameter, Brass
ODO-73B	386TZI-3	Escutcheon, for lunar key
ODO-73D		Escutcheon, Door Key Hole, 2.75" L x 0.5" diameter, Lip=0.625" dia, Aluminum
ODO-73E		Escutcheon, Door Key Hole, 2.0" L x 0.5" dia, Lip=0.625" dia, Stainless Steel
ODO-73F		Escutcheon, Door Key Hole, 2.0" L x 0.5" diameter, Lip=0.625" dia, Brass
ODO-73G		Escutcheon, Door Key Hole, 2.0" L x 0.5" diameter, Lip=0.625" dia, Aluminum
ODO-73H		Escutcheon, Door Key Hole, 1.5" L x 0.5" dia., Lip=0.625" dia, Stainless Steel
ODO-73I		Escutcheon, Door Key Hole, 1.5" L x 0.5" diameter, Lip=0.625" dia, Brass
ODO-73J		Escutcheon, Door Key Hole, 1.5" L x 0.5" diameter, Lip=0.625" dia, Aluminum
ODO-73K		Escutcheon, Door Sleeve, SS 1.75" L x .50" diameter x .625" Lip
ODO-73L		Escutcheon, Door Sleeve, Brass 1.75" L x .50" diameter x .625" Lip
ODO-73M		Escutcheon, Door Sleeve, Alum 1.75" L x .50" diameter x .625" Lip
ODO-73R		Escutcheon, Door Sleeve, Brass 3.25" L x .50" diameter x .625" Lip
ODO-73-SP-NUT		Escutcheon Speed Nut, 1/2" for ODO-73 series
ODO-73U		Escutcheon, Door Sleeve, Alum 4.0" L x .50" diameter x .625" Lip

Belts

Hi-Power® V-Belts

Offering excellent performance and superior strength. Patented construction features Flex Weave Cover and flex bonded tension cords. Belts are oil and heat resistant for reliability.

S.E.E.S. #	O.E.M. #	Outer Circumf.
MIS-BLT1	3VX250	25.0"
MIS-BLT2	3VX265	26.5"
MIS-BLT3	3VX280	28.0"
MIS-BLT4	3VX300	30.0"
MIS-BLT5	3VX315	31.5"
MIS-BLT6	3VX335	33.5"
MIS-BLT7	3VX355	35.5"
MIS-BLT8	3VX375	37.5"
MIS-BLT9	3VX400	40.0"
MIS-BLT10	3VX425	42.5"
MIS-BLT11	3VX450	45.0"
MIS-BLT12	3VX475	47.5"
MIS-BLT13	3VX500	50.0"
MIS-BLT14	3VX530	53.0"



MIS-BLT1 thru MIS-BLT22



MIS-BLT25

S.E.E.S. #	O.E.M. #	Outer Circumf.
MIS-BLT15	3VX560	56.0"
MIS-BLT16	3VX600	60.0"
MIS-BLT17	3VX630	63.0"
MIS-BLT17A	3V630	63.0"
MIS-BLT18	3VX670	67.0"
MIS-BLT19	3VX710	71.0"
MIS-BLT20	3VX750	75.0"
MIS-BLT21	3V800	80.0"
MIS-BLT22	3V950	95.0"
MIS-BLT25	B51	54.0"
MIS-BLT26	B53	56.0"
MIS-BLT23	B58	61.0"
MIS-BLT24	B71	73.0"
MIS-BLT24A	B70 5L730	73.0"
MIS-BLT27	5VX600	60"
MIS-BLT28	5V710	71"
MIS-BLT29	3VX560	56"
MIS-BLT32	AX31	33"
MIS-BLT33	5V750	75"

S.E.E.S. #	Description
MIS-BLT-PFT-001	Belt, Timing P5M-10 Sold Per Foot
MIS-BLT-PFT-002	Belt, Timing 8M-10 Sold Per Foot
MIS-BLT-PFT-003	Belt, Timing HTD5M-10 Sold Per Foot
MIS-BLT-PFT-004	Belt, Timing 8M-8 Sold Per Foot
MIS-BLT-PFT-005	Belt Neoprene, Drive, ESA (L8M12) Sold Per Foot
MIS-BLT-REEL-001	Belt, Timing P5M-10 200 Meter Reel (656 Feet)
MIS-BLT-REEL-002	Belt, Timing 8M-10 150 Meter Reel (492 Feet)
MIS-BLT-REEL-003	Belt, Timing HTD5M-10 150 Meter (492 Feet)
MIS-BLT-REEL-005	Belt Neoprene, Drive ESA (L8M12) 150 M = 492 FT.

■ For additional belts see pgs 560, 615, 650, 679, 790, 803, 891



Safety Edge

SEES Light Curtain

S.E.E.S. #	Description
SEES-SCREEN-001B	SEES Screen II, Light Curtain, blue/red combo, 120 VAC
SEES-SCREEN-001G	SEES Screen II, Light Curtain, green/red combo, 120 VAC
SEES-SCREEN-001N	SEES Screen II, Light Curtain, Door Edge with Nudging
SEES-SCREEN-001NC	SEES Screen II, Nudging, Power Supply Only
SEES-SCREEN-001C	SEES Screen II, 120 VAC Controller Only
SEES-SCREEN-001R	SEES Screen II, Receiver Only
SEES-SCREEN-001T	SEES Screen II, Transmitter Only
SEES-SCREEN-002N	SEES Screen II, Light Curtain Waterproof, with Nudging
SEES-SCREEN-HL-001A	SEES Screen II, 2 FT Light Curtain with 110 VAC
SEES-SCREEN-HL-002A	SEES Screen II, 5 FT Light Curtain with 110 VAC
SEES-SCREEN-HL-003A	SEES Screen II, 4 FT Light Curtain with 110 VAC
SEES-SCREEN-004	SEES Screen II, Light Curtain Standard, 24 VDC
SEES-SCREEN-004C	SEES Screen II, 24 VDC Controller only
SEES-SCREEN-005	SEES Screen II, Cable set Replacement cables
SEES-SCREEN-006	SEES Screen II, Light Curtain Standard, 220 VAC
SEES-SCREEN-006C	SEES Screen II, 220 VAC Controller Only
SEES-SCREEN-007	Replacement Connectors, 300V 10A
SEES-SCREEN-008	SEES Screen II, Light Curtain Slimline with 24 VDC Controller
SEES-SCREEN-009	SEES Screen II, Light Curtain MOVFR Direct Connect No Power Supply required for GAL MOVFR
SEES-SCREEN-HL-001	SEES Screen II, 2 FT Light Curtain Assembly with 24 VDC PS
SEES-SCREEN-HL-002	SEES Screen II, 5 FT Light Curtain Assembly with 24 VDC PS
SEES-SCREEN-HL-003	SEES Screen II, 4 FT Light Curtain Assembly with 24 VDC PS



CSA Approved

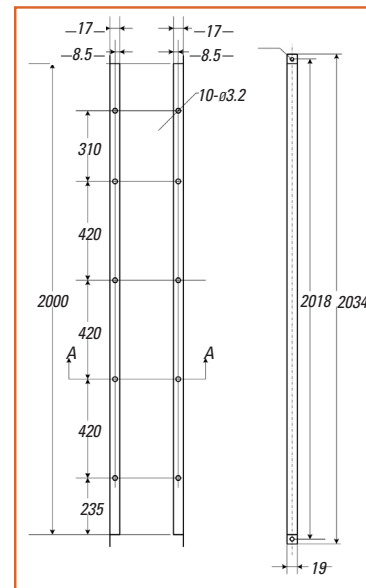

Plug Close Up

SEES-SCREEN-001N



Power Supply



Hardware

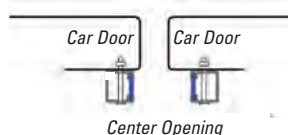
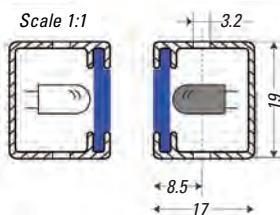

Center Opening

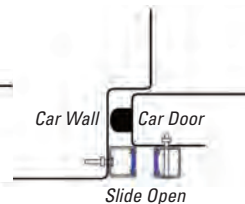

Slide Open



SEES-SCREEN-001C



SEES-SCREEN-005



MIS-176

Electric Eye Assemblies

S.E.E.S. #	O.E.M. #	Description
MIS-176	0000182000	Reflector, electric eye, 2.75" x 1.25" with self adhesive
MIS-176A		Reflective tape, 2" W, specify length
MIS-176B		Reflective tape, 3" W, specify length
MIS-180	1004-H Duo-Path	Electric Eye, Dual Beam Photo eye assembly, includes power cable and adjustable mounting brackets



MIS-180

Safety Edge



MIS-SE-2

MIS-SE-2

- 64 Redundant IR LED's
- Dual voltage power supply 120/240 VAC
- Nudge/buzzer "ON" delay timer is adjustable from 5 to 45 sec. Buzzer can be easily disabled with selector switch.
- Totally immune to ANY ambient light, including strobes and fluorescent.
- Optional "Waterproof" models are available. Fully functional from -25° to $+158^{\circ}$ F (-4° C to 70° C).
- All models can be installed in either Center or Side parting doors.
- Automatic Dynamic Sensitivity Adjustment (DSA) compensates for severe misalignment, condensation & damaged or dirty lens; also provides on-the-fly dynamic adjustments of sensitivity as doors open or close.
- Energy management system improves reliability by automatically reducing power to LED's by 75% and to the power supply by 50% when elevator doors are closed.

Universal Safety Edge Replacement

S.E.E.S. #	O.E.M. #	Description
MIS-SE-1A		Safety Door Edge, E40/32 with Model 280 Power Supply
MIS-SE-2		Universal Safety Edge
MIS-SE-2A		Power Supply Board
MIS-SE-2B		P.C. Board, with nudging
MIS-SE-2C		Power Supply, in non-metallic housing
MIS-SE-2D		Cable, replacement for Light Beam
MIS-SE-2E		Cable, replacement for Receiver Beam
MIS-SE-2N		Universal Safety Edge, with nudging
MIS-SE-2-INT1	ECI-1	Interface Cable, ECI-1 for Magic Edge Power Supply
MIS-SE-2-INT3	ECI-3	Interface Cable, ECI-3 for GAL MOVFR Operator
MIS-SE-2-INT4	ECI-4	Interface Cable, ECI-4 for N.C.
MIS-SE-2-INT5	ECI-5	Interface Cable, ECI-5 for N.O.
MIS-SE-3		Universal Safety Edge, waterproof
MIS-SE-3N		Universal Safety Edge, waterproof with nudging
MIS-SE-4		Remote Control, door screen edge system
MIS-SE-4R		Remote Control, for MIS-SE-4 system



MIS-SE-2A



MIS-SE-2C



MIS-SE-2N



MIS-SE-2-INT1



MIS-SE-2-INT3



MIS-SE-3



MIS-SE-4



MIS-SE-4R

Safety Edge

S.E.E.S. #	Description
MIS-SE-5L	SEEScreen left hand combo standard Tx with slim-line Rx
MIS-SE-5L-GAL	SEEScreen LH combo for GAL MOVFR, standard Tx with slim-line Rx
MIS-SE-5M	SEEScreen mounting kit for R.H. & L.H. combo
MIS-SE-5R	SEEScreen right hand combo standard Rx with slim-line Tx
MIS-SE-5R-GAL	SEEScreen RH combo for GAL MOVFR standard Rx with slim-line Tx

S.E.E.S. #	O.E.M. #	Description
MIS-SE-6	A850G7	Gate Keeper, 7' unit with hardware
MIS-SE-6A	A850G10	Gate Keeper, 10' unit with hardware
MIS-SE-6B	GLS526D	3 Lane Sensor

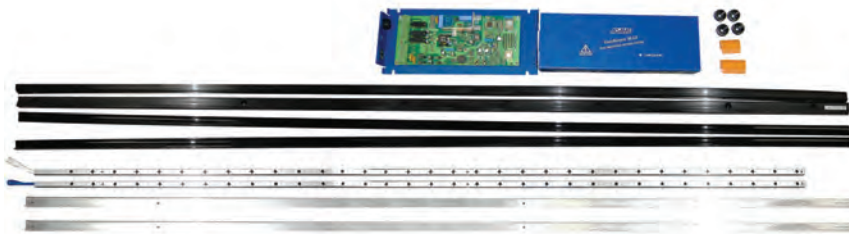

MIS-SE-6



MIS-SE-13



MIS-SE-9



MIS-SE-9E

S.E.E.S. #	Description
MIS-SE-7	SEEScreen, nudging Safety Edge set with Power Supply and hardware
MIS-SE-7N	SEEScreen, nudging Controller 115 VAC
MIS-SE-8	SEEScreen, water-proof Safety Edge set with Power Supply and hardware, IP67
MIS-SE-8A	SEEScreen, water-proof Receiver, IP67
MIS-SE-8B	SEEScreen, water-proof Transmitter, IP67
MIS-SE-9	Janus Door Edge, Pana-40
MIS-SE-9A	Janus Receiver, Pana-40
MIS-SE-9B	Janus Transmitter, Pana-40
MIS-SE-9C	Janus Power Supply, Pana-40
MIS-SE-9E	Janus Extension Cable, Pana-40 12.5' EA
MIS-SE-9F	Janus UPVC Lens cover, Pana-40
MIS-SE-9G	Janus Extension Kits, Pana-40
MIS-SE-10	Optiguard Kit
MIS-SE-11	Panachrome 3D, Complete Kit
MIS-SE-11V	Panachrome Voice Unit
MIS-SE-12	Edge Kit, Formula Systems MOVFR w/ Fully Integrate Power Supply
MIS-SE-12A	Edge Kit, Formula Systems FCU 47 MOD MOH Includes Universal Power Supply
MIS-SE-12B	Power Supply, Universal for Light Curtain 220/120 AC/DC, 24 VDC
MIS-SE-13	Panachrome Smart 3D, Complete
MIS-SE-14	Door Edge, InvisiGuard Razor, Includes Power Supply



MIS-SE-14

LOSING MONEY ON CALL BACKS?

Introducing...

SMARTORK

Elevator Hoistway
Door Closer



What does it do?

As the door closes, the innovative SMARTORK overcomes wind resistance by design. The SMARTORK, with its helical groove design, actually regains tension as it closes the door. SMARTORK provides more tension in the "door-close" cycle than it does in the "door-open" cycle. It's easy to install; just remove the "Old Style" unit and install the SMARTORK as a replacement. Call today and ask for SEES part number:

MIS-124-ST

Don't forget your brackets:

MIS-124-ST-BK

Contact Us!

800.526.0026

SMARTORK™



- 800.526.0026
- info@seesinc.com
- www.facebook.com/SEESinc

Visit Our Website:
www.seesinc.com

- ▶ The "Uni-hub" allows for easy installation
- ▶ SMARTORK saves money on non-chargeable and non-billable hours for elevator companies dealing with "Wind Resistance Issues"
- ▶ Reliable solution to nuisance call-backs
- ▶ Maintenance calls to add or remove "wraps" will virtually be a thing of the past once the SMARTORK is installed
- ▶ Rated "Green" under Energy Efficiency guidelines
- ▶ 3rd party tests over one-million cycles with virtually constant torque verify extended service-life tests
- ▶ 2 year warranty
- ▶ Made in the USA
- ▶ Acts as a safety device by securing door lock mechanisms

SMARTORK Meets or Exceeds ASME A17.1 and Related Codes

MIS-124-ST



A GREEN ENERGY PRODUCT

SMARTORK™

- ▶ SMARTORK replaces existing elevator hoistway door reel closers. SMARTORK solves many door-related problems and eliminates future maintenance.
- ▶ SMARTORK not only overcomes wind resistance but actually reduces spring force and energy required to open hoistway doors while increasing tension during close-cycle.
- ▶ SMARTORK is able to accomplish these actions by its revolutionary Patent Pending design. It's conical helix break-over design increases tension force in the last few inches of closing by an average of twenty percent more than when the door is opening. SMARTORK actually crosses the spring force ("Torque") and cable force ("Tension") ratios.

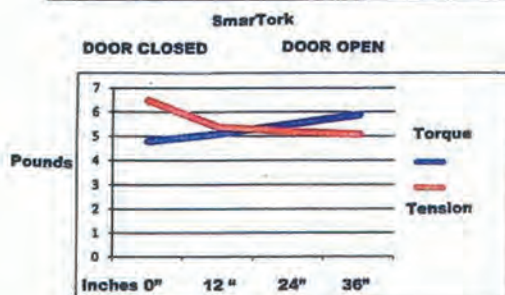
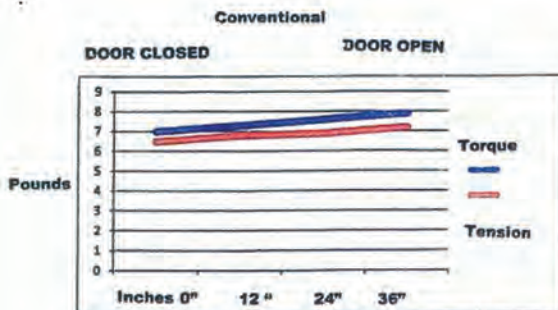

- ▶ Test have shown a reduction in Peak Amp loads by an average of .33 amps on every operation. This is a 9.2% power savings per cycle of the Elevator Door Operations. A "GREEN" energy saving product, SMARTORK, falls within ASHRAE 90.1 Guide Lines. As such, potential Tax breaks, Power rate adjustments, and Insurance Discounts may apply to building owners. SMARTORK Meets or exceeds ASME A17.1 and related Codes.
- ▶ SMARTORK reel-closer is molded from ABS Plastic to increase service life.
- ▶ The "Uni-hub" allows for easy installation or replacement to systems having a square shaft or dual pin mounting bracket configuration.
- ▶ SMARTORK saves money on non-chargeable and non-billable hours for elevator companies dealing with "Wind Resistance Issues". SMARTORK reduces maintenance costs by eliminating cord stretch and providing extended service life.
- ▶ SMARTORK was designed to replace all existing closers with a more reliable, safety enhanced and "GREEN" energy saving product.



MIS-124-ST



MIS-197



MIS-197A



MIS-197B



MIS-914A



MIS-914L



MIS-914M



MIS-914B



MIS-914F



MIS-914-TAPE



MIS-914C



MIS-914H



MIS-915

Hatch Exit

S.E.E.S. #	O.E.M. #	Description
MIS-194-AB	A835BT	Battery , 12 V 2.9 AMP HR.
MIS-197		Ceiling Emergency Latch Switch . DPDT Switch allows for building security circuit to be notified, as well as separate circuit for car shut down or, as code requires. Requires manual latch reset from car top
MIS-197A	AAA6098NS1	Top of Car Exit , contact kit, plug type
MIS-197B	USP18576	Emergency Ceiling Exit , Switch Assembly, Car Top Escape
MIS-197D	6993C64G03	Emergency Ceiling Exit , Switch Assy, Westinghouse
MIS-197E	321C984G01	Emergency Ceiling Exit , Switch Kit, Westinghouse

Electric Door Latch Assembly

S.E.E.S. #	O.E.M. #	Description
MIS-914A	A835A3	Electric Door Restrictor Hatch Latch Assembly
MIS-914B	A835PL	Plunger , Replacement for MIS-914A
MIS-914C	A835PC4	PCB , Hatch Latch, replacement for MIS-914A
MIS-914F	A835PH	PhotoEye , with bracket and 9ft cable for Hatch Latch
MIS-914G	A835SYSBK	Solenoid , with 9ft cable and bracket for Hatch Latch
MIS-914H	A835S1	Solenoid , with 9ft cable and bracket for Hatch Latch
MIS-914I	A835SBA3	Solenoid Mounting Bracket , for Hatch Latch
MIS-914J	A835ZC	Solenoid Plunger Bracket , Z-bracket for Hatch Latch
MIS-914L	A835RA	Reflective Angle , for Hatch Latch
MIS-914M	A835BB	Bracket , stop 7GA 5" x 10" for Hatch Latch
MIS-914N	A835OPTO	Door Open Pilot , OPTO Module for Hatch Latch
MIS-914-T		Reflective Targets , Alum Plate with 4" x 18" Reflective Tape
MIS-914-TAPE		Reflective Tape , 2" wide roll of 10 ft
MIS-915	9894433	Tool , Taper pin extractor
MIS-916		Power Supply , Universal, #OTIS50E-EE
MIS-917		Power Supply , Bench, 3 Outputs
MIS-918		Power Supply , 220 VAC

THE SEES RESTRICTOR

S.E.E.S. #	Description
SEES-RESTRICTOR-001	SEES Door Restrictor, Cam 60" long, with hardware and shims
SEES-RESTRICTOR-001S	SEES Door Restrictor, Cam 60" long, Shallow Design with hardware and shims
SEES-RESTRICTOR-002	SEES Door Restrictor, Cam 50" long, with hardware & shims (GAL version)
SEES-RESTRICTOR-002S	SEES Door Restrictor, Cam 50" long, Shallow Design (low profile) with hardware and shims
SEES-RESTRICTOR-003	SEES Restrictor, Flag, Small Adjustable (1.25" to 1.875")
SEES-RESTRICTOR-004	SEES Restrictor, Flag, Large Adjustable (2" to 2.875")
SEES-RESTRICTOR-004A	SEES Restrictor, Flag, Large Adjustable (2" to 3.375")
SEES-RESTRICTOR-005	SEES Restrictor, Shim Kit with hardware
SEES-RESTRICTOR-006	SEES Restrictor, Flag, 1" Fixed length
SEES-RESTRICTOR-007	SEES Restrictor, Flag, 3" Fixed length
SEES-RESTRICTOR-008	SEES Restrictor, Hardware, bag of 50 M6 Hex Hd Tek
SEES-RESTRICTOR-009	SEES Restrictor, Cam 50" Long For Swing Door Application
SEES-RESTRICTOR-010	SEES Restrictor, Cam 84" Long for Tall Doors, with hardware and shims

* see pg 568 for more information on the SEES Door Restrictor.



Single Slide Top Retainers

S.E.E.S. #	Description
DW-200	Door Retainer, for Door Track, Right Hand
DW-201	Door Retainer, for Door Track, Left Hand
SEES-TDSR-001	Top Retainer, Otis door with integral hanger
SEES-TDSR-002	Top Retainer, Otis door with type 7060 or type B hanger
SEES-TDSR-003	Top Retainer, 1" Dahlstrom or Dillon door with Horn or GAL hangers
SEES-TDSR-004	Top Retainer, 1" Dahlstrom or Dillon with MAC hangers
SEES-TDSR-005	Top Retainer, 1-1/4" Tyler, Dahlstrom Cor-o-foam door with Horn or GAL hanger
SEES-TDSR-006	Top Retainer, 1-1/4" Tyler, Dahlstrom Cor-o-foam door with MAC hanger
SEES-TDSR-007	Top Retainer, 1-1/4" Tyler door with Westinghouse hanger and Tyler gib
SEES-TDSR-008	Top Retainer, 1-1/4" Armor 4C door with 4C hanger and aluminum sill
SEES-TDSR-009	Top Retainer, Dover or Turnbull Door with integral hangers
SEES-TDSR-009A	Top Retainer, SS Dover or Turnbull Door with integral hangers, 1-1/8" Door
SEES-TDSR-010	Top Retainer, Landing Door with Roelefsen hangers
SEES-TDSR-011	Top Retainer, Landing Door equipped with Armor or GAL hangers and vandal-proof GAL lock
SEES-TDSR-012	Top Retainer, Dillon landing door with custom made hanger
SEES-TDSR-013	Top Retainer, Dillon landing door with custom made hanger, special
SEES-TDSR-030A	Top Retainer, CP Otis door with individual hangers, top retainers only
SEES-TDSR-044	Top Retainer, CP Otis door with individual hangers, top retainers only



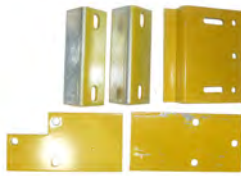

SEES-TDSR-016



SEES-TDSR-017

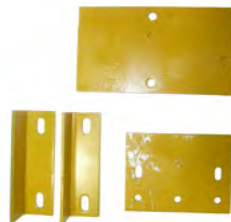

SEES-TDSR-019



SEES-TDSR-026



SEES-TDSR-037



SEES-TDSR-038

Single Slide Top Retainers

S.E.E.S. #	Description
SEES-TDSR-014	Top Retainer , Turnbell landing door with individual hangers
SEES-TDSR-015	Top Retainer , Dover landing door with individual hangers
SEES-TDSR-016	Top Retainer , Dahlstrom landing door with MAC integral hangers
SEES-TDSR-017	Top Retainer , Dahlstrom landing door with GAL integral hangers
SEES-TDSR-018	Top Retainer , Dahlstrom landing door with Otis integral hangers
SEES-TDSR-019	Top Retainer , Westinghouse landing door with integral hangers

Two Speed Top Retainers

S.E.E.S. #	Description
SEES-TDSR-020	Top Retainer , Two Speed GAL door with Gal Hangers (wide doors)
SEES-TDSR-021	Top Retainer , Two Speed Dahlstrom door with integral hangers
SEES-TDSR-022	Top Retainer , Two Speed Otis door with individual hangers
SEES-TDSR-023	Top Retainer , Two Speed Turnbull door with individual hangers
SEES-TDSR-024	Top Retainer , Two Speed MAC Door with individual hangers
SEES-TDSR-025	Top Retainer , Two Speed Dover Door with individual hangers
SEES-TDSR-026	Top Retainer , Two Speed GAL Door with GAL hangers (narrow door)
SEES-TDSR-027	Top Retainer , Two Speed Armor Door with individual hangers
SEES-TDSR-028	Top Retainer , Two Speed Otis Door with integral hangers
SEES-TDSR-029	Top Retainer , Two Speed Dover Door with integral hangers

Center Parting Top Retainers

S.E.E.S. #	Description
SEES-TDSR-030	Top Retainer , Center Parting Otis door with individual hangers
SEES-TDSR-031	Top Retainer , Center Parting Dahlstrom door with individual MAC hangers
SEES-TDSR-032	Top Retainer , Center Parting Dahlstrom door with integral hangers
SEES-TDSR-033	Top Retainer , Center Parting Armor Door with individual hangers on "J" track
SEES-TDSR-034	Top Retainer , Center Parting Turnbull door with individual hangers
SEES-TDSR-035	Top Retainer , Center Parting Dillon Door with Individual MAC hangers
SEES-TDSR-036	Top Retainer , Center Parting Otis Door with integral hangers
SEES-TDSR-037	Top Retainer , Center Parting door with Westinghouse individual hanger
SEES-TDSR-038	Top Retainer , Center Parting door with Dover integral hangers
SEES-TDSR-039	Top Retainer , Center Parting door with Westinghouse integral hangers
SEES-TDSR-040	Top Retainer , Center Parting door 1-1/4" thick with GAL individual hangers
SEES-TDSR-042	Top Retainer , Center Parting Otis door with individual hangers
SEES-TDSR-043	Top Retainer , Center Parting Dillon door with custom made hangers

Center Parting Two Speed Top Retainers

S.E.E.S. #	Description
SEES-TDSR-041	Top Retainer , Center Parting Two Speed Dover door with individual hangers

ELECTRICAL COMPONENTS

QUICK LOCATOR GUIDE

3M Products	267
Alarm Bells, Gongs	272
Batteries	270-271
Carbon Brushes	280
Carbon Contacts	276-279
Coils	280, 295, 305
Connectors, Cable Ties	267
Contact Kits	276-279
Contactors	292-306
Fans	308
Fuse Puller	266
Fuses	264-266
Motor Starters	301
Motors	273-275
Printed Circuit Boards	281
Rectifiers	281
Relay Testers	282
Relays	283-290
Resistors and Mounting Brackets	307, 309-310
Solid State Starters	301
Switches, Magnetic & Limit	290-291
Tape, Electric and Marking	267
Terminal Crimping Tools	267
Terminals	268
Zip Ties	269



Fuses



NLN Series

■ NLN Series: 9/16" Diameter x 2" L.
Packaged 10 Per Carton.

■ 1 - 30 Amps = 2" L ■ 40 Amps = 3" L



313 Series

■ 313 Series: 1/4" Dia. x 1-1/4" L.
Packaged 5 Per Carton.

One Time Fuses

S.E.E.S. #	O.E.M. #	Amperage	Voltage
F-30	NLN 1, OTN 1, NON 1	1 Amps	250 VAC
F-31	NLN 2, OTN 2, NON 2	2 Amps	250 VAC
F-33	NLN 3, OTN 3, NON 3	3 Amps	250 VAC
F-34	NLN 4, OTN 4, NON 4	4 Amps	250 VAC
F-35	NLN 5, OTN 5, NON 5	5 Amps	250 VAC
F-36	NLN 6, OTN 6, NON 6	6 Amps	250 VAC
F-37	NLN 7, OTN 7, NON 7	7 Amps	250 VAC
F-37A	NLN 8, OTN 8, NON 8	8 Amps	250 VAC
F-38	NLN 10, OTN 10, NON 10	10 Amps	250 VAC
F-39	NLN 12, OTN 12, NON 12	12 Amps	250 VAC
F-40	NLN 15, OTN 15, NON 15	15 Amps	250 VAC
F-41	NLN 20, OTN 20, NON 20	20 Amps	250 VAC
F-42	NLN 30, OTN 30, NON 30	30 Amps	250 VAC
<hr/>			
F-43	NLN 40, OTN 40, NON 40	40 Amps	250VAC



312 Series

■ 312 Series: 1/4" Dia. x 1-1/4" L.
Packaged 5 Per Carton.

Glass Fuses

S.E.E.S. #	O.E.M. #	Amperage	Voltage
F-15	312.125, GGC 1/8	1/8 Amps	250 VAC
F-16	312.250, GGC 1/4	1/4 Amps	250 VAC
F-17	312.500, GGC 1/2	1/2 Amps	250 VAC
F-17A	312.750, GGC 3/4	3/4 Amps	250 VAC
F-18	312001, GGC 1	1 Amps	250 VAC
F-19	312002, GGC 2	2 Amps	250 VAC
F-20	312003, GGC 3	3 Amps	250 VAC
F-21	312004, GGC 4	4 Amps	250 VAC
F-22	312005, GGC 5	5 Amps	250 VAC
F-23	312006, GGC 6	6 Amps	250 VAC
F-24	312007, GGC 7	7 Amps	250 VAC
F-25	312008, GGC 8	8 Amps	250 VAC
F-26	312010, GGC10	10 Amps	250 VAC
F-27	F3.15AL250VP	3.15 Amps	250 VAC

Slo-Blo Glass Fuses

S.E.E.S. #	O.E.M. #	Amperage	Voltage
F-1SB	313.010, MDL 1/100	1/100 Amps	250 VAC
F-2SB	313.031, MDL 1/32	1/32 Amps	250 VAC
F-4SB	313.062, MDL 1/16	1/16 Amps	250 VAC
F-5SB	313.100, MDL 1/10	1/10 Amps	250 VAC
F-6SB	313.125, MDL 1/8	1/8 Amps	250 VAC
F-7SB	313.150, MDL 15/100	15/100 Amps	250 VAC
F-8SB	313.175, MDL 175/100	175/1000 Amps	250 VAC
F-9SB	313.187, MDL 3/16	3/16 Amps	250 VAC
F-10SB	313.200, MDL 2/10	2/10 Amps	250 VAC
F-11SB	313.250, MDL 1/4	1/4 Amps	250 VAC
F-12SB	313.300, MDL 3/10	3/10 Amps	250 VAC
F-13SB	313.375, MDL 3/8	3/8 Amps	250 VAC
F-14SB	313.400, MDL 4/10	4/10 Amps	250 VAC
F-15SB	313.500, MDL 1/2	1/2 Amps	250 VAC
F-16SB	313.600, MDL 6/10	6/10 Amps	250 VAC
F-17SB	313.700, MDL 7/10	7/10 Amps	250 VAC
F-18SB	313.750, MDL 3/4	3/4 Amps	250 VAC
F-19SB	313.800, MDL 8/10	8/10 Amp	250 VAC
F-20SB	313.001, MDL 1	1 Amps	250 VAC
F-21SB	3131.25, MDX/MDL 1-1/4	1-1/4 Amps	250 VAC
F-22SB	31301.5, MDX/MDL 1-1/2	1-1/2 Amps	250 VAC
F-23SB	31301.6, MDX/MDL 1-6/10	1-6/10 Amps	250 VAC
F-24SB	31301.8, MDX/MDL 1-8/10	1-8/10 Amps	250 VAC
F-25SB	31300.2, MDX/MDL 2	2 Amps	250 VAC
F-26SB	3132.25, MDX/MDL 2-1/4	2 -1/4 Amps	250 VAC
F-27SB	31302.5, MDX/MDL 2-1/2	2 -1/2 Amps	250 VAC
F-28SB	31302.8, MDX/MDL 2-8/10	2-8/10 Amps	250 VAC
F-29SB	31300.3, MDX/MDL 3	3 Amps	250 VAC
F-30SB	31303.2, MDX/MDL 3-2/10	3-2/10 Amps	250 VAC
F-31SB	31300.4, MDX/MDL 4	4 Amps	250 VAC
F-32SB	31300.5, MDX/MDL 5	5 Amps	250 VAC
F-33SB	3136.25, MDX/MDL 6-1/4	6-1/4 Amps	250 VAC
F-34SB	31300.7, MDX/MDL 7	7 Amps	250 VAC
F-35SB	31300.8, MDL 8	8 Amps	32 VAC
F-36SB	313010, MDL 10	10 Amps	32 VAC
F-37SB	313012, MDL 12	12 Amps	32 VAC
F-38SB	313.015, MDL 15	15 Amps	32 VAC
F-39SB	313020, MDL 20	20 Amps	32 VAC
F-40SB	313.025, MDL 25	25 Amps	32 VAC
F-41SB	313.030, MDL 30	30 Amps	32 VAC

Fuses

Slo-Blo Fuses

TIME DELAY, CURRENT LIMITING

S.E.E.S. #	O.E.M. #	Amperage	Voltage
F-58B	FLN-R1.6, FRN-R1.6, TR-R1.6	1-6/10 Amps	250 VAC
F-58A	FLN-R3.2, FRN-R3.2, TR-R3.2	3-2/10 Amps	250 VAC
F-58D	FLN-R3.5, FRN-R3.5, TR-R3.5	3-1/2 Amps	250 VAC
F-58C	FLN-R4, FRN-R4, TR-R4	4 Amps	250 VAC
F-58	FLN-R6, FRN-R6, TR-R6	6 Amps	250 VAC
F-58E	FLN-R3, FRN-R3, TR-R3	3 Amps	250 VAC
F-58F	X52BS7H98	1.125 Amps	600 VAC
F-59	FLN-R10, FRN-R10, TR-R10	10 Amps	250 VAC
F-59A	FLN-R15, FRN-R15, TR-R15	15 Amps	250 VAC
F-59B	FLN-R20, FRN-R20, TR-R20	20 Amps	250 VAC
F-60	FLN-R30, FRN-R30, TR-R30	30 Amps	250 VAC
F-62	FLN-R50, FRN-R50, TR-R50	50 Amps	250 VAC
F-63	FLN-R60, FRN-R60, TR-R60	60 Amps	250 VAC
F-64	FLN-R70, FRN-R70, TR-R70	70 Amps	250 VAC
F-65	FLN-R80, FRN-R80, TR-R80	80 Amps	250 VAC
F-66	FLN-R90, FRN-R90, TR-R90	90 Amps	250 VAC
F-67	FLN-R100, FRN-R100, TR-R100	100 Amps	250 VAC
F-68	FLN-R125, FRN-R125, TR-R125	125 Amps	250 VAC
F-78A	FLS-R3, FRS-R3, TR-53	3 Amps	600 VAC
F-70	FLS-R50, FRS-R50, TR-S50	50 Amps	600 VAC
F-71	FLS-R60, FRS-R60, TR-S60	60 Amps	600 VAC
F-72	FLS-R70, FRS-R70, TR-S70	70 Amps	600 VAC
F-73	FLS-R80, FRS-R80, TR-S80	80 Amps	600 VAC
F-74	FLS-R90, FRS-R90, TR-S90	90 Amps	600 VAC
F-75	FLS-R100, FRS-R100, TR-S100	100 Amps	600 VAC
F-76	FLS-R125, FRS-R125, TR-S125	125 Amps	600 VAC
F-77	FLS-R150, FRS-R150, TR-S150	150 Amps	600 VAC
F-78	FLS-R175, FRS-R175, TR-S175	175 Amps	600 VAC

Electronic Fuses

S.E.E.S. #	O.E.M. #	Amperage	Voltage
F-80	314.50, ABC 1/2	1/2 Amps	250 VAC
F-80A	314.25, ABC 1/4	1/4 Amps	250 VAC
F-81	314001, ABC 1	1 Amps	250 VAC
F-82	314002, ABC 2	2 Amps	250 VAC
F-83	314003, ABC 3	3 Amps	250 VAC
F-84	314004, ABC 4	4 Amps	250 VAC
F-85	314005, ABC 5	5 Amps	250 VAC
F-86	314006, ABC 6	6 Amps	250 VAC
F-87	314007, ABC 7	7 Amps	250 VAC
F-88	314008, ABC 8	8 Amps	250 VAC
F-90	314010, ABC 10	10 Amps	250 VAC
F-91	314012, ABC 12	12 Amps	250 VAC
F-92	314015, ABC 15	15 Amps	250 VAC
F-93	314020, ABC 20	20 Amps	250 VAC
F-94	314025, ABC 25	25 Amps	250 VAC
F-95	314030, ABC 30	30 Amps	250 VAC
F-96	F2AH250VAC	2 Amps	250 VAC

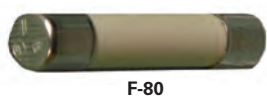

Fast Acting

S.E.E.S. #	O.E.M. #	Amperage	Voltage
F-100	0217004.HXP	4 Amps	250 VAC
F-101	0217002.HXP	2 Amps	250 VAC
F-102	021702.5HXP	2.5 Amps	250 VAC
F-103	021706.3HXP	6.3 Amps	250 VAC
F-104	0217.500HXP	.5 Amps	250 VAC
F-105	CY10X38G6	6 Amps	500 VAC
F-106	CY10X38G10	10 Amps	500 VAC
F-107	GDA-2A	2 Amps	250 VAC



Fuses



F-50



F-54

■ NLS Series: 13/16" Dia. x 5" L.
Packaged 10 Per Carton.



PICO SERIES

■ Sold 5 / pkg.



F-78B

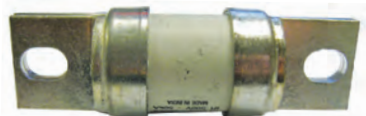

F-79



F-79B



F-79C



F-79A



F-LQ002



F-LQ03



F-LQ015



FM-100

One Time Fuses

S.E.E.S. #	Description	Amperage	Voltage
F-50	NLS 1, OTS 1, NOS 1	1 Amp	600 VAC
F-51	NLS 3, OTS 3, NOS 3	3 Amps	600 VAC
F-52	NLS 5, OTS 5, NOS 5	5 Amps	600 VAC
F-53	NLS 6, OTS 6, NOS 6	6 Amps	600 VAC
F-54	NLS 10, OTS 10, NOS 10	10 Amps	600 VAC
F-55	NLS 15, OTS 15, NOS 15	15 Amps	600 VAC
F-56	NLS 20, OTS 20, NOS 20	20 Amps	600 VAC
F-57	NLS 30, OTS 30, NOS 30	30 Amps	600 VAC

Pico Fuses

S.E.E.S.#	O.E.M. #	Amperage	Voltage
F-001	251.125	.125 Amps	250 VAC
F-002	251.250	.250 Amps	250 VAC
F-003	251.500	.500 Amps	250 VAC
F-004	251.001	1 Amps	250 VAC
F-005	251.002	2 Amps	250 VAC
F-006	251.004	4 Amps	250 VAC
F-007	251.005	5 Amps	250 VAC



F-400



F-401

Semiconductor

S.E.E.S.#	O.E.M. #	Description
F-78B		Fuse, 30 Amps, 1000VAC
F-79	L50S150	Fuse, 150A 500V, 1-7/32" x 3-5/8" L
F-79A	9816331	Fuse, 150 AMP 250V-MX
F-79B	9720650	Fuse, Semiconductor 100A /700V Sold Each
F-79C	9717080	Fuse, 40A 550V Sold Each
F-400	AAA21255J122	Fuse, 400A, 700V
F-401	AAA21255J103	Fuse, 300A, 700V

Slo-Blo Midget Fuses

S.E.E.S. #	O.E.M. #	Description	Amperage	Voltage
F-LQ001	FLQ001	Fuse, 13/32 x 1-1/2"	1 Amps	500 VAC
F-LQ1.5	FLQ001.5	Fuse, 13/32 x 1-1/2"	1-1/2 Amps	500 VAC
F-LQ002	FLQ002	Fuse, 13/32 x 1-1/2"	2 Amp	500 VAC
F-LQ003	FLQ003	Fuse, 13/32 x 1-1/2"	3 Amps	500 VAC
F-LQ004	FLQ004	Fuse, 13/32 x 1-1/2"	4 Amps	500 VAC
F-LQ008	FLQ008	Fuse, 13/32 x 1-1/2"	8 Amps	500 VAC
F-LQ010	FLQ010	Fuse, 13/32 x 1-1/2"	10 Amps	500 VAC
F-LQ12	FLQ012	Fuse, 13/32 x 1-1/2"	12 Amps	500 VAC
F-LQ015	FLQ015	Fuse, 13/32 x 1-1/2"	15 Amps	500 VAC
F-LQ020	FLQ020	Fuse, 13/32 x 1-1/2"	20 Amps	500 VAC

S.E.E.S. #	Description
FM-100	Fuse Puller Specialty Tool for easy fuse removal and replacement



3M Products

S.E.E.S. #	Description
3M-1	Terminal Crimping Tool , wire stripper and wire or bolt cutter. Made of .125" heat-treated carbon steel with cushioned vinyl handles. For insulated and non-insulated wire 22-10.
3M-2	Terminal Crimping Tool , (as above) for wire 26-6

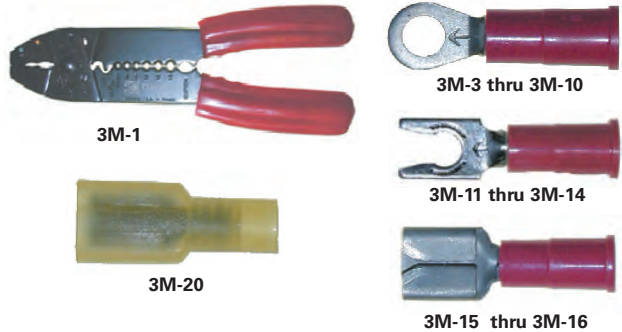

Terminals

S.E.E.S. #	Description
3M-3	Wire Range: 22-18 Stud #6
3M-4	Wire Range: 22-18 Stud #8
3M-5	Wire Range: 22-18 Stud #10
3M-6	Wire Range: 16-14 Stud #6
3M-7	Wire Range: 16-14 Stud #8
3M-8	Wire Range: 16-14 Stud #10
3M-9	Wire Range: 26-24 Stud #4
3M-10	Wire Range: 26-24 Stud #6
3M-11	Wire Range: 22-18 Stud #6
3M-12	Wire Range: 22-18 Stud #10
3M-13	Wire Range: 16-14 Stud #6

S.E.E.S. #	Description
3M-14	Wire Range: 16-14 Stud #10
3M-15	Female Quick Slide 22-18
3M-16	Female Quick Slide 16-14
3M-20	Female Quick Slide 16-14
3M-22	Male Quick Slide 16-14
3M-23	Male Quick Slide 16-14



Connectors

S.E.E.S. #	Description
3M-24	Wire Range 22-18
3M-25	Wire Range 16-14
3M-26	Female Self-Strip 22-18
3M-27	Female Self-Strip 18-14
3M-28	Female Self-Strip
3M-29	Pigtail Self-Strip Red
3M-30	Self-Stripping Red 22-16
3M-31	Self-Stripping Blue 14-18
3M-32	Yellow, Spring Connect, 12-22
3M-33	Red, Spring Connect, 8-16

S.E.E.S. #	Description
3M-33	Red, Spring Connect, 8-16
3M-34	Yellow, Spring Connect, 10-22
3M-35	Red, Spring Connect, 10-18
3M-36	Grey, Spring Connect, 8-14
3M-37	Blue, Spring Connect, 6-12
3M-48	Female Faston Connector, .187
3M-49	Butt Splice Connector
3M-50	Butt Splice Connector, 14-22
3M-51	Female Faston Connector, .187
3M-52	Female Faston Connector, .250

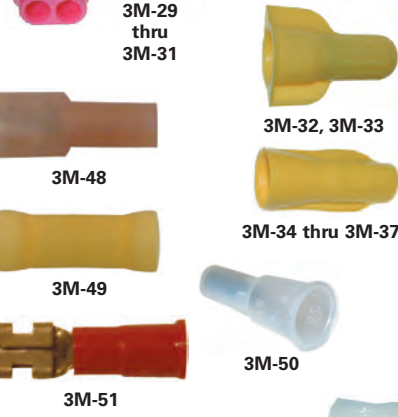

Electrical Tape

S.E.E.S. #	Description
3M-46	Super 33+ Scotch Brand Premium 7 mm flame retardant, weather resistant tape. Resists temperature and moisture for splicing. Canned Rolls 3/4" x 66 ft
3M-47	Economy-grade, 7 mm vinyl plastic electrical tape. UL listed. Standard Rolls 3/4" x 66 ft
3M-TAPE	Electrical Tape , Black Cloth 60'
3M-TAPE-R	Electrical Tape , Black Rubber 22'



Marking Tape

S.E.E.S. #	Description
3M-43	Scotchcode Wire Marker Tape Dispenser filled w/ numeral series 0-9
3M-43A	Tape Dispenser Refill, numeral series 0-9, 10 rolls per box
3M-44	Scotchcode Wire Marker Tape Dispenser filled with colors
3M-44A	Tape Refill, assorted colors for dispenser 3M-44
3M-45	Wire Marker Book, 45 ea 0-9; 15 ea L1, L2, L3, T1, T2, T3, (0-9). 50 / Box

Cable Ties

S.E.E.S. #	Description
3M-38	3-3/4" flexible nylon 100/bag
3M-39	5-7/8" flexible nylon 100/bag
3M-40	7-15/16" flexible nylon 100/bag
3M-41	12-1/16" flexible nylon 100/bag
3M-42	8-5/16" flexible nylon 100/bag



Terminals

Wire Terminals

S.E.E.S. #	Description
WT-BC-16-14	Butt Connector 16-14 AWG Blue Wire Terminal
WT-BC-12-10	Butt Connector 12-10 AWG Yellow Wire Terminal
WT-BC-22-18	Butt Connector 22-18 AWG Red Wire Terminal
WT-FF-16-14	Female Faston 16-14 AWG Blue Wire Terminal
WT-FF-22-18	Female Faston 22-18 AWG Red Wire Terminal
WT-WN-18-12	Wire Nut 18-12 AWG Yellow Wire Terminal, Pack of 100
WT-WN-22-12	Wire Nut 12-10 AWG Yellow Wire Terminal
WT-WN-22-14	Wire Nut 12-14 AWG Blue Wire Terminal, Pack of 100
WT-SS-22-16	Pigtail Self Strip 22-16 AWG R Wire Terminal
WT-SS-18-14	Pigtail Self Strip 18-14 AWG B Wire Terminal
WT-RT-22-18-8	Ring Terminal #8 Stud 22-18 AWG Red, Wire Terminal
WT-RT-22-18-6	Ring Terminal #6 Stud 22-18 AWG Red, Wire Terminal
WT-RT-16-14-8	Ring Terminal #8 Stud 14-16 AWG Blue, Wire Terminal
WT-RT-16-14-6	Ring Terminal #6 Stud 14-16 AWG Blue, Wire Terminal
WT-RT-16-14-10	Ring Terminal #10 Stud 14-16
WT-MF-16-14-I	Male Faston 16-14 AWG Blue Wire Terminal
WT-MF-16-14	Male Faston 16-14 AWG Blue Wire Terminal
WT-KIT-180	Kit 180pc Assortment 22-10 AWG 18 Types, Wire Terminal
WT-FT-22-18-6	Fork Terminal #6 Stud 22-18 AWG Red, Wire Terminal
WT-FT-16-14-6	Fork Terminal #6 Stud 16-14 AWG Blue, Wire Terminal
WT-FT-16-14-10	Fork Terminal #10 Stud 16-14 AWG Blue, Wire Terminal
WT-FFSS-22-18	Female Faston Self Strip 22-18 AWG Red, Wire Terminal
WT-FFSS-18-14	Female Faston Self Strip 22-18 AWG Red, Wire Terminal
WT-FFSS-12-10	Female Faston Self Strip 12-10 AWG Yellow, Wire Terminal
WT-FF-22-18-RI	Female Faston 22-18 AWG Red .187, Wire Terminal
WT-FF-22-18-I	Female Faston 22-18 AWG Red .187, Wire Terminal
WT-MF-22-16	Male Faston 22-16 AWG Red Wire Terminal



WT-MF-16-14



WT-FT-16-14-6



WT-FT-16-14-10



WT-FF-22-18-I

Zip Ties

Zip Ties

S.E.E.S #	Description
ZIP-TIE-004	Cable tie, 4" Pack of 100
ZIP-TIE-006	Cable tie, 6" Pack of 100
ZIP-TIE-008	Cable tie, 8" Pack of 100
ZIP-TIE-010	Cable tie, 10" Pack of 100
ZIP-TIE-012	Cable tie, 12" Pack of 100
ZIP-TIE-014	Cable tie, 14" Pack of 100
ZIP-TIE-015	Cable tie, 15" Pack of 100
ZIP-TIE-020	Cable tie, 20" Pack of 100
ZIP-TIE-020-Y	Cable tie, 20" Safety Yellow Pack of 100
ZIP-TIE-047	Cable tie, 47" Black Pack of 100
ZIP-TIE-047-W	Cable tie, 47" White Pack of 100



ZIP-TIE-004



ZIP-TIE-006



ZIP-TIE-012



ZIP-TIE-014



ZIP-TIE-015



ZIP-TIE-020



ZIP-TIE-020-Y



Batteries



Sealed and maintenance free, these batteries offer an excellent service life of 4 - 5 years, and a shelf life of over 1 year. Protective covering made of a non-conductive polystyrene is resistant to shock, vibration, chemicals and heat.



MIS-194



MIS-194-AB



MIS-194AA



MIS-194AB



MIS-194AC



MIS-194B

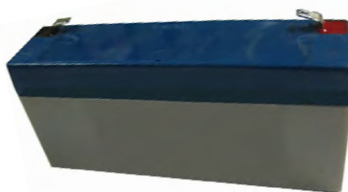

MIS-194C



MIS-194D

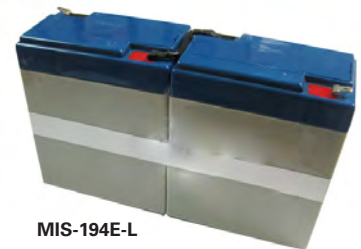

MIS-194E-L



MIS-194E-S



MIS-194F



MIS-194G



MIS-194I

S.E.E.S. #	O.E.M. #	Capacity Voltage	Amp Hours	Dimensions
MIS-194	2005, PS 1/2 D CELL/4	4.8V	2.2AH	5-3/4" L x 1-1/4" diameter, 5 D cells "Dynamite Stick"
MIS-194-AB	PS1229, A835BT	12V	2.9A	7" L x 1-1/2" W x 2-1/4" H
MIS-194AA	BR3032	3V	500mAH	1.181" diameter x .126" thick
MIS-194AB	SR44, 357, 1154	1.5V	180mAH	1.181" diameter
MIS-194AC		6V	700mAH	For Draka Seismic Sensor
MIS-194B	9880719, AAA718E7, A911X3	6V	7AH	5.95" L x 1.34" W x 3.7" H
MIS-194C	PS630	6V	3AH	5.28" L x 1.34" W x 2.35" H
MIS-194D	PS-12100-F2, 718AAC1, AAA718EI	12V	10AH	6" L x 4" W x 3.7" H
MIS-194E-L	PS1282L	12V	8AH	7.72" L x 2.2" W x 4.65" H
MIS-194E-S	PS-1282S	12V	8AH	4.4" L x 3.86" W x 4.65" H
MIS-194F	PS682F, EP680 AAA718E10	6V	8AH	3.86" L x 2.2" W x 4.65" H
MIS-194G	PS-6120, EP-695, PS695	6V	12AH	4.25" L x 2.75" W x 5.51" H
MIS-194I	A19390-2, BA70001N, GL-1200E, BAT-0001N	6V	4.0AH	3-3/4" L x 2-1/2" H, 5 D cells stacked 2 on 3 (for GAL)
MIS-194I-RES	BAT-0002N	12V		Rescuvator-Model 5, hardware included 8.61" L x 5.29" W x 8.79" H

Call S.E.E.S. for all of your emergency light replacement batteries.

Batteries

S.E.E.S. #	O.E.M. #	Capacity Voltage	Amp Hours	Dimensions
MIS-194J	PS6100-F1, A911X3	6V	10AH	6" L x 2" W x 3.75" H
MIS-194K	9719891, CR2430	3V		1" diameter, Lithium
MIS-194M	PS-121000U, AAA718E1, AAA718G4	12VDC	100AH	12" x 6.6" x 8.15"
MIS-194N	116AM1, CR2032, XBAT005	3V		1" diameter, Lithium
MIS-194P	PS1230	12V	3AH	5.28" L x 2.64" W x 2.36" H
MIS-194-PH-BATT		8.4V	600mAH	Battery, Replacement for ET901 Series Phones
MIS-194Q	EP640	6V	4.6A	2.67" L x 1.87" W x 4.25" H
MIS-194R	AAA718E6, PS-6100F2	6V	12A	5.95" L x 2" x 3.70"
MIS-194S	AAA718E7, PS-670	6V	7A	5.95" L x 1.34" W x 3.70" H
MIS-194T	AAA718E3, PS-1250, 335802-01	12V	5AH	3.54" L x 2.76" W x 3.98" H
MIS-194V	GA313462001	12V	14AH	8.5" L x 2.79" W x 5.51" H
MIS-194W	PS1250F2	12V	5AH	Emerg Lowering for R&R unit 2 Req
MIS-194X	PS1270, AAA718E5, AAA718E14	12V	7A	5.95" L x 2.76" W x 3.70" H
MIS-194Y	PS-6200	6V	20A	6.18" L x 3.27" W x 4.92" H
MIS-914-BAT	PS-1220	12V	2.5AH	7" L x 1.38" W x 2.56" H
MIS-CD7	EY9106B	12V	2AH	
MIS-CD8	EY9021B	2.4V	2AH	
MIS-CD9	EY9080B	9.6V	1.2AH	
NP24-12B	PS12260NB	12V	26AH	EPCO Battery for emergency lighting 6-1/2" L x 7" W
TPC-37A-BAT	PS-1212	12V	1.4AH	3.78" L x 1.69" W x 2.04" H

Call S.E.E.S. for all of your emergency light replacement batteries.

S.E.E.S.#	Description
12V-GB-KIT	Kit, PCB and Battery for 12V Gell Pack
6V-GB-KIT	Kit, PCB and Battery for 6V Gell Pack
SEISMIC-BATTERY	Replacement Battery, Seismic Sensor



MIS-194N



MIS-194I-RES



MIS-194J



MIS-195K



MIS-194M

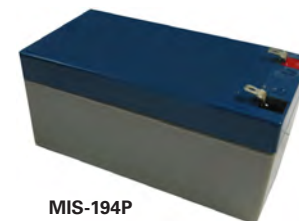

MIS-194P



MIS-194Q



MIS-194R



MIS-194S



MIS-194T



MIS-194X



MIS-914-BAT



NP24-12B



TPC-37A-BAT



Alarm Bells

Easy to install, alarm bells have a strong, simplified mechanical construction which requires less maintenance time. Rugged construction with rust-protected finish provide reliable performance for both indoor and outdoor use.



MIS-125



MIS-125A



MIS-125B



MIS-125D



MIS-125E



MIS-125F



MIS-125G



MIS-125N



MIS-125M



MIS-125Q



1000-03-10



1000-04-10

S.E.E.S. #	O.E.M. #	Description
MIS-125		Brass Gong, single stroke, 115 VAC 2K ohm
MIS-125A		Brass Gong, 2-1/2" diameter, single stroke, 40 Watt Series
MIS-125B		Brass Gong, 2-1/2" diameter, single stroke, 25 Watt Series
MIS-125D		Alarm Bell, 12 VDC, 6" diameter
MIS-125E		Alarm Bell, 120 VAC, 6" diameter
MIS-125F		Alarm Bell, Flash type, 120 VAC, 6" diameter, with flashing red light
MIS-125G		Alarm Bell Mounting Box, Red plastic 4" square surface mount with gasket, water resistant
MIS-125M		Alarm Bell Mounting Box, Red plastic
MIS-125N		Alarm Bell, 6" 6 VDC Nylube 92db .15 ma
MIS-125Q		Alarm Bell, 6" 6 VDC 92db .15 ma black bell
1000-03-10	1000-03-10	EPCO Alarm Bell, 6V bell, 6
1000-04-10	1000-04-10	EPCO Alarm Bell, 24V bell, 6
EPP-001	1000-02-01	EPCO Power Pack, 12V
EPP-001A	1000-03-01	EPCO Power Pack, 6V
EPP-002	1000-02-02	EPCO Power Pack, 12V with light
EPP-002A	1000-03-02	EPCO Power Pack, 6V with light
EPP-003	1000-02-03	EPCO Power Pack, 12V with bell
EPP-003A	1000-03-03	EPCO Power Pack, 6V with bell
EPP-004	1000-02-04	EPCO Power Pack, 12V with light, bell, & GFI
EPP-004A	1000-03-04	EPCO Power Pack, 6V with light, bell, & GFI

Motors

Submersible Pump Motors

S.E.E.S. #	Description
HYSM-001	Motor, Hydraulic Submersible Pump 20 H.P., 3900 RPM 200V, 80S
HYSM-002	Motor, Hydraulic Submersible Pump 20 H.P., 3900 RPM 230-460V, 80S
HYSM-003	Motor, Hydraulic Submersible Pump 25 H.P., 3900 RPM 200V, 80S
HYSM-004	Motor, Hydraulic Submersible Pump 25 H.P., 3900 RPM 230-460V, 80S
HYSM-005	Motor, Hydraulic Submersible Pump 30 H.P., 3900 RPM 200V, 80S
HYSM-006	Motor, Hydraulic Submersible Pump 30 H.P., 3900 RPM 230-460V, 80S
HYSM-007	Motor, Hydraulic Submersible Pump 40 H.P., 3900 RPM 200V, 80S
HYSM-008	Motor, Hydraulic Submersible Pump 40 H.P., 3900 RPM 230-460V, 80S
HYSM-009	Motor, Hydraulic Submersible Pump 50 H.P., 3900 RPM 200V, 80S
HYSM-010	Motor, Hydraulic Submersible Pump 50 H.P., 3900 RPM 230-460V, 80S
HYSM-011	Motor, Hydraulic Submersible Pump 15 H.P. 200V, 80S
HYSM-012	Motor, Hydraulic Submersible Pump 15 H.P. 230-460V, 80S
HYSM-A01	Flange Adaptor Plate, Motor to Pump 8-1/8" to 10-1/4"

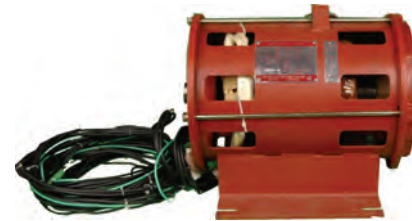

HYSM-001 thru -010

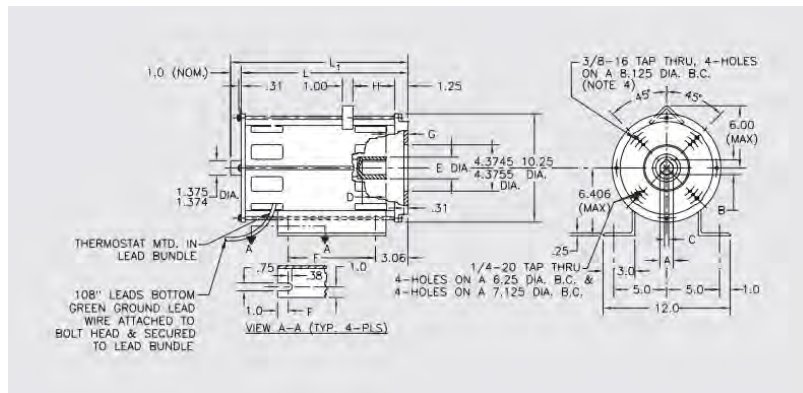

Door Motors

S.E.E.S. #	O.E.M. #	Description
DDO-31	9746602	Motor , Door Operator, 1/6 HP, 1140 RPM, 230 VDC, permanent magnet
DDO-31E	9801704, 141707	Motor , Door Operator, 1/6 HP, 1340 RPM, 115 VDC, permanent magnet, uses DCH-18
DDO-31EA	9872070	Motor , Door Operator, 1/6 HP, 1145 RPM, 230 VDC, permanent magnet
DDO-46	9779504	Motor , Door Operator, with encoder
DDO-47	9841775	Motor , Door Operator, with Pulse Tach
GDO-24	MOD Type	Motor , Door Operator, 1/6 HP, 1140 RPM, 230 VDC, MOD Type, Shunt wound
GDO-24B	MOM Type	Motor , Door Operator, 1/4 HP, 1150 RPM, 230 VDC, MOM Type, Shunt wound
GDO-24C	MTR-0009M	Motor , Door Operator, 1/4 HP, 1140 RPM, 230 VDC, permanent magnet
GDO-24D	MTR-0008N-PM	Motor , Door Operator, 1/6 HP, 1140 RPM, 230 VDC, MOD Type, permanent magnet
GDO-24E	MTR-0011N	Motor , Door Operator, 1/6 HP, 1140 RPM, 115 VDC, MOD Type, permanent magnet
GDO-24F	MTR-0010N	Motor , Door Operator, 1/2 HP, 1140 RPM, 230 VDC, MOH Type, permanent magnet
GDO-24H	MTR-0021N	Motor , Door Operator, 1/2 HP, 230 VDC, 3 phase, MOVFR, MOVFR 2, MOVFR-RND 2
HDO-5	3-40144-36	Motor , Door Operator, T-1, 1/4 HP, 1140 RPM, 230 VDC, uses HCB-5 brush
HDO-5A	3-40196-50	Motor , Door Operator, T-H 1/2 HP, 1140 RPM, 230 VDC
HS-3	3-26123-00	Motor , Selector motor, Vernier B1, .4 Amps, 72 RPM, 120 VAC
HS-3A	3-26123-12	Motor , Selector motor, Vernier B1 72 RPM 230-240 VAC
MDO-29	MA1555, MA1604	Motor , Door Operator, 1/6 HP, 1140 RPM, 230 VDC, type NC O-55, 6 wire lead, 5/8" shaft diameter
MDO-29A	49743	Motor , Door Operator, permanent magnet, 1/6 HP, 1140 RPM, 24 VDC, 3-1/4" diameter, 8-1/2" L, uses MCB-10 brush
MDO-29C	19144	Motor , Door Operator, 1/3 HP, 115-230 VDC, 3450 RPM, dampening, FT Mount



DDO-31

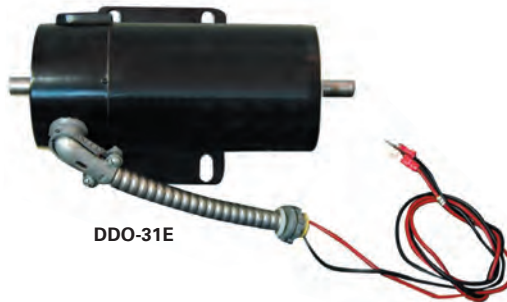

DDO-31E



GDO-24

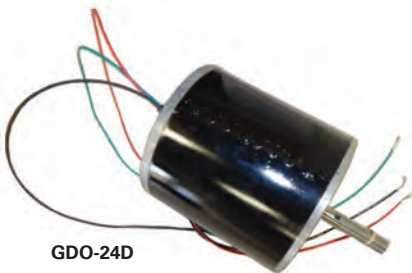

GDO-24D



GDO-24F



HDO-5



MDO-29



MDO-29A



HS-3



HS-3A



MDO-29C

Door Motors

S.E.E.S. #	O.E.M. #	Description
ODO-75	6333AJ1, 6333AL1	Motor , Door Operator, 1/2 HP, 115-230 VDC, 1750 RPM, 1/2" shaft, 1/8" key
ODO-75A	6333BX1	Motor , Door Operator, 32 oz/ft, 230 VAC, 900 RPM, 60 cycle, single phase
ODO-75B	6333AM1	Motor , Door Operator, 32 oz/ft, 230 VAC, 900 RPM, 60 cycle, 3 phase
ODO-75C	6333CC2	Motor , Door Operator, Gear Assy., 69 RPM, 90VDC, 190in./lb. torque
ODO-75CD-A	6800JC1	Adaptor Plate , for new style ODO-75C&D Motors
ODO-75D	6333CC1	Motor , Door Operator, 100-110 RPM, 90 VDC, 190in./lb. torque
OS-70	A6333E1	Motor Selector , 60 VDC
THLM-002	IR3507M	Motor , .75HP, 1725 RPM, 1 PH, 60 HZ, 56,3524L, TEFC F1
WDO-61	681A554H01 146A444H01	Motor , Door Operator, 1/6 HP, 2000 RPM, 125 VDC, 1.3 Amp, shunt wound
WCB-142		Carbon Brush , for WDO-61
WDO-61F	151B420G01	Motor , Door Operator, 1/6 HP, 2000 RPM 125 VDC, 1.3 Amp, shunt wound, WDO-61 with pulley, 16 teeth
WDO-61G	692B863G01	Motor , Door Operator, 1/6 HP, 1150 RPM 170 VDC, 1.3 Amp, permanent magnet
WDO-61J	7285C56H01	Motor , Schindler Door 1/6HP, 1140 RPM, 170 VDC
WRP-46	569A803H01	Motor , Tach generator, 30 VDC
WRP-46A	198C030H02	Motor , Tach generator 60 VDC
PDO-001	056910M	Door Motor , Peele 900/450Rpm 200/220 VAC



ODO-75



ODO-75C



ODO-75D

Fermator Parts

S.E.E.S. #	O.E.M. #	Size
FDM-001	VF00.C000 MODVVVF	Motor , Fermator door operator, 900 RMP 250 Watt 125-78/40 Volts
F-BELT-1	HTD 5M	Fermator Door Belt
F-BELT-001	913510011	Belt , Toothed for Fermator 5mm pitch 12mm wide 2500 long HTD-5M-12 Prem.
F-BELT-002	9190045	Belt , Timing/Toothed for Fermator 5mm pitch 12mm wide 4000 long HTD-5M-12
F-BELT-003	913510086	Belt , Timing/Toothed for Fermator 5mm pitch 12mm wide 5000 long HTD-5M-12
F-BELT-004	913510089	Belt , Toothed for Fermator 5mm pitch 12mm wide 1600 long HTD-5M-12 50/11VF
F-DC-1		Door Controller , Fermator VVVF
F-DS-1		Fermator , Door Slider
F-DL-2C		Fermator , Door Lock Contact
F-DL-3C		Fermator , Door Lock Contact



OS-70



THLM-002



WDO-61



WDO-61F



WDO-61G

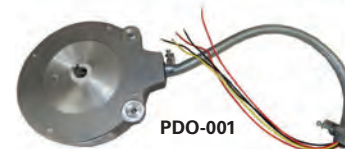

PDO-001



WRP-46



FDM-001



F-BELT-001

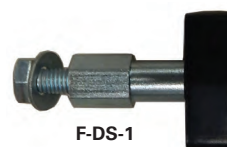

F-DS-1



F-DL-2C



Contact Kits



CKAB-4



CKAB-11



CKAB-11



CKAB-12



CKABB-130-1NC



CKABB-130-2NO



CKABB-EH145



CKARO-1



CKARO-6



CKCH-12

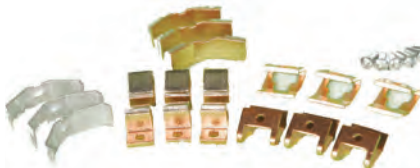

CKCH-13



CKF-1



CKF-3



CKF-5

Contact Kits for Allen Bradley

S.E.E.S. #	O.E.M. #	Size
CKAB-1	Z-21101	00, 2 Pole Series K
CKAB-2	Z-21102	00, 3 Pole
CKAB-3	Z-21103	00, 4 Pole
CKAB-4	Z-34037	0, 1 Pole
CKAB-5	Z-34038	1, 1 Pole
CKAB-6	Z-34039	2, 1 Pole
CKAB-7	Z-34040	3, 1 Pole
CKAB-8	Z-34041	4, 1 Pole
CKAB-9	40410-331-51	0, 1 Pole Bulletin 500
CKAB-10	40410-331-52	1, 1 Pole
CKAB-11	40420-322-51	2, 1 Pole
CKAB-12	40430-300-51	3, 1 Pole
CKAB-13	40440-300-51	4, 1 Pole
CKAB-14	42450-805-01	5, 1 Pole

S.E.E.S. #	Description
CKABB-130-1NC	Contact Kit, EHDB130 1 N.C.
CKABB-130-2NO	Contact Kit, EHDB130 2 N.O.
CKABB-EH145	Contact Kit, 3 Pole, EH145
CKABB-280-2NO	Contact Kit, EHDBCK280 2 N.O.

Contact Kits for Aromat

S.E.E.S. #	O.E.M. #	Size, Poles	Contact Size Movable / Stationary
CKARO-1	BM6-35-901	1++ 3 P	1-1/2 x 1/4 / 1 3/8 x 1/2
CKARO-2	BM6-50-901	2+ 3 P	1-1/2 x 1/4 / 1-3/8 x 1/2
CKARO-3	BM6-65-901	2++ 3 P	1-7/8 x 3/16 / 1-7/16 x 5/8
CKARO-4	BM6-80-901	3 3 P	1-7/8 x 3/16 / 1-7/16 x 5/8
CKARO-5	BM6-85-901	3+ 3 P	1-7/8 x 1/4 / 1-3/4 x 5/8
CKARO-6	BM6-190-901	4+ 3 P	2-3/4 x 5/8 / 1-9/16 x 7/8

Contact Kits for Arrow Hart

S.E.E.S. #	O.E.M. #	Size
CKAH-2	38640-301, Model 1-64	3, 1 Pole

Contact Kits for Cutler Hammer

S.E.E.S. #	O.E.M. #	Size
CKCH-12	6-27-2	Size 5, 3 Pole Kit
CKCH-13	6-43-2	Size 3 / m # 6-43-2
CKCH-14	6-65-6	3 Pole, 1-3/4" H, Armor/Kone US518540
CKCH-20	6-36-2	Series B1, 200A

Contact Kits for Furnas

S.E.E.S. #	O.E.M. #	Size	Contact Size Movable / Stationary
CKF-1	75FB14A	Size 2, 1 Pole	1-15/16 x 1/2 / 1-15/16 x 1/2
CKF-2	9790172	Size 2-1/2, 1 Pole	1-15/16 x 1/2 / 1-15/16 x 1/2
CKF-3	75HB14	Size 3, 1 Pole	2-1/8 x 3/8 / 1-1/2 x 1/2
CKF-4	75IB14	Size 3-1/2, 1 Pole	2-1/8 x 3/8 / 1-1/2 x 1/2
CKF-5	75JB14	Size 4, 1 Pole	2-1/8 x 3/8 / 1-3/4 x 3/16

Contact Kits



1 Pole Contact Kits for Furnas

S.E.E.S. #	O.E.M. #	Size	Contact Size - Movable / Stationary
CKF-6	75RB14	Size 4-1/2, 1 Pole	3 x 1-3/4 x 1 x 3
CKF-7	75KB14	Size 5, 1 Pole	3-3/8 x 1-1/32 / 3/4 x 1-1/32 x 3
CKF-8	75DF14	Size 1, 1 Pole	1-1/4 x 3/8 / 1-7/16 x 3/8, 1-13/16 x 3/8
CKF-9	75EF14	Size 1-3/4, 1 Pole	1-1/4 x 3/16 / 1-3/16 x 3/16
CKF-10	75FF14	Size 2, 1 Pole	1-1/2 x 3/16 / 1-3/8 x 3/8
CKF-11	75FP14	Size 2, 1 Pole	1-1/2 x 3/16 / 1-3/4 x 1/4
CKF-11A	75FP14	Size 2, Silver Contact	
CKF-12	75GF14	Size 2-1/2, 1 Pole	1-15/16 x 1/2 / 1-3/8 x 3/8
CKF-13	75GP14	Size 2-1/2, 1 Pole	1-1/2 x 5/16 / 1-3/4 x 3/8
CKF-14	75HF14	Size 3, 1 Pole	1-3/4 x 5/16 / 1 x 1/2
CKF-15	75IF14	Size 3-1/2, 1 Pole	1-7/16 x 1/2 / 1 x 1/2
CKF-16	75HF15	Size 3, 1 Pole	1-1/8 x 1/2 / 1 x 1/2
CKF-17	75JG14	Size 4, 1 Pole	1-3/4" x 5/8" / 1-1/8" x 5/8"
CKF-18	75GF15	Size G, 1 Pole	



CKF-15



CKF-16

S.E.E.S. #	O.E.M. #	Description
DCK-1	9955045	Auxiliary Contact, Furnas 49D54682NO
DCK-2	9790317	1 Pole Contact Kit, Furnas 75NB41
DCK-3	9790123	1 Pole Contact Kit, Furnas 75FE42



DCK-2



DCK-3

Contact Kits for Siemens

S.E.E.S. #	O.E.M. #	Size
CKS-01	SIE7440CK	3 Pole for Siemens 3TF44 32A
CKS-02	SIE7460CK	3 Pole for Siemens 3TF46 SIZE 2
CKS-03	SEI7470CK	3 Pole for Siemens 3TF47 SIZE 2+
CKS-04	SEI7480CK	3 Pole for Siemens 3TF48 SIZE 3
CKS-04A	3TY7500-OA	3 Pole for Siemens Fits 3TF50
CKS-05	SIE7520CK	3 Pole for Siemens 3TF52 SIZE 4
CKS-06	SIE6440CK	3 Pole for Siemens 3TB44 SIZE 1&2
CKS-07	SIE6460CK	3 Pole for Siemens 3TB46 SIZE 2
CKS-08	SIE6480CK	3 Pole for Siemens 3TB48 SIZE 3
CKS-09	SIE6500CK	3 Pole for Siemens 3TB50 150 AMP
CKS-10	SIE6520CK	3 Pole for Siemens 3TB52 200 AMP
CKS-11	3RT1936-6A, 3RT1036-A	3 Pole Siemens Size 2, 50 Amp 3RT series
CKS-12	3RT1945-6A	3 Pole Siemens 3TR1945-6A & 3TR1946-6A



CKS-03



CKS-07



CKS-11



CKS-12



Contact Kits

Contact Kits for LG Industrial Systems

S.E.E.S. #	Description
CKLG-2	3 Pole, Contact Kit for GMD/C-50
CKLG-4	3 Pole Main Contact Kit for GMD/C-75
CKLG-8	3 Pole Main Contact Kit for GMD/C-220
CKLG-10	4 Pole Main Contact Kit for GMC-22/4



CKLG-4



CKM-1



CKM-2



CKM-3



WRP-47



WRP-49

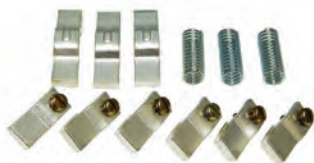

CKW-200

Contact Kits for Mitsubishi

S.E.E.S. #	O.E.M. #	Description	Movable Contact	Stationary Contact
CKM-1	BH569N300	Size 2, 3 Pole	1-1/2 x 3/16	7/8 x 5/16
CKM-1A		Size 2, 3 Pole		
CKM-2	BH559N301	Size 2-1/2, 3 Pole	1-1/2 x 3/16	1-3/16 x 1/4
CKM-3	BH569N301	Size 3, 3 Pole	1-1/2 x 3/16	7/8 x 5/16
CKM-4		Mitsubishi Size 4 S-K125		

Contact Kits for Westinghouse

S.E.E.S. #	O.E.M. #	Description
WRP-47	373B331G12, 26280602	Size 2, 3 Pole A200 MR Type J Contactor
WRP-48	626B187G13, 276A284G02	Size 3, 3 Pole A200 M4CAC Type J Contactor
WRP-49	626B187G17, 626B198G17, 26280461	Size 4, 3 Pole A200 Type J Contactor

Contact Kits for Ward Leonard

S.E.E.S. #	O.E.M. #	Description
PR-44	Kit 330	Size 3, 1 Pole
WRP-49A	811C985H06	Size 2, 1 Pole

Contact Kits

Contact Kits for General Electric

S.E.E.S. #	O.E.M. #	Description
CKGE-3	546A300G002	Size 0, 4 Pole
CKGE-4	546A300G010	Size 0, 4 Pole
CKGE-5	546A301G002	Size 1, 4 Pole
CKGE-6	546A301G053	Size 1, 4 Pole
CKGE-7	546A780G002	Size 2, 3 Pole
CKGE-8	546A780G051	Size 2, 3 Pole
CKGE-9	55153677G01	Size 3, 1 Pole
CKGE-10	55153677G002	Size 3, 3 Pole
CKGE-11	55153678G002	Size 4, 3 Pole
CKGE-12	55154607G002	Size 5, 3 Pole
CKGE-13	55754607G041	Size 5, 3 Pole
CKGE-14	GE CL05	4 Pole 30HP
CKGE-15	GE CL06	3 Pole 30HP
CKGE-16	GE CL07	3 Pole 40HP
CKGE-16A	GE CL07	4 Pole 40HP
CKGE-17	GE CL08	3 Pole 50HP
CKGE-17A	GE CL08	4 Pole 50HP
CKGE-18	GE CL09	3 Pole 60HP
CKGE-19	GE CL09	3 Pole 75HP
CKGE-20	GE CL10	3 Pole 100HP
CKGE-21	GE CR7CJ/CR7CK	3 Pole, 56-73 Amp
CKGE-22	GE CAFF2/ CA5F2CPR1	3 Pole 105 Amp



CKGE-5

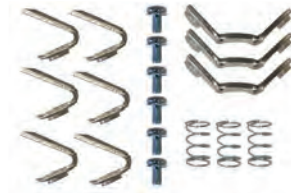

CKGE-7



CKGE-11



CKGE-15



CKGE-16A



CKGE-17



CKGE-18



CKGE-19



CKGE-20



CKGE-21

Contacts for General Elevator

S.E.E.S. #	Description
GEN-C1	Copper Contact Assembly , Contact pad 1-1/8" square, Contact Holder 3-1/4" O.L. with 12" L shunt, 1/4" mounting hole
GEN-C2	Contact Assembly , Contact blade 1-1/2" O.L. with 6" shunt and 1/2" diameter Contact Pad
GEN-C3	Metal Graphite Block , 1-1/16" x 1" with mounting hole
GEN-C4	Contact Blade , with shunt
GEN-C5	Contact , Stud 10-32 x 2-7/8" Silver Tipped for GEN-C2



GEN-C1



GEN-C2



GEN-C3



GEN-C4

S.E.E.S. #	Description	Type
CKARO-1	Contact Kit, 1+	35
CKARO-2	Contact Kit, 2	50
CKARO-3	Contact Kit, 2+	65
CKARO-4	Contact Kit, 3	80
CKARO-5	Contact Kit, 3+	85
CKARO-6	Contact Kit 4+	190



CKARO-1



JC-3A

Contact Kits for Joslyn Clark

S.E.E.S. #	O.E.M. #	Description
JC-3A	KTM31-1	Size 00-0-1, 3 Pole
JC-3	KTM32-1	Size 2 Starter
JC-4	KTM33-1	Size 3 Starter



Brushes

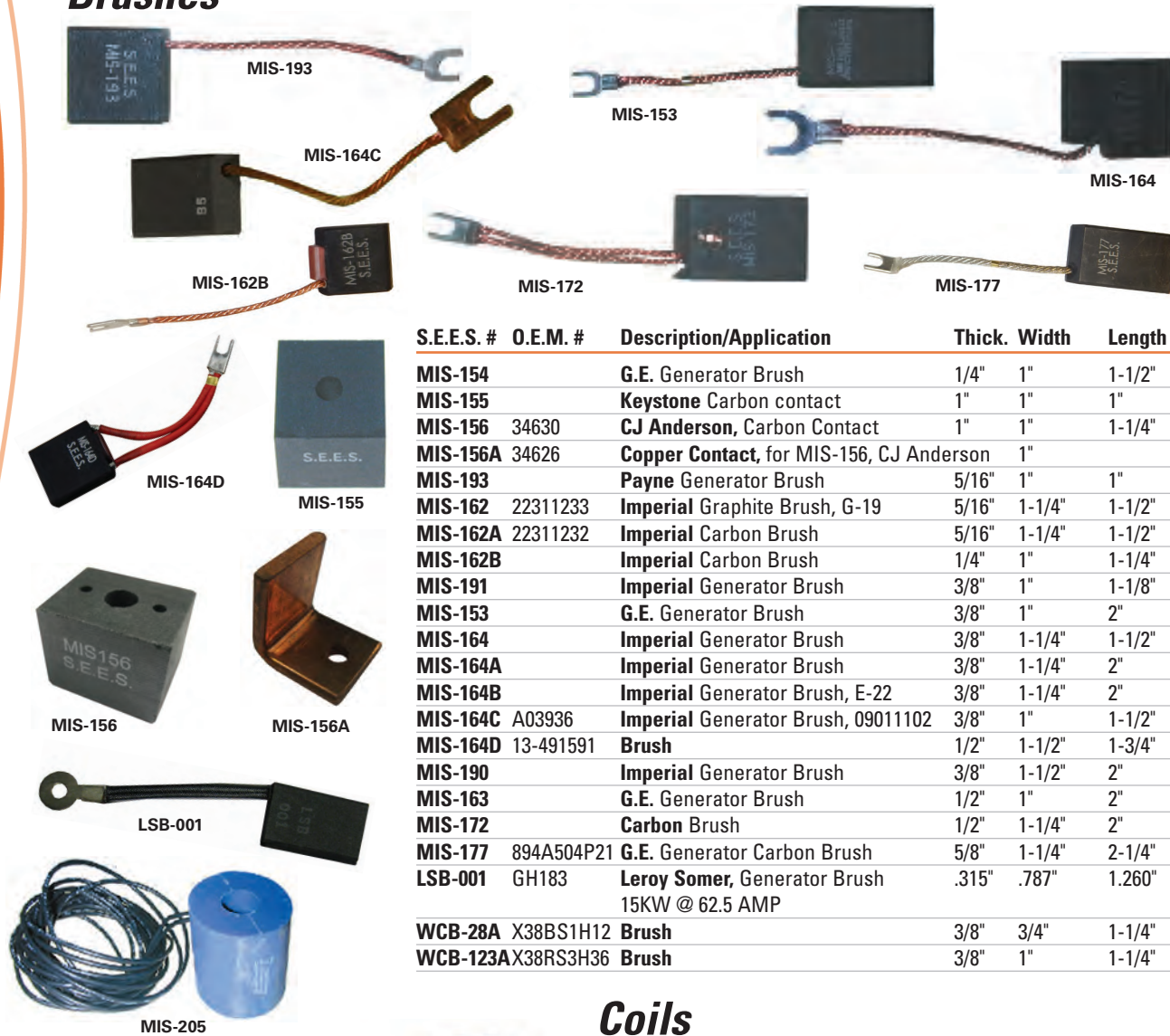

S.E.E.S. #	O.E.M. #	Description/Application	Thick.	Width	Length
MIS-154		G.E. Generator Brush	1/4"	1"	1-1/2"
MIS-155		Keystone Carbon contact	1"	1"	1"
MIS-156	34630	CJ Anderson, Carbon Contact	1"	1"	1-1/4"
MIS-156A	34626	Copper Contact, for MIS-156, CJ Anderson	1"		
MIS-193		Payne Generator Brush	5/16"	1"	1"
MIS-162	22311233	Imperial Graphite Brush, G-19	5/16"	1-1/4"	1-1/2"
MIS-162A	22311232	Imperial Carbon Brush	5/16"	1-1/4"	1-1/2"
MIS-162B		Imperial Carbon Brush	1/4"	1"	1-1/4"
MIS-191		Imperial Generator Brush	3/8"	1"	1-1/8"
MIS-153		G.E. Generator Brush	3/8"	1"	2"
MIS-164		Imperial Generator Brush	3/8"	1-1/4"	1-1/2"
MIS-164A		Imperial Generator Brush	3/8"	1-1/4"	2"
MIS-164B		Imperial Generator Brush, E-22	3/8"	1-1/4"	2"
MIS-164C	A03936	Imperial Generator Brush, 09011102	3/8"	1"	1-1/2"
MIS-164D	13-491591	Brush	1/2"	1-1/2"	1-3/4"
MIS-190		Imperial Generator Brush	3/8"	1-1/2"	2"
MIS-163		G.E. Generator Brush	1/2"	1"	2"
MIS-172		Carbon Brush	1/2"	1-1/4"	2"
MIS-177	894A504P21	G.E. Generator Carbon Brush	5/8"	1-1/4"	2-1/4"
LSB-001	GH183	Leroy Somer, Generator Brush 15KW @ 62.5 AMP	.315"	.787"	1.260"
WCB-28A	X38BS1H12	Brush	3/8"	3/4"	1-1/4"
WCB-123A	X38RS3H36	Brush	3/8"	1"	1-1/4"

Coils



S.E.E.S.#	O.E.M. #	Description
MIS-205	S-651	EECO Coil, 110 VAC, UV7
MIS-205A	S-652	EECO Coil, 208 VAC, UV7
MIS-205B	S-653	EECO Coil, 220 VAC, UV7
MIS-205C	S-752	EECO Coil, 110 VDC, UV7
MIS-205D	S-753	EECO Coil, 220 VDC, UV7
MIS-205F	S-463	EECO Coil, 230 VAC, UV5
MIS-205G	S-461	EECO Coil, 110 VAC, kit of 4 for UV5
MIS-212	208200	Maxton Coil, Red, 110 VAC
MIS-213	208100	Maxton Coil, Black, 115 VDC
MIS-213A	208300	Maxton Coil, 12 VDC Black # N-3042
MIS-214	208000	Maxton Coil, Green, 208/ 220/ 240 VAC
MOC-1	C-3, 1009768	Monarch Coil, 9K Ohms
MOC-3	C-7, CR6053-7	Monarch Coil, 1,680 Ohms
MOC-4	C-9	Monarch Coil, 650 Ohms
MOC-5	C-13, 1-00-9798	Monarch Coil, 2,420 Ohms
WTC-01	TA-4310	Watson Coil, 3500 Ohms

Printed Circuit Boards

Elevator Control Boards

S.E.E.S. #	O.E.M. #	Description
WIPC-001	24870	PC Board, Low Oil and Door Timer Board 24V, Wiggers
LPCB-22	DHL-270	PC Board, LG, # DOR-270
LPCB-38A	DOR-200	PC Board, LG, # DOR-200
LPCB-39	DOR-231	PC Board, LG-Otis, # DOR-231
LPCB-86	DCL-243	PC Board, LG Sigma Elevator Main board
LPCB-145	DOR-220	PC Board, LG, # DOR-220

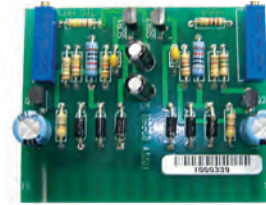

WIPC-001



LPCB-145



LPCB-22

Rectifiers



MIS-203



MIS-204



MIS-204C

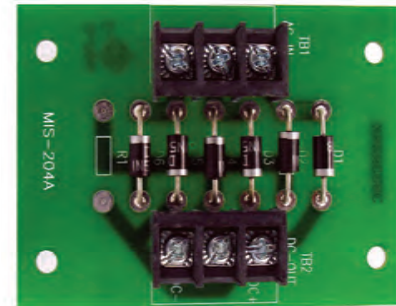

MIS-204A



MIS-204B



MIS-204D



MIS-204E

S.E.E.S. #	Description
MIS-203	Rectifier, Single phase, 5-6 amps, plug in silicon, tube type base (Payne K7822)
MIS-203A	Rectifier, 3 phase 8 pin octal plug
MIS-204	Rectifier, 8 amp, silicon bridge "candy bar" rectifier
MIS-204A	Rectifier, 3 Phase, PC Board replacement for MIS-204
MIS-204B	Rectifier, 600V-1000V, 35 amp, Single Phase
MIS-204C	Rectifier, Omniphase 400V, 6 amp
MIS-204D	Rectifier, 3 Phase, 600V, 27.5 amp

S.E.E.S. #	O.E.M. #	Description
MIS-204E	PSD95/12	Rectifier, 140 AMP/1200 VAC max 3 PH bridge
MIS-204EA	Z575LA80A CKE	Surge Suppressor, for MIS-204E
MIS-204F	PSD25/12	Rectifier, 3 Phase, 1200V, 25 amp



MIS-204EA



Relay Testers



MIS-301UT



Includes Case



MIS-301UT1

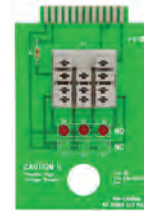

MIS-301UT2



MIS-301UT3

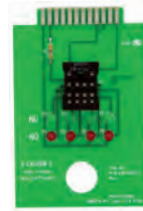

MIS-301UT4

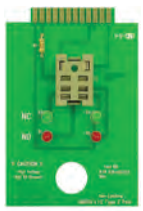

MIS-301UT5



MIS-301UT6



MIS-301UT7



MIS-301UT8



MIS-301UTF-C
MIS-301UTF



MIS-300T



MIS-301T

Universal Multi-Volt Relay Tester

S.E.E.S. #	O.E.M. #	Description
MIS-301UTK		Tester Kit , Universal multi-volt relay tester with lamp test fixture and carrying case. Tests 2-12 pole relays including the following: P&B R1 relays, KU Series 2 and 3 pole relays, Omron MY/LY relays, Haughton 6 pole relays, IBM relays, Input Output modules. ■ Includes boards MIS-301UT1 thru MIS-301UT13
MIS-301UT		Relay Tester , universal, with case, AC/DC V boards sold separately or in a kit
MIS-301UT1	936-003702	Relay , P&B R1- series
MIS-301UT2	936-003703	Relay , KU series 2/3 pole
MIS-301UT3	N2878B	Board , lamp test
MIS-301UT4	936-003712	Relay , Omron MY type, 2/4 pole
MIS-301UT5	936-003713	Relay , Omron LY type, 2 pole
MIS-301UT6	936-003714	Relay , HRP-4BB/4BA
MIS-301UT7	936-003730	Relay , IBM 4-12PDT, 45 VDC
MIS-301UT8	936-003731	Relay , solid state, plug in
MIS-301UT9		Relay Test Board , Card insert I/O module relays
MIS-301UT10		Relay Test Board , I/O module for DRP-22H, DRP-22C, DRP-22F
MIS-301UT11		Relay Test Board , I/O module for DRP-22B & DRP-22G
MIS-301UT12		Relay Test Board , LY4N relay tester
MIS-301UT13		Test Board , Motion Control 100 VDC Safety Relay
MIS-301UT14		Test Board , for PR-36, 37 & PR-52 Guardian type relays
MIS-301UTF		Main Fuse , SEES relay tester 500MA
MIS-301UTF-C		Coil Fuse , SEES relay tester 250MA
MIS-301UT-IBM		IBM Tester kit , MIS-301UT with IBM test card



MIS-301UT10

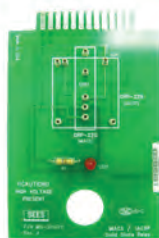

MIS-301UT11



MIS-301UT12



MIS-301UT13

Specialty Relay Testers

S.E.E.S. #	O.E.M. #	Description
MIS-300T		Relay tester . Hall effect, non contact LED relay tester. Ideal for "ice cube" relays. Works with all voltages and currents.
MIS-301T		Universal Relay Tester . For IBM style relays.
MIS-310		EEPROM Memory Copier
MIS-311		EEPROM Eraser with Timer
MIS-312	A835RPLBOX	PCB, EDR assembly with box

Relays

4 Pole Plug-in "Ice Cube" Relays

S.E.E.S. #	O.E.M. #	Description
PR-11	156-14-T200, KHU17A12-120	120 VAC, 4 PDT, Dust Cover
PR-11B	156-14-V100	240 VAC, 4 PDT, Dust Cover with Pushbutton & Light
PR-12	156-14-T2LC	120 VAC, 4 PDT, Dust Cover with Pushbutton & Light
PR-12A	KHAU17A12N-120	120 VAC, 4 PDT, Dust Cover with Light
PR-12B	156-24-P2LC	12 VAC, 4 PDT, Dust Cover with Pushbutton & Light
PR-25	156-14-F200, KHU17D12-110	110 VDC, 4 PDT, Dust Cover with Pushbutton
PR-25A	156-14-F2LC	110 VDC, 4 PDT, Dust Cover with Pushbutton & Light
PR-25B		110 VDC, 4 PDT, Bifurcated with LED
PR-25C		110 VAC, 4 PDT, Bifurcated with LED
PR-25D		24 VDC, 4 PDT, Bifurcated with LED
PR-63	156-14-B200, KHU17D12-12	12 VDC, 4 PDT, Dust Cover
PR-63A		12 VDC, 4 PDT, Bifurcated, Push-Test
PR-64A	156-14-D200, KHU17D12-48	48 VDC, 4 PDT, Dust Cover
PR-64B	156-14-D2LC	48 VDC, 4 PDT, Dust Cover with Pushbutton & Light
PR-64C		48 VDC, 4 PDT, 5A with Light
PR-65	156-14-C200, KHU17D12-24	24 VDC, 4 PDT, Dust Cover with LED
PR-65B		24 VDC, 4 PDT, Bifurcated
PR-66	156-14-Q200, KHU17A12-24	24 VAC, 4 PDT, Dust Cover
PR-66A	156-14-Q2LC	24 VAC, 4 PDT, Dust Cover with Pushbutton & Light

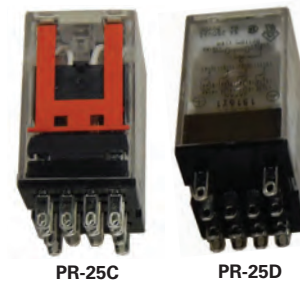

PR-25C

PR-25D

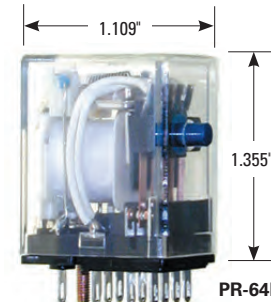

PR-64B

■ Use Sockets PR-86, PR-89

PR-26 Dimensions

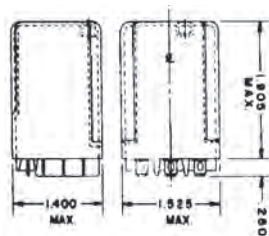

Plug-in Relays with Dust Cover

S.E.E.S. #	O.E.M. #	Description
PR-53A	157-23-N200, KUP-14A15-6	6 VAC, 3 PDT
PR-53	157-23-P200, KUP-14A15-12	12 VAC, 3 PDT
PR-67	157-22-B200, KUP-11D15-12	12 VDC, 2 PDT
PR-72	157-23-Q200, KUP-14A15-24	24 VAC, 3 PDT
PR-26	KUP-14D15	24 VDC, 3 PDT
PR-68	157-22-C200, KUP-11D15-24	24 VDC, 2 PDT
PR-71	157-23-C200, KUP-14D15-24	24 VDC, 3 PDT with Pushbutton & Light
PR-22	157-23-D2LC	48 VDC, 3 PDT with Pushbutton & Light
PR-24	157-23-D200, KUP-14D15-48	48 VDC, 3 PDT
PR-69A	KUL-11D15D-110	110 VDC, 2 PDT, latching type, 10 Amp
PR-21	157-23-F2LC	110 VDC, 3 PDT with Pushbutton & Light
PR-23	157-23-F200, KUP-14D15-110	110 VDC, 3 PDT
PR-24A	157-23-F2C0,	110 VDC, 3 PDT with Pushbutton
PR-24B	KUP14D35-110 V	110 VDC, 3 PDT with Light
PR-70	157-22-T200, KUP-11A15-120	120 VAC, 2 PDT
PR-70A	47354	120 VAC, 2PDT, 10 Amp
PR-14	157-23-T200, KUP-14A15-120	120 VAC, 3 PDT
PR-15	157-23-T2LC	120 VAC, 3 PDT with Pushbutton & Light
PR-16	157-23-U2C0	240 VAC, 3 PDT with Pushbutton
PR-17	157-23-U200, KUP-14A15-240	240 VAC, 3 PDT
PR-17A	KUP14A35-240 V	240 VAC, 3 PDT with Light
PR-18	157-23-U2LC	240 VAC, 3 PDT with Pushbutton & Light
PR-39	157-22-U200, KUP-11A15-240	240 VAC, 2 PDT

■ Use Sockets PR-92 thru PR-94 and PR-33



PR-26

PR-24

PR-64C



PR-21

PR-23

PR-70

■ Transparent Orange Lexan Dust Cover offers Environmental Protection

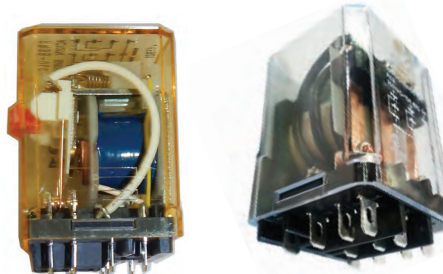

PR-15

PR-16



Relays

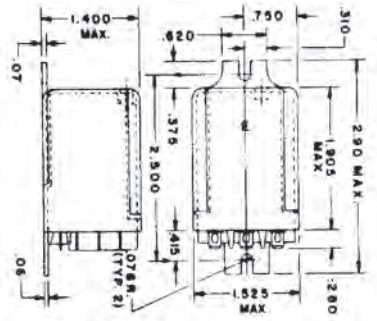

PR-38

Plug-in Relay with Flanged Dust Cover

S.E.E.S. #	O.E.M. #	Description
PR-38	157-33-D200, KUP-14D55-12	48 VDC, 3 PDT
PR-95A	MJN-2CE-DC48	48 VDC, 2 PDT
PR-73	157-33-T200, KUP-14A55-120	120 VAC, 3 PDT

■ Transparent Green Lexan Dust Cover with Mounting Flanges allows for surface mounting.



PR-74



PR-95A

General Purpose Industrial Plug-in Relays 10 Amp

S.E.E.S. #	O.E.M. #	Description
PR-74	158-12-B200	12 VDC 2 PDT Dust Cover
PR-75	158-12-C200	24 VDC 2 PDT Dust Cover
PR-95A	MJN-2CE-DC48	48 VDC 2 PDT Flange mount
PR-11A	158-12-T2CO	120 VAC 2 PDT Dust Cover with Pushbutton

■ Use Sockets PR-86 thru PR-89, Transparent green polycarbonate dust cover offers environmental protection.

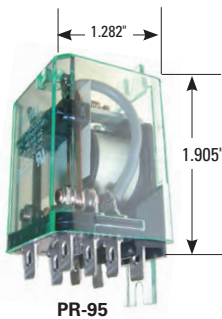

PR-95



PR-96

Plug-in 20 Amp Power Relay with Flanged Dust Cover

S.E.E.S. #	O.E.M. #	Description
PR-95	187-32-C200, 20607-82	24 VDC 2 PDT Flanged Dust Cover
PR-96	187-32-T200, 20601-84	120 VAC 2 PDT Flanged Dust Cover



PR-77



PR-78A

Miniature DPDT "Dipper" Relay

S.E.E.S. #	O.E.M. #	Description
PR-77	190-22-B100, HAS112S-12V	12 VDC DPDT 2 Amp .827" L x .436"
PR-77A	RP010012 OBS	Relay, SPST 12 VDC 10A PCB Socket Mgt for IP8300 Selector
PR-78	190-22-C100, T82P11D113-24D	24 VDC DPDT 2 Amp
PR-78A	RT1314024F	Relay, Dipper 24 VDC 16A 2P2T for GPC-003 pcb
PR-78B	G5RL-1-E_AC_115/120	Relay, PCB, SPDT 16A, 115/120 AC Coil
PR-78C	G6E-134P-ST-US-DC12	Relay, 12 VDC SPDT
PR-79	190-22-E100	5 VDC DPDT 2 Amp
PR-82	310-11-B200	12 VDC SPDT



PR-78B



PR-106

4PDT Plug-in Relay

S.E.E.S. #	O.E.M. #	Description
PR-106	LY4N-AC110/120	Relay, 120 VAC 10 Amp, 4 PDT
PR-106A	LY4N-DC110/100	Relay, 4 Pole 110 VDC with LED 10 Amp
PR-106B	LY4N-AC200/220	Relay, 4 Pole 220 VAC 10 Amp
PR-106S	SH48-DC24	Socket, surface mount relay
PR-114	LY4N-DC24	Relay, 4 PDT, 24 VDC



PR-78C

Relays

General Purpose 10 Amp "Guardian" Type Plug-in Relays

S.E.E.S. #	O.E.M. #	Description
PR-37	A410-361362-00	240 VAC 3 PDT, alternate is PR-36B & PR-17
PR-40	IR-640U-4C-120A	120 VAC 4 PDT
PR-52	IR-1225-3C-110D	110 VDC 3 PDT, alternate is PR-36B & PR-23
PR-52A	IR-1225-2C-110D	110 VDC 2 PDT
PR-52-KIT	11340-01 Alt	Guardian Kit Replacement , 3 PDT 110 VDC
PR-36	IR-1220-3C, A410-361344-00	120 VAC 3 PDT, alternate is PR-36B & PR-14
PR-36A	1220-SOC-2	Base , Panel Mount, for 3P relays, PR-36, 37 & 52
PR-36B		Socket adaptor . This adaptor enables the use of KUP style 3 pole relays to replace the Guardian style. Plugs directly into the original Guardian relay socket. (Relay not included)
PR-36L		Relay , 3 PDT, 120 VAC AHTR



S.E.E.S. #	O.E.M. #	Description
PR-115	56.OA022442N	Force guided safety relay , 4 N.O. & 2 N.C. 24 VDC
PR-116	G2R-1-S-AC1205	Relay , SPDT 120 VAC Plug In Used On EECO TS-1000 Tape Read
PR-119	895-1215, LY3DC24	Relay , 3 PDT 10A 24 VDC Power Relay for ECI door operator
PR-103S	HG4-SF	Relay Socket Kit , surface mount for 4P relay
DRP-36	9787769, 690BX5	Relay , Subminiature PCB, 24V, G6B SPST 5A

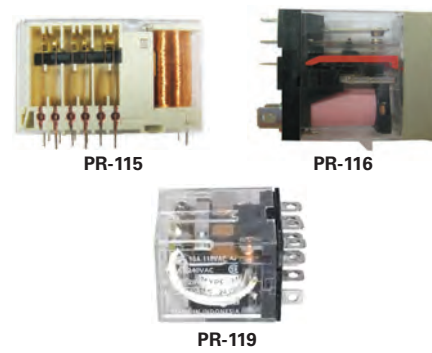

Joslyn Clark Relays

S.E.E.S. #	O.E.M. #	Description
JC-9A	PLR240A	Phase Monitor , 197-240V, Octal plug-in
JC-9-KIT	PLR240A	Phase Monitor Kit , 197-240V, NDS-8 Socket
JC-10A	PLR480A	Phase Monitor Assembly 440-480V, Octal plug-in
JC-10-KIT	PLR480A	Phase Monitor Kit , 440V + Socket

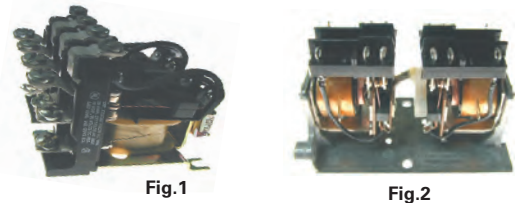

Sockets for Relays

* see more sockets on page 289.

"P & B" Relays

Fig.	S.E.E.S. #	O.E.M. #	Description
1	PR-54	PM-17DY	Relay , 110 VDC 4 PDT
1	PR-55	PM-17AY	Relay , 120 VAC 4 PDT
1	PR-56	PM-17AY	Relay , 240 VAC 4 PDT
2	PR-41	KB-17AG	Relay , 120 VAC 4 PDT, Latching Relay
2	PR-42	RL014A240	Relay , 240 VAC 4 PDT, Latching Relay
2	PR-43A		Relay , Latching 4 Pole 120 VAC Plug In, Din or Surface Mounting
2	PR-69A	KUL-11D15D-110	Relay , Plug-In 2PDT 110 VDC Latching Type 10amp

S.E.E.S. #	O.E.M. #	Description
PR-121	VP-2030	EC relay kit





Relays



PR-98B



PR-18A



PR-18B

PR-98



PR-98A

RT7-E1



WT-01

PR-30

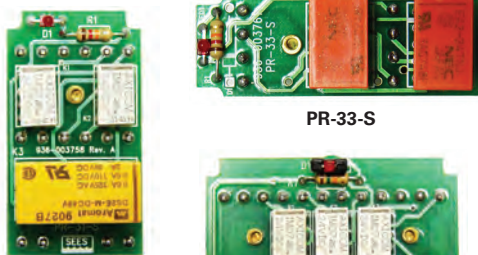

PR-31-S

PR-33-S

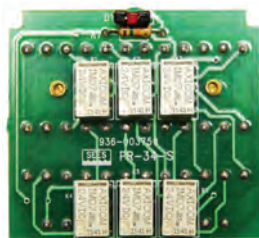

PR-34-S

Trip Counter

S.E.E.S. # O.E.M. # Description

PR-98B H 7EC-N-B Universal Electrical Trip Counter 8 digit ICD read out with battery

"Time Delay" Relays / Timers

S.E.E.S. # O.E.M. # Description

PR-83	613-12-T400	120 VAC 1-120 sec.	External Resistor used with socket PR-32
PR-18A	614-43-T400, CLB-51-70120	120 VAC 1.2-120 sec.	Knob Adjustment used with socket PR-32
PR-18B	614-43-T100, CLB-51-70010	120 VAC .1-10 sec.	Knob Adjustment used with socket PR-32
PR-19D	614-43-F400	110 VDC 1.2 - 120 sec.	Knob Adjustment used with socket PR-32
PR-19E	614-43-U400	240 VAC 1.2 - 120 sec.	Knob Adjustment used with socket PR-32
PR-19G	655-12-F600	110 VDC 3 - 300 sec.	Solder 5 amp. used with socket PR-89
PR-19B	655-13-T300	120 VAC 0.6 -60 sec.	Solder 10 amp.
PR-98	438-USA	24-240 VAC/VDC	1 - 512 sec. Adjustable Universal Timer Delay-On Operate Timer
PR-98A		12/240 VAC/DC SPDT	Timer, Univ Adj .1 sec- 20hr on/off delay, compatible with 3" 35mm din rail mgt kit (MIS-004)
RT7-E1		5A @ 250 VAC 4A @ 24 VDC	Relay, Thermistor
RZ7-FSA3-FU23			Timer, On Delay, SPDT, 15-180, 24-48D
WT-01	X45GS1H59	X120 VAC .1 - 102 sec.	Plug in Timer, .1-102 Sec Adj 120 VAC (11 pin round)

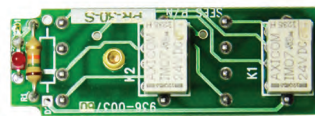

PR-30-S

IBM Relays

S.E.E.S. # O.E.M. # Description

PR-28S			Solid State Replacement for PR-28
PR-30	9767540		Relay, 48 VDC, 4 PDT
PR-30S			Relay, 48 VDC, 4 PDT W/LED solid state, alternate to PR-30
PR-30-S	769489		Relay, Solid State IBM 4 Pole 48 VDC, economy, SEES Smart Buy
PR-31S			Solid State Replacement for PR-31
PR-31-S	769019		Relay, Solid State IBM 6 Pole 48 VDC, economy, SEES Smart Buy
PR-33	186685		Relay, 45 VDC 4 PDT Latching Relay
PR-33S			Solid State Replacement for PR-33
PR-33-S	186685		Relay, Solid State IBM 4 Pole Latching relay, 48 VDC, economy
PR-34-S	769488		Relay, Solid State IBM 12 Pole, economy, SEES Smart Buy

Relays

IBM Relays

S.E.E.S. #	O.E.M. #	Description
PR-28-BC	9710322	Clip, bottom hold down clip for relay
PR-28-TC	9710310	Clip, top hold down clip for relay
PR-35	159941	Base for 4 Pole Relays
PR-35C	159942	Base for 6 PDT Relays
PR-35E	136267	Arc Suppressor Assy, Diode 3A, 50V for PR-35
PR-35D	159943	Base for 12 PDT Relays
PR-35A		Contact Wires
PR-35B		Taper Pins for base wiring
PR-35L6		Jumper, 6" insulated wire with taper pin
PR-35L10		Jumper, 10" insulated wire with taper pin
PR-35L18		Jumper, 18" insulated wire with taper pin
PR-35L24		Jumper, 24" insulated wire with taper pin
PR-35L30		Jumper, 30" insulated wire with taper pin
PR-35R		Relay Base Kit, Base, Top/Bottom Clip Hardware and Diode
PR-35T		Tool, IBM contact removal and insertion tool
PR-35T		Tool, IBM contact removal and insertion tool
PR-36-KIT		Guardian Relay Replacement Kit, 3 PDT 120 VAC
PR-37-KIT		Guardian Relay Replacement Kit, 3 PDT 240 VAC



No. of Contact	A	B
4 PDT	2"	5/8"
4 PDT (long yoke)	2"	5/8"
6 PDT	2"	15/16"
12 PDT	2"	1-7/8"
4 PDT Latch	2"	5/8"
6 PDT Latch	2"	15/16"

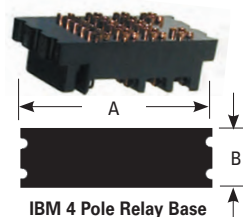

Relay Dimensions listed for Identification Assistance

IBM Relays

S.E.E.S. #	Description
SEES-IBMS-001L	SEES IBM Socket Adaptor, L.H. 4P IBM to Ice Cube Adaptor
SEES-IBMS-001R	SEES IBM Socket Adaptor, R.H. 4P IBM to Ice Cube Adaptor
SEES-IBMS-001L-D	SEES IBM Socket Adaptor, L.H. with Diode, IBM to Ice Cube Adaptor
SEES-IBMS-001R-D	SEES IBM Socket Adaptor, R.H. with Diode, IBM to Ice Cube Adaptor
SEES-IBMS-002L	SEES IBM Socket & Relay, L.H. 4 PDT 48 VDC 5A
SEES-IBMS-002L-D	SEES IBM Socket & Relay, L.H. with Diode, 4 PDT 48 VDC 5A
SEES-IBMS-002R	SEES IBM Socket & Relay, R.H. 4 PDT 48 VDC 5A
SEES-IBMS-002R-D	SEES IBM Socket & Relay, R.H. with Diode, 4 PDT 48 VDC 5A
SEES-IBMS-003R	SEES IBM Socket & Relay, R.H. 4 PDT 48 VDC 5A, Push TT & LED



Relays



PR-27

Octal Base Power Relays

S.E.E.S. #	O.E.M. #	Description
PR-27	KRP-11DG	110 VDC DPDT, 8 pins
PR-57	155-92-B200	12 VDC DPDT, 8 pins
PR-59	155-92-Q200	24 VAC DPDT, 8 pins
PR-60	155-92-T200	120 VAC DPDT, 8 pins
PR-61	155-93-C200	24 VDC 3 PDT, 11 pins
PR-62	155-93-T200	120 VAC 3 PDT, 11 pins
PR-59A	MK2PN-S-AC240	240 VAC 2 PDT 8 pins
PR-117	MK2P-1 240 VAC	240 VAC, 2 PDT, 8 pin round
PR-118	MK32P-5-1 240 VAC	240 VAC, 3 PDT 11 pin round
PR-118A	R15-2013-23-5120-WTL	Relay, 3 PDT 11 Pin Octal, 120 VAC



PR-57



PR-117



PR-61



PR-118

SPST / SPDT Power Relay

S.E.E.S. #	Description
PR-116	Relay, SPDT 120 VAC Plug In Used On EECO TS-1000 Tape Read

DPST 30 Amp Power Relay

S.E.E.S. #	O.E.M. #	Description
DRP-16	PR3280	6 VDC DPST with Magnetic Blow-Out
PR-1A	PRD7AY0-12VDC, W199X7	12 VDC DPST N/O
DRP-11	W199X8	24 VDC DPST N/O
DRP-7	76901, PR80033, 199BX17	48 VDC DPST with Magnetic Blow-Out
DRP-8	76902, PRD7DY0	48 VDC DPST N/O
DRP-12A	72014, PR3975, PRD7DHO	110 VDC DPST with Magnetic Blow-Out
PR-101	PR3972, W199X9	110 VDC DPST N/O
DRP-14A	71924, PR3723, PR3973, PRD7AHO-120	120 VAC DPST with Magnetic Blow-Out
PR-9A	PRD-7AY0	240 VAC DPST
PR-10A	PRD7AHO	240 VAC DPST, with Magnetic Blow-out

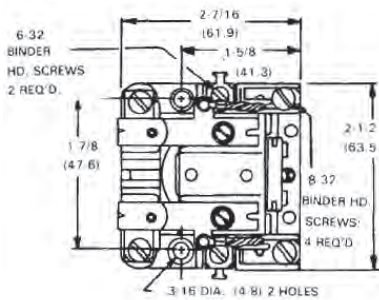

DRP-16

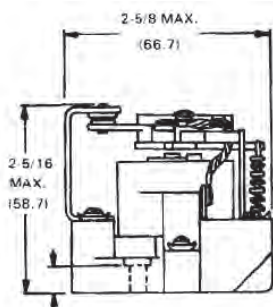

DRP-11

Relays

DPDT 30 Amp Power Relays

S.E.E.S. #	O.E.M. #	Description
PR-9	302.11U100, PRD11400, W199AX15	240 VAC DPDT
PR-10	302-11U1M0	240 VAC DPDT with Magnetic Blow-Out
PR-7	302-11T100, PRD11AY0	120 VAC DPDT
PR-8	302-11T1M0, PRD11AHO, W199ABX14	120 VAC DPDT with Magnetic Blow-Out
PR-3	30211F100, W199X14	110 VDC DPDT
PR-4	30211F1M0, PRD11YDHO, W199BX14	110 VDC DPDT with Magnetic Blow-Out
PR-6	30211Q100, PRD11AY0, W199AX13	24 VAC DPDT
PR-5	30211P100	12 VAC DPDT
PR-1	W199X12	12 VDC DPDT
DRP-13	PRD11DHO-12	12 VDC DPDT with Magnetic Blow-Out
PR-2	30211C100, W199X13	24 VDC DPDT
DRP-5A	PRD11DHO	48 VDC DPDT with Magnetic Blow-Out
DRP-2	PRD11YDO, 199X18	48 VDC DPDT



PR-7



PR-1



DRP-5A



PR-86



PR-87



PR-88



PR-89

Sockets for "Ice Cube" Plug-In Relays & Timers

S.E.E.S. #	O.E.M. #	Description
PR-86	670-0002, S156-4SL10, S158-25L10	4 Pole, Solder Lug, .125 Short Terminal, .187 Solder Ground Lug
PR-87	670-0003, S156-4PC10, S158-2PC10	4 Pole, .200 Printed Circuit Terminal, .187 Solder Type Ground Lug
PR-88	670-0014, S156-4PC00, S1582PC00	4 Pole, .200 Printed Circuit Terminal, No Ground Lug
PR-89	670-01204	Pole, Surface Mount, screw terminal socket with closed back construction. The front mounted 6-32 screw terminals will accept wires up to 14 AWG.

Sockets for Plug-In Relays & Timers

S.E.E.S. #	O.E.M. #	Description
PR-90	670-0126	10 Amp, 11 Pin Octal, Screw Base
PR-91	670-0127	10 Amp, 8 Pin Octal, Screw Base
PR-92	670-0009	3 Pole, 300 VAC, Solder Lug Terminal
PR-93	670-0012	3 Pole, 3/16" Quick Connect Terminal, PC Terminal
PR-32	670-0125	3 Pole, Screw Terminal Base, 15 Amp, The front mounted 6-32 screw terminals will accept wires up to 14 AWG.
PR-32A	9952007	Relay Socket, DIN Rail Mount, Screw Terminals
PR-94	670-0013	3 Pole, PC Terminal with Mounting Ears, 15 Amp



PR-90



PR-91



PR-32



PR-94



PR-92



PR-93

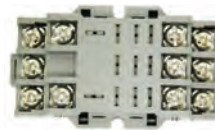

PR-32A



Relays



PR-102SS

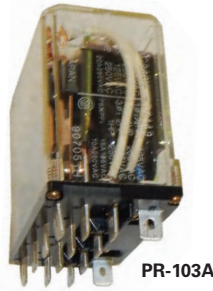

PR-103A



PR-103S



PR-103SS



PR-104



PR-120



PR-130



ORP-45

S.E.E.S. #	O.E.M. #	Description
PR-102SS	HG2-SS	Socket, solder terminal for DP relay
PR-103A	HG4-AC240	Relay, 4 PDT 20 Amp, 240 VAC
PR-103B	HG4-DC110	Relay, 4 PDT 20 Amp, 110 VDC
PR-103S	HG4-SF	Socket, surface mount for 4P relay
PR-103SS	HG4-SS	Socket, solder terminal for 4P relay
PR-103S-A		Relay Socket, 2 Pole DIN Mounting, Screw Terminals
PR-104	HC4-H-AC115V	Relay, 4 PDT, 5 Amp, 115 VAC
PR-104A	HC4-H-AC240V	Relay, 4 PDT, 5 Amp, 240 VAC
PR-104B	HC4-H-DC110V	Relay, 4 PDT, 5 Amp, 110 VDC
PR-114	9953723, LY4N-DC24	Relay, 4 PDT, 24 VDC
PR-120	9783398, LY2-DC24	Relay, 2 PDT 24 VDC 15 AMP
PR-130	AAA638AE6	Relay, 280A
ORP-45	VC15-2A2B-AC	Relay, 120 VAC, 2 N.O. & 2 N.C.
ORP-45A	VC15-3A1B-AC	Relay, 120 VAC, 3 N.O. & 1 N.C.
ORP-45B	VC15-4A-AC	Relay, 120 VAC, 4 N.O.

Switches



GLS-001



GLS-004



MIS-181



MIS-181B



MIS-181B-A

Magnetic and Limit Switches

S.E.E.S. #	O.E.M. #	Description
GLS-001	SW16-0001N	Switch, LD Limit, 2 N.C. Contacts
GLS-002	SW5-0020N	Switch, "LSO" Limit, 1 N.O. Contact
GLS-003	SW4-0002N	Switch, "LTD" Limit, 1 NO/1NC Contact
GLS-004	SW4-0001N	Switch, "LTS" Limit, 1 N.O. Contact
GLS-005	SW5-0003N	Switch, "LS" Limit, 1 N.C. Contact, Manual Reset
MCE-003	SND4118-SL-A	Limit Switch, 1 N.O. / 1 N.C. with Roller
MIS-181	MV-4C	Magnetic Leveling Switch, 1 N.C., 1 N.O.
MIS-181B	LS-1, LS-1B	Limit Switch with Roller, 1 N.O., 1 N.C.
MIS-181B-A		Roller, Replacement for MIS-181B switch
MIS-181C	MV-4D, 2569AD	Magnetic Leveling Switch Double unit, (replaces MV-3 switch) 230 VDC-330 VAC, 2 N.O. 2N.C.
MIS-181E		Prox Leveling Sensor, 90-250 ANC L.H. Side Sensing, 2 Wire

Switches

Magnetic and Limit Switches

S.E.E.S. #	O.E.M. #	Description
MIS-181F		Limit Switch, Universal 2 N.C. Contacts 1.97" diameter Roller
MIS-181G	D4C-1620	Limit Switch, SPDT, Snap Act Self Reset, 5A 250 VAC
MIS-181J	534-351	Limit Switch, 534-351 600V 10A NEMA 4/12
MIS-181K		Limit Switch, Water Tight
MIS-181L		Limit Switch, N.C. Contact
MIS-184A	PMR-1	Magnetic Switch, 1 N.O., 1 N.C. 250 WATT rating to 120VAC/DC
MIS-184B		Magnetic Leveling Switch, SPDT 1A 250 VDC, 18" flying leads
MIS-202A	852050003	Replacement Roller, 1-1/2" O.D. 5/16" thick, 1/4" I.D. for General Elevator Limit Switch GLS-1
MCE-003		Limit Switch, 1 NO / 1 NC with Roller
SJSW-1		Autonics Inductive Proximity Sensor





Contactors and Thermal Overload Relays



Contactors

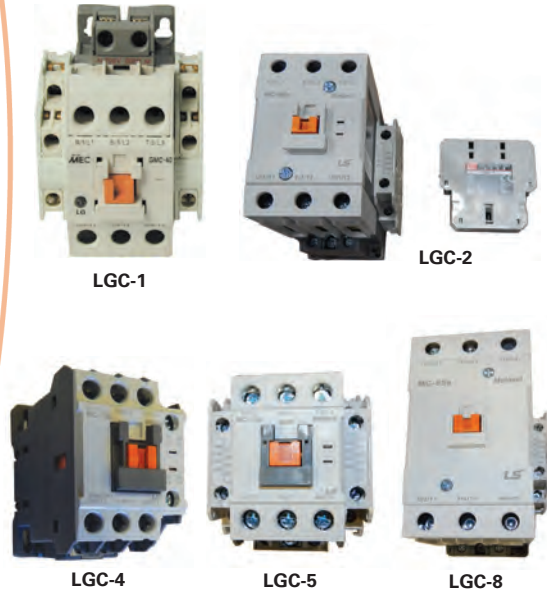

S.E.E.S. #	O.E.M. #	Description
LGC-1		Contactor , 10 HP 230 VAC coil, 40 AMP
LGC-2		Contactor , 20 HP 230 VAC coil, 65 AMP
LGC-3		Contactor , 30 HP 230 VAC coil, 85 AMP
LGC-4	GMC-18-120 VAC	Contactor , 3 HP, 120 VAC coil, 18 AMP
LGC-5	GMC-32-120 VAC	Contactor , 7.5 HP, 120 VAC coil, 32 AMP
LGC-6		Contactor , 10 HP, 120 VAC coil, 40 AMP
LGC-7	GMC-65-120 VAC	Contactor , 20 HP, 120 VAC coil, 65 AMP
LGC-8		Contactor , 30 HP, 120 VAC coil, 85 AMP
LGC-9		Contactor , 40 HP, 110/120 VAC coil, 125 AMP
LGC-10		Contactor , 60 HP, 100/240 VAC coil, 100 AMP
LGC-11		Contactor , 50/100 HP, 100 VAC, #4, 150 AMP
LGC-13		Contactor , 75/150 HP, 100-240 VAC, #4++, 220AMP
LGC-15		Contactor Relay , 4Pole NC 220 VDC, 16 AMP
LGRC-01	GMC-22R-120 VAC	Contactor , Reversing 22A 120 VAC
PR-113	GMC-18R-208 VAC	Contactor , Reversing, 18A, 208 VAC
LGRS-12	9778433	Contactor , Reversing, 22A, 48 VDC, for door operator



DC Contactors

S.E.E.S. #	O.E.M. #	Description
LGD-1	GMD-12-220 VDC COIL	DC Contactor , 20 AMP AC 220-230 VDC
LGD-2	GMD-85-110VDC COIL	Coil , 85 AMP AC with 110 VDC contactor
LGD-3	GMD-22-110VDC COIL	Contactor , 3 Pole 110 VDC Coil 7.5 Hp 22 AMP
LGD-3A		Contactor , 3 Pole 48 VDC Coil 22 AMP
LGD-4	GMD-22/R-48VDC	Contactor , 3 Pole Rev., 22 AMP, 48 VDC



Starter Sets

S.E.E.S. #	Description
LGS-1-1	Size 1++, 208 V 34 AMP
LGS-2-1	Size 1++, 120 V 28-40 AMP
LGS-3-1	Size 1++, 240 V 28-40 AMP
S.E.E.S. #	Description
LGS-4-1	Size 2, 120 V 34-50 AMP
LGS-5-1	Size 2, 208 V 34-50 AMP
LGS-6-1	Size 2, 240 V 34-50 AMP

Starter Sets

S.E.E.S. # Description

LGS-7-1	Size 2+, 120V 54-75 AMP
LGS-8-1	Size 2+, 208V 54-75 AMP
LGS-9-1	Size 2+, 240V 54-75 AMP
LGS-10-1	Size 2+, 480V 54-75 AMP



LGS-7-1



LGS-9-1

S.E.E.S. # Description

LGS-11-1	Size 3, 120V, 63-85 AMP
LGS-12-1	Size 3, 208V, 63-85 AMP
LGS-13-1	Size 3, 240V, 63-85 AMP
LGS-14-1	Size 3, 480V, 63-85 AMP



LGS-11-1



LGS-14-1

S.E.E.S. # Description

LGS-15-1	Size 3+, 120 VAC, 100 AMP
LGS-15A-1	Size 3+, 240 VAC, 100 AMP

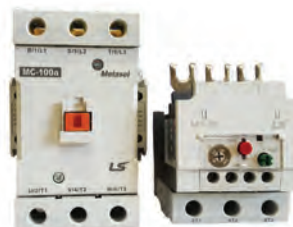

LGS-15-1



LGS-16-1

S.E.E.S. # Description

LGS-17-1	Size 3++, 120 VAC, 125 AMP
LGS-17A-1	Size 3++ 240 VAC, 125 AMP



LGS-16A-1



LGS-17-1

S.E.E.S.# Description

LGS-18-1	Size 4, 120 VAC Coil, 180 AMP
LGS-18A-1	Size 4, 240 VAC Coil, 180 AMP
LGS-19-1	Size 4+, 120 VAC Coil, 120 AMP
LGS-19A-1	Size 4+, 240 VAC Coil, 220 AMP
LGS-20-1	Size 5, 120 VAC Coil, 300 AMP
LGS-20A-1	Size 5, 240 VAC Coil, 300 AMP

Low cost, quality alternative for starter replacement!



Reversing Starter Sets

S.E.E.S. # Description

LGRS-10	Size 0 24 VAC Coil, 16-22 AMP
LGRS-1	Size 1+ 240 VAC, 28-40 AMP
LGRS-2	Size 2 120 VAC, 34-50 AMP
LGRS-3	Size 2 240 VAC, 34-50 AMP
LGRS-4	Size 2+ 120 VAC, 54-75 AMP
LGRS-5	Size 2+ 240 VAC, 54-75 AMP
LGRS-6	Size 3 240 VAC, 63-85 AMP
LGRS-7	Size 3 120 VAC, 63-85 AMP
LGRS-8	Size 3+ 100-240 VAC, 100 AMP
LGRS-9	Size 3++ 110-240V Coil, 85-125A
LGRS-9A	Size 3++ 85-125 AMP, 110 VAC Coil
LGRS-9B	Size 3++ 85-125 AMP, 220 VAC Coil
LGRS-11A	Size 4 120 VAC, 150 AMP
LGRS-11B	Size 4 240 VAC, 150 AMP



LGRS-1



LGRS-3A



LGRS-4



LGRS-7



LGRS-8A



LGRS-11A

S.E.E.S. # Description

LGRS-1B	Mounting Plate for Reversing Starter for LGRS-1 thru LGRS-8
LGRS-1C	Mounting Plate for Reversing Starter for LGRS-9 & 11



Contactors and Thermal Overload Relays



LGAX-3

LGAX-5

LGAX-7



LGAX-8

LGAX-9

LGAX-10



LGAX-11
(FRONT/SIDE VIEW)



LG-10



LG-C16



LG-C17



LG-C15

Auxiliary Contact Blocks

S.E.E.S. #	Description
LGAX-1	Auxiliary Contact Block, 1 pole, 1 N.O. / 1 N.C.
LGAX-2	Auxiliary Contact Block, 4 pole, 4 N.O.
LGAX-3	Auxiliary Contact Block, 4 pole, 2 N.O. / 2 N.C.
LGAX-4	Auxiliary Contact Block, 2 pole, 2 N.C.
LGAX-5	Auxiliary Contact Block, 2 pole, 2 N.O.
LGAX-6	Auxiliary Contact Block, 2 pole, 1 N.O. / 1 N.C.

S.E.E.S. #	O.E.M.#	Description
LGAX-7	AU-100 AUX CONTACT	Auxiliary Contact Block, 1 N.C. & 1 N.O., for GMC-100
LGAX-8	AU-4 3 N.O. 1 N.C.	Auxiliary Contact Block, 3 N.C. & 1 N.O.
LGAX-9	AU-4 4N.C.	Auxiliary Contact Block, 3 N.C. & 1 N.O.
LGAX-10	AU-4 3 N.C. 1 N.O	Auxiliary Contact Block, 3 N.C. & 1 N.O.
LGAX-11	AU-4 2 N.O 2 N.C.	Auxiliary Contact Block, 2 N.C. & 2 N.O.

Coils

S.E.E.S. #	Description
LGC-C1	Coil, 120 VAC for LGS-1, 2, 3
LGC-C2	Coil, 208 VAC for LGS-1, 2, 3
LGC-C3	Coil, 220 VAC for LGS-1, 2, 3
LGC-C5	Coil, 440 VAC for LGS-1, 2, 3
LGC-C6	Coil, 120 VAC for LGS-4 thru LGS-14
LGC-C7	Coil, 208 VAC for LGS-4 thru LGS-14
LGC-C10	Coil, 440 VAC for LGS-4 thru LGS-14
LGC-C12	Coil, 110 VDC for ARP-62
LGC-C13	Coil, 110 VDC for ARP-63
LGC-C14	Coil, 24 VAC for LGRS-10
LGC-C16	Coil, 125 VDC for GMD 9-40 Contactors
LGC-C17	Coil, 125 VDC for GMD 50-85 Contactors

S.E.E.S. #	O.E.M. #	Description
LGC-10	GMC-9-40 24 VAC COIL	Coil, GMC-9-40 24 VAC
LGC-C15	GMCO100/150-100-240 VAC	DC Contactor, 100-240 VAC, for GMC-100 >150

Mechanical Interlocks

S.E.E.S. #	Description
LGIL-1	Mechanical Interlock for LGRS-1 thru LGRS-8
LGIL-2	Mechanical Interlock for LGRS-9 & LGRS-11

Contactors and Thermal Overload Relays



Overload Adaptors

S.E.E.S. #	Description
LG0A-1	Din Rail Overload Adaptor for LGOL-1
LG0A-2	Din Rail Overload Adaptor for LGOL-3, 4

S.E.E.S. #	O.E.M. #	Description
LGOL-1	GTK-40/28-40A	Overload Relay, 40, 28-40 AMP ADJ
LGOL-4	GTK-85/63-85A	Overload Relay, 85, 63-85 AMP ADJ
LGOL-5	GTK-100/65-100A	Overload Relay, 100, 65-100 AMP ADJ
LGOL-6	GTK-150/100-150A	Overload Relay, 150, 100-150 AMP



LG0A-2

Starters with Mounting Kit

S.E.E.S. #	Description
LGS-9D	LGS-9 with Din Rail Kit, Size 2+

Digital Motor Protection Relay

S.E.E.S. #	Description
LGM-1	Digital Motor Protection Relay, 5-60amp
PR-131	Overload Relay, 3P 10.5 - 15 A, Class 10
PR-131A	Relay, Socket



LGOL-6

Motor Couplings

S.E.E.S. #	Description
LGMC-001A	LG Motor Coupling Shaft Assy w/ Bushing
LGMC-001	Motor Coupling only, 69mm OD x 30mm ID x 22mm Tk 80 Duro Urethane



PR-131

IGBT Blocks

S.E.E.S. #	Description
L-IGBT-2	IGBT Block # CM200-DY24A
L-IGBT-3	IGBT Block # CM100E3Y-24NF
L-CS-1	Hall, Current Sensor, HC-WT100V4B15
L-CS-1-CABLE	Cable for L-CS-1

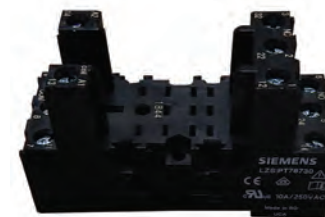

PR-131A

SPRECHER + SCHUH

Coils

S.E.E.S. #	Description
TA296	Coil, 208-240 VAC, 60Hz, fits CA7-9
TA475	Coil, 440 VAC, 50Hz, 480 VAC, 60Hz
TA733	Coil, 110 VDC, fits CA7-9
TA851	Coil, 230V
TA855	Coil, 24 VAC, 50/60Hz, fits CA 7-9
TA860	Coil, 48 VAC, 50/60Hz, fits CA7-9



TA296

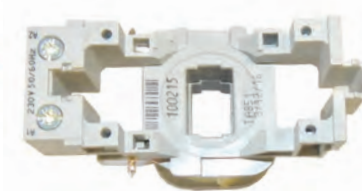

TA851

SPRECHER + SCHUH

Catalog Number Coding

Sprecher+Schuh employs a catalog number coding system for contactors (and many other devices) that follows a logical pattern, where every digit signifies a specific device attribute. Where indicated, the use of dashes (-) serves to separate device characteristics and should always be used when ordering.

The following example illustrates some of the possible combinations when specifying contactors and reversing contactors.

XX	XXX	-	XX	-	XXX																																																								
Configuration	Contactor Series Currents		Auxiliary Contacts		Coil Code																																																								
CA Contactor CAU Reversing Contactors CAT Motor Starter CAUT Reversing Motor Starter	<table border="1"> <thead> <tr> <th>Series CA7</th> <th>Series CA6</th> </tr> </thead> <tbody> <tr><td>9</td><td>115</td></tr> <tr><td>12</td><td>140</td></tr> <tr><td>16</td><td>180</td></tr> <tr><td>23</td><td>210</td></tr> <tr><td>30</td><td>250</td></tr> <tr><td>37</td><td>300</td></tr> <tr><td>55</td><td>420</td></tr> <tr><td>43</td><td>630</td></tr> <tr><td>60</td><td>860</td></tr> <tr><td>72</td><td></td></tr> <tr><td>85</td><td></td></tr> <tr><td>97</td><td></td></tr> </tbody> </table>	Series CA7	Series CA6	9	115	12	140	16	180	23	210	30	250	37	300	55	420	43	630	60	860	72		85		97			-10 N.O. Auxiliary -01 N.C. Auxiliary -11 N.O. & N.C. Auxiliary -00 No Auxiliaries 4-pole CA7 -M40 4 N.O. Power Poles -M31 3 N.O. Power Poles/ 1 N.C. Power Pole -M22 2 N.O. Power Poles/ 2 N.C. Power Pole		<table border="1"> <thead> <tr> <th>AC</th> <th>DC</th> </tr> </thead> <tbody> <tr><td>24Z</td><td>12E, 12DD</td></tr> <tr><td>120</td><td>24E, 24DD</td></tr> <tr><td>208</td><td>24W</td></tr> <tr><td>220W</td><td>36E</td></tr> <tr><td>240</td><td>48E, 48DD</td></tr> <tr><td>277</td><td>110E, 110DD</td></tr> <tr><td>380</td><td>220E, 220DD</td></tr> <tr><td>480</td><td></td></tr> <tr><td>600</td><td></td></tr> <tr> <th>DC</th> <td></td> </tr> <tr><td>24W</td><td></td></tr> <tr><td>48W</td><td></td></tr> <tr><td>120W</td><td></td></tr> <tr><td>480W</td><td></td></tr> </tbody> </table>	AC	DC	24Z	12E, 12DD	120	24E, 24DD	208	24W	220W	36E	240	48E, 48DD	277	110E, 110DD	380	220E, 220DD	480		600		DC		24W		48W		120W		480W	
Series CA7	Series CA6																																																												
9	115																																																												
12	140																																																												
16	180																																																												
23	210																																																												
30	250																																																												
37	300																																																												
55	420																																																												
43	630																																																												
60	860																																																												
72																																																													
85																																																													
97																																																													
AC	DC																																																												
24Z	12E, 12DD																																																												
120	24E, 24DD																																																												
208	24W																																																												
220W	36E																																																												
240	48E, 48DD																																																												
277	110E, 110DD																																																												
380	220E, 220DD																																																												
480																																																													
600																																																													
DC																																																													
24W																																																													
48W																																																													
120W																																																													
480W																																																													

9AMP Contactors

S.E.E.S. #	Description
CA7-9-10-120	9 AMP 120 VAC 1 N.O.
CA7-9-01-120	9 AMP 120 VAC 1 N.C.
CA7-9-10-220W	9 AMP 220 VAC 1 N.O.
CA7-9-01-220W	9 AMP 220 VAC 1 N.C.
CA7-9-10-480	9 AMP 480 VAC 1 N.O.
CA7-9-01-480	9 AMP 480 VAC 1 N.C.
CA7-9-M31-208	9 AMP 208V Coil 3 N.O. & 1 N.C.
CA7-9E-10-24E	9 AMP 24 VDC 1 N.O.
CA7-9E-01-24E	9 AMP 24 VDC 1 N.C.
CA7-9E-10-110E	9 AMP 110 VDC 1 N.O.
CA7-9E-01-110E	9 AMP 110 VDC 1 N.C.

9AMP Reversing Contactors

S.E.E.S. #	Description
CAU7-9-22-120	Reversing Contactor, 9A, 2 N.O. 2 N.C., 120V
CAU7-9-22-220W	Reversing Contactor, 9A, 2 N.O. 2 N.C., 220W

12AMP Contactors

S.E.E.S. #	Description
CA7-12-10-24Z	12 AMP 24 VAC 1 N.O.
CA7-12-10-120	12 AMP 120 VAC 1 N.O.
CA7-12-01-120	12 AMP 120 VAC 1 N.C.
CA7-12-10-220W	12 AMP 220 VAC 1 N.O.
CA7-12-01-220W	12 AMP 220 VAC 1 N.C.
CA7-12-10-480	12 AMP 480 VAC 1 N.O.
CA7-12-01-480	12 AMP 480 VAC 1 N.C.
CA7-12E-10-24E	12 AMP 24 VDC 1 N.O.
CA7-12E-01-24E	12 AMP 24 VDC 1 N.C.
CA7-12E-10-110E	12 AMP 110 VDC 1 N.O.
CA7-12E-01-110E	12 AMP 110 VDC 1 N.C.

12AMP Reversing Contactors

S.E.E.S. #	Description
CAU7-12E-22-110E	12 AMP 110 VDC 2 N.O. & 2 N.C.
CAU7-12E-22-24E	12 AMP 24 VDC 2 N.O. & 2 N.C.
CAU7-12E-22-36E	12 AMP 36 VDC 2 N.O. & 2 N.C.



Small Block Reverser



CA7-12-01-120

16AMP Contactors

S.E.E.S. #	Description
CA7-16-10-120	16 AMP 120 VAC 1 N.O.
CA7-16-01-120	16 AMP 120 VAC 1 N.C.
CA7-16-10-220W	16 AMP 220 VAC 1 N.O.
CA7-16-01-220W	16 AMP 220 VAC 1 N.C.
CA7-16-10-480	16 AMP 480 VAC 1 N.O.
CA7-16-01-480	16 AMP 480 VAC 1 N.C.
CA7-16E-10-24E	16 AMP 24 VDC 1 N.O.
CA7-16E-01-24E	16 AMP 24 VDC 1 N.C.
CA7-16E-10-48E	16 AMP 48 VDC 1 N.O.
CA7-16E-10-110E	16 AMP 110 VDC 1 N.O.
CA7-16E-01-110E	16 AMP 110 VDC 1 N.C.
CA7-16E-01-110E	16 AMP 110 VDC 3 N.O. & 1 N.C.



CA7-16-01-220W

30AMP Reversing Starters

S.E.E.S. #	Description
CAUT7-30-120-EFD	30 AMP 120 VAC, no aux contacts
CAUT7-30-220W-EFD	30 AMP 220 VAC, no aux contacts
CAUT7-30-480-EFD	30 AMP 480 VAC, no aux contacts
CAUT7-30E-24E-EFD	30 AMP 24 VDC, no aux contacts
CAUT7-30E-110E-EFD	30 AMP 110 VDC, no aux contacts



CAUT7-30-480-EFD

23AMP Contactors

S.E.E.S. #	Description
CA7-23-10-24	23 AMP 24 VAC 1 N.O.
CA7-23-10-120	23 AMP 120 VAC 1 N.O.
CA7-23-01-120	23 AMP 120 VDC 1 N.C.
CA7-23-10-220W	23 AMP 220 VAC 1 N.O.
CA7-23-01-220W	23 AMP 220 VAC 1 N.C.
CA7-23-10-480	23 AMP 480 VAC 1 N.O.
CA7-23-01-480	23 AMP 480 VAC 1 N.C.
CA7-23E-10-24E	23 AMP 24 VDC 1 N.O.
CA7-23E-01-24E	23 AMP 24 VDC 1 N.C.
CA7-23E-10-110E	23 AMP 110 VDC 1 N.O.
CA7-23E-01-110E	23 AMP 110 VDC 1 N.C.

23AMP Reversing Contactor

S.E.E.S. #	Description
CAU7-23E-22-110E	23 AMP 110 VDC 2 N.O. & 2 N.C.

30AMP Contactors

S.E.E.S. #	Description
CA7-30-00-120	30 AMP 120 VAC no aux contacts
CA7-30-00-220W	30 AMP 220 VAC no aux contacts
CA7-30-00-480	30 AMP 480 VAC no aux contacts
CA7-30E-00-24E	30 AMP 24 VDC no aux contacts
CA7-30E-00-110E	30 AMP 110 VDC no aux contacts
CA7-30E-00-220E	30 AMP 220 VDC no aux contacts
CA7-30-00-120-L22	30 AMP 120 VAC Plus Aux, 2 N.O. & 2 N.C.

30AMP Starters

S.E.E.S. #	Description
CAT7-30-120-EFD	30 AMP 120 VAC, no aux contacts
CAT7-30-220W-EFD	30 AMP 220 VAC, no aux contacts
CAT7-30-480-EFD	30 AMP 480 VAC, no aux contacts
CAT7-30E-24E-EFD	30 AMP 24 VDC, no aux contacts
CAT7-30E-110E-EFD	30 AMP 110 VDC, no aux contacts



CAT7-30-00-110E



Block Contactor



Block Reverser



SPRECHER + SCHUH

43AMP Contactors

S.E.E.S. #	Description
CA7-43-00-120	43 AMP 120 VAC no aux contacts
CA7-43-00-220W	43 AMP 220 VAC no aux contacts
CA7-43-00-480	43 AMP 480 VAC no aux contacts
CA7-43E-00-24E	43 AMP 24 VDC no aux contacts
CA7-43E-00-110E	43 AMP 110 VDC no aux contacts

43AMP Starters

S.E.E.S. #	Description
CAT7-43-120-EFD	43 AMP 120 VAC 9-45A, no aux contacts
CAT7-43-220W-EFD	43 AMP 220 VAC 9-45A, no aux contacts
CAT7-43-480-EFD	43 AMP 480 VAC 9-45A, no aux contacts
CAT7-43E-24E-EFD	43 AMP 24 VDC 9-45A, no aux contacts
CAT7-43E-110E-EFD	43AMP 110 VDC 9-45A, no aux contacts

43AMP Reversing Starters

S.E.E.S. #	Description
CAUT7-43-120-EFD	43 AMP 120 VAC 9-45A, no aux contacts
CAUT7-43-220W-EFD	43 AMP 220 VAC 9-45A, no aux contacts
CAUT7-43-220W-MH	43 AMP 220 VAC Coil
CAUT7-43-480-EFD	43 AMP 480 VAC 9-45A, no aux contacts
CAUT7-43E-24E-EFD	43 AMP 24 VDC 9-45A, no aux contacts
CAUT7-43E-110E-EFD	43 AMP 110 VDC 9-45A, no aux contacts

55AMP Reversing Contactor

S.E.E.S. #	Description
CAU7-55-22-120	55 AMP 110 VDC 2 N.O. 2 N.C.

60AMP Contactors

S.E.E.S. #	Description
CA7-60-00-110D	60 AMP 110 VDC coil, 3 pole
CA7-60-00-120	60 AMP 120 VAC no aux contacts
CA7-60-00-220W	60 AMP 220 VAC no aux contacts
CA7-60-00-480	60AMP 480 VAC no aux contacts
CA7-60D-00-24DD	60 AMP 24 VDC no aux contacts
CA7-60D-00-110DD	60 AMP 110 VDC no aux contacts

60AMP Starters

S.E.E.S. #	Description
CAT7-60-120-EGE	60 AMP 120 VAC 18-90A, no aux contacts
CAT7-60-220W-EGE	60AMP 220 VAC 18-90A, no aux contacts
CAT7-60-220W-EGE-L22	60A MAG MOTOR STARTER with 120V-C
CAT7-60-480-EGE	60AMP 480 VAC 18-90A, no aux contacts
CAT7-60D-24DD-EGE	60AMP 24 VDC 18-90A, no aux contacts
CAT7-60D-110DD-EGE	60AMP 110 VDC 18-90A, no aux contact

60AMP Reversing Starters

S.E.E.S. #	Description
CAUT7-60-120-EGE	60 AMP 120 VAC, no aux contacts
CAUT7-60-220W-EGE	60 AMP 220 VAC, no aux contacts
CAUT7-60-480-EGE	60 AMP 480 VAC, no aux contacts
CAUT7-60D-24DD-EGE	60 AMP 24 VDC, no aux contacts
CAUT7-60D-110DD-EGE	60 AMP 110 VDC, no aux contacts

72AMP Contactors

S.E.E.S. #	Description
CA7-72-00-120	72 AMP 120 VAC no aux contacts
CA7-72-00-220W	72 AMP 220 VAC no aux contacts
CA7-72-00-480	72 AMP 480 VAC no aux contacts
CA7-72D-00-24DD	72 AMP 24 VDC no aux contacts
CA7-72D-00-110DD	72 AMP 110 VDC no aux contacts

72AMP Starters

S.E.E.S. #	Description
CA7-72-120-EGE	72 AMP 120 VAC 18-90A, no aux contacts
CA7-72-220W-EGE	72 AMP 220 VAC 18-90A, no aux contacts
CA7-72-480-EGE	72 AMP 480 VAC 18-90A, no aux contacts
CA7-72D-24DD-EGE	72 AMP 24 VDC 18-90A, no aux contacts
CA7-72D-110DD-EGE	72 AMP 110 VDC 18-90A, no aux contacts

72AMP Reversing Starters

S.E.E.S. #	Description
CAUT7-72-120-EGE	72 AMP 120 VAC 18-90A, no aux contacts
CAUT7-72-220W-EGE	72 AMP 220 VAC 18-90A, no aux contacts
CAUT7-72-480-EGE	72 AMP 480 VAC 18-90A, no aux contacts
CAUT7-72D-24DD-EGE	72 AMP 24 VDC 18-90A, no aux contacts
CAUT7-72D-110DD-EGE	72 AMP 110 VDC 9-45A, no aux contacts

85AMP Contactors

S.E.E.S. #	Description
CA7-85-00-120	85 AMP 120 VAC no aux contacts
CA7-85-00-220W	85 AMP 220 VAC no aux contacts
CA7-85-00-480	85 AMP 480 VAC no aux contacts
CA7-85D-00-24DD	85 AMP 24 VDC no aux contacts
CA7-85D-00-110DD	85 AMP 110 VDC no aux contacts
CA7-85D-00-110DD-L22	85 A 3 POLE 120 DC 2 N.O., 2 N.C.



CAT7-72-220W



CA7-43-00-220W



CA7-60-00-120

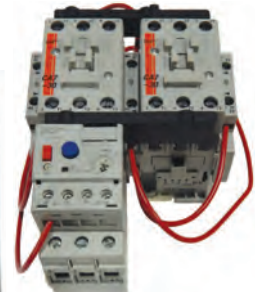

CA7-85-00-220W

85AMP Starters

S.E.E.S. #	Description
CA7-85-120-EGE	85 AMP 120 VAC, no aux contacts
CA7-85-220W-EGE	85 AMP 220 VAC, no aux contacts
CA7-85-480-EGE	85 AMP 480 VAC, no aux contacts
CA7-85D-24DD-EGE	85 AMP 24 VDC, no aux contacts
CA7-85D-110DD-EGE	85 AMP 110 VDC, no aux contacts

85AMP Reversing Starters

S.E.E.S. #	Description
CAUT7-85-120-EGE	85 AMP 120 VAC, no aux contacts
CAUT7-85-220W-EGE	85 AMP 220 VAC, no aux contacts
CAUT7-85-480-EGE	85 AMP 480 VAC, no aux contacts
CAUT7-85D-24DD-EGE	85 AMP 24 VDC, no aux contacts
CAUT7-85D-110DD-EGE	85 AMP 110 VDC, no aux contacts

Auxiliary Contacts & Accessories

S.E.E.S. #	Description
CA7-PA-10	N.O. side mount auxiliary (13-14 / 43-44)
CA7-PA-01	N.C. side mount auxiliary (21-22 / 31-32)
CA7-PA-11	Auxiliary contact , side mount 1 N.O. 1 N.C.
CA7-PV-L11	Top mount auxiliary (13-14 21-22), 1EM / 1LB
CA7-PV-22	2 N.O. / 2 N.C. Top mount auxiliary
CA7-PV-02	2 N.C. Top mount auxiliary (11-12 21-22)
CA8-PO4	Auxiliary contact
CS7-PV-11	Control Relay , 2 POLE 1 N.O. 1 N.C.
CS7-PV-13	Control Relay , 4 POLE 1 N.O. 3 N.C.
CS7-PV-20	2 N.O. Top mount auxiliary (53-54/63-64)
CS7-PV-22	Control Relay , 4 POLE 2 N.O. 2 N.C.
CS7-PV-40	4 N.O. Top mount auxiliary
CS7-PV-04	4 N.C. Top mount auxiliary
CS7-40E-120	Control Relay , 4 POLE 4 N.O. 120 VAC
CM7-02	Mechanical interlink with 2NC auxiliary contacts
CM8	Interlock
CRD8-250	Surge Suppressor
CA8-09C-01-24D	Relay , 9A - 24 VDC - 1NC - DIN Rail

Overload Relays

S.E.E.S. #	Description
CEP7-EPE	Overload Relay , Adaptor Din Rail
CEP7-EEFD	Overload Relay
CEP7-EEGE	Overload Relay , Adj 18-90A For CA7-60 thru -85 contactors
CEP7-EEHF	Overload Relay , Solid State, Adj 30-150 AMPS, for CA6-115 thru -140
CEP7A32-5-20	Overload Relay , 1.6-5A, 3PH, (CA4 and CA7-9-23)
CEP7-M32-2.9-10	Overload Relay , 1.0-2.9A, 3PH, (CA4 and CA7-9-23)
CEP7-M32-32-10	Overload Relay , 12.32A, 3PH, (CA4 and CA7-9-23)
CEP7-M32-5-10	Overload Relay , 1.6-5.0A, 3PH, (CA4 and CA7-9-23)
CEP7-M37-37-10	Overload Relay , 12-37A, 3PH, (CA4 and CA7-30-37)
CEP7-M45-45-10	Overload Relay , 14-45A, 3PH, (CA4 and CA7-43)
CEP7-M85-85-10	Overload Relay , 26-85A, 3PH, (CA4 and CA7-60-85)
CEP7S-EEUE	Overload Relay , 1PH AUTO/MAN 18-90A

97AMP Contactors

S.E.E.S. #	Description
CA7-97-00-120	97 AMP 120 VAC no aux contacts
CA7-97-00-220W	97 AMP 220 VAC no aux contacts
CA7-97-00-480	97 AMP 480 VAC no aux contacts
CA7-97D-00-24DD	97 AMP 24 VDC no aux contacts
CA7-97D-00-110DD	97 AMP 110 VDC no aux contacts
CA7-97-10-220W	97 AMP 220 Coil, 1 N.O.

97AMP Starters

S.E.E.S. #	Description
CA7-97-120-EVE	97 AMP 120 VAC 60-120A, no aux contacts
CA7-97-220W-EVE	97 AMP 220 VAC 60-120A, no aux contacts
CA7-97-480-EVE	97 AMP 480 VAC 60-120A, no aux contacts
CA7-97D-24DD-EVE	97 AMP 24 VDC 60-120A, no aux contacts
CA7-97D-110DD-EVE	97 AMP 110 VDC 60-120A, no aux contacts

97AMP Reversing Starters

S.E.E.S. #	Description
CAUT7-97-120-EVE	97 AMP 120 VAC, no aux contacts
CAUT7-97-220W-EVE	97 AMP 220 VAC, no aux contacts
CAUT7-97-480-EVE	97 AMP 480 VAC, no aux contacts
CAUT7-97D-24DD-EVE	97 AMP 24 VDC, no aux contacts
CAUT7-97D-110DD-EVE	97 AMP 110 VDC, no aux contacts

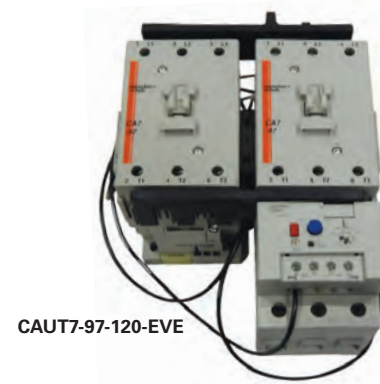
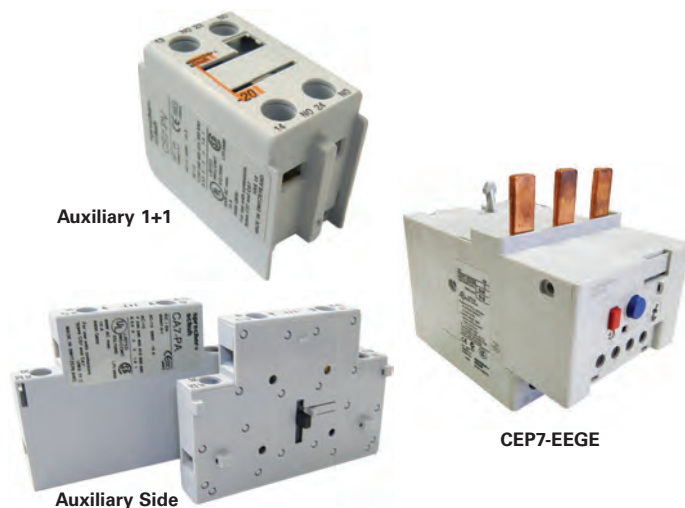



SPRECHER + SCHUH

115AMP Contactors

S.E.E.S. #	Description
CA6-115-11-120B	115 AMP 120 VAC 1 N.O., 1 N.C.
CA6-115-11-220W	115 AMP 220 VAC 1 N.O., 1 N.C.
CA6-115-11-480	115 AMP 480 VAC 1 N.O., 1 N.C.
CA6-115-L22-24D	115 AMP 24 VDC 2 N.O., 1 N.C., 1late breakNC
CA6-115-L22-110D	115 AMP 110 VDC 2 N.O., 1 N.C., 1late breakNC
CA9-116-11-120W	116 AMP 120 VAC Coil, 1 N.O., 1 N.C.

115AMP Starters

S.E.E.S. #	Description
CAT6-115-120B-EHF	115 AMP 120 VAC 30-150A
CAT6-115-220W-EHF	115 AMP 220 VAC 30-150A
CAT6-115-480-EHF	115 AMP 480 VAC 30-150A
CAT6-115-24D-EHF	115 AMP 24 VDC 30-150A
CAT6-115-110D-EHF	115 AMP 110 VDC 30-150A

115AMP Reversing Starters

S.E.E.S. #	Description
CAUT6-115-120B-EHF	115 AMP 120 VAC 30-150A
CAUT6-115-220W-EHF	115 AMP 220 VAC 30-150A
CAUT6-115-480-EHF	115 AMP 480 VAC 30-150A
CAUT6-115-24D-EHF	115 AMP 24 VDC 30-150A
CAUT6-115-110D-EHF	115 AMP 110 VDC 30-150A

140AMP Contactors

S.E.E.S. #	Description
CA6-140-11-120B	140 AMP 120 VAC 1 N.O., 1 N.C.
CA6-140-11-220W	140 AMP 220 VAC 1 N.O., 1 N.C.
CA6-140-11-480	140 AMP 480 VAC 1 N.O., 1 N.C.
CA6-140-L22-24D	140 AMP 24 VDC 2 N.O., 1 N.C., 1late breakNC
CA6-140-L22-110D	140 AMP 110 VDC 2 N.O., 1 N.C., 1late breakNC
CA6-140-11-220W	140 AMP 220 VAC, 1 N.O., 1 N.C. Aux.

140AMP Starters

S.E.E.S. #	Description
CAT6-140-120B-EHF	140 AMP 120 VAC 30-150A
CAT6-140-220W-EHF	140 AMP 220 VAC 30-150A
CAT6-140-480-EHF	140 AMP 480 VAC 30-150A
CAT6-140-24D-EHF	140 AMP 24 VDC 30-150A
CAT6-140-110D-EHF	140 AMP 110 VDC 30-150A

140AMP Reversing Starters

S.E.E.S. #	Description
CAUT6-140-120B-EHF	140 AMP 120 VAC 30-150A
CAUT6-140-220W-EHF	140 AMP 220 VAC 30-150A
CAUT6-140-480-EHF	140 AMP 480 VAC 30-150A
CAUT6-140-24D-EHF	140 AMP 24 VDC 30-150A
CAUT6-140-110D-EHF	140 AMP 110 VDC 30-150A
CAUT9-146-120W-EHJ	146 AMP 120 VAC

Power Wire Kits

S.E.E.S. #	Description
CAUT7-PW23	Reversing Wiring Kit, 9-23A
CAUT7-PW37	Reversing Wiring Kit, 30-37A
CAUT7-PW43	Reversing Wiring Kit, 43A
CAUT7-PW85	Reversing Wiring Kit, 60-85A

180AMP Contactors

S.E.E.S. #	Description
CA6-180-11-120B	180 AMP 120 VAC 1 N.O., 1 N.C.
CA6-180-11-220W	180 AMP 220 VAC 1 N.O., 1 N.C.
CA6-180-EI-11-220W	180 AMP 220V ELEC Coil, 1 N.O., 1 N.C.
CA6-180-11-240	180 AMP 220 VAC 2 N.O., 2 N.C.
CA6-180-11-480	180 AMP 480 VAC 1 N.O., 1 N.C.
CA6-180-L22-110D	180 AMP 110 VDC 2 NO, 2 NC, 1late breakNC

180AMP Starters

S.E.E.S. #	Description
CAT6-180-120B-EJF	180 AMP 120 VAC 40-200A
CAT6-180-220W-EJF	180 AMP 220 VAC 40-200A
CAT6-180-480-EJF	180 AMP 480 VAC 40-200A
CAT6-180-24D-EJF	180 AMP 24 VDC 40-200A
CAT6-180-110D-EJF	180 AMP 110 VDC 40-200A

180AMP Reversing Starters

S.E.E.S. #	Description
CAUT6-180-120B-EJF	180 AMP 120 VAC 40-200A
CAUT6-180-220W-EJF	180 AMP 220 VAC 40-200A
CAUT6-180-480-EJF	180 AMP 480 VAC 40-200A
CAUT6-180-24D-EJF	180 AMP 24 VDC 40-200A
CAUT6-180-110D-EJF	180 AMP 110 VDC 40-200A

Auxiliary Contacts

S.E.E.S. #	Description
CA9-S1-11	Auxiliary Contact
CA9-S2-11	Auxiliary Contact, 1 N.O. / 1 N.C.

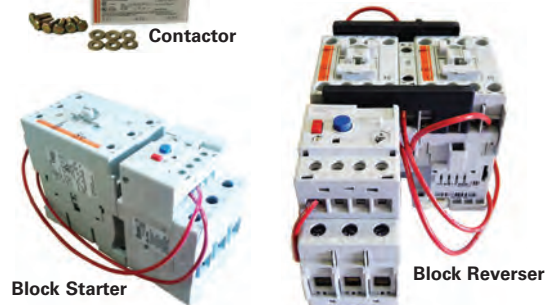

SPRECHER + SCHUH

Solid State

S.E.E.S. #	Description
PCEC-032-600V-120V	S&S Soft Starter 32A 600V 120 VAC Y/D
PCEC-032-600V-230V	S&S Soft Starter 32A 600V 230 VAC Y/D
PCEC-051-600V-120V	S&S Soft Starter 51A 600V 120 VAC Y/D
PCEC-051-600V-230V	S&S Soft Starter 51A 600V 230 VAC Y/D
PCEC-064-600V-120V	S&S Soft Starter 64A 600V 120 VAC Y/D
PCEC-064-600V-230V	S&S Soft Starter 64A 600V 230 VAC Y/D
PCEC-074-600V-120V	S&S Soft Starter 74A 600V 120 VAC Y/D
PCEC-074-600V-230V	S&S Soft Starter 74A 600V 230 VAC Y/D
PCEC-104-600V-120V	S&S Soft Starter 104A 600V 120 VAC Y/D
PCEC-104-600V-230V	S&S Soft Starter 104A 600V 230 VAC Y/D
PCEC-147-600V-120V	S&S Soft Starter 147A 600V 120 VAC Y/D
PCEC-147-600V-230V	S&S Soft Starter 147A 600V 230 VAC Y/D
PCEC-234-600V-120V	S&S Soft Starter 234A 600V 120 VAC Y/D
PCEC-234-600V-230V	S&S Soft Starter 234A 600V 230 VAC Y/D

■ QUIET OPERATION for applications that require NO NOISE. The solution for those problem jobs where starter noise is objectionable.

In Line

S.E.E.S. #	Description
PCS-003-600V	Soft Starter, 3 Wire 3 AMP 600V
PCS-009-600V	Soft Starter, 3 Wire 9A 600V
PCS-016-600V	Soft Starter, 3 Wire 16A 600V
PCS-019-600V	Soft Starter, 3 Wire 20A 600V
PCS-025-600V	Soft Starter, 3 Wire 25A 600V
PCS-037-600V	Soft Starter, 3 wire 37 AMP
PCS-085-600V	Starter, Solid State, 85 AMP
PCS-PA-01	Auxiliary Contact Block, 1-N.C.
PCS-PA-10	Auxiliary Contact Block, 1-N.O.
PCS-PA-11	Auxiliary Contact Block, 1-N.O. 1-N.C.
PCS-PA-20	Auxiliary Contact Block, 2-N.O.
PCS-23-CI23	Connecting Module for CA7-9-23
PCS-25S-CC25	Connecting Module for KT7-25S
PCS-37-CI37	Connecting Module for CA7-9-37
PCS-37-CI37	Connecting Module for CA7-9-37
PCS-45H-CF45	Connecting Module for KT7-45H

Solid State Starters

Furnace, Nordic Type Solid State Hydro Motor Starters

S.E.E.S. #	Description
MIS-NOR-001	Soft Start Starter 5-15 HP 22 AMP Y/D
MIS-NOR-002	Soft Start Starter 7.5-25 HP 35 AMP Y/D
MIS-NOR-003	Soft Start Starter 10-30 HP 42 AMP Y/D
MIS-NOR-004	Soft Start Starter 15-40 HP 55 AMP Y/D
MIS-NOR-005	Soft Start Starter 25-50 HP 68 AMP Y/D
MIS-NOR-006	Soft Start Starter 25-60 HP 80 AMP Y/D
MIS-NOR-007	Soft Start Starter 30-75 HP 105 AMP Y/D
MIS-NOR-008	Soft Start Starter 10-100 HP 130 AMP Y/D
MIS-NOR-009	Soft Start Starter 50-125 HP 157 AMP Y/D
MIS-NOR-010	Soft Start Starter 75-100 HP 252 AMP Y/D
MIS-NOR-TR-01	Transformer, Multi-Volt step-down 208-230-460V to 120V
MIS-NOR-TR-02	Transformer, Multi-Volt step-down 208-230-460V to 24V
MIS-NOR-PCB-001	PCB, Siemens class 72G starter replacement logic board

■ QUIET OPERATION for applications that require NO NOISE. The solution for those problem jobs where starter noise is objectionable.



PCEC-051-600V-120V



PCEC-064-600V-120V



PCEC-064-600V-230V



PCEC-074-600V-120V



PCS-025-600V



PCEC-147-600V-120V



PCS-PA-11



PCS-PA-20



MIS-NOR-004



MIS-NOR-007



MIS-NOR-TR-01



MIS-NOR-PCB-001

Additional O.E.M. Contactors & Starters

Allen Bradley

S.E.E.S. #	O.E.M. #	Description	Additional Description
ABC-001	104C16D22	Reversing Contactor , 600V 16A 3 Pole	120 VAC coil
ABC-002	1370-NC56	Contactor , 600V 260A 2 Pole	120 VAC coil
ABC-003	505-AOD	Reversing Starter , 20A 6 Pole 2 N.O.	120 VAC coil, 2 N.O.
ABC-004	505-COH-7-19C	Reversing Starter , 6 Pole 45A	208 VAC coil, size 2 Nema, 1N.O.
ABC-005	509-DOA	Starter , 3 Pole 90A 240 VAC	240 VAC coil, 1 N.O.
ABC-006	EHDB130C-11	Contactor , 600V 130A 3 Pole	120 VAC coil, 2 N.O./2 N.C. Aux
ABC-007	EHN145C-211	Contactor , 600V 145A 3 Pole	240 VAC coil, 2 N.O./2N.C. Aux
ABC-008	EH210C-2	Contactor , 600V 210A 3 Pole	240 VAC coil, 1 N.O./1 N.C. Aux
ABC-009	EHDB220C-1L11	Contactor , 600V 220A 3 Pole	120 VAC coil, 2 N.O./2 N.C. Aux
ABC-010	EHDB280C-1L11	Contactor , 600V 280A 3 Pole	120 VAC coil, 2 N.O./2 N.C. Aux
ABC-011	EHDB280C-20-11	Contactor , 600V 280A 3 Pole	240 VAC coil, 2 N.O./2 N.C. Aux
ABC-012	EHDB360C-1L11	Contactor , 600V 360A 3 Pole	120 VAC coil, 2 N.O./2 N.C. Aux
ABC-013	EG40-1	Reversing Contactor , 600V 45A 3 Pole	120 VAC coil, 2 N.O./2 N.C. Aux
ABC-014	300B230P	Reversing Contactor , 600V 45A 3 Pole	208 VAC coil, 2 N.O./2 N.C. Aux
ABC-015	100-C60D10	Contactor , 60A 3 Pole	120 VAC coil, 1 N.O. Aux
ABC-016	100-SA02	Auxiliary Contact Block , Side Mount, 2 N.C. Contact	
ABC-017	100-SA10	Auxiliary Contact Block , Side Mount, 1 N.O. Contact	
ABC-018	100-SA11	Auxiliary Contact Block , Side Mount, 1 N.O. 1 N.C.	
CKABB-130-2NO		Contact Kit , EHDB130 2 N.O.	
CKABB-130-1NC		Contact Kit , EHDB130 1 N.C.	
CKABB-280-2NO	ABB EHDB280CK-2	Contact Kit , EHD280 2 N.O.	
CKAB-7		Contact Kit for Allen Bradley , 3, 1 Pole	
ABBC-01	A16-30-10-42	Contactor , 30A,	230-240 VAC, 1 N.O. Aux.
ABBC-02	A30-30-120-120ADC	Contactor , 30A, 120 VAC	Coil 1 N.O. Aux.
ABBC-10	KH210DC	Replacement Coil	110 VDC
ABC-019	CA5-22E	Auxiliary Contact Block , CA5 Series, CA5-22E	



ABC-017



CKAB-7



ABBC-10



FNC-001



FNC-001A



FNC-001B

Cutler Hammer

S.E.E.S. #	O.E.M. #	Description	Additional Description
CHC-001	A201K2CB	Contactor , 600V 45A 3 Pole NEMA 2	208 VAC coil, 1N.O./1N.C. Aux
CHC-002	A201K3CW	Contactor , 600V 90A 3 Pole NEMA 3	240 VAC coil, 1N.O./1N.C. Aux
CHC-003	A201K3CB	Contactor , 600V 90A 3 Pole NEMA 3	208 VAC coil, 1N.O./1N.C. Aux
CHC-004	A201K4CB	Contactor , 600V 135A 3 Pole NEMA 4	208 VAC coil, 1N.O./1N.C. Aux
CHC-005	A211K2CB	Reversing Contactor , 600V 45A 6 Pole NEMA 2	208 VAC coil, 2N.O./2N.C. Aux
CHC-006	A211K3CB	Reversing Contactor , 600V 90A 6 Pole NEMA 3	208 VAC coil, 2N.O./2N.C. Aux
CHC-007	A211K3CB	Reversing Contactor , 600V 90A 6 Pole NEMA 3	120 VAC coil, 1N.O./1N.C. Aux
CHC-008	A211K3CW	Reversing Contactor , 600V 90A 6 Pole NEMA 3	240 VAC coil, without auxiliary
CKCH-11		Contact Kit , Cutler Hammer, 3 Pole 6-65-8	

Fujitec

S.E.E.S. #	O.E.M. #	Description	Additional Description
FUC-001	SC-5N	Contactor , 600V 125A 3 Pole	120 VAC coil, 2 N.O. Aux

Furnas

S.E.E.S. #	O.E.M. #	Description	Additional Description
FNC-001	40FP32AF	Contactor , 600V 45A 3 Pole #2	120 VAC coil, 1 N.O. Aux
FNC-001A	9818194	Starter , Size 3, 90A, 120AC Coil	
FNC-001B	9788750	Relay Overload Bi-Metal MX	

GE

S.E.E.S. #	O.E.M. #	Description	Additional Description
GEC-001	CL07A311MJ	Contactor , GE AC Non-Reversing IEC Contactor, C2000 Series	

Furnas

S.E.E.S. #	O.E.M. #	Description	Additional Description
FNC-002	40HP32AA	Contact, 600V 90A 3Pole #3	120/240 VAC coil, 1 N.O. Aux
FNC-003	42BF25AF	Contact, 600V 30A 4Pole	120 VAC coil
FNC-005	14GP32AC81	Contact, 600V 60A 3Pole #2.5	120/240 VAC coil, 1 N.O. Aux/Overld
FNC-006	14FP32AC81	Contact, 600V 45A 3Pole #2	240/480 VAC coil, 1 N.O. Aux/Overld

Siemens

S.E.E.S. #	O.E.M. #	Description	Additional Description
SMC-001	3TF4422-OAK6	Contact, 600V 55A 3 Pole	120 VAC coil, 2 N.O./2 N.C. Aux
SMC-002	3TF50	Contact, 600V 160A 3 Pole	120 VAC coil, 2 N.O./2 N.C. Aux
SMC-003	3TF52	Contact, 600V 200A 3 Pole	120 VAC coil, 2 N.O./2 N.C. Aux
SMC-004	FRC-M18-AC120V	Contact, 600V 20A 3 Pole	120 VAC coil
SMC-005	42GE35AFX657	Contact, 90A 3 Pole	120 VAC coil
MIS-SC-011	3RT1015-1BB42	Contact, 24 VAC, 8A, 3 PNC, Din Rail	24 VAC coil
MIS-SC-011A	3RH1911-1FA22	Aux Contact Bld, 2 N.O. 2 N.C., Size S00 Front Mount Screw	
MIS-SC-011B	3RH1921-1DA11	Aux Contact Block, Siemens, 1 N.O. 1 N.C., 10mm, Screw Conn.	



Square D

S.E.E.S. #	O.E.M. #	Description	Additional Description
SQDC-001	8910DP12V02	Contact, 600V 20A 2 Pole	120 VAC coil, no aux.

Struthers Dunn

S.E.E.S. #	O.E.M. #	Description	Additional Description
SDC-001	A575KXX-AC220	Reversing Contact, 600V 15A 3 Pole	220 VAC coil

Telemecanique

S.E.E.S. #	O.E.M. #	Description	Additional Description
TMC-001	LC1-D0901M7	Contact, 600V 25A 3 Pole NEMA 2	220 VAC coil, 2 N.O./2 N.C. Aux
TMC-002	LC1-D1201	Contact, 600V 25A 3 Pole NEMA 3	208 VAC coil, 2 N.O./2 N.C. Aux
TMC-003	LC1-D18U7	Contact, 600V 35A 3 Pole NEMA 3	240 VAC coil, 2 N.O./2 N.C. Aux
TMC-004	LC1-DT40G7	Contact, 600V 40A 3 Pole NEMA 4	120 VAC coil, 2 N.O./2 N.C. Aux
TMC-005	LC1-D258G7	Contact, 600V 40A 3 Pole NEMA 2	120 VAC coil, 2 N.O./2 N.C. Aux
TMC-006	LC1-D25G7	Contact, 600V 40A 3 Pole NEMA 3	120 VAC coil, 2 N.O./2 N.C. Aux



TMC-002



TMC-003



TMC-006

Ward Leonard

S.E.E.S. #	O.E.M. #	Description	Additional Description
WLC-001	HDP9-11103	Contact, 600V 265A 3 Pole	With blow-out 1 N.O./1 N.C. Aux



Additional O.E.M. Contactors

Moeller

S.E.E.S. #	O.E.M. #	Description	Additional Description
MRC-001	DIL 00AM	Contactor, 600V 20A 3 Pole	120 VAC coil, 1 N.O. / 1 N.C. Aux

LCD

S.E.E.S. #	Description
LCD-3	Contactor, 125 VDC coil, 32A1 N.O. & 1 N.C. Aux Contacts

Door Contactor

S.E.E.S. #	O.E.M. #	Description
AZ-07	KTB-175-1	Door Contact, AZ 07, 1 N.O. 230 VAC @ 2A/ 200 VAC @ 2A

Coil

S.E.E.S. #	O.E.M. #	Description
JC-6A	KTB-175-1	Coil for Reversing Contactor, 120 VAC

Joslyn Clark



JC-9A



JC-9-KIT



S.E.E.S.#	O.E.M. #	Description
JC-9A	PLR240A	Phase Monitor 197-240V, Octal plug-in
JC-9-KIT	PLR240A	Phase Monitor Kit, 197-240V, NDS-8 Socket
JC-10A	PLR480A	Phase Monitor Assembly 440-480V, Octal plug-in
JC-10-KIT	PLR480A	Phase Monitor Kit, 440V Socket



JC-10



JC-10-KIT



S.E.E.S.#	O.E.M. #	Description
JC-1A	T230V032-86	Starter, Size 2, 200-208V
JC-1C	T13V033-86	Starter, Size 3, 200-208V



JC-8

S.E.E.S. #	O.E.M. #	Description
JC-8	KHP-C53527	Auxiliary Contact Assembly 1 N.O., 1 N.C.



JC-5



JC-2

S.E.E.S. #	O.E.M. #	Description
JC-2	TB-159-1-69001	Coil for #2 Starter, 110 VAC
JC-2A	TB-159-10	Coil for #2 Starter, 208 VAC
JC-2B	TB-159-269002	Coil for #2 Starter, 220-240 VAC
JC-2C	TB-162-7	Coil for #3 Starter, 110-120 VAC
JC-2D	TB-162-14	Coil for #3 Starter, 200-208 VAC
JC-2E	TB-162-8-69108	Coil for #3 Starter, 220-240 VAC

S.E.E.S. #	O.E.M. #	Description
JC-3A	K760, KTM311	Contact Kit, Size 00-0-1, 3 Pole
JC-3	K765, KTM321	Contact Kit, Size 2 Starter
JC-4	K770, KTM331	Contact Kit, Size 3 Starter



JC-3A

S.E.E.S. #	O.E.M. #	Heater Description
JC-5	2454, 62454	27.2 - 31.9 Amps
JC-5A	2455, 62455	32.0 - 35.9 Amps
JC-5B	2456, 62456	36.0 - 38.9 Amps
JC-5C	2467, 62457	39.0 - 40.0 Amps
JC-5D	2459, 62459	38.4 - 41.5 Amps
JC-5E	2528, 62528	39.2 - 42.3 Amps
JC-5F	2529, 62529	42.4 - 46.4 Amps
JC-5G	2530, 62530	46.5 - 50.8 Amps

Additional O.E.M. Contactors

Reversing Contactor

S.E.E.S.#	O.E.M. #	Description
PR-20	A275-KXX90	48 VDC 3 PDT Reversing Contactor for U.S. Elevator Door Control
PR-20A	275-KXX91	115 VAC 3 PDT Reversing Contactor
PR-20B	A275-KXX	240 VAC 3 PDT Reversing Contactor



PR-20



PR-20A

Kone Contactors

S.E.E.S.#	O.E.M. #	Description
KRP-200	520317	Contactor , 600 VAC, 3 N.O., 1 N.C., Boxed as Kit B
KRP-201	KM1337437	Auxiliary Block Contact , Front 2 N.O./2 N.C. Replaces US95322002
KRP-202	KM1337109 KM952444, US52951001	Contactor , 240 VAC, 4 N.O., 0N.C., R



PR-69B

General Motors

Control Relay

S.E.E.S.#	O.E.M. #	Description
PR-69B	RL4RA031TJ	Control Relay , 3 N.O. / 1 N.C., 120 VAC



ARO-S12

Aromat

Starters

Long-life Aromat starters have arc suppression especially for jogging duty, momentary voltage drop endurance and overload and phase loss protection.

S.E.E.S. #	O.E.M. #	Description	Voltage	Amp.
ARO-S1	F35U	Starter Size 1++	208	45
ARO-S2	F35U	Starter Size 1++	240	28
ARO-S11	F80U	Starter Size 3	480	80
ARO-S12	F85U	Starter Size 3+	208	95
ARO-S13	F85U	Starter Size 3+	240	95
ARO-S13A	F160U	Starter Size 4	120	165
ARO-S14	F160U	Starter Size 4	208	165
ARO-S15	F160U	Starter Size 4	240	165



ARO-S15

Coils

S.E.E.S. #	Coil Voltage For Relay	Type
ARO-C2	208 VAC	Size 1+, 2
ARO-C3	240 VAC	Size 1+, 2
ARO-C4	480 VAC	Size 1+, 2
ARO-C8	480 VAC	Size 2+, 3, 3+
ARO-C11	240 VAC	Size 4, 4+
ARO-C12	480 VAC	Size 4, 4+



ARO-01

Overload Relays

These relays offer phase loss protection and temperature compensation with an easy setting adjustment dial.

S.E.E.S. #	O.E.M. #	Description	Amperes
ARO-01	FT50U	Overload Relay Size 2	30-45



Motion Control



MOT-35-001



MOT-35-002



MOT-35-004



MOT-35-005



MOT-35-007

Contactors for Motion Control Systems

S.E.E.S. #	O.E.M. #	Description
MOT-35-001	35-72-CL25	22 Amp, 460 V, 120V Coil
MOT-35-002	35-72-CL45	34 Amp, 460 V, 120V Coil
MOT-35-003	35-72-CL04	32 Amp, 460 V, 120V Coil
MOT-35-004	35-72-CL06	48 Amp, 460 V, 120V Coil
MOT-35-005	35-72-CL07	62 Amp, 460 V, 120V Coil
MOT-35-006	35-72-CL08	68 Amp, 460 V, 120V Coil
MOT-35-007	35-72-CL09	80 Amp, 460 V, 120V Coil
MOT-35-008	35-72-CL10	96 AMP, 460 V, 120V Coil
MOT-35-009	35-72-CK75	140 Amp, 460 V, 120V Coil
MOT-35-010	35-72-CK08	156 Amp, 460 V, 120V Coil

Accessories for Contactors

S.E.E.S. #	O.E.M. #	Description
MOT-35-011	35-74-BEL02	Interlock
MOT-35-012	35-75-BCLF01	N.C. Auxiliary contact
MOT-35-013	35-75-BCLF10	N.O. Auxiliary contact
MOT-35-BCLL11	BCLL11	Aux contact Block, 1 N.O./1 N.C. for GE contactor



MOT-35-BCLL11



MOT-35-011



MOT-WH-5

Tach Wheel for Motion Control Systems

S.E.E.S. #	Description
MOT-WH-5	Tach Wheel for 1/2" shaft

Motion Control

Flex Couplings

S.E.E.S. #	Description
MOT-11-01-0021	Flex Coupling, 1/2" to 1/2" type 5802 Motion TACH-RE1-C
MOT-1195-0022	Flex Coupling, 5/16" x 3/8" Flex Type, Figure 8
MOT-1195-0023	Flex Tach Coupling, 5/16" to 5/16"



MOT-11-01-0021



MOT-1195-0022



MOT-1195-0023

Relays for Motion Control Systems

S.E.E.S. #	O.E.M. #	Description
MOT-27-003	27-01-0055	Motion Relay, # 27-01-0055 24VDC
MOT-27-01-0007	27-01-0007	Motion Relay, 48 VDC DPDT IC Type
MOT-27-08-001	27-08-0001	Motion Relay, Safety PCB 3 N.O. & 3 N.C. 110 VDC Coil
MOT-27-08-001A		PCB Relay Socket, for Motion Safety Relay MOT-27-08-001
MOT-27-08-0007	27-08-0007	Relay, Motion Control Safety 2 N.O. & 2 N.C. 110 VDC Plug-In
MOT-27-01-007A	AZ762-1C-12DE	Relay, Motion Mini Power, 12 VDC, SPDT, 16 Amps



MOT-27-08-001



MOT-27-01-0007

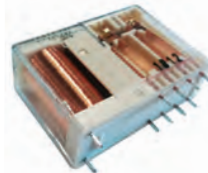

MOT-27-08-0007



MOT-27-08-0007A

Resistors for Motion Control Systems

S.E.E.S. #	O.E.M. #	Description
MOT-31-001	31-03-0017	Motion Resistor 10 OHM 200W fixed
MOT-31-002	31-03-0018	Motion Resistor 250 OHM 200W adjustable Use RES-59
MOT-31-003	31-03-0021	Motion Resistor 10 OHM 200W adjustable, Use RES-53

S.E.E.S. #	O.E.M. #	Description
MOT-33-0008		Diode, Zener 10 V, 1W
MIS-1101-0007	1101-0007	Encoder, M.C. 1024 CPR, shaft



MIS-1101-0007



MOT-31-001

PCB for Motion Control Systems

S.E.E.S. #	O.E.M. #	Description
MOT-PC-001	ICE-GR-2-T	PCBA Ice Rope Gripper, GEN 2 Tested



MOT-PC-001



Fans



MCE-001



MCE-002



MAGNA-FAN-001



MRP-50



MAGNA-FAN-002



MIS-901



MIS-901A



MIS-901B



MIS-901G



MIS-901AM



MIS-901R



SCF-1

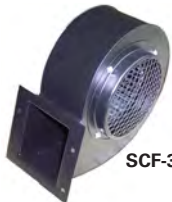

SCF-3

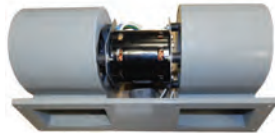

DMP-20



MIF-3



MIS-902



MIS-903



MIS-904



SCF-2

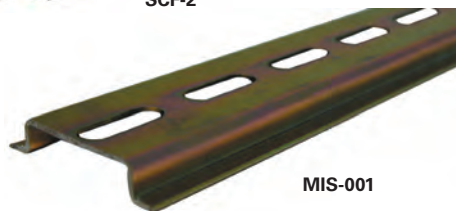

MIS-001

Fans for Controllers

S.E.E.S. #	O.E.M. #	Description
MCE-001	USP24255	Fan Kit, for Miprom Cabinet 115V 105CFM Tubeaxial fan
MCE-002		Fan Kit, Axial, 120 x 38mm, 240 VDC wire
MAGNA-FAN-001		Magnetek Kit
MAGNA-FAN-002	HPV9FAN1A	Magnetek Kit
MRP-50	US90507	Fan, 127 CFM 230 VAC 50/60 hz enclosed 4-1/2" SQ.

Fans & Fan Components

S.E.E.S. #	O.E.M. #	Description
MIS-901		Exhaust Fan, 2 speed, round, 120V, 10" OD. Fan motors are sealed, self lubricating and rubber mounted to housing for quiet dependable service
MIS-901A		Exhaust Fan, one or two speed exhaust fan 10" Sq.
MIS-901B		Exhaust Fan, 2 speed, round, Low Profile 12" D 5" deep for cab
MIS-901C		Exhaust Fan, Two speed with adaptor (up to 15")
MIS-901E		Exhaust Fan, 3 Speed Enclosed For High speed Elev 400CFM Flow
MIS-901F		Exhaust Fan, Dual 3 Spd 120VAC High Spd Elev 800CFM Air Flow
MIS-901G	XF12VDC	Exhaust Fan, 12V Emergency Backup Operates At 80 Degrees On 6 VDC
MIS-901H	NYPS-4	Power Supply, Emergency Exh 2hrs Of Power, Used with MIS-901G
MIS-901J	NYPS-8	Power Supply, Emergency Exh 4hrs Of Power, Used with MIS-901G
MIS-901AM		Motor, replacement fan for MIS-901A
MIS-901R	9853194	Fan, Rotron fan rack mount 5.22" H 19" W x 13.70" Deep
MIS-902		Adapter for exhaust fan. Allows installation of todays high performance fan models to replace older, larger diameter units. Adapter plate measures 15" square with 10" diameter mounting hole.
MIS-903		Grill for exhaust fan. White enamel 14" O.D. for MIS-901 fans. Heavy duty welded steel.
MIS-904		Grill for exhaust fan. Chrome - #4 stainless steel 14" O.D. for MIS-901 fans. Heavy duty welded steel delivers high performance with low air flow restriction.
DMP-20	378AT2	Fan / Blower, extremely quiet, rugged construction. 115VAC 550 CFM capacity, for mounting in any position, for Dover VVF Equipment
MIF-3	ZQF-330	Fan, Mitsubishi ZQF-330
SCF-1	142984	Fan, for RV140 380-400V
SCF-2		Fan, for VF140, 100/220/230V, 50/60HZ, 30 Watts
SCF-3		Fan, for VF140, 220VAC, 50/60HZ, 40 Watts

Din Rails Mounting Rail Kits

S.E.E.S. #	Description
MIS-001	6" 35mm Rail Kit
MIS-002	5" 35mm Rail Kit
MIS-003	4" 35mm Rail Kit
MIS-004	3" 35mm Rail Kit
MIS-005	Din Rail Kit, 39" Lg (1m) 35mm D Rail with Mounting hardware

Resistors

25 Watt Adjustable Resistors

S.E.E.S. #	Resistance	S.E.E.S. #	Resistance
RES-1	5 Ohms	RES-8	750 Ohms
RES-2	10 Ohms	RES-9	1000 Ohms
RES-3	25 Ohms	RES-9A	1250 Ohms
RES-4	50 Ohms	RES-10	1500 Ohms
RES-5	100 Ohms	RES-11	2000 Ohms
RES-5A	150 Ohms	RES-12	3000 Ohms
RES-6	250 Ohms	RES-13	5000 Ohms
RES-7	500 Ohms		

50 Watt Adjustable Resistors

S.E.E.S. #	Resistance	S.E.E.S. #	Resistance
RES-14	1 Ohms	RES-24	500 Ohms
RES-15	5 Ohms	RES-25	1000 Ohms
RES-16	20 Ohms	RES-26	1500 Ohms
RES-17	25 Ohms	RES-27	2000 Ohms
RES-18	50 Ohms	RES-28	2500 Ohms
RES-19	75 Ohms	RES-32A	8000 Ohms
RES-20	100 Ohms	RES-30	30 K Ohms
RES-21	200 Ohms	RES-31	40 K Ohms
RES-22	250 Ohms	RES-32	50 K Ohms
RES-23	400 Ohms		

100 Watt Adjustable Resistors

S.E.E.S. #	Resistance	S.E.E.S. #	Resistance
RES-33	1 Ohm	RES-42	500 Ohms
RES-34	2 Ohms	RES-43	750 Ohms
RES-35	5 Ohms	RES-44	1000 Ohms
RES-36	10 Ohms	RES-45	2500 Ohms
RES-37	25 Ohms	RES-46	5000 Ohms
RES-38	50 Ohms	RES-47	10000 Ohms
RES-39	100 Ohms	RES-48	20000 Ohms
RES-40	250 Ohms	RES-49	40000 Ohms
RES-41	300 Ohms	RES-49A	8 Ohms

150 Watt Fixed Resistor

S.E.E.S. #	Resistance
RES-49A	8 Ohms

200 Watt Adjustable Resistors

S.E.E.S. #	Resistance	S.E.E.S. #	Resistance
RES-50	1 Ohm	RES-58	200 Ohms
RES-51	2 Ohms	RES-59	250 Ohms
RES-51B	4 Ohms	RES-59A	300 Ohms
RES-52	5 Ohms	RES-60	500 Ohms
RES-53	10 Ohms	RES-60A	750 Ohms
RES-53A	15 Ohms	RES-61	1000 Ohms
RES-53B	20 Ohms	RES-61A	1500 Ohms
RES-54	25 Ohms	RES-61B	2000 Ohms
RES-55	50 Ohms	RES-62	2500 Ohms
RES-55A	75 Ohms	RES-63	5000 Ohms
RES-56	100 Ohms	RES-65	50000 Ohms
RES-57	150 Ohms		

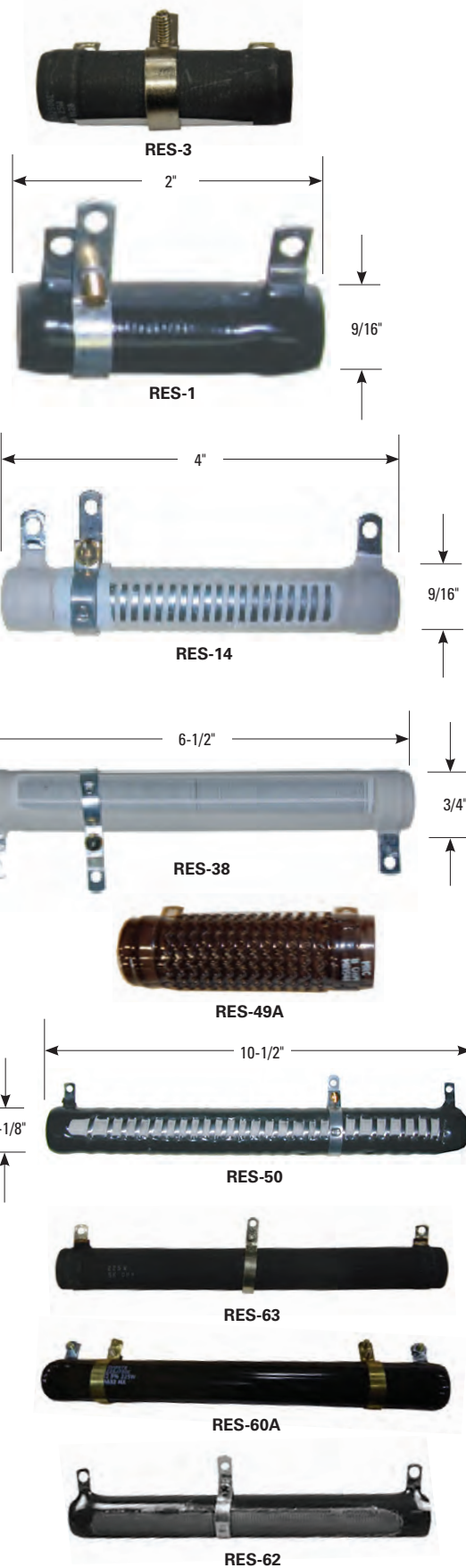



Resistors

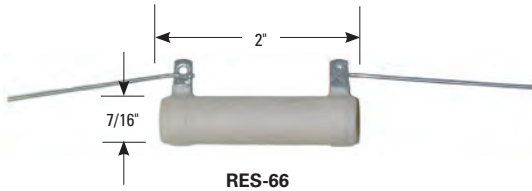

RES-66



RES-66



RES-68



RES-81A

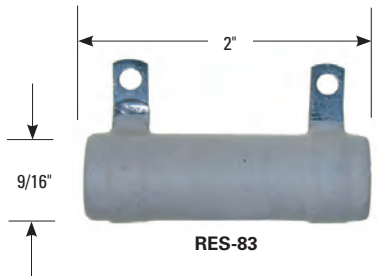

RES-83



RES-94



RES-90



RES-95

20 Watt Fixed Resistors With Wire Leads

S.E.E.S. #	Resistance	S.E.E.S. #	Resistance
RES-66	10 Ohms	RES-72	1000 Ohms
RES-67	50 Ohms	RES-73	1500 Ohms
RES-68	100 Ohms	RES-74	2000 Ohms
RES-69	150 Ohms	RES-75	2500 Ohms
RES-70	250 Ohms	RES-75A	4000 Ohms
RES-70A	300 Ohms	RES-76	7500 Ohms
RES-71	500 Ohms	RES-77	10000 Ohms

25 Watt Fixed Resistors

S.E.E.S. #	Resistance
RES-83	750 Ohms
RES-78	1000 Ohms
RES-79	2000 Ohms
RES-81	5000 Ohms
RES-81A	7500 Ohms
RES-82	25000 Ohms

300 Watt (Fixed) Resistor

S.E.E.S. #	Resistance
RES-84	.05 Ohms, chassis mount

Mounting Brackets for Resistors

S.E.E.S. #	Description
RES-90	Bracket for 12-20 Watt Resistors
RES-91	Bracket for 25-50 Watt Resistors
RES-92	Bracket for 100 Watt Resistors
RES-93	Bracket for 200 Watt Resistors
RES-94	Slider Band, for 1-1/8" Resistors
RES-95	Bolt and washer kit, 200-225 watt Res mounting

FIXTURE AND CAB

QUICK LOCATOR GUIDE

Car and Hall Accessories	356
Bulletin Boards and Certificate Frames	356
Mirrors, Pad Hooks, and Key Boxes	357
Car Operating Panels Car and Hall	315
Emergency Telephones	325-328
Innovation	317-319, 336-339
Emergency Lights	317-318
EPCO Emergency Lights	318
PC Boards for Pushbutton	337
Position Indicators, Digital	317
Keys	358-359
Key Switches	342-355
EPCO	345
Fire Service	346-355
Innovation	345
OEM	343-344
SEES	342
Pushbuttons	330-341
SEES Fixtures	313-317
SEES Line Alert	328-329
SEES Pushbuttons	333-335
Signal Components	340-341



ALPHA TAGS



Application

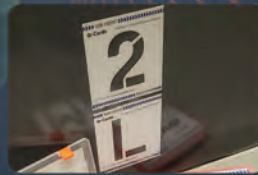
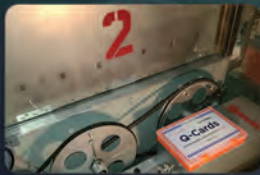

MAGNETIC ALPHA-NUMERIC STENCILS

CREATE A CLEAN, BEAUTIFUL LANDING MARKING FOR THAT FINISHING TOUCH ON A WELL BUILT ELEVATOR

DON'T DO ANOTHER JOB WITHOUT ALPHA TAGS



Convenient & Simple

Easily slap on the magnet and with spray paint or a large felt pen, safely mark your landings or equipment.



Easily transported

Stencils come in a compact hard-shell carrying case for safekeeping.



Better than Paper

No more fumbling around with paper stencils as tape, these stencils allow for a faster hoistway marking experience and professional looking finish.



Kerning Gauge

A kerning gauge is included for uniform gaps between characters.

SEES Part#: Q-CARDS

**CODE
COMPLIANT**

**4.5" TEXT SIZE
MEETS 2.9 ID
REQUIREMENTS**

Always Smooth Sailing



SOUTHERN ELEVATOR
& ELECTRIC SUPPLY



SEES Inc



SEESParts

2781 West McNab Rd, Pompano Beach, FL 33069 • (800) 526-0026 • www.SEESinc.com

SEES Fixtures

COP (Car Operating Panel)

S.E.E.S. #	Description
SEES-FCOP-00X-AP	SEES Fixture COP, "X" Stops Applied Panel
SEES-FCOP-00X-AP-PW	SEES Fixture COP, "X" Stops Applied Panel, Pre-Wired
SEES-FCOP-00X-DIR	SEES Fixture COP, "X" Stops Dover Impulse Retrofit
SEES-FCOP-00X-DIR-PW	SEES Fixture COP, "X" Stops Dover Impulse Retrofit Pre-Wired
SEES-FCOP-00X-330A	SEES Fixture COP, "X" Stops Schindler 330A Retrofit
SEES-FCOP-00X-330A-PW	SEES Fixture COP, "X" Stops Schindler 330A Retrofit Pre-Wired
SEES-FCOP-00X-SP	SEES Fixture COP, "X" Stops Swing Panel
SEES-FCOP-00X-SP-PW	SEES Fixture COP, "X" Stops Swing Panel, Pre-Wired
SEES-FCOP-00X-OR	SEES Fixture COP, "X" Stops Otis Canoe Retrofit
SEES-FCOP-00X-OR-PW	SEES Fixture COP, "X" Stops Otis Canoe Retrofit, Pre-Wired

Request quote for more than 8 stops.

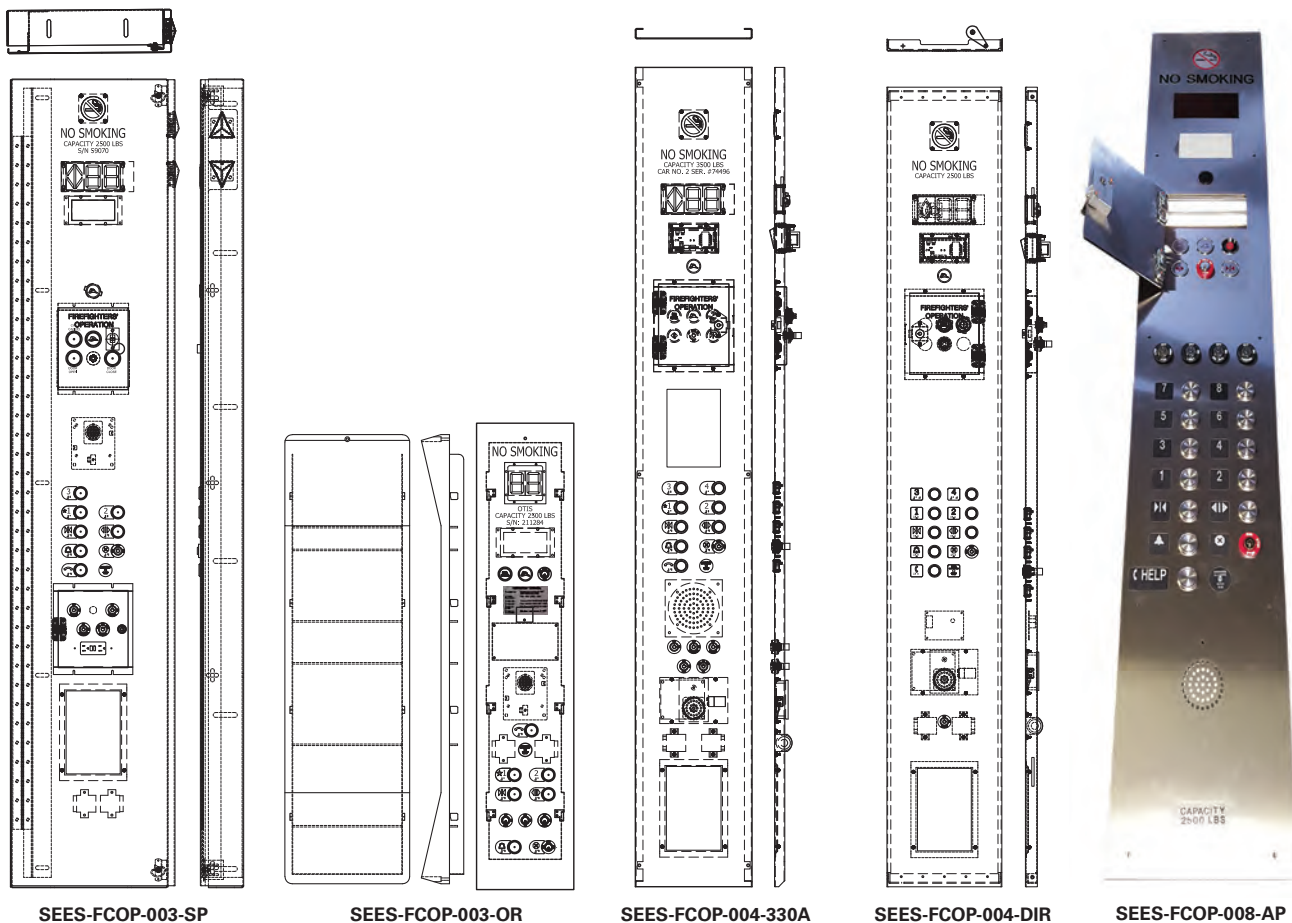

SEES Fixtures

COP

S.E.E.S. #	Description
SEES-FCOP-SW-002A	SEES COP Stop Switch, Toggle DPST
SEES-FCP-330A	SEES Fixture Cover Plate, for Old 330A Hall Plates
SEES-FFKB-FM-001	SEES Fixture Fire, Key Box Flush Mount Specify Key
SEES-FFLP-FM-001	SEES Fixture Fire, Lobby Panel Flush Mount

Request quote for more than 8 stops.

HOP - Surface Mount

S.E.E.S. #	Description
SEES-FHOP-SMI-001	SEES Fixture HOP, Surface Mount Intermediate
SEES-FHOP-SMI-001-PW	SEES Fixture HOP, Surface Mount Intermediate Pre-Wired
SEES-FHOP-SMT-001	SEES Fixture HOP, Surface Mount Terminal First Floor
SEES-FHOP-SMT-001-PW	SEES Fixture HOP, Surface Mount Terminal First Floor, Pre-Wired
SEES-FHOP-SMT-002	SEES Fixture HOP, Surface Mount Terminal Top Floor
SEES-FHOP-SMT-002-PW	SEES Fixture HOP, Surface Mount Terminal Top Floor, Pre-Wired
SEES-FHOP-SMT-003	SEES Fixture HOP, Surface Mount Terminal Bottom, Non-Egress Floor
SEES-FHOP-SMT-003-PW	SEES Fixture HOP, Surface Mount Terminal Bottom, Non-Egress Floor, Pre-Wired
SEES-FHOP-SMT-101	SEES Fixture HOP, Surface Mount Terminal, SQ Braille, PB-10-B Button, PLV (Rath), Fire Serv (FEO)
SEES-FHOP-SMT-102	SEES Fixture HOP, Surface Mount Terminal, SQ Braille, PB-10-B Button, PLV (Rath), Fire Serv (FEO), Blue Pos Ind.
SEES-FHOP-SMT-103	SEES Fixture HOP, Surface Mount Terminal, SQ Braille PB-10-B Button, PLV (Rath), Fire Serv (FEO), Blue Pos Ind., Access
SEES-FHOP-SMT-104	SEES Fixture HOP, Surface Mount Terminal, SQ Braille, PB-10-B Button, PLV (Rath), Fire Serv (FEO), Access
SEES-FHOP-SMT-201	SEES Fixture HOP, Surface Mount Top Terminal, SQ Braille, PB-10-B Button
SEES-FHOP-SMT-202	SEES Fixture HOP Surface Mount Top Terminal, SQ Braille, PB-10-B Button, Blue Pos Ind.
SEES-FHOP-SMT-203	SEES Fixture HOP Surface Mount Top Terminal, SQ Braille, PB-10-B Button, Blue Pos Ind., Access
SEES-FHOP-SMT-204	SEES Fixture HOP Surface Mount Top Terminal, SQ Braille, PB-10-B Button, Access
SEES-FHOP-SMT-301	SEES Fixture HOP Surface Mount Bottom Terminal, SQ Braille, PB-10-B Button
SEES-FHOP-SMT-302	SEES Fixture HOP Surface Mount Bottom Terminal, SQ Braille, PB-10-B Button, Blue Pos Ind.
SEES-FHOP-SMT-303	SEES Fixture HOP Surface Mount Bottom Terminal, SQ Braille, PB-10-B Button, Blue Pos Ind., Access
SEES-FHOP-SMT-304	SEES Fixture HOP Surface Mount Bottom Terminal, SQ Braille, PB-10-B Button, Access
SEES-FHOP-SMI-101	SEES Fixture HOP Surface Mount Intermediate, SQ Braille, PB-10-B Button
SEES-FHOP-SMI-102	SEES Fixture HOP Surface Mount Intermediate, SQ Braille, PB-10-B Button, Blue Pos Ind.



SEES-FHOP-SMI-001



SEES-FHOP-SMT-001

HOP - Flush Mount

S.E.E.S. #	Description
SEES-FHOP-FMI-001	SEES Fixture HOP, Flush Mount Intermediate Double Button
SEES-FHOP-FMI-001-PW	SEES Fixture HOP, Flush Mount Intermediate Double Button, Pre-Wired
SEES-FHOP-FMI-002	SEES Fixture HOP, Surface Mount Intermediate 2 Buttons Only
SEES-FHOP-FMI-002-PW	SEES Fixture HOP, Surface Mount Intermediate 2 Buttons Only, Pre-Wired
SEES-FHOP-FMT-001	SEES Fixture HOP, Flush Mount Terminal Single Button, First Floor
SEES-FHOP-FMT-001-PW	SEES Fixture HOP, Flush Mount Terminal Single Button, First Floor, Pre-Wired
SEES-FHOP-FMT-002	SEES Fixture HOP, Flush Mount Terminal Single Button
SEES-FHOP-FMT-002-PW	SEES Fixture HOP, Flush Mount Terminal Single Button, Pre-Wired
SEES-FHOP-FMT-003	SEES Fixture HOP, Flush Mount Terminal Bottom, Single Button, Non-Egress
SEES-FHOP-FMT-003-PW	SEES Fixture HOP, Flush Mount Terminal Bottom, Single Button, Non-Egress, Pre-Wired

Car Operating Panels Car and Hall

Ultra Slim HOP

S.E.E.S. #	Description
SM-HOP-001	Ultra Slim HOP, 1 Soft Touch PB with LCD Display, Anti Exp Glass
SM-COP-002	Ultra Slim COP, 2 Stop with LCD 6mm Anti Explosion Glass
SM-HOP-002	Ultra Slim HOP, 2 Soft Touch PB with LCD Display, Anti Exp Glass
SM-COP-003	Ultra Slim COP, 3 Stop with LCD 6mm Anti Explosion Glass
SM-COP-004	Ultra Slim HOP, 2 Soft Touch PB with LCD Display, Anti Exp Glass
SEES-FHOP-SMT-001TB	SEES Fixture HOP, Surface Mount Terminal Thin 310mm x 100mm x 20mm, Blue Metal Button
SEES-FHOP-SMT-001TR	SEES Fixture HOP, Surface Mount Terminal Thin 310mm x 100mm x 20mm, Red Metal Button
SEES-FHOP-SMT-001TW	SEES Fixture HOP, Surface Mount Terminal Thin 310mm x 100mm x 20mm, White Metal Button
SEES-FHOP-SMI-001TR	SEES Fixture HOP, Surface Mount Intermediate Thin 310mm x 100mm x 20mm, Red Metal Button
SEES-FHOP-SMI-001TB	SEES Fixture HOP, Surface Mount Intermediate Thin 310mm x 100mm x 20mm, Blue Metal Button
SEES-FHOP-SMI-001TW	SEES Fixture HOP, Surface Mount Intermediate Thin 310mm x 100mm x 20mm, White Metal Button



SEES-FHOP-SMT-001TB



SEES-FHOP-SMT-001TR

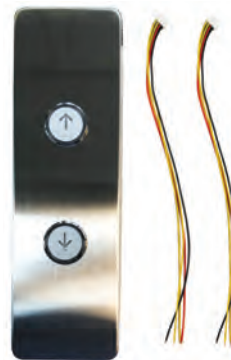

SEES-FHOP-SMI-001TB



SEES-FHOP-SMI-001TW

SEES Fixtures

Service Panel

S.E.E.S. #	Description
SEES-FHAP-FMT-001	SEES Fixture Hall Access Panel, Flush Mount
SEES-FFSP-FMT-001	SEES Fixture Fire Service Panel, Flush Mount
SEES-FPTBS-FM-001	SEES Fixture Photoelectric Tube Bypass Switch, Flush mount

Lantern Stations & Arrows

S.E.E.S. #	Description
SEES-LLA-001B	SEES LED Lantern Arrow, 24-48V / 120V, Blue Color
SEES-LLA-001G	SEES LED Lantern Arrow, 24-48V / 120V, Green Color
SEES-LLA-001R	SEES LED Lantern Arrow, 24-48V / 120V, Red Color
SEES-LLA-001W	SEES LED Lantern Arrow, 24-48V / 120V, White Color
SEES-FCLS-FM-001	SEES Fixture Car Lantern Station, Flush Mount
SEES-FCLS-FM-001-330A	SEES Fixture Car Lantern Station, Flush 330A Standard Up/Dn Arrow
SEES-FCLS-FM-001-OR	SEES Fixture Car Lantern Station, Flush Mount, Up/Dn Vandal Arrows for Otis Retrofit
SEES-FCLS-FM-002	SEES Fixture Car Lantern Station, Flush Mount Projecting Arrow, White 24V, 100mm x 280mm
SEES-FCLS-FM-003	SEES Fixture Car Lantern Station, Flush Mount Projecting Round Arrow, White 24V, 100mm x 290mm
SEES-FHLS-FMI-001	SEES Fixture Hall Lantern Station, Flush Mount, Terminal
SEES-FHLS-FMI-002	SEES Fixture Hall Lantern Station, Flush Mount, Intermediate
SEES-FHLS-SM-001	SEES Fixture Hall Lantern Station, Surface Mount
SEES-FCLS-FMT-001	SEES Fixture Hall Lantern Station, Flush Mount, Terminal (1) Arrow
SEES-FCLS-FMT-002	SEES Fixture Hall Lantern Station, Flush Mount
SEES-FCLS-SM-001	SEES Fixture Car Lantern Station, Surface Mount



SEES-LLA-001G



SEES-LLA-001R

SEES Fixtures

Hall Position Indicator

S.E.E.S. #	Description
SEES-FHPI-FM-001-330A	SEES Fixture Hall Position Indicator, Flush 330A
SEES-FHPI-FMT-001	SEES Fixture Hall Position Indicator, Flush Mount, Terminal w/ PI & 2 Arrows
SEES-FHPI-FMT-002	SEES Fixture Hall Position Indicator, Flush Mount, w/ PI Only
SEES-FHPI-FMT-003	SEES Fixture Hall Position Indicator, Flush Mount, Terminal Discrete
SEES-FHPI-SMI-001	SEES Fixture Hall Lantern Station, Surface Mount, Intermediate
SEES-FHPI-SMT-001	SEES Fixture Hall Position Indicator, Surface Mount, Terminal



SEES-PI-D05AV-BBB



SEES-PI-D05AV-RRR



SEES-PI-D10AV-BBB



SEES-PI-S10AV-BBB



SEES-PI-S10AV-RRR



SEES-PI-GONG-001

SEES Position Indicators

S.E.E.S. #	O.E.M. #	Description
SEES-PI-CCB-L		Position Indicator, COP Double Char with Arrow
SEES-PI-D05AV-BBB	MV105-BBB	Position Indicator, Double 0.5" Blue Character, Blue Arrows, Blue Lens, Vertical Mount
SEES-PI-D05AV-RRR	MV105-RRR	Position Indicator, Double 0.5" Red Character, Red Arrows, Red Lens, Vertical Mount
SEES-PI-D10AV-RRR	MSV21-RRR	Position Indicator, Double 1.0" Red Character, Red Arrows, Red Lens, Vertical Mount
SEES-PI-S10AV-WWW	MSV11-WWW	Position Indicator, Single 1.0" Blue Character, White Arrows, White Lens, Vertical Mount
SEES-PI-D10AV-BBB	MSV21-BBB	Position Indicator, Double 1.0" Blue Character, Red Arrows, Red Lens, Vertical Mount
SEES-PI-D10AH-RRR	MH210-RRR	Position Indicator, Double 1.0" Red Character, Red Arrows, Red Lens, Horizontal Mount
SEES-PI-D22AH-RRR	MH222-RRR	Position Indicator, Double 2.2" Red Character, Blue Arrows, Blue Lens, Horizontal Mount
SEES-PI-D22AH-BBB	MH222-BBB	Position Indicator, Double 2.2" Blue Character, Blue Arrows, Blue Lens, Horizontal Mount
SEES-PI-D22AH-GGG	MH222-GGG	Position Indicator, Double 2.2" Green Character, Green Arrows, Grey Lens, Horizontal Mount
SEES-PI-D22AH-WWW	MH222-WWW	Position Indicator, Double 2.2" White Character, White Arrows, White Lens, Horizontal Mount
SEES-PI-S10AV-BBB	MSV11-BBB	Position Indicator, 1.0" Blue Character, Blue Arrows, Blue Lens, Vertical Mount
SEES-PI-S10AV-RRR	MSV11-RRR	Position Indicator, Single 1.0" Red Character, Red Arrows, Red Lens, Vertical Mount
SEES-PI-S22AH-BBB	MH122A-BBB	Position Indicator, Single 2.2" Blue Character, Blue Arrows, Blue Lens, Horizontal Mount
SEES-PI-S22AH-RRR	MH122A-RRR	Position Indicator, Single 2.2" Red Character, Red Arrows, Red Lens, Horizontal Mount
SEES-PI-SA130-VMABB	SA130-VMABB	ADA Arrow, Vertical Micro-Comm, Blue Arrival Signal



SEES-PI-D22AH-BBB



SEES-PI-D22AH-RRR



SEES-PI-S22AH-RRR



SEES-PI-PCB-001

SEES Position Indicator Parts

S.E.E.S. #	O.E.M. #	Description
SEES-PI-ARROW-001A		PI Hall Station Arrow, 120V Amber
SEES-PI-ARROW-001R		PI Hall Station Arrow, 120V Red
SEES-PI-EPSL-001		Slimlite Emergency Light, 12V, 6" x 1"
SEES-PI-PCB-001	MPCB1	Position Indicator Passing Chime Board, 4 Wire Connect to PI
SEES-PI-GONG-001	M3491-1	Arrival Gong, LED Driver with Chime 24V
SEES-PI-GONG-002	SGOMV-B2	Handicap Gong, Pos & Neg 24-120AC/DC
SEES-PI-HCB-L		Position Indicator, Hall Double Char with Arrow Segmented 2.12 x 3.62 Display Area
SEES-PI-DVA-VM3541	VM3541-MMBL	PI Digitized Voice Annunciator, Micro Comm Local Speaker w/ box
SEES-PI-DVA-VS3541	VS3541-B1BL	PI Digitized Voice Annunciator, Discrete Pos 24-48 AC/DC, Local Speaker with Box, 110 AC Transformer
SEES-PI-SMCDU-B2B	SMCDU-B2B	Display Driver Board, with Box 4 Display Capability Pos 24-48 VDC, 48 VAC, Binary Format
SEES-PI-9VOICE-SPKB	9VOICESPKB	Voice Speaker Box, for Position Indicator 48 VAC, Binary Format



SEES-PI-GONG-002



SEES-PI-9VOICE-SPKB

INNOVATION

Emergency Light

S.E.E.S. #	Description
INEL-001	Emergency light, for Innovation COP III LED Light, 120 VAC uses battery MIS-194Q
MIS-194Q	Battery, replacement for INEL-001

See more replacement batteries on pages 270-271.



INEL-001



INPI-002

Position Indicators, Digital

S.E.E.S. #	Description
INPI-002	Digital PI for Innovation, style IH320-XXXC 120 VAC
INPI-002-FL14	Digital PI for Innovation, style IH320-XXXC 120 VAC, Floors 1, 2, 3, 4
INPI-003	Digital PI for Innovation style IH320-XXXF 24-48 VDC with negative signal
INPI-004	Digital PI for Innovation, Display MH210-RRX
INPI-004A	Digital PI for Innovation, Driver SMCDU-C2B
INPI-005-SP	Digital PI for Innovation, Driver, Special, No Box Specify, Voltage, Signal and Floor Designations
VMI-PI-024L	Position Indicator, PDU-8400 24V with Lens
VMI-PI-120L	Position Indicator, PDU-8400 120V with Lens
INPC-001E	Display Driver Board, 24DC Neg. Line/Floor, No Box

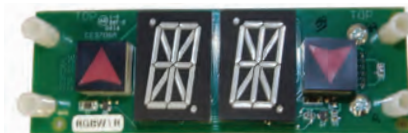

INPI-004



INPI-004A



INPI-005



Emergency Lights

S.E.E.S. #	O.E.M. #	Description
ELU-4	ELU-4	Emergency Light , Mini-Fluorescent light
GB-200		Emergency Light Lens , white molded plastic, 6-1/2" x 3-1/4" replacement lens for GB-201
GB-201		Emergency Light Lens , EL-2, EL-4 w/ battery, uses MIS-194I battery
GB-201-PCB		Emergency Light Lens , PCB Only for Emerg Light Pack
GB-201B		Emergency Light , with LED Board
GB-201C		PCB , LED for Emergency Light
MIS-194A		Emergency Light , self contained, tamper resistant, easily installed surface mounts above or near car station, 120V, stainless steel, 10" x 5-3/8" x 1-3/4" with white frosted durable plastic lens. Uses MIS-194 battery. Uses ML-30 and ML-31 Lamps. Battery and lamps included.
MIS-194AL		Replacement Lens , for Emergency Light, 5.1" x 9.4", white frosted durable plastic
MIS-194L		Emergency Light , self contained, tamper resistant, easily installed surface mounts above or near car station, 120V, stainless steel, 9-3/4" x 5-1/4" x 2" with white frosted durable plastic lens
MIS-294A	ELK01	Emergency Light , Universal Kit LED, Battery, Pcb & Hardware
MIS-294B	ELK02	Emergency Light , Dover & TKE LED, Battery, Pcb & Hardware
MIS-907		Slimline Emergency Light , Car top power supply with attached alarm bell and remote slimline fixture. Easily installed, proven reliable for years of maintenance free operation. Uses ML-30 lamps. 120V primary, 6V secondary.
MIS-907A		Replacement Light , SlimlineFor MIS-907
MIS-907B		Mon-ELight Kit , MES964B
NP24-12B		Battery , 12V
SEES-EML-001		Emergency Light Board , 120/220V Input, 12V LED, 6/12V Bell Output
SEES-EML-002		Emergency Light Board , 120V Input, 6/12V LED, 6/12V Bell Output
SEES-EML-003		Emergency Light Board , 120/240V Input, 6/12V Bell, 6 LED Sub Board
SEES-EML-004		Emergency Light , Rectangular Projecting Lens



MIS-194A



MIS-194L



MIS-294A



MIS-294B



MIS-907



MIS-907B



NP24-12B

EPCO Emergency Lights

S.E.E.S. #	O.E.M. #	Description
1001-22-00	1001-22-00	Light Fixture , CSM 12V light
1001-43-00	1001-43-00	Light Fixture , CSM 6V light
1002-22-00	1002-22-00	Light Fixture , WRM 12V light
1002-43-00	1002-43-00	Light Fixture , WRM 6V light
1003-22-00	1003-22-00	Light Fixture , WSM 12V light
1003-43-00	1003-43-00	Light Fixture , WSM 6V light
1006-33-00	1006-33-00	Light Fixture , SBF 6V light
1009-11-00-S	1009-11-00-S	Light Fixture , NSMS Nicad Self-Contained light



1002-43-00



1003-43-00



1009-11-00-S

See pages 370-371 for complete listing of replacement batteries.

Cab Ceiling

Replacement panels manufactured to strict standards to meet code compliance for elevator industry use.

S.E.E.S. #	Description
SEES-RLB-A	Cab Ceiling , replacement panel, 2 x 4, white, light diffuser for cab ceiling fluorescent type light fixture
SEES-RLB-B	Egg Crate Cab Ceiling , replacement panel, 2 x 4, brushed chrome finish for fluorescent type light fixture

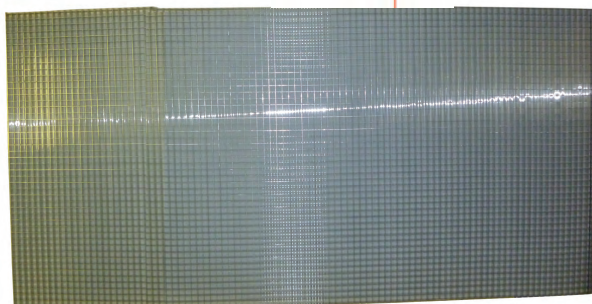
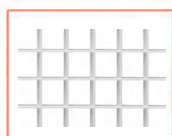

SEES-RLB-B



SEES-RLB-A

Cab Decoration

S.E.E.S. #	Description
SEES-INTERIOR-001	Cab Decoration/Interior , SS Wood and Plastic Laminate



2781 W. McNab Rd.
 Pompano Beach, FL 33069
 Phone: 800.526.0026

FIXTURE RFQ - PROJECT OVERVIEW

Project/Building Name _____ Customer _____
 City/State _____ Contact Name _____
 Customer Ref #. _____ Contact # _____

New Construction Mod Fixtures Only Controller Type _____ Voltage _____
 Specification Attached Mod Fixtures/Cab COP Pre-Wired Hall Fixtures Pre-Wired

COP SUMMARY & FLOOR BUTTON RISER CHART

Please fill in Floor markings at EACH landing and indicate if it is a Front or Rear Opening

COP Details are to be completed on Page 2

Car #						
Capacity #						
Installation						
Type (Pass/Freight)						
Serial / State ID						

Floor Marking

LANDING	FRONT	REAR	F	R	F	R	F	R	F	R	F	R	F	R
23	_____	_____	<input type="checkbox"/>	<input type="checkbox"/>	<input type="checkbox"/>	<input type="checkbox"/>	<input type="checkbox"/>	<input type="checkbox"/>	<input type="checkbox"/>	<input type="checkbox"/>	<input type="checkbox"/>	<input type="checkbox"/>	<input type="checkbox"/>	<input type="checkbox"/>
22	_____	_____	<input type="checkbox"/>	<input type="checkbox"/>	<input type="checkbox"/>	<input type="checkbox"/>	<input type="checkbox"/>	<input type="checkbox"/>	<input type="checkbox"/>	<input type="checkbox"/>	<input type="checkbox"/>	<input type="checkbox"/>	<input type="checkbox"/>	<input type="checkbox"/>
21	_____	_____	<input type="checkbox"/>	<input type="checkbox"/>	<input type="checkbox"/>	<input type="checkbox"/>	<input type="checkbox"/>	<input type="checkbox"/>	<input type="checkbox"/>	<input type="checkbox"/>	<input type="checkbox"/>	<input type="checkbox"/>	<input type="checkbox"/>	<input type="checkbox"/>
20	_____	_____	<input type="checkbox"/>	<input type="checkbox"/>	<input type="checkbox"/>	<input type="checkbox"/>	<input type="checkbox"/>	<input type="checkbox"/>	<input type="checkbox"/>	<input type="checkbox"/>	<input type="checkbox"/>	<input type="checkbox"/>	<input type="checkbox"/>	<input type="checkbox"/>
19	_____	_____	<input type="checkbox"/>	<input type="checkbox"/>	<input type="checkbox"/>	<input type="checkbox"/>	<input type="checkbox"/>	<input type="checkbox"/>	<input type="checkbox"/>	<input type="checkbox"/>	<input type="checkbox"/>	<input type="checkbox"/>	<input type="checkbox"/>	<input type="checkbox"/>
18	_____	_____	<input type="checkbox"/>	<input type="checkbox"/>	<input type="checkbox"/>	<input type="checkbox"/>	<input type="checkbox"/>	<input type="checkbox"/>	<input type="checkbox"/>	<input type="checkbox"/>	<input type="checkbox"/>	<input type="checkbox"/>	<input type="checkbox"/>	<input type="checkbox"/>
17	_____	_____	<input type="checkbox"/>	<input type="checkbox"/>	<input type="checkbox"/>	<input type="checkbox"/>	<input type="checkbox"/>	<input type="checkbox"/>	<input type="checkbox"/>	<input type="checkbox"/>	<input type="checkbox"/>	<input type="checkbox"/>	<input type="checkbox"/>	<input type="checkbox"/>
16	_____	_____	<input type="checkbox"/>	<input type="checkbox"/>	<input type="checkbox"/>	<input type="checkbox"/>	<input type="checkbox"/>	<input type="checkbox"/>	<input type="checkbox"/>	<input type="checkbox"/>	<input type="checkbox"/>	<input type="checkbox"/>	<input type="checkbox"/>	<input type="checkbox"/>
15	_____	_____	<input type="checkbox"/>	<input type="checkbox"/>	<input type="checkbox"/>	<input type="checkbox"/>	<input type="checkbox"/>	<input type="checkbox"/>	<input type="checkbox"/>	<input type="checkbox"/>	<input type="checkbox"/>	<input type="checkbox"/>	<input type="checkbox"/>	<input type="checkbox"/>
14	_____	_____	<input type="checkbox"/>	<input type="checkbox"/>	<input type="checkbox"/>	<input type="checkbox"/>	<input type="checkbox"/>	<input type="checkbox"/>	<input type="checkbox"/>	<input type="checkbox"/>	<input type="checkbox"/>	<input type="checkbox"/>	<input type="checkbox"/>	<input type="checkbox"/>
13	_____	_____	<input type="checkbox"/>	<input type="checkbox"/>	<input type="checkbox"/>	<input type="checkbox"/>	<input type="checkbox"/>	<input type="checkbox"/>	<input type="checkbox"/>	<input type="checkbox"/>	<input type="checkbox"/>	<input type="checkbox"/>	<input type="checkbox"/>	<input type="checkbox"/>
12	_____	_____	<input type="checkbox"/>	<input type="checkbox"/>	<input type="checkbox"/>	<input type="checkbox"/>	<input type="checkbox"/>	<input type="checkbox"/>	<input type="checkbox"/>	<input type="checkbox"/>	<input type="checkbox"/>	<input type="checkbox"/>	<input type="checkbox"/>	<input type="checkbox"/>
11	_____	_____	<input type="checkbox"/>	<input type="checkbox"/>	<input type="checkbox"/>	<input type="checkbox"/>	<input type="checkbox"/>	<input type="checkbox"/>	<input type="checkbox"/>	<input type="checkbox"/>	<input type="checkbox"/>	<input type="checkbox"/>	<input type="checkbox"/>	<input type="checkbox"/>
10	_____	_____	<input type="checkbox"/>	<input type="checkbox"/>	<input type="checkbox"/>	<input type="checkbox"/>	<input type="checkbox"/>	<input type="checkbox"/>	<input type="checkbox"/>	<input type="checkbox"/>	<input type="checkbox"/>	<input type="checkbox"/>	<input type="checkbox"/>	<input type="checkbox"/>
9	_____	_____	<input type="checkbox"/>	<input type="checkbox"/>	<input type="checkbox"/>	<input type="checkbox"/>	<input type="checkbox"/>	<input type="checkbox"/>	<input type="checkbox"/>	<input type="checkbox"/>	<input type="checkbox"/>	<input type="checkbox"/>	<input type="checkbox"/>	<input type="checkbox"/>
8	_____	_____	<input type="checkbox"/>	<input type="checkbox"/>	<input type="checkbox"/>	<input type="checkbox"/>	<input type="checkbox"/>	<input type="checkbox"/>	<input type="checkbox"/>	<input type="checkbox"/>	<input type="checkbox"/>	<input type="checkbox"/>	<input type="checkbox"/>	<input type="checkbox"/>
7	_____	_____	<input type="checkbox"/>	<input type="checkbox"/>	<input type="checkbox"/>	<input type="checkbox"/>	<input type="checkbox"/>	<input type="checkbox"/>	<input type="checkbox"/>	<input type="checkbox"/>	<input type="checkbox"/>	<input type="checkbox"/>	<input type="checkbox"/>	<input type="checkbox"/>
6	_____	_____	<input type="checkbox"/>	<input type="checkbox"/>	<input type="checkbox"/>	<input type="checkbox"/>	<input type="checkbox"/>	<input type="checkbox"/>	<input type="checkbox"/>	<input type="checkbox"/>	<input type="checkbox"/>	<input type="checkbox"/>	<input type="checkbox"/>	<input type="checkbox"/>
5	_____	_____	<input type="checkbox"/>	<input type="checkbox"/>	<input type="checkbox"/>	<input type="checkbox"/>	<input type="checkbox"/>	<input type="checkbox"/>	<input type="checkbox"/>	<input type="checkbox"/>	<input type="checkbox"/>	<input type="checkbox"/>	<input type="checkbox"/>	<input type="checkbox"/>
4	_____	_____	<input type="checkbox"/>	<input type="checkbox"/>	<input type="checkbox"/>	<input type="checkbox"/>	<input type="checkbox"/>	<input type="checkbox"/>	<input type="checkbox"/>	<input type="checkbox"/>	<input type="checkbox"/>	<input type="checkbox"/>	<input type="checkbox"/>	<input type="checkbox"/>
3	_____	_____	<input type="checkbox"/>	<input type="checkbox"/>	<input type="checkbox"/>	<input type="checkbox"/>	<input type="checkbox"/>	<input type="checkbox"/>	<input type="checkbox"/>	<input type="checkbox"/>	<input type="checkbox"/>	<input type="checkbox"/>	<input type="checkbox"/>	<input type="checkbox"/>
2	_____	_____	<input type="checkbox"/>	<input type="checkbox"/>	<input type="checkbox"/>	<input type="checkbox"/>	<input type="checkbox"/>	<input type="checkbox"/>	<input type="checkbox"/>	<input type="checkbox"/>	<input type="checkbox"/>	<input type="checkbox"/>	<input type="checkbox"/>	<input type="checkbox"/>
1	_____	_____	<input type="checkbox"/>	<input type="checkbox"/>	<input type="checkbox"/>	<input type="checkbox"/>	<input type="checkbox"/>	<input type="checkbox"/>	<input type="checkbox"/>	<input type="checkbox"/>	<input type="checkbox"/>	<input type="checkbox"/>	<input type="checkbox"/>	<input type="checkbox"/>

Please indicate required COP(s) locations and which is Main COP (with service cabinet) should be left blank.

M = Main
 A = Auxiliary

Front	Front	Front	Front	Front	Front
<input type="checkbox"/>	<input type="checkbox"/>	<input type="checkbox"/>	<input type="checkbox"/>	<input type="checkbox"/>	<input type="checkbox"/>
<input type="checkbox"/>	<input type="checkbox"/>	<input type="checkbox"/>	<input type="checkbox"/>	<input type="checkbox"/>	<input type="checkbox"/>
Rear	Rear	Rear	Rear	Rear	Rear

Once you've completed your survey, please fax it to 954-917-7337 or email it to info@seesinc.com



SEES ELEVATOR FIXTURES

RFQ SURVEY SHEET - COP

PROJECT _____
CAR # (s) _____

COP SIZE	
COP Width	_____
COP Height	_____
Top Of Car Station From Floor	_____

COP TYPE	
<input type="checkbox"/> Applied COP with Hinged Box	<input type="checkbox"/> Swing Type COP

COP FINISH	
<input type="checkbox"/> Brushed (#4) Stainless Steel	

INSTRUCTIONS

1) Make sure to check the box if the components are to be placed in Main and/or in Aux COP

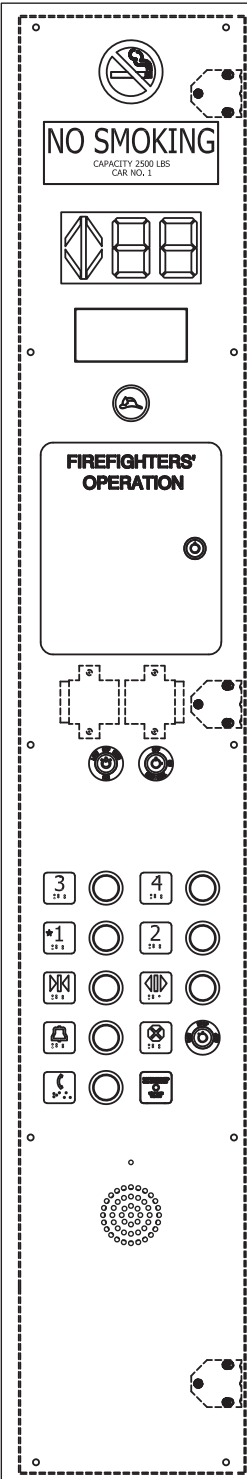

HINGE		<input type="checkbox"/> LH	<input type="checkbox"/> RH
-------	--	-----------------------------	-----------------------------

CAR PANEL MARKINGS		<input type="checkbox"/> Main	<input type="checkbox"/> Aux
<input type="checkbox"/> Capacity lbs	<input type="checkbox"/> Car#	<input type="checkbox"/> Installation #	
<input type="checkbox"/> Certificate Window	<input type="checkbox"/> Window Size		
<input type="checkbox"/> No Smoking Verbage	<input type="checkbox"/> No Smoking Symbol	<input type="checkbox"/> Other: _____	

POSITION INDICATOR		<input type="checkbox"/> Main	<input type="checkbox"/> Aux
Type	<input type="checkbox"/> 2" 16 Seg. <input type="checkbox"/> 1" 16 Seg. <input type="checkbox"/> .5" 16 Seg.	<input type="checkbox"/> Single	<input type="checkbox"/> Double <input type="checkbox"/> Passing Chime
Signal Format	<input type="checkbox"/> Micro Comm <input type="checkbox"/> Binary <input type="checkbox"/> Line/Floor <input type="checkbox"/> M4 Serial		
Display Color	<input type="checkbox"/> Red <input type="checkbox"/> Green <input type="checkbox"/> Amber <input type="checkbox"/> Blue <input type="checkbox"/> White		

EMERGENCY LIGHT		<input type="checkbox"/> Main	<input type="checkbox"/> Aux
Emergency Light	Emergency Light charger board, Battery Pack	Voltage	<input type="checkbox"/> 6V <input type="checkbox"/> 12V
Lens	<input type="checkbox"/> Projecting <input type="checkbox"/> Flat		

FIRE OPERATION		<input type="checkbox"/> Main	<input type="checkbox"/> Aux
Code Year	<input type="checkbox"/> ANSI-96 <input type="checkbox"/> ANSI-2000 <input type="checkbox"/> ANSI-2004 <input type="checkbox"/> ANSI-2007 <input type="checkbox"/> New York		
Key Code	<input type="checkbox"/> Yale 255 <input type="checkbox"/> Yale 3502 <input type="checkbox"/> Yale 2642 <input type="checkbox"/> FEO-K1 <input type="checkbox"/> MFD-1 <input type="checkbox"/> AZFS		
Others	<input type="checkbox"/> WD01 <input type="checkbox"/> SC1000 <input type="checkbox"/> Medeco <input type="checkbox"/> BFD-1 <input type="checkbox"/> AS100		
<input type="checkbox"/> Fireman Phone Jack			

SPECIAL FUNCTION		<input type="checkbox"/> Main	<input type="checkbox"/> Aux
<input type="checkbox"/> Hospital Service (Indicator + Key Switch)	<input type="checkbox"/> Code Blue (Indicator + Key Switch)		
<input type="checkbox"/> Emergency Power (Indicator)	<input type="checkbox"/> Seismic/ Earthquake (Indicator)		
<input type="checkbox"/> Overload (Indicator)	<input type="checkbox"/> Fire Buzzer		
<input type="checkbox"/> Attendant Service (Arrows + Push Buttons)	<input type="checkbox"/> Nudging Buzzer		
<input type="checkbox"/> Other _____	<input type="checkbox"/> Voice Annunciation		

KEY SWITCHES		<input type="checkbox"/> Main	<input type="checkbox"/> Aux
<input type="checkbox"/> Service Cabinet	<input type="checkbox"/> Independent Service	<input type="checkbox"/> 1 Spd Fan	<input type="checkbox"/> 2 Spd Fan <input type="checkbox"/> 3 Spd Fan
<input type="checkbox"/> Surface Mount	<input type="checkbox"/> Emergency Light Test Switch	<input type="checkbox"/> Inspection On/Off	
	<input type="checkbox"/> Inspection Up/Down	<input type="checkbox"/> Light/Fan(1 spd)	<input type="checkbox"/> Light/Fan(2 spd)
	<input type="checkbox"/> Light <input type="checkbox"/> Light Dimmer	<input type="checkbox"/> Access/Enable	<input type="checkbox"/> Toggle Switch Option
	<input type="checkbox"/> GFCI <input type="checkbox"/> Other _____		

PUSHBUTTONS (See Appendix A)	
Button Series	<input type="checkbox"/> PB-10 <input type="checkbox"/> PB-13 <input type="checkbox"/> PBR <input type="checkbox"/> PB-22J
	<input type="checkbox"/> PB-30 <input type="checkbox"/> PB-129 <input type="checkbox"/> PB-510S
Illumination	<input type="checkbox"/> Blue <input type="checkbox"/> White <input type="checkbox"/> Red
Voltage	<input type="checkbox"/> 24VDC <input type="checkbox"/> PB-30M Multi-Volt (24V to 120VDC/AC, 6VDC)

BRAILLE STYLE	
	<input type="checkbox"/> Round <input type="checkbox"/> Crescent <input type="checkbox"/> Square
Color	<input type="checkbox"/> White / Black <input type="checkbox"/> Silver / Black

UTILITY PUSHBUTTONS		<input type="checkbox"/> Main	<input type="checkbox"/> Aux
<input type="checkbox"/> Alarm	<input type="checkbox"/> Phone	<input type="checkbox"/> Door Open & Close	<input type="checkbox"/> Rear DO/DC <input type="checkbox"/> Door Hold
<input type="checkbox"/> Stop (Push Pull Type)	<input type="checkbox"/> Stop (Key Switch Type)	<input type="checkbox"/> Call Cancel	<input type="checkbox"/> Rear Door Hold

PHONE AND VOICE		<input type="checkbox"/> Main	<input type="checkbox"/> Aux
		<input type="checkbox"/> Rath	<input type="checkbox"/> Kings III <input type="checkbox"/> KTECH PHONE <input type="checkbox"/> Wurtec

Once you've completed your survey, please fax it to 954-917-7337 or email it to info@seesinc.com



ELEVATOR FIXTURES

RFQ SURVEY SHEET - HALL STATION

PROJECT _____
CAR # (s) _____
 Style : (See Appendix for full layouts)

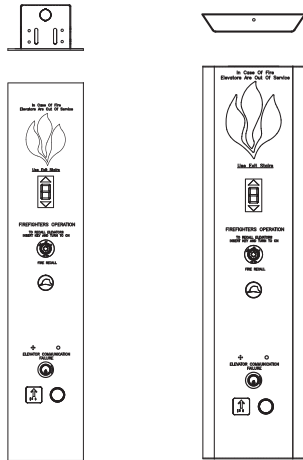

Flush Mount Surface Mount

Hall Station Riser Chart

Please fill in quantity of each type required at each landing

Landing	HS1	HS2	HS3	HS4
23				
22				
21				
20				
19				
18				
17				
16				
15				
14				
13				
12				
11				
10				
9				
8				
7				
6				
5				
4				
3				
2				
1				

Notes:

TYPICAL FINISH UNLESS SPECIFIED

Hall STATION Finish	<input type="checkbox"/> Brushed (#4) Stainless Steel	<input type="checkbox"/> Brushed 150 Grit Stainless Steel
---------------------	---	---

HALL STATION DETAILS

HALL STATION #1 (HS1)		<input type="checkbox"/> Terminal	<input type="checkbox"/> Intermediate
Type	<input type="checkbox"/> Flush	<input type="checkbox"/> Surface Mount	
SIZE			
HS Size	H: W:	Hole Center:	C-C:
PUSHBUTTONS (See Appendix)			
Button Series	<input type="checkbox"/> Match with COP	<input type="checkbox"/> Other	
LED illumination	<input type="checkbox"/> Match with COP	<input type="checkbox"/> Other	
MISCELLANEOUS FEATURES			
Indicators	<input type="checkbox"/> Position Indicator	<input type="checkbox"/> 1" <input type="checkbox"/> 0.5"	<input type="checkbox"/> Single <input type="checkbox"/> Double Character
	<input type="checkbox"/> Red <input type="checkbox"/> Green <input type="checkbox"/> Amber	<input type="checkbox"/> Blue <input type="checkbox"/> White	
PLV	<input type="checkbox"/> Phone Line Verification	PCB Location	<input type="checkbox"/> HOP <input type="checkbox"/> COP
Braille	<input type="checkbox"/> Match COP	<input type="checkbox"/> Fire Service	Access <input type="checkbox"/>

HALL STATION #2 (HS2)		<input type="checkbox"/> Terminal	<input type="checkbox"/> Intermediate
Type	<input type="checkbox"/> Flush	<input type="checkbox"/> Surface Mount	
SIZE			
HS Size	H: W:	Hole Center:	C-C:
PUSHBUTTONS (See Appendix)			
Button Series	<input type="checkbox"/> Match with COP	<input type="checkbox"/> Other	
LED illumination	<input type="checkbox"/> Match with COP	<input type="checkbox"/> Other	
MISCELLANEOUS FEATURES			
Indicators	<input type="checkbox"/> Position Indicator	<input type="checkbox"/> 1" <input type="checkbox"/> 0.5"	<input type="checkbox"/> Single <input type="checkbox"/> Double Character
	<input type="checkbox"/> Red <input type="checkbox"/> Green <input type="checkbox"/> Amber	<input type="checkbox"/> Blue <input type="checkbox"/> White	
PLV	<input type="checkbox"/> Phone Line Verification	PCB Location	<input type="checkbox"/> HOP <input type="checkbox"/> COP
Braille	<input type="checkbox"/> Match COP	<input type="checkbox"/> Fire Service	Access <input type="checkbox"/>

HALL STATION #3 (HS3)		<input type="checkbox"/> Terminal	<input type="checkbox"/> Intermediate
Type	<input type="checkbox"/> Flush	<input type="checkbox"/> Surface Mount	
SIZE			
HS Size	H: W:	Hole Center:	C-C:
PUSHBUTTONS (See Appendix)			
Button Series	<input type="checkbox"/> Match with COP	<input type="checkbox"/> Other	
LED illumination	<input type="checkbox"/> Match with COP	<input type="checkbox"/> Other	
MISCELLANEOUS FEATURES			
Indicators	<input type="checkbox"/> Position Indicator	<input type="checkbox"/> 1" <input type="checkbox"/> 0.5"	<input type="checkbox"/> Single <input type="checkbox"/> Double Character
	<input type="checkbox"/> Red <input type="checkbox"/> Green <input type="checkbox"/> Amber	<input type="checkbox"/> Blue <input type="checkbox"/> White	
PLV	<input type="checkbox"/> Phone Line Verification	PCB Location	<input type="checkbox"/> HOP <input type="checkbox"/> COP
Braille	<input type="checkbox"/> Match COP	<input type="checkbox"/> Fire Service	Access <input type="checkbox"/>

HALL STATION #4 (HS4)		<input type="checkbox"/> Terminal	<input type="checkbox"/> Intermediate
Type	<input type="checkbox"/> Flush	<input type="checkbox"/> Surface Mount	
SIZE			
HS Size	H: W:	Hole Center:	C-C:
PUSHBUTTONS (See Appendix)			
Button Series	<input type="checkbox"/> Match with COP	<input type="checkbox"/> Other	
LED illumination	<input type="checkbox"/> Match with COP	<input type="checkbox"/> Other	
MISCELLANEOUS FEATURES			
Indicators	<input type="checkbox"/> Position Indicator	<input type="checkbox"/> 1" <input type="checkbox"/> 0.5"	<input type="checkbox"/> Single <input type="checkbox"/> Double Character
	<input type="checkbox"/> Red <input type="checkbox"/> Green <input type="checkbox"/> Amber	<input type="checkbox"/> Blue <input type="checkbox"/> White	
PLV	<input type="checkbox"/> Phone Line Verification	PCB Location	<input type="checkbox"/> HOP <input type="checkbox"/> COP
Braille	<input type="checkbox"/> Match COP	<input type="checkbox"/> Fire Service	Access <input type="checkbox"/>



ELEVATOR FIXTURES

RFQ SURVEY SHEET - CAR DIRECTION ARROWS

PROJECT _____

CAR # (s) _____

Style : (See Appendix for full layouts)

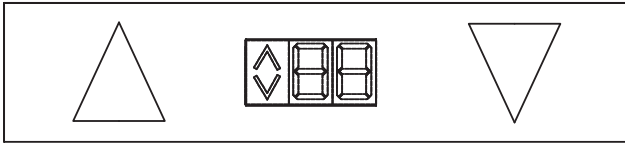

Flat Plate

Hall Lantern Riser Chart

Please fill in quantity of each type required at each landing

Landing	L1	L2	L3	L4
23				
22				
21				
20				
19				
18				
17				
16				
15				
14				
13				
12				
11				
10				
9				
8				
7				
6				
5				
4				
3				
2				
1				

Notes:

TYPICAL FINISH UNLESS SPECIFIED

Hall LANTERN Finish	<input type="checkbox"/> Brushed (#4) Stainless Steel	<input type="checkbox"/> Brushed 150 Grit Stainless Steel
---------------------	---	---

HALL LANTERN DETAILS

HALL LANTERN #1 (L1)		<input type="checkbox"/> Vertical	<input type="checkbox"/> Horizontal
		<input type="checkbox"/> Terminal	<input type="checkbox"/> Intermediate
TYPE	<input type="checkbox"/> Flush <input type="checkbox"/> Surface		
Arrow Type	<input type="checkbox"/> Traditional Arrow <input type="checkbox"/> Round <input type="checkbox"/> Vandal		
SIZE			
HL Size	Length:	Width:	Hole Centers:
OTHER			
Position Indicator	<input type="checkbox"/> 2" <input type="checkbox"/> 1" <input type="checkbox"/> Single <input type="checkbox"/> Double <input type="checkbox"/> Red <input type="checkbox"/> Blue <input type="checkbox"/> White <input type="checkbox"/> Amber		
	<input type="checkbox"/> Lantern Only <input type="checkbox"/> PI/Lantern Combo		
Chime	<input type="checkbox"/> Chime		
Illumination	Up Arrow		Down Arrow
	<input type="checkbox"/> Red <input type="checkbox"/> Green <input type="checkbox"/> White	<input type="checkbox"/> Red <input type="checkbox"/> Green <input type="checkbox"/> White	<input type="checkbox"/> LED <input type="checkbox"/> Incandescent

HALL LANTERN #2 (L2)		<input type="checkbox"/> Vertical	<input type="checkbox"/> Horizontal
		<input type="checkbox"/> Terminal	<input type="checkbox"/> Intermediate
TYPE	<input type="checkbox"/> Flush <input type="checkbox"/> Surface		
Arrow Type	<input type="checkbox"/> Traditional Arrow <input type="checkbox"/> Round <input type="checkbox"/> Vandal		
SIZE			
HL Size	Length:	Width:	Hole Centers:
OTHER			
Position Indicator	<input type="checkbox"/> 2" <input type="checkbox"/> 1" <input type="checkbox"/> Single <input type="checkbox"/> Double <input type="checkbox"/> Red <input type="checkbox"/> Blue <input type="checkbox"/> White <input type="checkbox"/> Amber		
	<input type="checkbox"/> Lantern Only <input type="checkbox"/> PI/Lantern Combo		
Chime	<input type="checkbox"/> Chime		
Illumination	Up Arrow		Down Arrow
	<input type="checkbox"/> Red <input type="checkbox"/> Green <input type="checkbox"/> White	<input type="checkbox"/> Red <input type="checkbox"/> Green <input type="checkbox"/> White	<input type="checkbox"/> LED <input type="checkbox"/> Incandescent

HALL LANTERN #3 (L3)		<input type="checkbox"/> Vertical	<input type="checkbox"/> Horizontal
		<input type="checkbox"/> Terminal	<input type="checkbox"/> Intermediate
TYPE	<input type="checkbox"/> Flush <input type="checkbox"/> Surface		
Arrow Type	<input type="checkbox"/> Traditional Arrow <input type="checkbox"/> Round <input type="checkbox"/> Vandal		
SIZE			
HL Size	Length:	Width:	Hole Centers:
OTHER			
Position Indicator	<input type="checkbox"/> 2" <input type="checkbox"/> 1" <input type="checkbox"/> Single <input type="checkbox"/> Double <input type="checkbox"/> Red <input type="checkbox"/> Blue <input type="checkbox"/> White <input type="checkbox"/> Amber		
	<input type="checkbox"/> Lantern Only <input type="checkbox"/> PI/Lantern Combo		
Chime	<input type="checkbox"/> Chime		
Illumination	Up Arrow		Down Arrow
	<input type="checkbox"/> Red <input type="checkbox"/> Green <input type="checkbox"/> White	<input type="checkbox"/> Red <input type="checkbox"/> Green <input type="checkbox"/> White	<input type="checkbox"/> LED <input type="checkbox"/> Incandescent

HALL LANTERN #4 (L4)		<input type="checkbox"/> Vertical	<input type="checkbox"/> Horizontal
		<input type="checkbox"/> Terminal	<input type="checkbox"/> Intermediate
TYPE	<input type="checkbox"/> Flush <input type="checkbox"/> Surface		
Arrow Type	<input type="checkbox"/> Traditional Arrow <input type="checkbox"/> Round <input type="checkbox"/> Vandal		
SIZE			
HL Size	Length:	Width:	Hole Centers:
OTHER			
Position Indicator	<input type="checkbox"/> 2" <input type="checkbox"/> 1" <input type="checkbox"/> Single <input type="checkbox"/> Double <input type="checkbox"/> Red <input type="checkbox"/> Blue <input type="checkbox"/> White <input type="checkbox"/> Amber		
	<input type="checkbox"/> Lantern Only <input type="checkbox"/> PI/Lantern Combo		
Chime	<input type="checkbox"/> Chime		
Illumination	Up Arrow		Down Arrow
	<input type="checkbox"/> Red <input type="checkbox"/> Green <input type="checkbox"/> White	<input type="checkbox"/> Red <input type="checkbox"/> Green <input type="checkbox"/> White	<input type="checkbox"/> LED <input type="checkbox"/> Incandescent

NEW
CUTTING-EDGE



LifeLine



SEES CELLULAR ELEVATOR PHONE

✓ LifeLine Features

- 10 hrs of backup battery
- 6 easy to read LED status lights
- Remotely Monitored
- Works with all elevator phones
- Directly replaces a POTS line
- Allows incoming & outgoing emergency calls
- Commercial strength, UL listed enclosure

✓ LifeLine Specs

- Output: 10 to 17 VDC (24)
- Input: 230 VAC
- Connector: RJ-11
- Battery: 8h in stand by; 2h in conversation
- Backup battery: NiMH 800 mAh
- RJ-11 Jack Connection

“SEES LifeLine Works With Any Phone.”

The new commercial strength SEES LifeLine replaces the need of expensive phone lines and delivers a dedicated, code compliant, communication path for any analog elevator phone to a pre-programmed call center.



1.800.526.0026

www.SEEInc.com

f facebook.com/SEESinc

t twitter.com/SEESinc

2781 W. McNab Rd. Pompano Beach, FL 33069

Emergency Telephones



PH-BM-001



PH-FM-002,
PH-MFM-002



PH-LPSM-003



PH-MLPSM-003

K-Tech

S.E.E.S. #	Description
PH-BM-001	Emergency Phone , Sentry, Box Mount, 7.75" H x 5" W x 2" D, line powered
PH-MBM-001	Emergency Phone , Sentry, Box Mount, 7.75" H x 5" W x 2" D, multi line
PH-ECFP-001	Phone , Fire Panel, Elevator Communication Failure with key and LED Indic. 120 VAC
PH-FM-002	Emergency Phone , Single Line, Fortress Flush Mount, 12.5" H x 10" W x 1.2" Depth, line-powered
PH-FM-002S	Emergency Phone , Single Line, Fortress Flush Mount, Small Face Plate, line-powered
PH-FM-002SM	Emergency Phone , Fortress Flush Mount #4 Muntz, 10.5" x 6.5", ET1401A
PH-LLP-001	Emergency Phone , Line Loss Processor, 120 VAC
PH-LPL-001	Emergency Phone , Liberator, Phone/Light Combo, Low Profile, Surface Mount, 9.5" H x 6.75" W x 1" Depth
PH-LPSM-003	Emergency Phone , Single Line, Liberator Low Profile Surface Mount, 6.75" H x 6.25" W x 1" Depth, line-powered
PH-MFM-002	Emergency Phone , Multit-Line, Fortress Flush Mount, 120 VAC
PH-MFM-002S	Emergency Phone , Multit-Line, Fortress Flush Mount Small Face Plate, 120 VAC
PH-MLPSM-003	Emergency Phone , Multit-Line, Liberator Low Profile Surface Mount, 120 VAC
PH-MTP-001	Emergency Phone , Multit-Line, Mechanic Test Phone, 120 VAC
PH-MUFM-004	Emergency Phone , Multit-Line, Universal Commander Fixture Mount, 120 VAC
PH-INT-001	Emergency Phone , Machine Room Lobby to Elevators Communications, 120 VAC
PH-RFM-002	Emergency Phone , Flush Mount Keypad Speakerphone, 120 VAC
PH-RFM-002M	Emergency Phone , Muntz, Flush Mount Keypad Speakerphone
PH-RMLM-001	Emergency Phone , Remote Monitoring Line Mngr/Sharing Device, 120 VAC
PH-TLSP-001	Emergency Phone , Telephone Line Surge Protector, 120 VAC
PH-UFM-004	Emergency Phone , Universal Commander Fixture Mount, Line Powered
PH-UFM-005	Emergency Phone , Universal Panel Mount, Auto Dialer, Line Powered
PH-UFM-006	Emergency Phone , Standard Mount, Line Powered, 9.5" x 4.75"
PH-V1600A	Emergency Phone , 1600A Series, ADA Compliant
PH-WSSM-001	Emergency Phone , Weather Sealed Surface Mount, Phone Line Powered



PH-MTP-001



PH-INT-001



PH-RFM-002

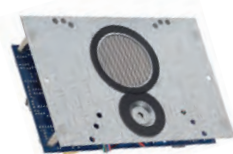

PH-UFM-004
PH-MUFM-004



PH-UFM-005



PH-UFM-006

Telephone Boxes

Solid stainless steel cover with painted interior provides durable, and secure emergency phone storage. Hinged door allows full phone access, and the unique piston design ensures a tight close.

S.E.E.S. #	Description
SEES-LLM-001	Phone, Line Loss Module
SEES-LLM-002	Phone, Line Loss Lobby Display
SEES-LLM-003	Phone, Line Loss Display Board
MIS-T-100	Telephone Box, Stainless Steel cover is 10" W x 12.5" H, box size is 9" W x 10.62" H
MIS-TH-100	Aluminum handle, Replacement handle, marked "PHONE", drill holes c/c 1"
MIS-TH-100-P	Plastic Handle, Replacement handle for telephone box, black plastic with white marking "PHONE", drill holes c/c 1"



SEES-LLM-001



SEES-LLM-003

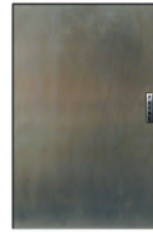

MIS-T-100



MIS-TH-100

Kings III



PH-KMST-4



PH-KFM-3000-0609



PH-KSM-3000

S.E.E.S. #	O.E.M. #	Description
PH-KMSK-1	MSK-1	Master Station Set, Phone and CN-8 Router
PH-KMST-4	MST-4	Master Station Phone, Four line phone for machine room, security desk, or fire control
PH-KROUGH-IN-BOX	Rough-in Box	Rough-in Box, (for Lobby phone)
PH-KWL-3000C	WL-3000C	Wheelchair Lift Phone, (Cellular) Complete phone powder coated tan., Requires cellular service from Kings III & 120 VAC power
PH-KWL-3000	WL-3000	Wheelchair Lift Phone, Complete phone with powder coated tan housing. Designed for surface mount in wheelchair lifts
PH-KFM-3000-DP	FM-3000-DP	Phone, Dover Flush Mount Complete phone including cover for direct bolt-on upgrade for Thyssen/Dover black phone cabinet door
PH-KFM-3000-1114	FM-3000 114	Phone, Flush Mount Complete phone including flush cover 11" x 14", for installation replacing phone box doors
PH-KFM-3000-1012	FM-3000 1012	Phone, Flush Mount Complete phone including flush cover 10" x 12", for installation replacing phone box doors
PH-KFM-3000-0609	FM-3000 69	Phone, Flush Mount Complete phone including flush cover 6" x 9", for installation replacing phone box doors
PH-KSM-3000	SM-3000	Phone, Surface Mount Complete phone including cover for installation in phone box below car station. Shell Dimensions 7-1/4" H x 4-1/4" W x 2-1/8" D
PH-KSC-3000-U	SC-3000-U	COP Phone, Universal Mounting, Board, Speaker, MIC No Button, universal mounting plate, behind car station (no button), 4-3/4" W x 9-1/2" H x 2" D
PH-KSC-3000-NB	SC-3000-NB	COP Phone, Small mounting, Board, Speaker, MIC, No Button small mounting plate for installation behind car station (no button), 3/34" W x 7" H x 2" D
PH-KSC-3000	SC-3000	COP Phone, Small mounting, Board, Speaker, MIC & Button, small mounting plate for installation behind car station, 3-3/4" W x 7" H x 2" D
PH-KIP-3000-01	IP-3000 -1	Phone, Lobby/Intercom Phone for 1 Car, 6" x 9" stainless steel faceplate with selector switch for comm with elev phone
PH-KIP-3000-02	IP-3000 -2	Phone, Lobby/Intercom Phone for 2 Car, 6" x 9" stainless steel faceplate with selector switch for comm with elev phone
PH-KIP-3000-03	IP-3000 -3	Phone, Lobby/Intercom Phone for 3 Car, 6" x 9" stainless steel faceplate with selector switch for comm with elev phone
PH-WS3C-11-933	11-933	Phone, S3C, Building Power, Grill Mount without Push Button
PH-WS3C-ALARM	11-930-CA	Phone, S3C, Alarm Board for Communication Failure

Rath

S.E.E.S. #	O.E.M. #	Description
PH-R2100-957CC	2100-957CC	Phone, COP 12-24 VDC
PH-R2100-GSM	2100-GSM	Phone, 2100 GSM Unit
PH-R2400-807CC	2400-807CC	Phone, Line Powered 2400-807CC
PH-R2400-807RAS	2400-807RAS	Phone, Line Powered Compact COP
PH-R2100-907RA	2100-907RAS	Phone, COP 120 VAC or 24AC/DC Power Required 5-3/8" H x 4-1/2" W x 2" D
PH-R2100-957RA	2100-957RAS	Phone, COP 120 VAC or 24AC/DC Power Required 8-1/8" H x 5-1/8" W x 2" D
PH-R2100-957RASH	2100-957RAS	Phone, COP 120 VAC or 24AC/DC Power Required 8-1/8" H x 5-1/8" W x 2" D
PH-R2500-205PSS	R2500-205PSS	SmartRescue, Base Station
PH-RSM-2100-SVC	2100-SVC	SmartView, Behind Panel Controller
PH-RSM-2100-SVCB	2100-SVCB	SmartView, Controller Mounted in Ceiling Box
PH-RSM-2100-SVCD	2100-SVCD	SmartView, Ceiling Mount Dome Camera
PH-RSM-2100-SVCF	2100-SVCF	SmartView, Panel Mount Camera with Mtg Brkt & Bubble Window
PH-RSM-2100-SVD	2100-SVD	SmartView, Panel Mount Display with 0.0625" Acrylic Window
PH-RSM-2100-SVDA	2100-SVDA	SmartView, Panel Mount Display with 0.125" Acrylic Window
PH-RSM-2100-SVDB	2100-SVDB	SmartView, Panel Mount Display with 0.109" Acrylic Window
PH-RSM-2100-SVDC	2100-SVDC	SmartView, Panel Mount Display with 0.078" Acrylic Window
PH-RSM-2100-SVDE	2100-SVDE	SmartView, Panel Mount Display with 0.118" Acrylic Window
PH-RSM-2100-SVE	2100-SVE	SmartView, 2-Wire Ethernet Extender, Includes PoE
PH-RSM-2100-SVFCOMP	2100-SVFCOMP	SmartView, SS Flush Kit, Field Mount Controller, Pinhole Camera, Display and Y/N Buttons
PH-RSM-2100-SVSCOMP	2100-SVSCOMP	SmartView, SS Surface Kit, Field Mount, Pinhole Camera, Display and Y/N Buttons
PH-RSM-RP7300102	RP7300102	SmartView, SS Buttons for Yes/No
PH-RSM-RP7700104S	RP7700104S	SmartView, UPS Power Supply
PH-RATH-BAT-001	RP7300110	Battery, for Rath SmartPhone Models III-VI
PH-R-RP7900601	RP7900601	Junction Board, Rath
PH-R-SUBRP7900600	SUBRP7900600	Alarm Board, Rath



PH-R2100-957CC



PH-RATH-BAT-001

Miscellaneous Phones

S.E.E.S. #	O.E.M. #	Description
PH-JPNB	PNB PHONE	Phone, PNB Janus
PH-WS3C-11-913	11-913	Phone, S3C, Line Power, Grill Mount without Push Button
PH-WS3C-ALARM	11-930-CA	Phone, S3C, Alarm Board for Communication Failure
PH-WSSM-001	ER401A-WS	Emergency Phone, Weather sld



PH-JPNB



PH-WS3C-11-913



PH-WSSM-001



SEES LINE ALERT®

The SEES LINE ALERT is designed to detect faults and disruptions in telephone service. It provides visual and audible local alerts when a problem is detected by flashing red and sounding an alarm. Audible alerts can be silenced.

S.E.E.S. #	Description
SEES-PLV-001	SEES LINE ALERT, Phone Line Verification, Flush mount, 12-24 VDC
SEES-PLV-001A	SEES LINE ALERT, Flush Mount 12 VDC, Compact Design 5-3/4" x 7"
SEES-PLV-001D	SEES LINE ALERT, Flush Mount, Duplex Panel
SEES-PLV-002	SEES LINE ALERT, Phone Line Verification, Surface mount, 12-24 VDC
SEES-PLV-003	SEES LINE ALERT, Surface Mount 12 VDC, with Test Feature
SEES-PLV-PCB	SEES LINE ALERT, PLV PCB Only
SEES-PLV-LED	SEES LINE ALERT, Replacement LED only
SEES-PLV-BUZZER	SEES LINE ALERT, Replacement Buzzer only

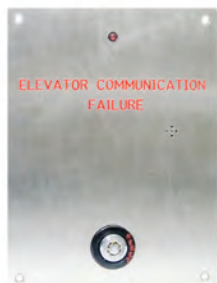

SEES-PLV-001



SEES-PLV-003



SEES-PLV-LED



SEES-PLV-BUZZER



SEES-PH-002



SEES-PH-003



SEES-PH-003A



SEES-PH-004



SEES-PH-005



SEES-PH-006

SEES Phones

S.E.E.S. #	Description
SEES-FVCS-SM-001	SEES Fixture Visual Communications System, Surface Mount, Rath Smartview
SEES-PH-001	Phone Autodialer, 12V for COP Mounting
SEES-PH-002	Phone Autodialer, 24V for COP Mounting
SEES-PH-003	LifeLine GSM Module, 500GC Voice only, with Battery Backup Cable, Antenna, Magnetic Base, cellular
SEES-PH-003A	Wireless GSM Module 4G LTE, with Battery Backup Cable, Antenna, Magnetic Base
SEES-PH-003B	Wireless Module CDMA(800/1900Mhz) with Battery Backup, Cable, Antenna, Magnetic Base
SEES-PH-004	LifeLine GSM Module, 500NET Voice & Data, with Battery Backup Cable, Antenna, Magnetic Base, cellular
SEES-PH-005	Handsfree Communication Unit, Speaker and Microphone
SEES-PH-006	Analog Telephone, for Machine Room



The **SEES LINE ALERT®** is designed to detect faults and disruptions in telephone service. It provides visual and audible local alerts when a problem is detected by flashing red and sounding an alarm. Audible alerts can be silenced.



Part Number: SEES-PLV-001
SEES LINE ALERT Phone Line Verification

The technology you need to comply with emerging codes. Telephone line status verification is a requirement of ASME A17.1b-2009 for new or altered elevators. (Section 2.27.1.1.6)

The SEES-PLV-001 SEES LINE ALERT is designed to detect faults and disruptions in telephone service and provide visual and audible local alerts when a problem is detected. Audible alerts can be silenced. Visual alert automatically resets when phone line is restored.

Compatible with ALL emergency phones.

*Available in flush mount (SEES-PLV-001) and surface mount (SEES-PLV-002).

Always Smooth Sailing



@SEESinc



SEESinc.com/blogs



SEESinc

PROMO:
VANDAL



PUSH BUTTONS THAT PUSH BACK!



SEES-PB-30-B

blue
LED

Brushed stainless steel, flat, vandal resistant, with blue LED

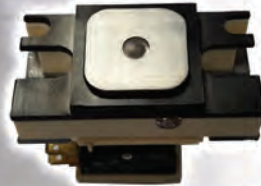

DB-77A-VAN-B

NEW

Push button, vandal proof with 2 micro switches, aluminum or black finish Available with original target lens



TPB-002

24V
VP

Push button, 24V, vandal resistant, 9835641



red
LED

OPB-150

Push button, 6VDC SS Red LED AAA23500BZ18



TPB-200

Button, Blank, Stainless, vandal proof, 9739490



1 NO
24V

SB-6-VAN

Push button, vandal proof, 24V, 1NO Sw



DB-100

push
ME!

Button, vandal proof, 9738990



DUPB-009

SEES
VP

Push button, 24V Dupar N.O. Rn US93



Aluminum Vandal Ring for US Soft Touch Series

US-B50-CAR-HALL-RING



TPB-RING

Aluminum Vandal Ring for TPB Series



@SEESinc



SEESinc.com/blogs



SEESinc

Always Smooth Sailing



SOUTHERN ELEVATOR
& ELECTRIC SUPPLY

2781 WEST McNAB ROAD, POMPANO BEACH, FL 33069 • 800-526-0026 • www.SEESinc.com

APPENDIX A

PB-10 Series PushButton

	Finish	Description
	Stainless Steel Brushed	Pushbutton, stainless steel, brushed, flat with blue halo

PB-12 Series PushButton

	Finish	Description
	Stainless Steel Brushed	Pushbutton, stainless steel, brushed, flat with blue halo

PB-13 Series PushButton

	Finish	Description
	Stainless Steel Brushed	Pushbutton, stainless steel, brushed, concave with blue halo

PB-22T Series PushButton

	Finish	Description
	White on Polished Gold	Pushbutton, white on polished gold, concave with blue halo

PB-30 Series PushButton

	Finish	Description
	Stainless Steel Brushed	Pushbutton, stainless steel, brushed, flat, vandal resistant with blue halo

PB-22J Series PushButton

	Finish	Description
	Stainless Steel Polished	Pushbutton, stainless steel, polished, concave with blue halo

PBR Series PushButton

	Finish	Description
	Stainless Steel Brushed	Pushbutton, Round Flush, stainless steel, Red LED, Red 24V

TPB Series PushButton

	Finish	Description
	Stainless Steel Brushed	Pushbutton, 24V Vandal Resistant, LED illuminated

APPENDIX B: Position Indicators

Red

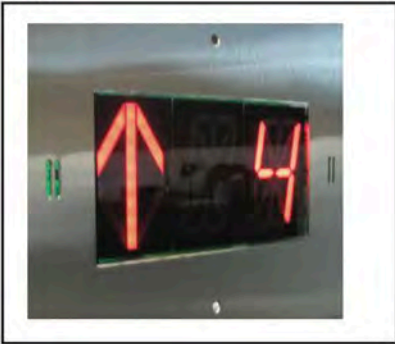

Blue



Green



Orange



White



APPENDIX C: Hall Lantern Fixtures

Horizontal Brushed (#4) Stainless Steel



Horizontal (#8) Bronze (60/40)



Vertical Brushed (#4) Stainless Steel



Vertical (#8) Bronze (60/40)





SEES Pushbuttons

S.E.E.S. #	Description
SEES-FHOP-SMT-001TB-1	Replacement Button, for SEES FHOP-SMT-001TB
SEES-PB-10-B	Pushbutton, stainless steel, brushed, flat, with blue halo, 24 VDC
SEES-PB-10-R	Pushbutton, stainless steel, brushed, flat, with red halo, 24 VDC
SEES-PB-10-W	Pushbutton, stainless steel, brushed, flat, with white halo, 24 VDC
SEES-PB-10-B-06	Pushbutton, stainless steel, brushed, flat, with Blue Halo, 6 VDC
SEES-PB-10-B-12	Pushbutton, stainless steel, brushed, flat, with Blue Halo, 12 VDC
SEES-PB-10-R-06	Pushbutton, stainless steel, brushed, flat, with Red Halo, 6 VDC
SEES-PB-10-R-12	Pushbutton, stainless steel, brushed, flat, with Red Halo, 12 VDC
SEES-PB-10-W-06	Pushbutton, stainless steel, brushed, flat, with White Halo, 6 VDC
SEES-PB-10-W-12	Pushbutton, stainless steel, brushed, flat, with White Halo, 12 VDC
SEES-PB-12-B	Pushbutton, stainless steel, brushed, flat with blue halo
SEES-PB-12-W	Pushbutton, stainless steel, brushed flat with blue halo 24 VDC
SEES-PB-13-B	Pushbutton, stainless steel, polished, concave with blue halo
SEES-PB-22F	Pushbutton, stainless steel, 22mm, No Illumination, IP65 4Pin SPDT Momentary, 1 N.O., 1 N.C. with 8" Leads
SEES-PB-22J-B	Pushbutton, stainless steel, polished, concave with blue halo
SEES-PB-22T-B	Pushbutton, white on polished gold, concave with blue halo
SEES-PB-FIRE-IND-MV	Fire Service Indicator, 24-120V "Fire Hat" Illuminated
SEES-PB-FP-002	Pushbutton, Foot Pedal, "1" & "2" Floor Calls COP Double Button
SEES-PB-FP-DN	Pushbutton, Foot Pedal, "Down" Call Single Button
SEES-PB-FP-UP	Pushbutton, Foot Pedal, "Up" Call Single Button
SEES-PB-TLR-001B	Pushbutton, Touchless Round, Blue LED 31.5mm Silver housing, 24V
SEES-PB-TLS-001B	Pushbutton, Touchless Square, Blue LED 31.5mm Silver housing, 24V



SEES-PB-10-B



SEES-PB-10-R



SEES-PB-10-W



SEES-PB-12-B



SEES-PB-13-B



SEES-PB-22J-B



SEES-PB-22T-B

SEES Pushbuttons

S.E.E.S. #	Description
SEES-PB-513-1-B	Pushbutton, SS Brushed Flat with Blue Halo Marked "1" 24 VDC
SEES-PB-513-2-B	Pushbutton, SS Brushed Flat with Blue Halo Marked "2" 24 VDC
SEES-PB-513-3-B	Pushbutton, SS Brushed Flat with Blue Halo Marked "3" 24 VDC
SEES-PB-513-4-B	Pushbutton, SS Brushed Flat with Blue Halo Marked "4" 24 VDC
SEES-PB-513-ALARM-B	Pushbutton, SS Brushed Flat with Blue Halo Marked "Alarm Bell" 24 VDC
SEES-PB-513-CALL-B	Pushbutton, SS Brushed Flat with Blue Halo Marked "CALL" 24 VDC
SEES-PB-515-CALL-B	Pushbutton, SS Brushed Flat with Blue Halo Marked "CALL" 24 VDC
SEES-PB-513-CH-B	Pushbutton, SS Brushed Flat with Blue Halo Marked "CAR HERE" 24 VDC
SEES-PB-515-CH-B	Pushbutton, SS Brushed Flat with Blue Halo Marked "CAR HERE" 24 VDC
SEES-PBR-FRR-BLANK	Pushbutton, Round Flush, stainless steel, Red LED, Red 24V
SEES-PBR-FRR-BLANK-120	Pushbutton, Round Flush S/S Blank Red LED, Blank 120V
SEES-PBR-FRR-	Pushbutton, Round Flush, stainless steel, Red LED, Red 24V, specify marking i.e. SEES-PBR-FRR-8, shown
SEES-PBR-FRR-AU-120	Pushbutton, Round Flush S/S "Arrow Up" Red LED, Red 120V
SEES-PBR-FRR-AD-120	Pushbutton, Round Flush S/S "Arrow Down" Red LED, Red 120V
SEES-PBR-FRR-CC-120	Pushbutton, Round Flush S/S "Call Cancel" Red LED, Red 120V
SEES-PBR-FRR-DC-120	Pushbutton, Round Flush S/S "Door Close" Red LED, Red 120V
SEES-PBR-FRR-DO-120	Pushbutton, Round Flush S/S "Door Open" Red LED, Red 120V
SEES-PBR-FRR-SPC-120	Pushbutton, Round Flush S/S, Special Marking Red LED, 120V
SEES-PBR-FSI-001	Fire Service Indicator, Round Flush S/S 24V LED, "Fire Hat"
SEES-PBR-FSI-002	Fire Service Indicator, Round Flush S/S 110V LED, "Fire Hat"

SEES Run-Stop Switch

S.E.E.S. #	Description
SEES-PBR-RS-001	Run-Stop Switch, Round Flush S/S 125V 10A Rating



SEES-PBR-FRR-BLANK



SEES-PBR-FRR-08

SEES Vandal Resistant Pushbuttons

S.E.E.S. #	Description
SEES-PB-30-B	Pushbutton , stainless steel, brushed, flat, vandal resistant with blue center dot, 24 VDC
SEES-PB-30-B-06	Pushbutton , stainless steel, brushed, flat, vandal resistant, with Blue Dot Center, 6 VDC
SEES-PB-30-B-12	Pushbutton , stainless steel, brushed, flat, vandal resistant, with Blue Dot Center, 12 VDC
SEES-PB-30-W	Pushbutton , stainless steel, brushed, flat, vandal resistant with white center dot, 24 VDC
SEES-PB-30-W-06	Pushbutton , stainless steel, brushed, flat, vandal resistant, with White Dot Center, 6 VDC
SEES-PB-30-W-12	Pushbutton , stainless steel, brushed, flat, vandal resistant, with White Dot Center, 12 VDC
SEES-PB-30-R	Pushbutton , stainless steel, brushed, flat, vandal resistant with red center dot, 24 VDC
SEES-PB-30-R-06	Pushbutton , stainless steel, brushed, flat, vandal resistant, with Red Dot Center, 6 VDC
SEES-PB-30-R-12	Pushbutton , stainless steel, brushed, flat, vandal resistant, with Red Dot Center, 12 VDC
SEES-PB-30-RING	Pushbutton Retaining Ring , for SEES-PB-30 RetroFit Otis Button 1-1/4" hole
SEES-PB-30A-B	Pushbutton , stainless steel, brushed, flat, vandal resistant with blue center dot, 24 VDC, with reinforcing ring and connector
SEES-PB-30M-CC-W	Pushbutton , stainless steel, Brush Dome Vandal with White Center "Call Cancel" Multi-Volt 24-120V
SEES-PB-30M-MOW-R	Pushbutton , stainless steel, brushed, flat, vandal resistant with red dot, Mowery Retrokit, Multi-Volt 24-120V
SEES-PB-30M-B	Pushbutton , stainless steel, brushed, flat, vandal resistant with blue center & halo, multi-volt 24-120V
SEES-PB-30M-R	Pushbutton , stainless steel, brushed, flat, vandal resistant with red center & halo, multi-volt, 24-120V
SEES-PB-30M-W	Pushbutton , stainless steel, brushed, flat, vandal resistant with white center & halo, multi-volt, 24-120V
SEES-PB-40M-R	Pushbutton , stainless steel, brush projecting concave with red center & halo, multi-volt, 24-120V
SEES-PB-MVCB-B	Contact Block , Multi-Volt Blue 3 LED, 24-120 VAC/DC
SEES-PB-MVCB-G	Contact Block , Multi-Volt Green 3 LED, 24-120 VAC/DC
SEES-PB-MVCB-R	Contact Block , Multi-Volt Red 3 LED, 24-120 VAC/DC
SEES-PB-MVCB-W	Contact Block , Multi-Volt White 3 LED, 24-12 VAC/DC
SEES-PB-MVCB-SL-W	Contact Block , Multi-Volt White 1 LED, 6-120 VAC/DC
TPB-004A	Contact, Pushbutton , Red LED 12-120V multi-volt

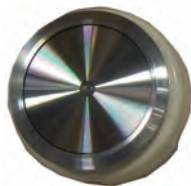

SEES-PB-30-B



SEES-PB-30-R



SEES-PB-30-W



SEES-PB-30M-R



SEES-PB-30M-W



SEES-PB-MVCB-B



SEES-PB-MVCB-R



SEES-PB-MVCB-W



TPB-004A

INNOVATION



INPB-001-1



INPB-002-BLANK



INPB-003-UP-ARROW



INPB-004-IL

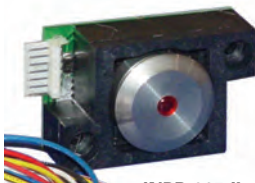

INPB-005-IL

Universal, PB-1

S.E.E.S. #	Description
INPB-001-SERIES	Pushbutton , for Innovation PB-1 style, specify marking, Amber
INPB-001-ALARM	Pushbutton , Innovation PB-1 Marked "Alarm"
INPB-001-FIRE-HAT	Fire Service Indicator , Horizontal, PB-1, 16-120V, Round

Universal, PB -1 ILINE

*Vandal Proof

S.E.E.S. #	Description
INPB-002-UP-ARROW	Pushbutton , for Innovation PB-1, I LINE style, 24 VDC marked UP ARROW, Amber
INPB-002-DOWN-ARROW	Pushbutton , for Innovation PB-1, I LINE style, 24 VDC marked DOWN ARROW, Amber
INPB-002-BLANK	Pushbutton , for Innovation PB-1, I LINE style, 24 VDC BLANK, Amber
INPB-003-UP-ARROW	Button , for Innovation PB-1, I LINE style, 120 VAC/DC marked UP ARROW, Amber
INPB-003-DOWN-ARROW	Pushbutton , for Innovation PB-1, I LINE style, 120 VAC/DC marked DOWN ARROW, Amber
INPB-003-BLANK	Button , for Innovation PB-1, I LINE style, 120 VAC BLANK, Amber

Brusier, PB-23

S.E.E.S. #	Description
INPB-004-IL	Pushbutton , for Innovation PB-23 style, MULTI VOLT, ILLUMINATED RED
INPB-004-NON-IL	Pushbutton , for Innovation PB-23 style, MULTI VOLT, NON ILLUMINATED

Brusier, PB-23 ILINE

S.E.E.S. #	Description
INPB-005-IL	Pushbutton , for Innovation PB-23, I LINE style, 24 VDC ILLUMINATED RED
INPB-005-NON-IL	Pushbutton , for Innovation PB-23, I LINE style, 24 VDC NON ILLUMINATED
INPB-006-IL	Pushbutton , for Innovation PB-23, I LINE style, 120 VAC, ILLUMINATED RED
INPB-006-NON-IL	Pushbutton , for Innovation PB-23, I LINE style, 120 VAC, NON ILLUMINATED

PC Boards for Pushbutton

S.E.E.S. #	O.E.M. #	Description
INPC-001	5941S1CCV4A	PC Board, for Innovation PB-1 style, multi-volt amber color
INPC-001-NON-IL	59413188-2N	PC Board, for Innovation PB 24-120V Multi-volt Non-Illumin
INPC-001A	5941S1CCV4W	PC Board, for Innovation PB-1 style Multi-volt white LED
INPC-001B	59413188-1A	PC Board, for Innovation PB- 24-120V Multi-volt amber LED
INPC-001C	59413188-1R	PC Board, for Innovation PB 24-120V Multi-Volt, Red
INPC-001D	59413315-1R	PC Board, for Innovation PB-S 24-120V Multi-Volt, Red
INPC-001E	59413188-1W	PC Board, for Innovation PB 24-120V Multi-Volt, White
INPC-002	59413320-1A	PC Board, for Innovation PB-1 style, 24 VDC amber color
INPC-003	59413320-1A	PC Board, for Innovation PB-1 style, 120 VAC amber color
INPC-004	5941S1CCV4R	PC Board, for Innovation PB-23 style, multi-volt red color
INPC-005	59413320-1R	PC Board, for Innovation PB-23 style, 24VDC red color
INPC-006	59413320-1R 120	PC Board, for Innovation PB-23 style, 120VAC red color
INPC-007	5941S5CCV5W	PC Board, for Innovation lantern arrow style, white non-vandal
INPC-008	5941S5CCV5R	PC Board, for Innovation lantern arrow style, red non-vandal
INPC-009	5941S5CCV5G	PC Board, for Innovation lantern arrow style, green non-vandal
INPC-010	5941S6CCV5W	PC Board, for Innovation lantern tamper 7 LED style, white vandal
INPC-011	5941S6CCV5R	PC Board, for Innovation lantern tamper 7 LED style, red vandal
INPC-012	5941S6CCV5G	PC Board, for Innovation lantern tamper 7 LED style, green vandal



INPC-001



INPC-001-NON-IL



INPC-001A

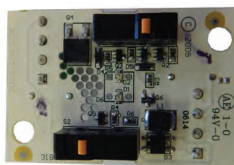

INPC-001B



INPC-002



INPC-003



INPC-004



INPC-005



INPC-006



INPC-001E



INPC-007



INPC-008

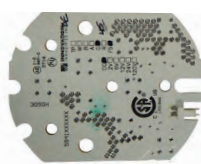

INPC-009

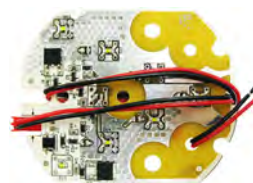

INPC-010



INPC-011

LG International

S.E.E.S. #	Description
LBT-1	Button, LG 21C Specify Marking
LBT-1-ARROW	Button, LG 21C Marked with Arrow
LBT-1-BLANK	Button, LG 21C Blank Marking
LBT-1-DOOR_CLOSE	Button, LG 21C Marked Door Close
LBT-13-ARROW	Button, LG, Round Marked with Arrow



LBT-1-BLANK



LBT-1-DOOR_CLOSE



WA-9-PB-SERIES



WA-9PC-PB-DOOR-CLOSE

Pushbuttons – WA-9 & WA-9PC Series

S.E.E.S. #	O.E.M. #	Description
WA-9-PB-SERIES	WA-9-#	Pushbutton, WA-9 series, specify marking
WA-9PC-PB-SERIES	WA-9PC-#	Pushbutton, WA-9PC series, specify marking



AFHA-001



AFL-001



AFL-002



AFPIL-001



ASPB-BASE



ADPB-1-ADAPTOR



ADPB-1-BLANK



ASPB-1-BLANK



ASPB-1-ARROW



ASPB-201-C



ASPB-201-ARROW



ASPB-SW-001



ASPBL-001



ASPI-1-1

Pushbuttons – Survivor and Survivor +

S.E.E.S. #	O.E.M. #	Description
AFHA-001	ABX007	Hinge Assembly , Adams Car Operating Panel
AFL-001	A954BR4R2	LED Lantern , K-B 120V, Red, LED for Lantern Series A474BL, CL and KL
AFL-002	A954BR4A2	LED Lantern , 120VAC/DC, Amber used with AS451A-02 used with Survivor Base
AFPIL-001	A458-07	D.P.I. Lens , 5.86 x 3.10, Violet
ASPB-BASE	A5451A	Base , Survivor series 2 N.O. with Lampholder
ADPB-1-ADAPTOR		Adaptor , for designer pushbutton
ADPB-1-BLANK	ASA472W-BL	Button , Blank 1/8" with Cap
ADPB-2-BLANK	ASA472DCI-BL	Pushbutton , Adams Designer, Double, "BLANK", Button only, no braille
ASPB-1-ALARM		Pushbutton , Adams Survivor "Alarm" 120V
ASPB-1-ARROW	ASA452CI-ARROW	Button Assembly , 1/8" 2 N.O. INCAND ARROW
ASPB-1-BLANK	ASA452CI	Pushbutton , Survivor Series, 1.375" diameter, specify marking
ASPB-1-DOOR_CLOSE		Pushbutton , Adams Survivor "Door Close" 120V
ASPB-1-DOOR_OPEN		Pushbutton , Adams Survivor "Door Open" 120V
ASPB-201-C	AS450BC3	Clear Cap , for Adams Survivor California Style
ASPB-201-BLANK	AS455W-BL	Button and Halo , Blank
ASPB-201-ARROW	ASA452A-A	Button and Halo , 1/8" Arrow
ASPB-200-BLANK	AS454A-BL	Button and Halo , Blank
ASPB-SW-001	A471A1	Button Assembly , Survivor Stop Switch,
ASPBL-001	A494LW5	LED , Amber 120V, for Survivor pushbuttons
ASPBL-002	A494LRS	LED , Red 120V, for Survivor pushbuttons
ASPI-1-		Lens Only , Survivor Position Indicator, specify marking
ASPI-BASE	A5451D	Base , Survivor Position Indicator Base

Pushbuttons – Survivor and Survivor +

S.E.E.S. #	O.E.M. #	Description
ASPBD-2-ARROW	SM472W2	Button Assembly , Surface mount, Arrow
ASPBS-2-ARROW		Pushbutton , Surface mount "Arrow" 24/28V
ASPBL-200		Lamp Holder , for Survivor
ASB-200	A495G1A2	Lantern , LED PCB K-G24/28V Amber
ASHB-200	ASH460W-BLANK	Clear Cap , or Adams Survivor L
ASHB-201	ASA472W-BLANK	Button and Clear Cap , for Adam Survivor Home Lift
ASHB-202	AS-472-03	Pushbutton , Complete for Adams Survivor Home Lift

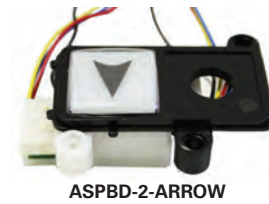

Pushbuttons – Singapore

S.E.E.S. #	O.E.M. #	Description
SPR-MPC-ARROW-RED		Pushbutton , SPR-MPC Button Red LED, Arrow Multi Volt 24/125
SPR-S-BLANK		Pushbutton , Singapore button style round blank multivolt
SPR-S-ARROW-24VAC	SPR-S MK: ARROW 24VAC	Pushbutton , SPS-S style round Arrow 24 VAC
SPR-S-ARROW-24VDC	SPR-S MK: ARROW 24VDC	Pushbutton , SPR-S style round Arrow 24 VDC, 1-5/16" square
SPR-SPC-ARROW-125VAC	SPR-SPC MK: ARROW 125VAC	Pushbutton , SPR-SPC style round Arrow 125 VAC, 1-5/16" square
SPR-SPC-ARROW-24VAC	SPR-SPC MK: ARROW 24VAC	Pushbutton , SPR-SPC style round Arrow 24 VAC, 1-5/16" square
SPR-WAPC-ARROW-125V		Pushbutton , WAPC 125 VAC Horizontal, White with Arrow
SPS-S-ARROW-125VAC	SPS-S MK: ARROW 125VAC	Pushbutton , SPS-S style square Arrow 125 VAC, 1-5/16" square
SPS-S-ARROW-24VAC	SPS-S MK: ARROW 24VAC	Pushbutton , SPS-S style square Arrow 24 VAC, 1-5/16" square
SPS-S-SOLID-ARROW-24VAC		Singapore Style Button , Square, Solid Arrow, 24 VAC
SPS-SPC-ARROW-125VAC	SPS-SPC MK: ARROW 125VAC	Pushbutton , SPS-SPC style square Arrow 125 VAC, 1-5/16" sq.
SPS-SPC-ARROW-24VAC	SPS-SPC MK: ARROW 24VAC	Pushbutton , SPS-SPC style square Arrow 24 VAC, 1-5/16" square

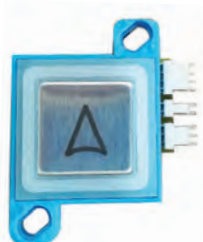
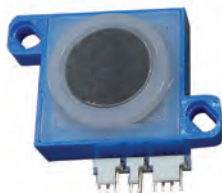

Signal Components

EPCO Circleline

S.E.E.S. #	Description
MIS-196-	Pushbutton Assembly , Complete, Black Halo, Rounded convex clear window magnifies the white button, 1-3/8" diameter, specify marking
MIS-196-#-LED	Pushbutton Assembly LED , Complete, Black Halo, Rounded convex clear window magnifies the white button, 1-3/8" dia., specify marking
MIS-196A	Emergency Stop Switch Assembly , Complete
MIS-198-	Pushbutton , Round, white button with black marking, clear cap included specify marking i.e. MIS-198-ALARM

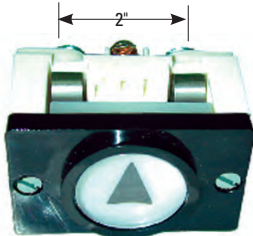

MIS-196-



MIS-196A



MIS-198-ALARM

EPCO Flushline

S.E.E.S. #	Description
MIS-199-	Pushbutton Assembly , Complete, 1-1/4" square beveled black halo with square 7/8" white button marked with black arrow, or specify marking, i.e., MIS-199-1
MIS-199-H	Flushline PB Assembly , Complete, "H"
MIS-199-SPECIAL	Flushline PB Assembly , Complete, Special Markings
MIS-200-	Pushbutton , Square white with black marking, specify marking, i.e., MIS-200-DOOR_OPEN



MIS-199-



MIS-200-2



MIS-200-DOOR OPEN

Dupar Fixtures

S.E.E.S. #	O.E.M. #	Description
DUPB-001	US81	Pushbutton , 24V Dupar N.O. Square SS with Halo Illumination
DUPB-002	US90	Pushbutton , 24V Dupar N.O. Square SS with Laser Cut Legend, Illuminated Halo & Legend
DUPB-003	US90-15	Pushbutton , 24V Dupar N.O. Square SS Button & Halo with Braille, Illuminated Legend
DUPB-004	US84	Pushbutton , 24V Dupar N.O. Round SS Button & Halo "TV" Shape with Halo Illumination
DUPB-005	US89	Pushbutton , 24V Dupar N.O. Rnd SS Button & Halo "TV" Shape w/ Halo & Legend Illumination
DUPB-006	US91	Pushbutton , 24V Dupar N.O. Round SS Button & Halo with Halo & Legend Illumination
DUPB-006-DOOR-CLOSE		Pushbutton , 24V Dupar N.O. Round SS, with Halo & Door Close Illuminated
DUPB-006-DOOR-OPEN	US91	Pushbutton , 24V Dupar N.O. Round SS, with Halo & Door Open Illuminated
DUPB-007	US91-15	Pushbutton , 24V Dupar N.O. Round SS Button & Halo with Braille, Illuminated Legend
DUPB-008	US92	Pushbutton , 24V Dupar N.O. Round Black Plastic Halo, White Button
DUPB-009	US93	Pushbutton , 24V Dupar N.O. Round SS Button Vandal Proof
DUPB-010	US85	Pushbutton , 24V Dupar N.O. Round Black Jumbo 2" x 2" White Legend
DUPB-011	US91BB	Pushbutton , 24V Dupar N.O. Round Button Belly Outside SS, Inner Brass, Red LED, Blank
DUPB-011VM		Fire Service Indicator , Fire Hat Round, 24-120V Vertical
DUPB-011VA		Fire Service Indicator , Fire Hat Round, 120V Vertical
DUPB-011V		Fire Service Indicator , Fire Hat Round, 24V Vertical
DUPB-011HM		Fire Service Indicator , Fire Hat Round, 24-120V Horizontal
DUPB-011HA		Fire Service Indicator , Fire Hat Round, 120V Horizontal
DUPB-011H		Fire Service Indicator , Fire Hat Round, 24V Horizontal
DEWPCB-001		Red LED , 110V, Dewhurst Button Board
DEWCB-001		Contact Block , Dewhurst Button



DUPB-001



DUPB-006



DUPB-006-DOOR-CLOSE



DUPB-006-DOOR-OPEN



DUPB-008



DUPB-009



DUPB-011HA



DEWCB-001

KEY SWITCHES

SEES Key Switches

S.E.E.S. #	Description
MIS-189AD-3	Key Switch, 3 Position, MOM for SEES #3 Key
MIS-189AF	Key Switch, 3 Position MOM J217 Key spring return - Center, K&N Switch
MIS-189F	Key Switch, 2 Position, key removable in both positions, keyed to SEES #2 barrel key
MIS-189F-C	Key Switch, 2 Position, REM 2, Keyed to SEES# 4
MIS-189H	Key Switch, 2 Position, MOM., SPST, # 3 barrel Key
MIS-189H-NC	Key Switch, 2 Position, Mom-Off, SPST NC at 12, with SEES #3 Key
MIS-189K	Key Switch, 2 Position, key removable in both positions, keyed to SEES #3 barrel key
MIS-189L	Key Switch, 2 Position (REMOVE-OFF), key SEES#3
MIS-189S	Key Switch, 2 Pole, 3 Position, remove all with key SEES #10
MIS-189T	Key Switch, 2 Position, spring return screw term, with key SEES#4
MIS-189U	Key Switch, 3 Position, 3 Key pull SP3T with key SEES#4
MIS-189V	Plug Lock, Door Escutcheon with SEES#5 key
MIS-189A	Key Switch, 2 Position 2 Rem with SEES #10 Barrel Key
SEES-FKSW-002	Keyswitch, Fixture, Inspection On-Off 2Pos, 2KP 90Deg SEES#3 Key
SEES-FKSW-003	Keyswitch, Fixture, Indep Serv On-Off 2Pos, 2KP 90Deg SEES#3 Key
SEES-FKSW-004	Keyswitch, Fixture, Light/Fan 1 Spd On-Off 2Pos, 2KP 90Deg SEES#3 Key
SEES-FKSW-005	Keyswitch, Fixture, Light/Fan 2 Spd 3Pos, 3KP 45Deg SEES#3 Key
SEES-FKSW-007	Keyswitch, Fixture, Hoistway Access 3 Pos, MOM 45Deg SEES #2 Key
SEES-FKSW-006	Keyswitch, Fixture, Light, 2 Position, 2KP 90Deg, SEES #4 Key
SEES-FKSW-ACCESS	Keyswitch Assembly, Fixture, Access Enable
SEES-FKSW-STOP	Keyswitch Assembly, Fixture, Stop Switch 2 Pos, 2KP Run-Stop SEES#2 Key
SEES-FKSB-SPECIAL	Keyswitch Bezel, For Fixtures, Special Markings



MIS-189AD-3



MIS-189F-C



MIS-189K



MIS-189L



MIS-189T



MIS-189V



SEES-FKSW-004



SEES-FKSW-ACCESS



SEES-FKSW-STOP

OEM Key Switches

Universal key switch assemblies feature rugged construction for dependable service, extra keys available.

S.E.E.S #	Description
MIS-189-DUO-001	Key Switch, 2 Position, Rmv2, 110V Switch, W7320 Key
MIS-189-DUO-002	Key Switch, 2 Position, Rmv2, 110V Switch, W7336 Key
MIS-189-DUO-002AB	Key Switch, 2 Position MOM with W7336 Key
MIS-189-DUO-003	Key Switch, 2 Position, MOM with W7336 Key
MIS-189-DUO-003AB	Key Switch, 3 Position MOM with W7320 Key
MIS-189-H2111	Key Switch, 2 Position, MOM with H2111 Key
MIS-189-L201	Key Switch, 2 Position, MOM with L201 Key
MIS-189-2007	Key Switch, 2 Position, MOM with 2007 Key
MIS-189-2126	Key Switch, 2 Position, MOM with 2126 Key
MIS-189	Key Switch, 2 Position, spring return to center, key removable in (OFF) position only, keyed H2395, 3/4"
MIS-189A	Key Switch, 2 Position, key removable both positions (ON/OFF), one contact, keyed H2395
MIS-189A-L201	Key Switch, On/Off with L201 Key
MIS-189AA	Key Switch, 2 Pos Off-On, Key H1846, Removable in both
MIS-189AH	Key Switch, 3 Pos, Rmv2 Center & Clockwise A03 Key, Prewired
MIS-189AB	Key Switch, 2 Position, MOM, Key H1846
MIS-189AC	Key Switch, 2 Position, Off-On, Removable in both, H2011 key



MIS-189-DUO-001



MIS-189-DUO-002



MIS-189-DUO-002AB



MIS-189-DUO-003



MIS-189-2007



MIS-189



MIS-189AA



MIS-189AB



MIS-189AC

OEM Key Switches

Universal key switch assemblies feature rugged construction for dependable service, extra keys available.

S.E.E.S. #	Description
MIS-189AD	Key Switch , 3 Position MOM J217 Key Spring Return to Center
MIS-189AD-1848	Key Switch , 3 Position MOM 1848 Key Spring Return to Center
MIS-189AE	Key Switch , 2 Position, Spring Return, uses H2011 key
MIS-189AG	Key Switch , 3 Position, Spring Return to Center, J200 Key
MIS-189AH	Key Switch , 3 Position, Rmv2 Center & Clockwise A03 Key, Prewired
MIS-189B	Key Switch , 2 Position, key removable in (OFF) position only, keyed H2395
MIS-189B-2001	Key Switch , 2 Position R1 Off 2001 Key
MIS-189B-L	Key Switch , SPST 2 Position, Rmv1, Key L206, Off-On
MIS-189B-LL	Key Switch , 2 Position, Rmv2 L203 Key, Off-On
MIS-189C	Key Switch , 2 Position, DPDT, key removable both positions, A03 Key
MIS-189C-H2395	Key Switch , 2 Position, MOM, REM OFF, DPDT, H2395 key
MIS-189D	Key Switch Assembly , removable (ON) position, H2395 key
MIS-189M	Key Switch , 2 Position spring return, key H1848, OEM# 2174-70
MIS-189M-B	Key Switch , 2 Position, 2KP H2007
MIS-189M-A	Key Switch , 2 Position, 2KP H1848
MIS-189M-C	Key Switch , 2 Position, 2KP H2001
MIS-189Z-SWITCH	Switch , 3Pos 45Deg DPDT
MIS-289	Key Switch , 2 Position Momentary with 2001 Key



INNOVATION Key Switches

S.E.E.S. #	O.E.M. #	Description
ASKS-RCB-002		Adams Survivor Keyswitch, Round Code Blue 2 Position, Rmv1, Off-On, EX520
ASKS-SCB-001		Adams Survivor Keyswitch, Square Code Blue Momentary, 2 Pos, Rmv1, Off-On, EX520
ASKS-SCB-002		Adams Survivor Keyswitch, Square Code Blue 2 Position, Rmv1, Off-On, EX520
MIS-189-EX513-A		Key Switch, 2 Position, MOM, EX513 Key with Bracket, 21253
MIS-189-EX513-B	53416113	Key Switch, 2 Position, Rmv2, EX513 Key, Cam Lock
MIS-189-EX516		Key Switch, 2 Position, MOM, Key EX516, Prewired
MIS-189-EX520-2PM1		Key Switch, 2 Position Momentary, Remove at Center EX520 with K&N Switch
MIS-189-EX520-2P1R		Key Switch, 2 Position / 1 Keypull, EX520 with K&N Switch
MIS-189AH		Keyswitch, 3 Position, Remove 2 Center & Clockwise A03 Key, Prewired
MIS-189Y-2	53417114	Cylinder EX514, Hoistway Access, 3 Position, MOM CTR
INKS-001	23074	Keyswitch, Innov Run-Stop, 2 Position, 2Kp, 512 key
INKS-002	12004	Keyswitch, Horizontal Chrome Rotary Access Switch
INKS-003	020019-122	Keyswitch, Horizontal Chrome Flush Mount Inspection Switch
INKS-004	22119	Keyswitch, Horizontal Chrome Projection Mount Inspection Switch
INKSB-RP-ACCESS	025017-002	Keyswitch, Round Projecting Halo Access



EPCO Key Switches

S.E.E.S. #	Description
MIS-189-EX516	Key Switch, 2 Position, MOM, Key EX516, Prewired
MIS-189E	Key Switch, EPCO style lock cylinder suitable for all applications. Flexible 4 position lock, Ace barrel type, key removable in all positions, uses EPCO #1 key
MIS-189E-A	Key, EPCO #1, Ace barrel type
MIS-189E-B	Key, EPCO #2, Ace barrel type
MIS-189E-C	Key, EPCO #11, Ace barrel type
MIS-189F-B	Key Switch, 2 Position, Rmv 2, Keyed to EPCO #2
MIS-189F-D	Key Switch, 2 Position, Rmv 1, Spring Return, Keyed to EPCO #2
MIS-189F-E	Key Switch, 2 Position, Rmv 1, Spring Return, Keyed to EPCO #1
MIS-189F-F	Key Switch, 2 Position, Rmv 2, Keyed to EPCO #1, Prewired
MIS-189F-G	Key Switch, 2 Position, Rmv 2, Keyed to EPCO #12 Key



FIRE SERVICE

Fire Service Key Switches



MIS-189-CTFS-001



MIS-189G-A



MIS-189G-B



MIS-189Q



MIS-189R



MIS-189Y-KS



MIS-189Z-KS

S.E.E.S. #	O.E.M. #	Description
MIS-189-CTFS-001		Fire Service Key Switch , PH I, 3 Pos, Rmv2 with BFD-1 key
MIS-189AH		Keyswitch , 3 Position, Rmv2 Center & Clockwise A03 Key, Prewired
MIS-189G-A		Key Switch , 3 Position, Rmv2, Ph II, FSKS MFD1 Key
MIS-189G-B		Key Switch , 3 Position, Rmv2, Ph I, FSKS MFD1 Key
MIS-189Q	618-1	Key Switch Assembly , Phase I (HALL) 3502, fire service
MIS-189R	618-2	Key Switch Assembly , Phase II (CAR) 3502, fire service
MIS-189Y		Fire Key Switch Assembly , 2642 key, 3 Position, Rmv2, PH I Byp-off-On
MIS-189Y-KS		Fire Key Switch Assembly , 2642, PH1 Hall Cylinder, Bracket and Switch
MIS-189Y-R		Fire Key Switch Assembly , 2642 key, 3 Position, Rmv2, PH I Reset-off-On
MIS-189YY		Fire Key Switch Assembly , 2 Position, Rmv2, Off-On, 2642 key
MIS-189Z-KS		Fire Key Switch Assembly , 2642, PH2 Car Cylinder, Bracket and Switch
MIS-189ZZ		Fire Key Switch Assembly , 2642 key, 2 Position, Rmv1, PH II (Off-On)
SEES-2642-005		Cylinder , Yale Cylinder 2642 PH1, 3 Position, 2KP, Keyed 2642
SEES-2642-006		Cylinder , Yale Cylinder 2642 PH2, 3 Position, 2KP, Keyed 2642
SEES-2642-MC-001		Keyswitch , Monitor Control, PH1, 3 Position, 2KP, Keyed 2642
SEES-2642-MC-002		Keyswitch , Monitor Control, PH2, 3 Position, 2KP, Keyed 2642
SEES-2642-MC-003NB		Keyswitch , Monitor Control, PH1, 2 Position, 2KP, Keyed 2642, No Bezel
SEES-3502-001A		Keyswitch , 7/8" Cylinder PH1, Prewired, 3 Position, 2KP, Keyed 3502
SEES-3502-002A		Keyswitch , 7/8" Cylinder PH2, Prewired, 3 Position, 2KP, Keyed 3502
SEES-3502-005		Cylinder , Yale Cylinder 3502 PH1, 3 Position, 2KP, Keyed 3502
SEES-3502-006		Cylinder , Yale Cylinder 3502 PH2, 3 Position, 2KP, Keyed 3502
SEES-3502-MC-001		Keyswitch , Monitor Control, PH1, 3 Position, 2KP, Keyed 3502
SEES-3502-MC-002		Keyswitch , Monitor Control, PH2, 3 Position, 2KP, Keyed 3502

Fire Service/FEO Key Switches

*All FEO Key Switches use FEO-K1 key and all FEO Key Switches come with 2 FEO-K1 keys



Universal

S.E.E.S. #	Description
FEO-EP-UNV-001	FEO Fire Service Key Switch , Universal Emergency Power, 3 Position, Rmv3, (Auto-1-2)
FEO-UNV-001	FEO Fire Service , Universal PH 1, 3 Position, Rmv2 (Byp-Off-On)
FEO-UNV-001R	FEO Fire Service , Universal PH 1, 3 Position, Rmv2 (Reset-Off-On)
FEO-UNV-002	FEO Fire Service , Universal PH 2, 3 Position, Rmv2 (Off-Hold-On)
FEO-UNV-003	FEO Fire Service , Universal 2 Position, Rmv2 (Off-On)
FEO-UNV-004	FEO Fire Service Key Switch , Universal, 2 Pos, Rmv1, (Off-On)
FEO-UNV-005	FEO Fire Service Key Switch , Universal 3 Pos, Rmv1, Mom RTC (Off-On)



FEO-EP-UNV-001



FEO-UNV-003



FEO-UNV-004

Fire Service Key Functions

* Means the key is removable in this position

PHASE I HALL	BYPASS	OFF *	ON *	PHASE I HALL	RESET	OFF *	ON *
PHASE II CAR	OFF *	HOLD *	ON *	PHASE II CAR	OFF *	HOLD *	ON

■ Prior to the 2000 code, Special orders required for 3 key pull ■ After 2000

Innovation

S.E.E.S. #	Description
FEO-INS-001	FEO Fire Service, Innovation, Square, PH 1, 3 Pos, Rmv 2, (By-Off-On)
FEO-INS-001P	FEO Fire Service, Innovation, Square, I-Line PH 1, 3 Pos, Rmv 2, (By-Off-On)
FEO-INS-001PR	FEO Fire Service, Innovation, Square, I-Line PH 1, 3 Pos, Rmv 2, (Reset-Off-On)
FEO-INS-001R	FEO Fire Service, Innovation, Square, PH 1, 3 Pos, Rmv 2, (Reset-Off-On)
FEO-INS-002	FEO Fire Service, Innovation, Square, PH 2, 3 Pos, Rmv 2 (Off-Hold-On)
FEO-INS-003	FEO Fire Service, Innovation, Square, 2 Pos, Rmv 2, (Off-On)
FEO-INS-004	FEO Fire Service Key Switch, Innovation, Square, 3 Pos, 3Kp, (Auto-Off-On)
FEO-INS-SPECIAL	FEO Fire Service Key Switch, Innovation, Round, Special Order
FEO-INR-001	FEO Fire Service, Innovation, Round, PH 1, 3 Pos, Rmv 2, (By-Off-On)
FEO-INR-001P	FEO Fire Service, Innovation, Round, I-Line PH 1, 3 Pos, Rmv 2, (By-Off-On)
FEO-INR-001PR	FEO Fire Service, Innovation, Round, I-Line PH 1, 3 Pos, Rmv 2, (Reset-Off-On)
FEO-INR-001R	FEO Fire Service, Innovation, Round, PH 1, 3 Pos, Rmv 2, (Reset-Off-On)
FEO-INR-002	FEO Fire Service, Innovation, Round, PH 2, 3 Pos, Rmv 2 (Off-Hold-On)
FEO-INR-003	FEO Fire Service, Innovation, Round, 2 Pos, Rmv2, (Off-On)
FEO-INR-004	FEO Fire Service Key Switch, Innovation Round, 3 Pos, Rmv 3, (1-AUTO-2)



FEO-INR-001PR



FEO-INR-001R



FEO-INR-002



FEO-INR-003



FEO-INS-002

Traditional

S.E.E.S. #	Description
FEO-TR-001H	FEO Fire Service, Traditional, H, PH 1, 3 Pos, Rmv2, (Byp-Off-On)
FEO-TR-001HR	FEO Fire Service, Traditional, H, PH 1, 3 Pos, Rmv2, (Reset-Off-On)
FEO-TR-001V	FEO Fire Service, Traditional, V, PH 1, 3 Pos, Rmv2, (Byp-Off-On)
FEO-TR-001VR	FEO Fire Service, Traditional, V, PH 1, 3 Pos, Rmv2, (Reset-Off-On)
FEO-TR-002H	FEO Fire Service, Traditional, H, PH 2, 3 Pos, Rmv2, (Off-Hold-On)
FEO-TR-002V	FEO Fire Service, Traditional, V, PH 2, 3 Pos, Rmv2, (Off-Hold-On)
FEO-TR-003H	FEO Fire Service, Traditional, H, 2 Position, Rmv2, (Off-On)
FEO-TR-003V	FEO Fire Service, Traditional, Vertical, 2 Position, Rmv2, (Off-On)
FEO-TR-SPECIAL	FEO Fire Service, Traditional, Special, Fill out Form



FEO-TR-001H



FEO-TR-001HR



FEO-TR-001V



FEO-TR-002H



FEO-TR-002V



FEO-TR-003V

Kone / Montgomery

S.E.E.S. #	Description
FEO-KN-001	FEO Fire Service, Kone, PH 1, 3 Position, Rmv2, (Byp-Off-On)
FEO-KN-001R	FEO Fire Service, Kone, PH 1, 3 Position, Rmv2, (Reset-Off-On)
FEO-KN-002	FEO Fire Service, Kone, PH 2, 3 Position, Rmv2, (Off-Hold-On)
FEO-KN-003	FEO Fire Service, Kone, 2 Position, Rmv2, (Off-On)
FEO-MB-001	Fire Service Key Switch, Montgomery PH 1, 3 Pos, Rmv2, (Byp-Off-On)
FEO-MB-002	Fire Service Key Switch, Montgomery PH 2, 3 Pos, Rmv2, (Off-Hold-On)
FEO-MB-003	FEO Fire Service Key Switch, Montgomery 2 Pos, Rmv2, (Off-On-Fire)
FEO-MB-003E	Fire Service Key Switch, Montgomery PH 1, 3 Pos, Rmv2, (Reset-Off-On)
FEO-MBS-001	Fire Service Key Switch, Montgomery Square PH 1, 3 Pos, Rmv2, (Byp-Off-On)
FEO-MBS-002	Fire Service Key Switch, Montgomery Square PH 2, 3 Pos, Rmv2, (Off-Hold-On)



FEO-KN-001



FEO-KN-003



FEO-MB-001



FEO-MB-002

Double Bezel Fire Service Key Switches

S.E.E.S. #	Description
MIS-189W-IMP-DB	Fire Service 3502 Double Bezel, 3 Pos, Rmv2, PH I Byp-Off-On
MIS-189X-IMP-DB	Fire Key Switch Assembly, 3502 Double Bezel 3 Position, Rmv2, PH II Off-Hold-On
MIS-189Y-IMP-DB	Fire Key Switch Assembly, 2642 Key Double Bezel 3 Pos, Rmv2, PH I Byp-Off-On
MIS-189Y-A-IMP-DB	Fire Key Switch Assembly, 255 Key Double Bezel
MIS-189YY-IMP-DB	Fire Key Switch Assembly, 2642 Double Bezel 2 Pos, Rmv2, PH I Off-On
MIS-189Z-IMP-DB	Fire Service Key Switch, 2642 Double Bezel 3 Pos, Rmv2, PH II Off-Hld-On
MIS-189Z-A-IMP-DB	Fire Service Key Switch, 255 Key Double Bezel
MIS-189Z-NORM-IMP-DB	Fire Service Key Switch, 2642 Dbl Bezel 3 Pos, Rmv2, PH II Norm-Hold-Fireman-Service



MIS-189Y-IMP-DB

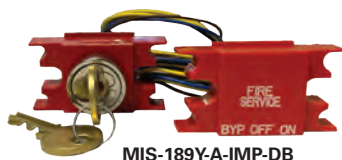

MIS-189Y-A-IMP-DB



MIS-189YY-IMP-DB

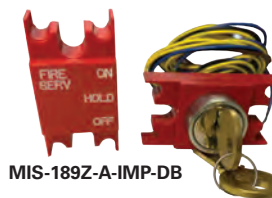

MIS-189Z-A-IMP-DB



MIS-189Z-NORM-IMP-DB

Fire Service Key Switches

S.E.E.S. #	Description
MIS-189W	Fire Key Switch Assembly, 3502 key, 3 Position, Rmv2, PH I Byp-Off-On
MIS-189W-R	Fire Key Switch Assembly, 3502 key, 3 Position, Rmv2, PH I Reset-Off-On
MIS-189X	Fire Key Switch Assembly, 3502 key, 3 Position, Rmv2, PH II Off-Hold-On
MIS-189X-IL	Fire Key Switch Assembly, 3502 key, I-Line 3 Pos, Rmv2, PH II Off-Hold-On, Pancake Switch
MIS-189XX	Fire Key Switch Assembly, 3502 key, 2 Position, Rmv1, PH II (Off-On)
MIS-189Z	Fire Key Switch Assembly, 2642 key, 3 Position, Rmv2, PH II Off-Hold-On
MIS-189Z-BRKT	Bracket, Universal 7/8" "D" flat for Dover & GAL bezels



MIS-189Z-BRKT



MIS-189W



MIS-189X



MIS-189XX



MIS-189Z

Fire Service Key Switch Bezels

S.E.E.S. #	Description
MIS-189Z-BYP-OFF-ON	Bezel, Fire Service PH I, Bypass-Off-On, 7/8" "D" shape
MIS-189Z-OFF-HOLD-ON	Bezel, Fire Service PH II, Off-Hold-On, 7/8" "D" shape
MIS-189Z-OFF-ON	Bezel, Fire Service Off-On 7/8" "D" shape
MIS-189Z-RESET-OFF-ON	Bezel, Fire Service PH I, Reset-Off-On, 7/8" "D" shape
MIS-189Z-SPECIAL	Bezel, Special Marking 1-3/4" O.D. with 7/8" "D" shape
SKB-UNIV-SPECIAL	Schindler Key Switch Bezel, Special Engraving



MIS-189Z-OFF-ON



MIS-189Z-RESET-OFF-ON

Fire Service/FEO Key Switches



FEO-IMR-001H



FEO-IMR-001HR



FEO-IMR-002H



FEO-WB-001



FEO-IMR-003H



FEO-IMS-001H



FEO-IMS-001HR



FEO-IMS-002V



FEO-WB-002



FEO-WB-003



FEO-AU-001R

Impulse

S.E.E.S. #	Description
FEO-IMR-001H	FEO Fire Service, Impulse, Round, H PH 1, 3 Pos, Rmv2, (By-Off-On)
FEO-IMR-001HR	FEO Fire Service, Impulse, Round, H, PH 1, 3 Pos, Rmv2, (Reset-Off-On)
FEO-IMR-001V	FEO Fire Service, Impulse, Round, V PH 1, 3 Pos, Rmv2, (By-Off-On)
FEO-IMR-001VR	FEO Fire Service, Impulse, Round, V, PH 1, 3 Pos, Rmv2, (Reset-Off-On)
FEO-IMR-002H	FEO Fire Service, Impulse, Round, H, PH 2, 3 Pos, Rmv2, (Off-Hold-On)
FEO-IMR-002V	FEO Fire Service, Impulse, Round, V, PH 2, 3 Pos, Rmv2, (Off-Hold-On)
FEO-IMR-003H	FEO Fire Service, Impulse, Round, H, 2 Position, Rmv2, (Off-On)
FEO-IMR-003V	FEO Fire Service, Impulse, Round, V, 2 Position, Rmv2, (Off-On)
FEO-IMR-004H	FEO Fire Service, Impulse Round, Horizontal, 2 Pos, Rmv1, (Off-On)
FEO-IMR-004V	FEO Fire Service, Impulse Round, Vertical, 2 Pos, Rmv1, (Off-On)
FEO-IMR-SPECIAL	FEO Fire Service, Impulse, Square, Special
FEO-IMS-001H	FEO Fire Service, Impulse, Square, H, PH 1, 3 Pos, Rmv2, (By-Off-On)
FEO-IMS-001V	FEO Fire Service, Impulse, Square, V, PH 1, 3 Pos, Rmv2, (By-Off-On)
FEO-IMS-001HR	FEO Fire Service, Impulse, Square, H, PH 1, 3 Pos, Rmv2, (Reset-Off-On)
FEO-IMS-001VR	FEO Fire Service, Impulse, Square, V, PH 1, 3 Pos, Rmv2, (Reset-Off-On)
FEO-IMS-002H	FEO Fire Service, Impulse, Square, H, PH 2, 3 Pos, Rmv2, (Off-Hold-On)
FEO-IMS-002V	FEO Fire Service, Impulse, Square, V, PH 2, 3 Pos, Rmv2, (Off-Hold-On)
FEO-IMS-003H	FEO Fire Service, Impulse, Square, H, 2 Position, Rmv2, (Off-On)
FEO-IMS-003V	FEO Fire Service, Impulse, Square, V, 2 Position, Rmv2, (Off-On)
FEO-IMS-004H	FEO Fire Service, Impulse Square, Horizontal, 2 Pos, Rmv1, (Off-On)
FEO-IMS-004V	FEO Fire Service, Impulse Square, Vertical, 2 Pos, Rmv1, (Off-On)

Westinghouse

S.E.E.S. #	Description
FEO-WB-001	FEO Fire Service, Westinghouse PH 1, 3 Pos, Rmv2, (By-Off-On)
FEO-WB-001R	FEO Fire Service, Westinghouse PH 1, 3 Pos, Rmv2, (Reset-Off-On)
FEO-WB-002	FEO Fire Service, Westinghouse PH 2, 3 Pos, Rmv2, (Off-Hold-On)
FEO-WB-003	FEO Fire Service, Westinghouse, 2 Position, Rmv2, (Off-On)
FEO-WB-SPECIAL	FEO Fire Service, Westinghouse Special, Fill out Form

Dover Aurora

S.E.E.S. #	Description
FEO-AU-001	FEO Fire Service, Aurora, PH 1, 3 Position, Rmv2, (By-Off-On)
FEO-AU-001R	FEO Fire Service, Aurora, PH 1, 3 Position, Rmv2, (Reset-Off-On)
FEO-AU-002	FEO Fire Service, Aurora, PH 2, 3 Position, Rmv2, (Off-Hold-On)
FEO-AU-003	FEO Fire Service, Aurora, 2 Position, Rmv2, (Off-On)

Fire Service/FEO Keys Switches

*All FEO Key Switches use FEO-K1 key and all FEO Key Switches come with 2 FEO-K1 keys.

■ Please see Fire Service Key Function chart on page 347.

US

S.E.E.S. #	Description
FEO-US-001	FEO Fire Service, US, PH 1, 3 Position, Rmv2, (Byp-Off-On)
FEO-US-001R	FEO Fire Service, US, PH 1, 3 Position, Rmv2, (Reset-Off-On)
FEO-US-002	FEO Fire Service, US, PH 2, 3 Position, Rmv2, (Off-Hold-On)
FEO-US-003	FEO Fire Service, US, 2 Position, Rmv2, (Off-On)
FEO-US-SPECIAL	FEO Fire Srv Key Switch, US Round Special Markings and Key Pull
FEO-USB50-001	FEO Fire Service Key Switch, US-B50 PH 1, 3 Position, Rmv2, (Byp-Off-On)
FEO-USS-001	FEO Fire Service, US, Square, PH 1, 3 Pos, Rmv2, (Byp-Off-On)
FEO-USS-002	FEO Fire Service, US, Square, PH 2, 3 Pos, Rmv2, (Off-Hold-On)
FEO-USS-001R	FEO Fire Service, US, Square, PH 1, 3 Pos, Rmv2, (Reset-Off-On)
FEO-USS-003	FEO Fire Service, US, Square, 2 Position, Rmv2, (Off-On)



GAL

S.E.E.S. #	Description
FEO-GAL-001H	FEO Fire Service, GAL, Round, H PH 1, 3 Pos, Rmv2, (Byp-Off-On)
FEO-GAL-001V	FEO Fire Service, GAL, Round, V PH 1, 3 Pos, Rmv2, (Byp-Off-On)
FEO-GAL-001HR	FEO Fire Service, GAL, Round, H PH 1, 3 Pos, Rmv2, (Reset-Off-On)
FEO-GAL-001VR	FEO Fire Service, GAL, Round, V PH 1, 3 Pos, Rmv2, (Reset-Off-On)
FEO-GAL-002H	FEO Fire Service, GAL, Round, H PH 2, 3 Pos, Rmv2, (Off-Hold-On)
FEO-GAL-002V	FEO Fire Service, GAL, Round, V PH 2, 3 Pos, Rmv2, (Off-Hold-On)
FEO-GAL-003H	FEO Fire Service, GAL, Round, H 2 Position, Rmv2, (Off-On)
FEO-GAL-003V	FEO Fire Service, GAL, Round, V 2 Position, Rmv2, (Off-On)
FEO-GAL-004V	FEO Fire Service, GAL, Round, Vertical 2 Pos, Rmv1, (Off-On)
FEO-GAL-004H	FEO Fire Service, GAL, Round, Horizontal 2 Pos, Rmv1, (Off-On)

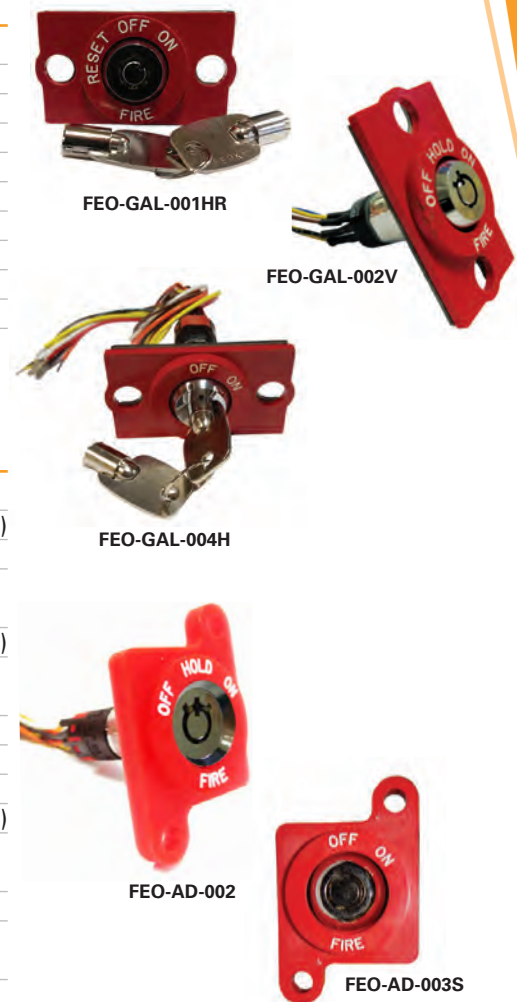

Adams

S.E.E.S. #	Description
ASKS-FEO-KS2-KN	FEO Fire Service Key Switch, Adams, 3 Pos, Rmv2, K&N Switch
FEO-AD-001	FEO Fire Service, Adams, Round PH 1, 3 Position, Rmv2, (Byp-Off-On)
FEO-AD-001R	FEO Fire Service, Adams, Rn PH 1, 3 Pos, Rmv2, (Reset-Off-On)
FEO-AD-001R-KN	FEO Fire Service Key Switch, Adams Round, PH1 3 Position, Rmv2, (Reset-Off-On) Kraus-Naimer
FEO-AD-002	FEO Fire Service, Adams, Round PH 2, 3 Position, Rmv2, (Off-Hold-On)
FEO-AD-002-KN	FEO Fire Service Key Switch, Adams Round, PH2, 3 Position, Rmv2, (Off-Hold-On) Kraus-Naimer
FEO-AD-003	FEO Fire Service, Adams, Round, 2 Position, Rmv2, (Off-On)
FEO-AD-SPECIAL	FEO Fire Service, Adams Round, Special Markings/Keypull
FEO-ADS-001	FEO Fire Service, Adams, Square, PH 1, 3 Pos, Rmv2, (Byp-Off-On)
FEO-ADS-001R	FEO Fire Service, Adams, Square, PH 1, 3 Pos, Rmv2, (Reset-Off-On)
FEO-ADS-001R-KN	FEO Fire Service Key Switch, Adams Square, PH1, 3 Position, Rmv2, (Reset-Off-On), Kraus-Naimer
FEO-ADS-002	FEO Fire Service, Adams, Square, PH 2, 3 Pos, Rmv2, (Off-Hold-On)
FEO-ADS-002-KN	FEO Fire Service Key Switch, Adams Square, PH2, 3 Position, Rmv2, (Off-Hold-On) Kraus-Naimer
FEO-ADS-003	FEO Fire Service, Adams, Square, 2 Position, Rmv2, (Off-On)
FEO-ADS-003S	FEO Fire Service, Adams, Square, 2 Position, Rmv1, (Off-On)
FEO-ADS-SPECIAL	FEO Fire Service, Adams, Square, Special Markings/Keypull

Fire Service/FEO Key Switches

*All FEO Key Switches use FEO-K1 key and all FEO Key Switches come with 2 FEO-K1 keys.

■ Please see Fire Service Key Function chart on pg 347.

Payne

S.E.E.S. #	Description
FEO-PN-001	FEO Fire Service, Payne, PH 1, 3 Position, Rmv2, (By-Off-On)
FEO-PN-001R	FEO Fire Service, Payne, PH 1, 3 Position, Rmv2, (Reset-Off-On)
FEO-PN-002	FEO Fire Service, Payne, PH 2, 3 Position, Rmv2, (Off-Hold-On)
FEO-PN-003	FEO Fire Service, Payne, 2 Position, Rmv2, (Off-On)

Schindler

S.E.E.S. #	Description
FEO-SCH-001	FEO Fire Service, Schindler CT, PH 1, 3 Position, Rmv2, (By-Off-On)
FEO-SCH-001R	FEO Fire Service, Schindler CT, PH 1, 3 Position, Rmv2, (Reset-Off-On)
FEO-SCH-001V	FEO Fire Service, Schindler CT, Vertical Mount PH 1, 3 Pos, Rmv2, (By-Off-On)
FEO-SCH-002	FEO Fire Service, Schindler CT, PH 2, 3 Position, Rmv2, (Off-Hold-On)
FEO-SCH-003	FEO Fire Service, Schindler CT, 2 Position, Rmv2, (Off-On)
FEO-SCK-001	FEO Fire Service, Schindler MT, PH 1, 3 Position, Rmv2, (By-Off-On)
FEO-SCK-001R	FEO Fire Service, Schindler MT, PH 1, 3 Position, Rmv2, (Reset-Off-On)
FEO-SCK-002	FEO Fire Service, Schindler MT, PH 2, 3 Position, Rmv2, (Off-Hold-On)
FEO-SCK-003	FEO Fire Service, Schindler MT, 2 Position, Rmv2, (Off-On)
FEO-SCK-004	FEO Fire Service Key Switch, Schindler MT 2 Position, Rmv1, (Off-On)

Otis

S.E.E.S. #	Description
FEO-OB-001	FEO Fire Service, Otis M1, PH 1, 3 Pos, Rmv2, (By-Off-On)
FEO-OB-001R	FEO Fire Service, Otis M1, PH 1, 3 Pos, Rmv2, (Reset-Off-On)
FEO-OB-001-PW	FEO Fire Service, KeySw, Otis M1 PH 1, 3 Pos, Rmv2, (By-Off-On) Wired
FEO-OB-002	FEO Fire Service, Otis M1, PH 2, 3 Pos, Rmv2, (Off-Hold-On)
FEO-OB-002-PW	FEO Fire Service, KeySw, Otis M1 PH 2, 3 Pos, Rmv2, (Off-Hold-On) Wired
FEO-OB-003	FEO Fire Service, Otis M1, 2 Position, Rmv2, (Off-On)
FEO-OB-SPECIAL	FEO Fire Service, Otis M1, Special
FEO-OB-101	Bezel Red, Bypass-Off-On S5 Series
FEO-OB-101R	Bezel Red, Reset-Off-On M3 Series
FEO-OB-102	Bezel Red, Off-Hold-On S5 Series
FEO-OB-105	Bezel Black, Run-Stop, S5 Series
FEO-OB-105	Bezel Red, Off-Hold-On M3 Series
FEO-OB-RESET	Bezel Black, "Reset", S5 Series with Nut for Elevator Communication Failure
FEO-OBK-001	FEO Fire Service, Otis S5 PH 1, 3 Pos, Rmv2, (Bypass-Off-On)
FEO-OBK-001R	FEO Fire Service, Otis S5 PH 1, 3 Pos, Rmv2, (Reset-Off-On)
FEO-OBK-001LR	FEO Fire Service, Otis S5 PH1, 3 Pos, Rmv2, (Reset-Off-On)-LED
FEO-OBK-001L	FEO Fire Service, Otis S5 PH1, 3 Position, Rmv2, (Bypass-Off-On)-LED
FEO-OBK-002	FEO Fire Service, Otis S5 PH 2, 3 Pos, Rmv2, (Off-Hold-On)
FEO-OBK-101	FEO Fire Service, Otis M3 PH1, 3 Pos, Rmv2, (Bypass-Off-On)
FEO-OBK-101L	FEO Fire Service, Otis M3 PH1, 3 Position, Rmv2, (Bypass-Off-On)-LED
FEO-OBK-101LR	FEO Fire Service, Otis M3 PH1, 3 Position, Rmv2, (Reset-Off-On)-LED
FEO-OBK-101R	FEO Fire Service, Otis M3 PH1, 3 Pos, Rmv2, (Reset-Off-On)
FEO-OBK-102	FEO Fire Service, Otis M3 PH 2, 3 Pos, Rmv2, (Off-Hold-On)
FEO-OBK-LED	LED, Red with Harness for OBK Series



FEO-PN-002



FEO-SCH-001R



FEO-SCK-002



FEO-OB-001



FEO-OB-002



FEO-OB-RESET



FEO-OB-105



FEO-OBK-002-PW



FEO-OBK-001



FEO-OBK-101



FEO-OBK-101R



FEO-OBK-LED

Schindler Fire Service

S.E.E.S. #	Description
SKS-2D	Fire Service Key Switch , MT Phase I, 3 Position, Rmv2, On Off, Reset, with AS100 Key
SKS-4	Fire Service Key Switch , with WDO1 key, PHI Hall
SKS-5	Fire Service Key Switch , with WDO1 key, PHII CAR
SCH-INS-001	Fire Service Key Switch , Innovation, Sq, Schindler MT, 2 Pos, Rmv2, (Off-On)
SCH-INS-002	Fire Service Key Switch , Innovation, Sq, PH 1 3 Pos, Rmv2, AS100 (Bypass-Off-On)



FEO-KBX-001



FEO-KBX-002H

Fire Service Cabinets

S.E.E.S. #	Description
FEO-KBX-001	FEO Key Box , Standard 1-3/8" deep, "FIRE DEPT USE ONLY"
FEO-KBX-002H	FEO Key Box , Horizontal Mount 6-3/8" x 8-1/4 1-3/8" Deep, "FIRE DEPT USE ONLY"
FSC-SC1000	Fire Service Cabinet , Latching Cylinder, SC1000 Key
MIS-FSC-001	Fire Service Cabinet , 2004 MOD Front Opening, FEO Key
MIS-FSC-002	Fire Service Cabinet , 2004 MOD Front/Rear Opening, FEO Key
MIS-FSC-003	Fire Service Cabinet , 2004 MOD Front Opening Specify Zone
MIS-FSC-004	Fire Service Cabinet , 2004 MOD Front/Rear Opening Specify Zone



MIS-FSC-002

Otis

S.E.E.S. #	Description
FEO-OBK-AUTO	FEO Fire Service , Otis M3 Emergency Power, 3P, R3, (1-Auto-2)
FEO-OBK-AUTO-S5	FEO Fire Service , Otis S5 Emergency Power, 3P, R3, (1-Auto-2)

OEM Cylinder

S.E.E.S. #	Description
FEO-KS1	Fire Service Key Switch , FEO PH 1, 3 Position, 2 Pull
FEO-KS1A	Fire Service Key Switch , FEO PH 1 3 Position 2 Key Pull, Flats 9 & 3
FEO-KS1B	Fire Service Key Switch , FEO PH 2, 3 Position 2KP, Ext Slotted Shaft
FEO-KS1-HD	Fire Service Key Switch , FEO 3 Pos, 2 Pull, Phase 1, Heavy Duty
FEO-KS2-HD	Fire Service Key Switch , FEO 3 Pos, 2 Pull, Phase 2, Heavy Duty
FEO-KS2	Fire Service Key Switch , FEO PH 2, 3 Position, 2Pull
FEO-KS2-CC	Fire Service Key Switch , FEO 3 Position, 2Pull, Costant Contact
FEO-KS2A	Fire Service Key Switch , FEO PH 2 3 Position 2 Key Pull, Flats 9 & 3
FEO-KS2B	Fire Service Key Switch , FEO PH 2 3 Position 2KP, Ext Slotted Shaft
FEO-KS3	Fire Service Key Switch , FEO 3 Position, 3 Pull
FEO-KS3A	Fire Service Key Switch , FEO 3 Position 3 Key Pull, Flats 9 & 3
FEO-KS3B	Fire Service Key Switch , FEO 3 Position 3KP, Ext Slotted Shaft
FEO-KS4	Fire Service Key Switch , FEO 2 Position, 2 Key Pull
FEO-KS4A	Fire Service Key Switch , FEO 2 Position, 2KP, Flats 9 & 3
FEO-KS5A	Fire Service Key Switch , FEO 5 Position, 5KP, Flats 9 & 3
FEO-KS6	Fire Service Key Switch , FEO 2 Position, 1KP, Flats 12 & 6
FEO-KS6A	Fire Service Key Switch , FEO 2 Position, 1KP, Flats 9 & 3
FEO-KS6AM-KN	Fire Service Key Switch , FEO 2 Position, 1KP K&N DPST MOM Spring Return to Center, Flats 9 & 3
FEO-KS8M	Fire Service Key Switch , FEO 3 Position, 1KP, Mom RTC, Flats 9-3



FEO-KS1A



FEO-KS2-CC



FEO-KS3A



FEO-KS4



MIS-289E-2389



MIS-289E5-2389



FEO-FSLC2



FEO-FSLC3



AZFS-INR-001



AZFS-INR-002

Emergency Power

S.E.E.S. #	Description
MIS-289E-2389	Key Switch, Emerg Power 4 Position, 4KP, 45Deg, H2389 Key
MIS-289-EPB5-2389	Key Switch, Emerg Power 5 Position 5KP Red Round 1-2-3-4-AUTO, H2389
MIS-289E5-2389	Key Switch, Emerg Power 5 Position 5KP, 45deg, H2389 Key

Latching Cylinder

S.E.E.S. #	Description
FEO-FSLC1	FEO Fire Service Latching Cylinder, for Cabinet
FEO-FSLC2	FEO Fire Service Latching Cylinder, for Cabinet, New Version
FEO-FSLC3	FEO Fire Cabinet Lock, Latch Style
FSC-SC1000	Fire Service Latching Cylinder, SC1000 Key for Cabinet
FSLC-001-3502	Fire Service Latching Cylinder, RH/LH, 3502 Key for Cabinet
FSLC-001L-2642	Fire Service Latching Cylinder, LH, 2642 Key for Cabinet
FSLC-001L-3502	Fire Service Latching Cylinder, LH, 3502 Key for Cabinet
FSLC-001R-2642	Fire Service Latching Cylinder, RH, 2642 Key for Cabinet
FSLC-001R-3502	Fire Service Latching Cylinder, RH, 3502 Key for Cabinet

Arizona Fire Service Key Switches

S.E.E.S. #	Description
AZFB-001	Arizona Fire Univ Bezel, PH I (Bypass-Off-On)
AZFB-002	Arizona Fire Univ Bezel, PH II (Off-Hold-On)
AZFB-003	Arizona Fire Univ Bezel, PH I (Reset-Off-On)
AZFB-004	Arizona Fire Univ Bezel, 2 Position (Off-On)
AZFS-001	Key Switch, Arizona Fire Service PH I, 3 Pos, remove 2 with AZFS key
AZFS-002	Key Switch, Arizona Fire Service PH II, 3 Pos, remove 2 with AZFS key
AZFS-003	Key Switch, Arizona Fire Service PH II, 3 Pos, remove 3 with AZFS key
AZFS-004	Key Switch, Arizona Fire Service 2 Position, remove 2 with AZFS key
AZFS-KEY	Fire Service Key, AZFS, used with all Arizona Fire Service Key Swiches
AZFS-FCS-001	Cabinet Latch, PH II, AZFS Key
AZFS-IMS-002V	Arizona Fire Service KeySwitch, Innovation, Square, Vert PH2, 3Pos, Rmv2, (Off-Hold-On)
AZFS-INR-001	Arizona Fire Service, KeySw, Innov Rn PH 1, 3 Pos, Rmv2, (Byp-Off-On)
AZFS-INR-002	Arizona Fire Service, KeySw, Innov Rn PH 2, 3 Pos, Rmv2, (Off-Hold-On)
AZFS-UNIV-001	Arizona Fire Service, Universal KeySw, 2 Position, Rmv2, (Off-On)
AZFS-UNIV-002	Arizona Fire Service, Univ KeySw PH I, 3 Pos, Rmv2, (Byp-Off-On)
AZFS-UNIV-003	Arizona Fire Service, Univ KeySw PH I, 3 Pos, Rmv2, (Reset-Off-On)
AZFS-UNIV-004	Arizona Fire Service, Univ KeySw PH II, 3 Pos, Rmv2, (Off-Hold-On)
AZFS-UNIV-005	Arizona Fire Service, Univ KeySw PH II, 3 Pos, Rmv2, (Off-Hold-On)



AZFS-001



AZFS-002



AZFS-004

South Carolina Fire Service Key Switches

S.E.E.S. #	Description
MIS-189-FS-A	Fire Service Key, SC1000, used with all South Carolina Fire Service Key Switches
SCFS-001	South Carolina Fire Service, PH I 3/4" Cylinder only 3 Position, 2 Pull
SCFS-002	South Carolina Fire Service, PHII 3/4" Cylinder only 3 Position, 2 Pull
SCFS-003	South Carolina Fire Service, PH I 3/4" Cylinder only 3 Position, 3 Pull
SCFS-004	South Carolina Service, PHII 3/4" Cylinder only 2 Position, 2 Pull
SCFS-001-KN	South Carolina Fire Service Keyswitch, PH I 3PDT with Bracket SC1000
SCFS-002-KN	South Carolina Fire Service Keyswitch, PH II 3PDT with Bracket SC1000
SCFS-GAL-001V	South Carolina Fire Service Keyswitch, GAL, Round, Vertical PH 1, 3 Pos, Rmv2, (Byp-Off-On)
SCFS-IMS-001H	South Carolina Fire Service, Impulse KeySwitch, Square, Horizontal, PH I (BYPASS-OFF-ON) 3P, R2
SCFS-IMS-002V	South Carolina Fire Service, Impulse KeySwitch, Square, Vertical, PHII (OFF-HOLD-ON) 3P, R2
SCFS-KSW-001	South Carolina Fire Service Key Switch, 7/8" Cyl PH 1, 3 Pos, Rmv2, (Byp-Off-On)
SCFS-KSW-002	South Carolina Fire Service Key Switch, 7/8" Cyl PH 2, 3 Pos, Rmv2, (Off-Hold-On)
SCFS-OB-001	South Carolina Fire Service Key Switch, Otis Keyswitch Assembly, PH I M1/Adv (Byp-Off-On)
SCFS-OB-002	South Carolina Fire Service Key Switch, Otis Keyswitch Assembly, PH II M1/Adv (Off-Hld-On)
SCFS-OBK-101	South Carolina Fire Service Key Switch, Otis M3 PH1, 3 Pos, Rmv2, (Bypass-Off-On)
SCFS-OBK-102	South Carolina Fire Service Key Switch, Otis M3 PH 2, 3 Pos, Rmv2, (Off-Hold-On)
SCFS-SCH-001	South Carolina Fire Service Key Switch, Schindler CT PH 1, 3 Position, Rmv2, (Byp-Off-On)
SCFS-SCH-002	South Carolina Fire Service Key Switch, Schindler CT PH 2, 3 Position, Rmv2, (Off-Hold-On)
SCFS-TR-001H	South Carolina Fire Service Key Switch, Traditional Horizontal, PH I (Bypass-Off-On)
SCFS-TR-001HR	South Carolina Fire Service Key Switch, Traditional Horizontal, PH I (Reset-Off-On)
SCFS-TR-002V	South Carolina Fire Service Key Switch, Traditional Vertical, PH II (Off-Hold-On)
SCFS-TR-003H	South Carolina Fire Service Key Switch, Traditional Horizontal, 2P, R2 (Off-On)
SCFS-UNV-001	South Carolina Fire Service, Univ Key Switch PH1, 3 Pos, Rmv2, (BYPASSOFF-ON)
SCFS-UNV-001R	South Carolina Fire Service, Univ Key Switch PH1, 3 Pos, Rmv2, (RESET-OFF-ON)
SCFS-UNV-002	South Carolina Fire Service, Univ Key Switch PHII, 3 Pos, Rmv2, (OFF-HOLD-ON)
SCFS-UNV-003	South Carolina Fire Service, Univ Key Switch, 2 Pos, Rmv2, (OFF-ON)
SCFS-US-001	South Carolina Fire Service Key Switch, U.S. Round PH 1, 3 Pos, Rmv2, (Byp-Off-On)
SCFS-US-002	South Carolina Fire Service Key Switch, U.S. Round PH 2, 3 Pos, Rmv2, (Off-Hold-On)
SCFS-USS-001	South Carolina Fire Service Key Switch, U.S. Square PH 1, 3 Pos, Rmv2, (Byp-Off-On)
SCFS-USS-002	South Carolina Fire Service Key Switch, U.S. Square PH 2, 3 Pos, Rmv2, (Off-Hold-On)

■ For Virginia, Louisiana, Florida refer to the SEES State Catalogs



SCFS-001



SCFS-002



SCFS-001-KN



SCFS-TR-002V



SCFS-USS-002

Car and Hall Accessories



MIS-BB-200



MIS-BB-200-MB8



MIS-BB-201-MB4



MIS-CF-048

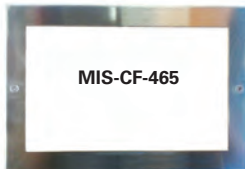

MIS-CF-465



MIS-CF-235M

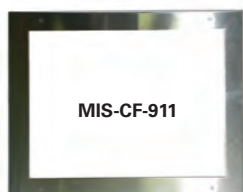

MIS-CF-911

Bulletin Boards

A great addition to any elevator, our stainless steel bulletin board features a hinged access door that closes over four flush mounted screws. The clear, unbreakable plexi-glass window and security access fasteners make this information center vandal resistant. Meets all code requirements. Easy installation, hardware included.

S.E.E.S. #	Description
MIS-BB-200	Bulletin Board , Stainless Steel, 16" x 20" accommodates two standard 8-1/2" x 11" sheets side by side. 16" x 20" O.D., 13-1/2" x 17-1/2" I.D.
MIS-BB-200-MB4	Bulletin Board , 11" x 17", #4 Muntz finish
MIS-BB-200-MB8	Bulletin Board , 11" x 17", #8 Muntz finish (Mirror)
MIS-BB-200-HDW	BB Hardware Kit , FH Screw, Mounting Screws w/ Allen Key, One set per BB
MIS-BB-201	Bulletin Board , as above but for single 8-1/4" x 13-1/2" legal size
MIS-BB-201-MB4	Bulletin Board , 7-1/2" x 10-1/2", #4 Muntz finish
MIS-BB-201-MB8	Bulletin Board , 8" x 10.5", #8 Muntz finish (Mirror)



MIS-CF-235B



MIS-CF-100

Certificate Frames

Vandal resistant certificate frame mounts vertically or horizontally by four screws that are completely hidden from view. Stainless Steel with a clear plexi-glass window.

S.E.E.S. #	Description
MIS-CF-235B	Certificate Frame , 2" x 3" #8 Polished SS, (Georgia)
MIS-CF-100	Certificate Frame , Stainless Steel, 7" x 10", with plexi-glass window 6" x 9"
MIS-207	Replacement Plexi-Glass , 6" x 9", for Certificate Frame
MIS-CF-035	Certificate Frame , 3" x 5" window, Stainless Steel
MIS-CF-046	Certificate Frame , 4" x 6" window, Stainless Steel
MIS-CF-048	Certificate Frame , 4" x 8" window, Stainless Steel
MIS-CF-057	Certificate Frame , 5" x 7" window, Stainless Steel, (TX & AL)
MIS-CF-078	Certificate Frame , 7" x 8" window, Stainless Steel, (Chicago)
MIS-CF-100-MB4	Certificate Frame , 6" x 9" window, #4 Muntz finish
MIS-CF-100-MB8	Certificate Frame , 6" x 9" window, #8 Muntz finish (Mirror)
MIS-CF-235	Certificate Frame , 2" x 3-1/2" window, Stainless Steel, (Georgia)
MIS-CF-235A	Certificate Frame , 2" x 3-1/2" Window, Mirror Finish
MIS-CF-235M	Certificate Frame , 2" x 3-1/2" window, Muntz, (Georgia)
MIS-CF-465	Certificate Frame , 4" x 6-1/2" window, Stainless Steel
MIS-CF-810	Certificate Frame , 8" x 10" window, Stainless Steel
MIS-CF-8514	Certificate Frame , 8-1/2" x 14" window, Stainless Steel
MIS-CF-911	Certificate Frame , 9" x 11" window, Stainless Steel
MIS-CF-1117	Certificate Frame , 11" x 17" #4 Stainless Steel
MIS-CF-100-SCREW	Flat Head Screw , for Certificate Frames, Pack of 25

Mirrors

S.E.E.S. #	Description
MIS-192	Convex Triangular Mirror , 10". Includes hardware
MIS-192A	Rectangular Mirror , 6" x 9". Includes hardware
MIS-192B	Circular Mirror , 8" diameter. Includes hardware



MIS-192



Pad Hooks

S.E.E.S. #	Description
MIS-145A	Pad Hook , aluminum, 1-3/4" L, 1/4-20 threaded stem, lock washer and nut
MIS-145A-B	Pad Hook , 1-3/4" L, 1/4-20 threaded stem, lock washer and nut, brass
MIS-145B	Pad Hook , aluminum 2-3/4" L, 1" spacer, 1/4-20 threaded stem, lock washer and nut
MIS-145B-B	Pad Hook , 2-3/4" L, 1" spacer, 1/4-20 threaded stem, lock washer and nut, brass
MIS-145B-D	Pad Hook , Stainless, 1/2" diameter
MIS-145C	Pad Hook , aluminum, 5/8" L, 10-32 internal thread, 5/8" diameter
MIS-145E	Snap Toggle Bolt , 1/4-20", pack of 50 for cab install
MIS-145F	Pad Hooks , Button Pad Kit, 19 pc, stainless steel
PAD-WSST-AL	Wall Stud , Aluminum #8 self tapping screw
SEES-CPAD-HOOK	Pad Clamp , with hook
SEES-CPAD-SPECIAL	Pads , Cab Wall Protection - Made to Order

■ Elevator cab protective pads made to your specifications. Contact SEES for a quote on your next requirement.



Key Boxes

Polished stainless steel provides an attractive as well as convenient way to secure elevator door keys for emergency use. The bright red glass marked "Fire Department and Emergency Use Only" allows easy, fast access. Easy to install surface mount design, vandal resistant, hardware included.

S.E.E.S. #	Description
MIS-182	Key Box , 10" x 3" x 1-3/8", stainless steel
MIS-182A	Replacement glass for key box, 2-1/2" square red marked "Fire Department and Emergency Use Only"
MIS-182C	Key Box , 2" Deep with Gamewell Key #25460 (Christmas Tree Key)
MIS-182C-A	Key , 25460
MIS-182CH	Key Box , 2" Deep Horizontal with #25460 Key
MIS-182C-L	Cabinet Slam Lock , 25460 Key
MIS-183	Door Key Box , Stainless Steel, 2-1/8" x 3-3/8", 2" Deep, Over Door Mount with K01KK Key



MIS-182



MIS-182C



MIS-182C-L



MIS-182CH



Keys



Keys for Key Switches

S.E.E.S #	Key #
DKS-18B	106
DKS-15B	107
DKS-13B	109
DKS-14B	110
OB-77-255	255
GK-2	1613
GKS-2A	1617
MIS-182C-A	25460
MIS-189Z-B	1620
HK-4	2007
MIS-189Z-A	2642
APB-11F	3500
APB-11G	3501
APB-11H	3502
MIS-189Q-A	3502
DKS-14A	5027
PKS-3A	6304
PKS-8A	6305
PKS-1A	6330
APB-11I	14398
HK-1	3-40079-51
GK-201	0064N
GK-200	0063N
MK-2	A-00
MK-3	A-01
MK-4	A-02
MK-6	A-03
MK-1	A-40
FEO-K1	ACE
HK-5	AE102
ASK-200	AKC0053
ASK-201	AKC0051
ASK-202	AKC0052A
MIS-189P	AUE-5-CCL
AZFS-KEY	AZFS
OB-77-BGM30	BGM30
MIS-183A	CAT 74
DKS-64A	DES-1
DKS-65A	DES-3
DKS-66A	DES-4
DKS-67A	DES-5
DKS-68A	DES-6
DKS-69A	DES-7
DKS-70A	DES-9
DKS-71A	DES-10
OK-001	DUO E1
MIS-189E-A	EPCO #1
MIS-189E-B	EPCO #2
MIS-189E-C	EPCO #11
MK-20	EX-511
MK-10	EX-512
MK-9	EX-513
MK-19	EX-514
MK-8	EX-515
MK-13	EX-516

Keys

S.E.E.S #	Key #
MK-21	EX-520
MIS-289B	F280
MIS-189-F287	F287
WB-29A	F59
GKS-1	G-1601X
GK-1	G1612X
OB-46	GA
OB-46A	GB
DKS-74A	H1846
DKS-75A	H1848
WK-2	H200
DK-1	H-2001
DK-4	H2007
DK-5	H2011
DK-3	H-2111
DK-2	H-2126
WK-1	#H1341
DKS-76A	H-2165
DKS-9A-A	H2192
DKS-12A	H2237
DKS-5A	H-2304
DKS-4A	H-2389
DKS-3A	H-2395
DKS-9B-A	H2399
DKS-6A	H-2454
DKS-9C-A	H2488
DKS-7A	H-2567
DKS-8A	H-2573
DKS-21A	H-5009
DKS-13A	H5074
DKS-15A	H5154
DKS-18A	H5140
APB-11B	H7005
APB-11A	J200
APB-11C	K-7048
APB-11D	K-7049
KK-201	KM825062H01
KK-200	KM825062H02
KK-202	KM825062H03
KK-204	KM825062H04
MK-22	L200
TK-01	L201
TK-02	L202
TK-03	L203
TK-04	L204
TK-05	L205
TK-06	L206
TK-07	L207
TK-08	L208
CJK-001	M702
MIS-189G	MFD1
MK-7	MK2
MK-15	MK-01
MK-16	MK-03
MK-17	MK-04
MK-11	MK-05

S.E.E.S #	Key #
MK-12	MK-03
MK-14	MK-06
MK-18	MK-09
SK-1	AS100
SK-2	100-T
SK-3	OCO-1
SK-4	OCO-4
SK-5	H301
SK-6	WDO1
SK-9	MM101
SK-10	J222
SK-11	J217
SK-13	AS100
MIS-189PT-A	PT01
MIS-189PT-B	PT02
MIS-189PT-C	PT03
MIS-189PT-D	PT04
MIS-189PT-E	PT14
MIS-189F-A	S.E.E.S. #2
MIS-189H-A	S.E.E.S. #3
MIS-189T-A	S.E.E.S. #4
MIS-189V-A	S.E.E.S. #5
MIS-189S-A	S.E.E.S. #10
DKS-202	SC1000
MNK-001	SC1000
MIS-189-FS-A	SC1000
US-KS2A	USE#1
US-KS2B	USE#2
US-KS3A	USE#3
US-KS4A	USE#4
US-KS5A	USE#5
APB-11J	W7049
APB-11	W7336
APB-11E	W7320
PLVK-001	X000010



“DON'T GET
CUFFED
BY LONG LEAD TIMES”

Ask about our Direct Retrofit COPs for
Dover Impulse and Schindler 330A Applications



2 TO 3 WEEK
TURNAROUND
CALL TODAY!



» YOU HAVE THE RIGHT TO REMAIN STAINLESS
HIGH QUALITY | CUSTOM MADE

HOME / RESIDENTIAL LIFTS

QUICK LOCATOR GUIDE

Brakes	364
Car Operating Panels	362-363
Controllers	364
Door Locks	368
Gate Switches	369
Hall Stations	363
Handrails	365
Interlock Switch	368
Lamp Assembly	371
Limit Switches	369
Motors	362
Operators	362
Programming Tool	364
Pumps	362
Pushbutton Components	367
Rollers	367
Selectors	365
Slide Guides	366
Submersible Motor	362
Submersible Pumps	362
Toe Guard	366
Traction Chain Drive	362
Valves	366



Motors



THLM-001

S.E.E.S. #	Description
HL-025	Submersible Motor , Home Lift 3-4 HP, 230 VAC 1Ph 1800 Rpm
HL-025A	Submersible Motor , Home Lift, 5HP, 220 VAC 1Ph 1800 Rpm
HL-025B	Submersible Motor , Hollow Shaft 3-4 HP, 230V 1Ph 1800 Rpm
THLM-001	Traction Chain Drive , motor and gearbox, replacement for Thyssen LEV
HL-025B	Submersible Motor , Hollow Shaft 3-4 HP, 230V 1Ph 1800 Rpm
SEES-HL-023	SEES Motor Assembly , sprockets, bearings and hardware
SEES-HL-023ASEES	SEES Motor Assembly , sprockets, bearings, hardware & brackets



HL-OP-001

Gate Operators

S.E.E.S. #	Description
HL-OP-001	Operator , Home Lift 36" Door Opening
HL-OP-002	Operator , Home Lift 39" Door Opening
HL-OP-003	Operator , Home Lift 43" Door Opening
HL-OP-004	Operator , Home Lift 49" Door Opening
HL-OP-005	Gate Operator Assembly



HL-OP-005

Submersible Pumps

S.E.E.S. #	Description
HL-PMP-001	Submersible Pump , Home Lift 4.2 GPM
HL-PMP-002	Submersible Pump , Home Lift 4.7 GPM
HL-PMP-003	Submersible Pump , Home Lift 5.9 GPM
HL-PMP-004	Submersible Pump , Home Lift 7.1 GPM
HL-PMP-005	Submersible Pump , Home Lift 8.5 GPM
HL-PMP-005-HS	Submersible Pump , Home Lift 8.5 GPM, Hollow Shaft
HL-PMP-006	Submersible Pump , Home Lift 11 GPM
HL-PMP-003-HS	Submersible Pump , Home Lift 5.9 GPM, Hollow Shaft



HL-COP-001



HL-COP-002



HL-COP-003

Car Operating Panels

S.E.E.S. #	Description
HL-COP-001	COP , with emergency light 2 stop
HL-COP-002	COP , with emergency light 3 stop
HL-COP-003	COP , with emergency light 2 stop, with phone
HL-COP-003B	COP , with emergency light 2 stop with phone, Brushed Brass
HL-COP-003-CAT5	COP , with emergency light 2 stop with phone, CAT5 Ready
HL-COP-003DB-CAT5	COP , with Emergency Light 2 Stop with Phone, Dark Bronze CAT5
HL-COP-004	COP , with emergency light 3 stop, with phone
HL-COP-004B	COP , with emergency light 3 stop with phone, brushed brass
HL-COP-004-CAT5	COP , with emergency light 3 stop with phone, CAT5 Ready
HL-COP-004DB-CAT5	COP , with Emergency Light 3 Stop with Phone, Dark Bronze CAT5
HL-COP-007	COP , with Emergency Light 4 Stop
HL-COP-007	COP , with Emergency Light 4 Stop
HL-COP-008	COP , with Emergency Light 4 Stop with phone
HL-COP-008-CAT5	COP , with emergency light 4 stop with phone, CAT5 Ready
HL-COP-008DB-CAT5	COP , with Emergency Light 4 Stop EPhone, Dark Bronze, CAT5 Ready
HL-COP-009	CAT 5 Plug-N-Play PCB , for COP
HL-COP-008DB-CAT5-PI	COP , with Position Ind, 4 Stop with Phone, CAT5



HL-COP-003B



HL-COP-004



HL-COP-004-CAT5

Car Operating Panels

S.E.E.S. #	Description
HL-COP-010-CAT5	COP, with Emergency Light 5 Stop Phone, Off/On KeySw, CAT5
HL-COP-PH-001	KeyPad Phone Line Powered Commander Fixture Mount
HL-COP-PI-001	COP Positon Indicator, with Housing and Lens
HL-COP-PI-PCB	COP Positon Indicator, PCB Only Up to 6 Stops
HL-COP-SPECIAL	Special HomeLift COP, NCNR
HL-SETC	Cable, Stranded Ethernet Cat5 1000' 24Awg White



HL-COP-PI-PCB

SEES Screen

S.E.E.S. #	Description
SEES-SCREEN-HL-001	SEES Screen II, 2 FT Light Curtain Assembly with 24 VDC PS
SEES-SCREEN-HL-001A	SEES Screen II, 2 FT Light Curtain with 110 VAC
SEES-SCREEN-HL-002	SEES Screen II, 5 FT Light Curtain Assembly with 24 VDC PS
SEES-SCREEN-HL-002A	SEES Screen II, 5 FT Light Curtain with 110 VAC
SEES-SCREEN-HL-003	SEES Screen II, 4 FT Light Curtain Assembly with 24 VDC PS
SEES-SCREEN-HL-003A	SEES Screen II, 4 FT Light Curtain with 110 VAC

Hall Stations

S.E.E.S. #	Description
HL-HOP-001	Hall Station, Call
HL-HOP-001B	Hall Station, Call Fixture, Brushed Brass
HL-HOP-001DB	Hall Station, Call Fixture Brushed Dark Bronze
HL-HOP-001-BL	Hall Station, Call Fixture 3" x 5" with SEES Blue PB
HL-HOP-001S	Hall Station, Call Fixture Surface Mount 130mm x 100mm x 8mm, PB513 "Call"
HL-HOP-001SP	Hall Station, Call Fixture, Special
HL-HOP-001-W	Hall Station, Call Fixture 3" x 5" w/ SEES White Halo PB
HL-HOP-002	Hall Station, Call and Car Here
HL-HOP-002B	Hall Station, Call & Car Here Brushed Brass
HL-HOP-002S	Hall Station, Call & Car Here Surface Mount 130mm x 100mm x 8mm, PB513 "Call" & "Car Here"
HL-HOP-002DB	Hall Station, Call & Car Here Dark Bronze
HL-HOP-002L-BL	Hall Station, Call & Car Here Large, 5" x 7" with SEES Blue PB
HL-HOP-002-KS	Hall Station, Call & Car Here with Key Switch On/Off
HL-HOP-003	Hall Station, Single Blue Halo Surface Mount without LCD



HL-HOP-001



HL-HOP-001B



HL-HOP-002



SEES-FHOP-SMT-001TR

Ultra Slim HOP

S.E.E.S. #	Description
SEES-FHOP-SMT-001TB	SEES Fixture HOP, Surface Mount Terminal Thin 310mm x 100mm x 20mm, Blue Metal Button
SEES-FHOP-SMT-001TR	SEES Fixture HOP, Surface Mount Terminal Thin 310mm x 100mm x 20mm, Red Metal Button
SEES-FHOP-SMT-001TW	SEES Fixture HOP, Surface Mount Terminal Thin 310mm x 100mm x 20mm, White Metal Button
SEES-FHOP-SMI-001TR	SEES Fixture HOP, Surface Mount Intermediate Thin 310mm x 100mm x 20mm, Red Metal Button
SEES-FHOP-SMI-001TB	SEES Fixture HOP, Surface Mount Intermediate Thin 310mm x 100mm x 20mm, Blue Metal Button
SEES-FHOP-SMI-001TW	SEES Fixture HOP, Surface Mount Intermediate Thin 310mm x 100mm x 20mm, White Metal Button
SEES-FHOP-FM-SPECIAL	SEES Fixture HOP, Flush Mount Plate Custom Plates Only



SEES-FHOP-SMI-001TW

Bushing

S.E.E.S. #	Description
SEES-CSB-001	Cab Stabilizer Bushing, 1-1/4" O.D. x 1/2" w/ 1/4-20 x 4" Stud
SEES-CSB-002	Cab Stabilizer Bushing, 1-1/4" O.D. x 1/2" 3/8-16 x 4" Stud



SEES-CSB-001



HL-001



HL-001K



HL-002



HL-008



HL-008-EC



HL-101



HL-101-BAT



HL-101-DRIVE



HL-INC-001



HL-LEV-001

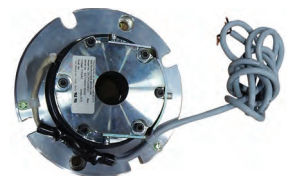

SEES-HL-023B

Power Supplies

S.E.E.S. #	O.E.M. #	Description
HL-PS-001	PS-D-50-12	Power Supply, 12V 50W For Home Lift Cab Light

Controller

S.E.E.S. #	O.E.M. #	Description
HL-001	LEC4M2H2	Hydro Controller, Homelift EMI, 2-4 Stop 3hp
HL-001K		Homelift Hydro Kit Controller, Selector, Program Tool and Tape
HL-001L-05126	LEC6L2S0511MK	Lula Controller, 2 Stop with Selector
HL-001L-05126-PCB		PCB Lula Controller, Tool Attached
HL-002	LEC4M2H2A	Hyd Controller, 2-4 Stop 3hp+Aux Motor Contactor
HL-003	LEC4M2H20	Hydro Controller, 2-4 Stop 5hp
HL-004	LEC4M2H205	Hyd Controller, 2-4 Stop 5hp+Aux Motor Contactor
HL-002-BAT		Battery, Backup for Hydro Controller 425VA, 255Watts 8 Outlets
HL-005	LEC4M2SS 110	Drum Brake, Single Spd 3hp Volts; 110 VAC Brake
HL-005A	LEC4M2SS 230	Drum Brake, Single Spd 3hp Volts; 230 VAC Brake
HL-005B	LEC4M2SS 24	Drum Brake, Single Spd 3hp Volts; 24 VDC Brake
HL-007	LECMHTAL	Controller Board Only, replacement
HL-008	LECP00LWCS	Programming Tool, with case
HL-008-EC		Programming Tool Extension Cable, 3FT Male/Female Ends
HL-100		PCB, Hydro Controller PCB, Hydro Controller
HL-101		Traction Controller, SEES Homelift 230 VAC, 110VAC Brake with F Drive
HL-101-BAT		Battery, Backup for SHE 850VA, 510Watts 8 Outlets
HL-101-BOARD		Replacement Board, Homelift Controller
HL-101-DRIVE		Drive, SHE Homelift Replacement Drive110V
HL-101-FL-DM		SHE Florida Door Monitoring Device Add-on
HL-101A		Controller, Homelift, Special Selector, Limit Sw Kit, Cartop
HL-101-FL-CHIP		SHE Florida Door Inter. Chip Add-on
HL-102		Controller, Homelift PLI, w/ Cartop Box, Landing System and Battery Backup, 120V Brake
HL-103		Controller, Homelift PLI, w/ Cartop Box, Landing System, 220V Brake
HL-103-BAT		Battery, Backup for SHE 220V 1500VA, 900Watts
HL-103-INTERFACE		Interface Cable Assy, for COP Wiring
HL-INC-001		PCB, Remote Assembly UC601
HL-PCB-6L2INT		PCB, Control Board
HL-LEV-001		LEV Controller, Plug & Play replacement with CAT5
HL-LEV-002	2602A-24-230KR	Battery Charger, 24V, 2A
SEES-HL-023B		SEES Motor Brake, brake only
SEES-HL-025		CTW Connecting Rods, Set of (2) w/ Master Links

Selectors

S.E.E.S. #	O.E.M. #	Description
HL-009		Magnet Set , One stop Home Lift
HL-010	LECSELMTG	Selector Mounting Kit , EMI
HL-010B	LECSELMTG	Selector Interface Board
HL-010A	LECSELECTOR KIT	Selector Mounting Kit , EMI Homelift
HL-010-TG		Selector Tape Guide , Each
HL-011		Selector Tape , 2" No Holes used on Home Lift
HL-015	EVPM 110AC	EVPM , 110AC
HL-015A	EVPM 24DC	Valve Coil , 24V Blain Used on Residential Lift
HL-101A	LECSELECTORKIT	Selector Kit , EMI Home Lift
SEES-HL-019		SEES HL Selector Mounting

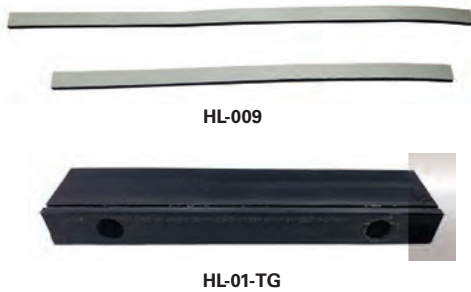

Car Top Boxes

S.E.E.S. #	O.E.M. #	Description
HL-CARTOP-001	LECCTB1	Car Top Box , Basic
HL-CARTOP-002	LECCTB2	Car Top Box , Basic with Buzzer
HL-CARTOP-003	LECCTB5	Car Top Box , Basic with Buzzer & PCB Interface
HL-CARTOP-004		Car Top Box , with Buzzer, COP Interface and Selector PCB Interface
HL-CARTOP-005	LEC6LCTB	Lula Car Top Box , Complete
HL-CARTOP-006	LEC6L2CTBCYIS	Lula Car Top Box , Complete, with inspection station



Handrails

S.E.E.S. #	Description
HL-HR-001	Handrail , 1-1/2" OD Straight End Brushed Stainless Steel, 36" OAL
HL-HR-001B	Handrail , 1-1/2" OD Straight End Brushed Brass, 36" OAL
HL-HR-001DB	Handrail , 1-1/2" OD Straight End Brushed Bronze, 36" OAL
HL-HR-002	Handrail , 1-1/2" OD Bent End Brushed Stainless Steel, 36" OAL
HL-HR-002B	Handrail , 1-1/2" OD Bent End Brushed Brass, 36" OAL
HL-HR-003	Handrail , 1-1/2" Solid Flat Straight End, Brushed Stainless Steel, 36" OAL
HL-HR-004	Handrail , 1-1/2" Solid Flat Bent End, Brushed Stainless Steel, 36" OAL
HL-HR-005	Handrail , 1-1/2" Square Str End, Brushed S/S, 36" OAL
HL-HR-006AB	Handrail , 1-1/2" Antique Brass 36" OAL
HL-HR-SMK-001	Spacer Mounting Kit , for handrail, 304SS, In Cab Removable
HL-HR-SPECIAL	Handrail , Special Order (Quote Required)





HL-020



HL-023



HL-020B



CVP-001



MIS-166D-950HL

Valves

S.E.E.S. #	O.E.M. #	Description
HL-020	RV-1208	Valve, EV100 3/4
HL-021		Valve, EV10 3/4
HL-020A		Blain Valve, EMI Homelift EV100-20 2.0" #2 Flow Guide
HL-020B		Blain Valve, EEMI Homelift EV100 2" #4m 120 VAC No Ball Valve
HL-022	OL75EV	Repair Kit, Blain Valve 3/4" EMI
HL-023	OL15EV	Repair Kit, Blain Valve 1 1/2" Or 2" Valve
CVP-001		Gasket, for Cemco Valve
HL-EV10-75-02-BV		Blain Valve, EV10, 3/4, 115 VAC, #02FG, w/ ball valve
HL-EV10-75-02-BV-DC		Blain Valve, EV10, 3/4, 115 VDC, #02FG, w/ ball valve
HL-EV10-75-03-BV		Blain Valve, EV10, 3/4, 115 VAC, #03FG, w/ ball valve
HL-EV10-75-03-CX-BV		Blain Valve, EV10, 3/4, 115 VAC, #03FG, with CX and ball valve
HL-EV100-75-01-BV		Blain Valve, EV100, 3/4, 115 VAC, #01FG, w/ ball valve
HL-EV100-75-01-CX-BV		Blain Valve, EV100, 3/4, 115 VAC, #01FG, with CX and ball valve
HL-EV100-75-02-BV		Blain Valve, EV100, 3/4, 115 VAC, #02FG, w/ ball valve
HL-EV100-75-02-CX-BV		Blain Valve, EV100, 3/4, 115 VAC, #02FG, with CX and ball valve
HL-EV100-75-03-BV		Blain Valve, EV100, 3/4, 115 VAC, #03FG, w/ ball valve
HL-EV10-75-02-BV-24V		Blain Valve, EV10, 3/4, 24 VDC #02FG, w/ Ball Valve

Relay

S.E.E.S. #	O.E.M. #	Description
HLRP-001		Home Elevator Relay, DPDT 24 VAC, 10A, 125/250VAC
PR-200	RH2B-U AC220/240	Relay, 2PDT, 220-240 VAC Used On Homelift Controller

Capacity Plate

S.E.E.S. #	Description
MIS-166D-950HL	Capacity Plate, 950 LBS with Safety Warning, S.S. 2" x 4"

Guides

S.E.E.S. #	O.E.M. #	Description
HL-SG-001		Home Lift Slide Guide, Nylon 3/4" x 3/4" x 5-5/32, 2 Holes
SEES-HL-001G		SEES HomeLift, Replacement Slide Guides

Cab Parts



SEES-HL-001G

S.E.E.S. #	O.E.M. #	Description
SEES-HL-ENT-001L		SEES Home Lift, L.H. Stack 94" (1) Cab Return + (1) Cab Jam
SEES-HL-ENT-001R		SEES Home Lift, R.H. Stack 94" (1) Cab Return + (1) Cab Jam
SEES-HL-001-05A		Bracket, L-Formed, Extended 10" with Gusset
SEES-HL-001-05B		Bracket, L-Formed, Extended 18" with Gusset
SEES-HL-ENT-003		SEES Home Lift, Hook Bracket Corner Connector, Painted
SEES-HL-ENT-004		SEES Home Lift, Toe Guard 40" Painted
SEES-HL-ENT-005		SEES Home Lift, Header, Cab Return, Painted
SEES-HL-ENT-006		SEES Home Lift, Upper Gate Channel, Painted
SEES-HL-ENT-004A		SEES Home Lift, Toe Guard 5.5 40" W x 5.5" deep, painted
SEES-HL-ENT-005A		SEES Home Lift, header, 44" for cab, powder coated
SEES-HL-ENT-005B		SEES Home Lift, header, 42" for cab, powder coated
SEES-HL-ENT-005C		SEES Home Lift, header, 47" for cab, powder coated

Lamps

S.E.E.S. #	O.E.M. #	Description
ML-1090-G	1090D5	Lamp, 2187 incandescent 28V Green with 5" Ld .65" Bezel / For Homelift
ML-109-R-NEON	1031D1	Lamp, Red 220V neon
ML-1090-R-NEON	1031D1	Lamp, Red 220V Neon



ML-1090-G



ML-1090-R-NEON

Pushbuttons

S.E.E.S. #	O.E.M. #	Description
ASHB-100-23		Button Tactile, 1.75" SQ Marked "23"
ASHB-100-24		Button Tactile, 1.75" SQ Marked "24"
ASHB-200	AS-472-03	Pushbutton, Complete for Adams Survivor Home Lift
ASHB-200	AS-472-03	Pushbutton, Complete for Adams Survivor Home Lift
ASHB-201	ASA472W-BLANK	Button and Clear Cap, for Adam Survivor Home Lift
ASHB-202	ASH460W-BLANK	Clear Cap, for Adams Survivor Lift



ASHB-202



ASHB-200



ASHB-201

Rollers

S.E.E.S. #	O.E.M. #	Description
CEMW-002		Roller, 150mm x 35mm, 6306 Brg 30mm ID
ACW-001	TF-ACR400	Roller, for American Crescent, 4" O.D. x 2" Wide
ACW-002	TF-ACR250	Roller, for American Crescent, 2-1/2 O.D. x 2" Wide
ACW-003	TF-ACR251	Roller, for American Crescent, 2-1/2 O.D. X 1" Wide
HLW-001E		Roller, for OLS, 2-3/8" O.D. x 1-3/16" W w/ Eccentric Hex Shaft
HLW-002	SP-000138	Roller, for Waupaca 80mm with Ecc Hex Shaft
HLW-003	M-005598	Roller, for Waupaca 60mm with Straight Hex Shaft
HLW-004	M-005598	Roller, for Cemco\REI 80mm with Eccentric Hex Shaft
HLW-004A		Roller, for Cemco\REI 80mm x 35mm with Straight Hex Shaft
HLW-005		Roller, for Garaventa 2-1/4" O.D.
HLW-005A		Roller, for Garaventa 2-1/4" O.D. x .765" W, with Straight Shaft
HLW-006		Roller, for Cheney 1-1/2" O.D. x .595" W, with Straight Shaft
HLW-007		Roller, for WC Cantalever Roller 4-7/8" O.D. x 1.375" w/ Ecc Shaft
HLW-008		Hanger Roller, for Savaria 3.375" O.D. x 5/8" with Shaft
HLW-009		Home Lift Roller, 3" O.D. x 1-3/4" W, 1/2" Bore (2) 6201-2RS-8
SEES-HLW-001		SEES S.H.E. Homelift Roller, 3.132" x 1.185"
SEES-HLW-001A		SEES S.H.E. Homelift Roller, 3.132" x 1.185" with eccentric shaft and hardware
REW-001		Roller, for Residential elevator, 3" O.D. x 1-1/2" W with Shaft

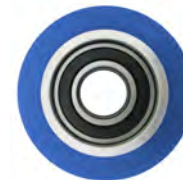

ACW-001

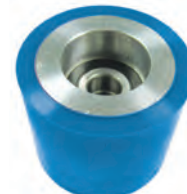

ACW-002

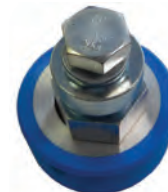

HLW-004



REW-001

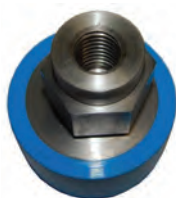

HLW-001E



HLW-006



HLW-002



HLW-007



HLW-003





HL-029

Home Elevator Packages

S.E.E.S. #	Description
SEES-SHE-001	SEES Home Elevator, Custom Complete Package
SEES-SHE-001B	SEES Home Elevator, Rail Package, PLI Controller
SEES-SHE-001C	SEES Home Elevator, Cab Parts, Misc.
SEES-SHE-001E	SEES Home Elevator, Custom 8lb Rail Package
SEES-SHE-001R	SEES Home Elevator, Rail Package, Starter Kit
SEES-SHE-002	SEES Home Elevator, 2 Stop Complete Package
SEES-SHE-003	SEES Home Elevator, 3 Stop Complete Package
SEES-SHE-004	SEES Home Elevator, 4 Stop Complete Package
SEES-SHE-005	SEES Home Elevator, 5 Stop Complete Package
SEES-SHE-006	SEES Home Elevator, 6 Stop Complete Package

SEE S.H.E. order form on page 372 and call with any questions: 800-526-0026



HL-030

Switches and Door Locks

S.E.E.S. #	O.E.M. #	Description
HL-029	4Pos EMDL	Door Lock, Electric 24 VDC, L.H., 4 Pin Series
HL-029-SBK	EMDL750SP	Door Lock, 3/4" Set Back Kit L.H.
HL-030	4Pin EMDL	Door Lock, Electric 24 VDC, R.H., 4 Pin Series
HL-030-SBK	EMDL750SP	Door Lock, 3/4" Set Back Kit R.H.
HL-030-SBK-SS		Door Lock, 3/4" Set Back Kit R.H. Stainless Steel
HL-030	4Pin EMDL	Door Lock, Electric 24VDC. R.H., 4 Pin Series
HL-031	6Pin EMDL	Door Lock, Electric 24VDC. R.H., 6 Pin Series
HL-032	6Pos EMDL	Door Lock, Electric 24VDC. L.H., 6 Pin Series
HL-040	RD12RBS1	Interlock Switch, Residential R.H. AWG 6 Pin Term Conn AC/DC
HL-040A		Interlock Switch, Residential R.H. AWG 4 Pin Term Conn AC/DC
HL-040-SBP		Interlock Switch, 3/4" Setback Plate only for Honeywell Locks
HL-041A		Interlock Switch, Residential L.H. AWG 4 Pin Term Conn AC/DC
HL-041	RD12LBS1	Interlock Switch, Residential L.H. AWG 6 Pin Term Conn AC/DC
HL-042	RD12RBS2	Interlock Switch, Residential R.H. WRGCat 5 conn AC/DC
HL-043	RD12LBS2	Interlock Switch, Residential L.H. WRGCat 5 conn AC/DC
HL-045		Interlock Switch, Smart Lock, R.H./L.H., 6 wire, AC/DC
HL-045A	SLK-800005	Smartlock II, Oil Rubbed Bronze, 6 Wire
HL-045B	SLK-800006	Smartlock II, Stainless, 6 Wire
HL-045C	SLK-800007	Smartlock II, Ivory, 4 Wire
HL-045D	SLK-800008	Smartlock II, Oil Rubbed Bronze, 4 Wire
HL-045E	SLK-800009	Smartlock II, Stainless, 4 Wire
HL-045F	SLK-800010	Smartlock II, Ivory, KLA
HL-045G	SLK-800011	Smartlock II, Oil Rubbed Bronze, KLA
HL-045H	SLK-800012	Smartlock II, Stainless, KLA
HL-045-SBK		Interlock, 3/4" Setback Kit for HL-045 Series
HL-082	311SM2-T	Micro Switch, REI Residential Door Lock, 5A 250 VAC



HL-030-SBK



HL-045

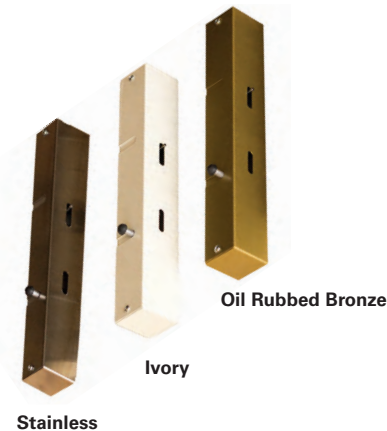

Stainless

Ivory

Oil Rubbed Bronze



HL-040

HL-040A

HL-041

Limit Switches

S.E.E.S. #	O.E.M. #	Description
HL-013	LECLIMSWITCH	Limit Switch
HL-013R		Limit Switch, Home Lift EMI, Manual Reset
HL-014	LECLIMSWKITUF	Limit Switch, Kit, Up & down final with wiring
SEES-HL-018		Limit Switch for SEES Home Lift, with final up/down, (1) Switch
SEES-HL-018A		Limit Switch for SEES Home Lift, with final up/down, brackets only, (2) Cams
SEES-HL-018B		Limit Switch for SEES Home Lift, with final up/down, (2) Switches, (3) Cams



HL-013

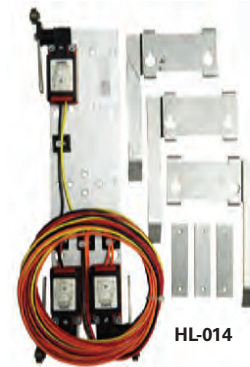

HL-014

Gate Switches

S.E.E.S. #	O.E.M. #	Description
HL-050	GTS100	Gate Switch, Home Lift
HL-050K		Gate Switch Kit, Home Lift with Gate Arm
HL-050K1		Gate Switch Kit, EMI Home Lift with Gate Arm Offset Grey
HL-050K2		Gate Switch Kit, EMI Home Lift with Gate Arm Brown
HL-050K3		Gate Switch Kit, EMI Home Lift with Gate Arm Offset Brown
GDO-16	SW-G-1	Gate Switch, Type G-Complete



HL-050

Gates

S.E.E.S. #	Description
HL-GATE-003VD-1V-CP-NF-RH	Gate, 79" R.H., Vinyl Dark Oak Nickel, 1 Vision, 9Pnl Cent Pin
HL-GATE-001BA-HH-LH	Home Lift Gate, 83" L.H., Brushed Aluminum, Hrd Hinge, TKA Offset
HL-GATE-001CA-NF-LH	Home Lift Gate, 83" L.H., Clear Acrylic, Nickel, TKA Offset
HL-GATE-001CA-NF-RH	Home Lift Gate, 83" R.H., Clear Acrylic, Nickel, TKA Offset
HL-GATE-001VL-NF-LH	Home Lift Gate, 83" L.H., Vinyl Light Oak, Nickel, TKA Offset
HL-GATE-001VL-NF-RH	Home Lift Gate, 83" R.H., Vinyl Light Oak, Nickel, TKA Offset
HL-GATE-001VM-BF-RH	Home Lift Gate, 83" R.H., Vinyl Mahogany, Bronze, TKA Offset
HL-GATE-001VMP-NF-RH	Home Lift Gate, 83" R.H., Vinyl Maple
HL-GATE-001VW-NF-LH	Home Lift Gate, 83" L.H., Vinyl Walnut
HL-GATE-001VW-BF-LH	Home Lift Gate, 83" L.H., Vinyl White, Bronze, TKA Offset
HL-GATE-001VW-BF-RH	Home Lift Gate, 83" R.H., Vinyl White, Bronze, TKA Offset
HL-GATE-002BA-BF-LH	Home Lift Gate, 93" L.H., Full Bronze Acrylic Bronze, TKA Offset
HL-GATE-002BA-BF-RH	Home Lift Gate, 93" R.H., Full Bronze Acrylic Bronze, TKA Offset
HL-GATE-002CA-NF-LH	Home Lift Gate, 93" L.H., Clear Acrylic, Nickel, TKA Offset
HL-GATE-002CA-NF-RH	Home Lift Gate, 93" R.H., Clear Acrylic, Nickel, TKA Offset
HL-GATE-002HVB-NF-LH	Home Lift Gate, 93" L.H., Hard Veneer Birch, Nickel, TKA Offset
HL-GATE-002HVB-NF-RH	Home Lift Gate, 93" R.H., Hard Veneer Birch, Nickel, TKA Offset
HL-GATE-002HVO-NF-LH	Home Lift Gate, 93" L.H., Hard Veneer Oak, Nickel, TKA Offset
HL-GATE-002HVO-NF-RH	Home Lift Gate, 93" R.H., Hard Veneer Oak, Nickel, TKA Offset
HL-GATE-002VC-PG-RH	Home Lift Gate, 93" R.H., Vinyl Cherry Powder Coat Gold, TKA Offset
HL-GATE-002VF-BF-LH	Home Lift Gate, 93" L.H., Clear Acrylic, Bronze Frame
HL-GATE-002VF-BF-RH	Home Lift Gate, 93" R.H., Clear Acrylic, Bronze Frame
HL-GATE-002VL-LH	Home Lift Gate, 93" L.H., Vinyl-Laminate
HL-GATE-002VL-NF-CP-LH	Home Lift Gate, 93" L.H., Vinyl Light Oak, 3 Clear Panel, Nickel, TKA Offset
HL-GATE-002VL-NF-LH	Home Lift Gate, 93" L.H., Vinyl Light Oak, Nickel, TKA Offset
HL-GATE-002VL-NF-RH	Home Lift Gate, 93" R.H., Vinyl Light Oak, Nickel, TKA Offset
HL-GATE-002VVA-NF-LH	Home Lift Gate, 93" L.H., Vinyl Walnut, Nickel, TKA Offset
HL-GATE-002VW-BF-LH	Home Lift Gate, 93" L.H., Vinyl White, Bronze, TKA Offset
HL-GATE-002VW-BF-RH	Home Lift Gate, 93" R.H., Vinyl White, Bronze, TKA Offset
HL-GATE-002VW-NF-LH	Home Lift Gate, 93" L.H., Vinyl White, Nickel, TKA Offset



GDO-16



Accordion Fold Gate



HL-GATE-RMWG-001N

Gates

S.E.E.S. #	Description
HL-GATE-002VW-NF-RH	Home Lift Gate, 93" R.H., Vinyl White, Nickel, TKA Offset
HL-GATE-003VL-NF-LH	Home Lift Gate, 79" L.H., Vinyl Light Oak, Nickel, TKA Offset
HL-GATE-003VL-NF-RH	Home Lift Gate, 79" R.H., Vinyl Light Oak, Nickel, TKA Offset
HL-GATE-004VDO-BF-RH	Home Lift Gate, 83" R.H., Vinyl Dark Oak, Hard Hinge, Bronze, Center Pin
HL-GATE-RMWG-001B	Wrap Gate, 6'8", Brass
HL-GATE-RMWG-001N	Wrap Gate, 6'8", Nickel
HL-GATE-RMWG-001O	Wrap Gate, 6'8", Oil Rubbed Bronze
HL-GATE-RMWG-001U	Wrap Gate, 6'8", Unfinished

Doors

S.E.E.S. #	Description
SEES-HL-CD-83X36-GL-001R	Door Oper and Car Door, 3 Pane glass R.H. with 83" x 36" (2100 x 900mm)
SEES-HL-CD-83X36-SS-001L	Door Oper and Car Door, 3 Pane SS L.H. with 83" x 36" (2100 x 900mm)
SEES-HL-CD-83X36-SS-001R	Door Oper and Car Door, 3 Pane SS R.H. with 83" x 36" (2100 x 900mm)
SEES-HL-CD-95X36-GL-001L	Door Oper and Car Door, 3 Pane glass L.H. with 95" x 36" (2400 x 900mm)
SEES-HL-CD-95X36-GL-001R	Door Oper and Car Door, 3 Pane glass R.H. with 95" x 36" (2400 x 900mm)
SEES-HL-CD-95X36-SS-001L	Door Oper and Car Door, 3 Pane SS L.H. with 95" x 36" (2400 x 900mm)
SEES-HL-CD-95X36-SS-001R	Door Oper and Car Door, 3 Pane SS R.H. with 95" x 36" (2400 x 900mm)
SEES-HL-CD-83X36-GL-001L	Door Oper and Car Door, 3 Pane glass L.H. with 83" x 36" (2100 x 900mm)
SEES-HL-LD-83X36-GL-001L	Landing Door, 3 Panel glass L.H. with 83" x 36" (2100 x 900mm)
SEES-HL-LD-83X36-GL-001R	Landing Door, 3 Panel glass R.H. with 83" x 36" (2100 x 900mm)
SEES-HL-LD-83X36-SS-001L	Landing Door, 3 Panel SS L.H. with 83" x 36" (2100 x 900mm)
SEES-HL-LD-83X36-SS-001R	Landing Door, 3 Panel SS R.H. with 83" x 36" (2100 x 900mm)
SEES-HL-LD-95X36-GL-001L	Landing Door, 3 Panel glass L.H. with 95" x 36" (2400 x 900mm)
SEES-HL-LD-95X36-GL-001R	Landing Door, 3 Panel glass R.H. with 95" x 36" (2400 x 900mm)
SEES-HL-LD-95X36-SS-001L	Landing Door, 3 Panel SS L.H. with 95" x 36" (2400 x 900mm)
SEES-HL-LD-95X36-SS-001R	Landing Door, 3 Panel SS R.H. with 95" x 36" (2400 x 900mm)

Miscellaneous Parts



HL-MAG-001

S.E.E.S. #	Description
HL-MAG-001	Magnetic Latch, for Gate
SEES-HL-002	SEES Home Lift, Motor Mount Plate Only
SEES-HL-003	SEES Home Lift, Top Plate Assembly
SEES-HL-004	SEES Home Lift, Bottom Plate Assembly
SEES-HL-005	SEES Home Lift, Rail Brackets
SEES-HL-006	SEES Home Lift, Counter Weight Guide Assembly
SEES-HL-006A	SEES Home Lift, Counter Weight Guide Assembly with 20 Weights
SEES-HL-006B	SEES Home Lift, Counter Weight Guide Assembly, Extended Sides
SEES-HL-006E	SEES Home Lift, Counter Weight Guide Assembly, 8lb Rails
SEES-HL-007	SEES Home Lift, Counter Weights
SEES-HL-008	SEES Home Lift, Rail Clips
SEES-HL-009	SEES Home Lift, Sling Assembly Complete
SEES-HL-009A	SEES Home Lift, Spring Brake Assembly with Springs and Tie Rods
SEES-HL-009E	SEES Home Lift, Sling Assembly for 8lb Rail Complete
SEES-HL-010	SEES Home Lift, Uni-Strut 8' Long
SEES-HL-011	SEES Home Lift, Chain Guides Set of Two Assemblies
SEES-HL-011A	SEES Home Lift, Chain Guide Set with (2) 30' Chains
SEES-HL-012	SEES Home Lift, Strut Joints
SEES-HL-014C	SEES Home Lift, Sill 4ft Length, Center Groove
SEES-HL-ENT-003A	SEES Home Lift, Hook Bracket 90 deg hook

Chains

S.E.E.S. #	Description
HL-CH-001	Home Lift Chain, 25' 2 Stop #60
HL-CH-002	Home Lift Chain, 35' 3 Stop #60
HL-CH-003	Home Lift Chain, 30' #60

Cab Lighting

S.E.E.S. #	Description
SEES-LED-001K	SEES LED HL Light Kit, Set of 4 bulbs with power supply, chrome finish
SEES-LED-002K	SEES LED HL Light Kit, Set of 4 bulbs with power supply, gold finish
SEES-LED-003K	SEES LED HL Light Kit, Set of 4 bulbs with power supply, white finish
SEES-LED-004K	SEES LED HL Light Kit, Set of 4 bulbs with power supply, black finish
SEES-LED-005K	SEES LED HL Light Kit, Set of 6 pure white with power supply, chrome
SEES-LED-001-DIM	SEES LED Dimmer Module, for SEES-LED-001-PW-B
SEES-LED-001-DIM-B	SEES LED Dimmer Module, with emergency light battery backup
SEES-LED-001-DIM-BK	SEES LED Light and Dimmer Kit, with emergency light battery backup
SEES-LED-001-PW	SEES LED HL LED, pure white
SEES-LED-001-PW-B	SEES LED HL LED, bulb only, pure white
SEES-LED-001-PW-F	SEES LED HL LED, fixture and socket
ML-161-LED-W	Lamp, Elevator Cab White LED 12 VAC/DC
ML-162-LED-W	Lamp, MR16 White LED Dimmable 12 VAC/DC
SEES-HL-CEILING-SP	Cab Ceiling, Special Order with Light Kit



SEES-LED-001-PW



SEES-LED-001-PW-B



SEES-LED-001K



SEES-LED-001K thru 005K



ML-161-LED-W



SEES-LED-005K



SEES-LED-001-PW-F



SEES-LED-001-DIM



ML-162-LED-W

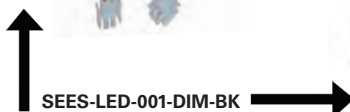

SEES-LED-001-DIM-BK



SEES-LED-001-DIM-B

RESIDENTIAL ELEVATOR QUOTATION



PROJECT STATUS: Quotation Request Order

CUSTOMER INFORMATION

Date:	Cust: PO#:
Name:	
Street:	
City:	
State:	Zip Code:
Phone:	
Fax:	
Email:	

PROJECT INFORMATION

Job Name:	
Location:	
Capacity: _____ lbs.	
Car Travel: _____' - _____"	Pit Depth: _____' - _____"
Speed: _____ fpm	Clear O/H: _____' - _____"
Power: _____ V _____ ϕ _____ Hz.	Landings: _____
Cab Height: _____' - _____"	
Hatch Openings: Front: _____ Rear: _____ Side: _____	
Hoistway: (W): _____' - _____" (D): _____' - _____"	
Platform Size: (W): _____' - _____" (D): _____' - _____"	

CABS:

Type: IN-LINE Type 1 FRONT & REAR Type 2 FRONT & SIDE Type 3 FRONT & SIDE Type 4 IN-LINE (RAILS ON BACK WALL) Type 5

Height: 7' 8'

Wood Selection for Walls: Maple (standard) Light Oak (standard) Medium Oak (premium) Cherry (premium)
 Dark Oak (premium) Stained Cherry (premium) Mahogany (premium) Stained (premium)

GATES:

Accordion Gate: Qty: Power Gate Operator

Vinyl Laminates: Light Oak Dark Oak Cherry Chalk Maple/Birch Antique White
 Walnut Mahogany Beige Black White

Hardwood Finishes: Cherry Oak Walnut Mahogany Maple/Birch

Aluminum: Brushed Aluminum Perforated Aluminum

Hinges: Bright Nickel Bronze Acrylic Vision Panels: Clear Bronze (tint)

Collapsible Metal Scissor Gate: Silver Brass Oil-Rubbed Bronze Bronze

HANDRAILS:

Qty: Bent Ends Straight Bronze Brass Stainless Steel Brushed Stainless Steel Polished

CONTROLS:

Car Operation Panel: Brushed Stainless Steel Brushed Brass Options: Keyswitch

Hall Operation Panel: Brushed Stainless Steel Brushed Brass Options: Keyswitch

Standard Options: "Call" "Call" & "Car Here"

MISCELLANEOUS:

Standard Features: Lower / Upper Final Limit, Pitswitch, Slack chain switch

Options: Spring Buffer Hoistway Door Interlock Key Programming Tool with Case Temporary Run Pendant
 (Needed for first time installers. Can be reused.)



RESIDENTIAL ELEVATOR QUOTATION

HOISTWAY ELEVATION:

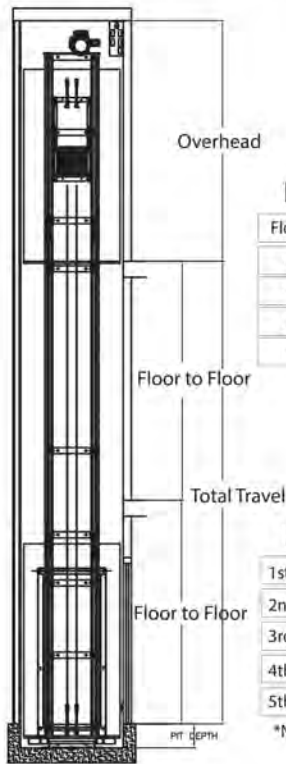

LANDING LOCATION CHART:

Floor	Front	Rear	Side
4			
3			
2			
1			

FLOOR TO FLOOR TRAVEL:

1st to 2nd Flr. _____

2nd to 3rd Flr. _____

3rd to 4th Flr. _____

4th to 5th Flr. _____

5th to 6th Flr. _____

*NOTE: 24" Minimum Floor Travel

HOISTWAY PLAN:

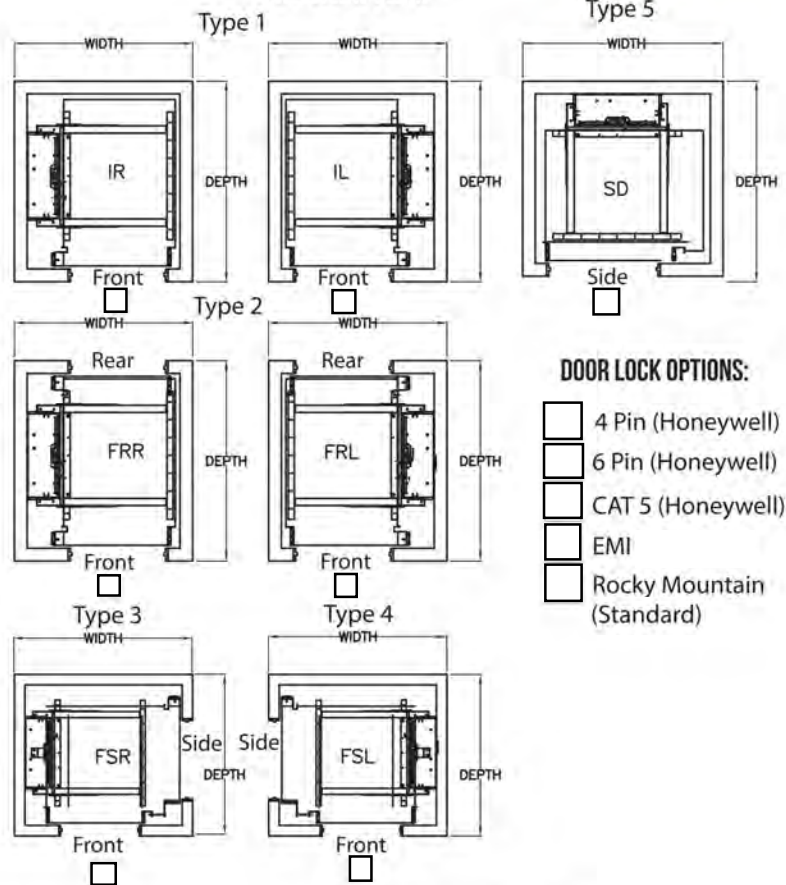

DOOR LOCK OPTIONS:

- 4 Pin (Honeywell)
- 6 Pin (Honeywell)
- CAT 5 (Honeywell)
- EMI
- Rocky Mountain (Standard)

DOOR OPENING ORIENTATION:

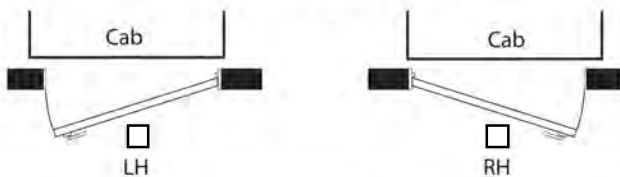

Front Opening: LH RH Size: _____ - _____ W

Rear Opening: LH RH Size: _____ - _____ W

Side Opening: LH RH Size: _____ - _____ W

GATE POCKET ORIENTATION:

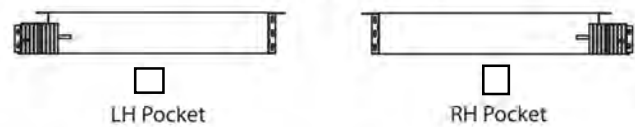

Front Gate Pocket: LH RH

Rear Gate Pocket: LH RH

Side Gate Pocket: LH RH

SHIPPING INFORMATION:

Ship to: _____

Ship Via: Pick-up Carrier

Terms: Pre-paid Collect 3rd Party

Contact Name: _____

Contact Tel #: _____

(24 hours notice before delivery will be indicated unless otherwise noted.)

ADDITIONAL COMMENTS



S.H.E. IS A 10

- 1. Machine RoomLess Elevator
- 2. Smooth ride counter-weighted traction equipment
- 3. No hydraulic oil
- 4. VVVF Drive
- 5. Standard LED lighting
- 6. Car Operating Panel with Emergency Light and Phone
- 7. Real Wood cab
- 8. 950 lb. capacity
- 9. 40 feet per minute
- 10. Made in the USA

CALL US : 800-526-0026



CUSTOMIZE

Choose from a wide range of features and options including wood types, handrails, light fixtures and cab styles. SEES will work with you to bring your vision to life.



MACHINE ROOM-LESS

No hydraulic cylinder, machine room or hydraulic oil. Instead, S.H.E. uses a small electric motor which fits within the hoistway overhead.



ENERGY SAVINGS

Thanks to the efficient motor and traction equipment, S.H.E. energy savings are estimated at 70-80% compared to hydraulic elevators.

WHY A SEES HOME ELEVATOR?

All SEES Home Elevators come with the SEEScreen Electronic Door Detector, designed to ensure maximum passenger safety. The SEEScreen's 94 infrared beams act as an invisible safety curtain across the door entrance. When an obstacle breaks the screen, the sensors detect it and immediately stop the elevator to avoid any accidents.



CONVENIENCE

S.H.E. improves in-home mobility and gives you the freedom to safely access any floor with ease.



INVESTMENT

S.H.E. is a sound investment and will increase your home's value and expand its marketability.



FLEXIBILITY

Purchase the S.H.E. with or without the cab. SEES will work with you to design and build exactly what you want.



MADE IN THE U.S.A.

S.H.E. is constructed from the finest materials at the SEES Modernization Center in Fort Lauderdale.

CONTACT US

By Phone:
800.526.0026
954.971.1115

By Fax:
954.917.7337
Visit Us: www.SEEInc.com



HYDRAULIC EQUIPMENT

QUICK LOCATOR GUIDE

Coils	383
Control Valves	380
Dampeners	382
Drip Ring	400
Hydraulic Ball Valves and Pipe Fittings	385
Hydraulic Filtration and Cooling Systems	390
Hydro Power Unit	378
Hydro Scavenger Pumps	379
Isolation Pads	389
Jack Packing	392-393
Load Weigh Switch	388
Motors	381
Mufflers	382
Oil Coolers	390
Oil Level Switches	388
Oil Pressure Switches	388
Packing Replacement Kits	392-398
Pipe	386
Pipe Joint	400
Portable Filter Cart	390
Pressure Gauges	391
Seals	392-399
SEES Quiet Tank	378
Silencers	381
Submersible Pumps	378-379
Tank Accessories	381
Test Tags	387
Valves	384
Valve Kits	380
Victaulic Seals	398
Worm Gear Seals	399



FEATURES

- » Imperial Motor
- » 50HL/80 starts per hour; up to two motors per tank
- » SEIM Pump
- » Maxton or EECO Valve
- » Muffler standard for removing pulsation & noise
- » Oil level detection via dip stick or sight gauge
- » Isolation between pump, motor assembly and tank
- » Grooved or threaded fittings available

Remarkably Clean:

With SEES manufacturing's unique design, your machine room will remain free of oil spills as all components are inside the tank (including the optional shut-off valve).

OPTIONAL FEATURES

- VISCOSITY TEMPERATURE SWITCH
- PRESSURE GAUGE • LOW PRESSURE SWITCH
- TANK HEATER • FULL DOWN COMPENSATION
- AIR BLADDER MUFFLER • LOAD WEIGHING SWITCH
- OIL LEVEL SIGHT GAUGE • OIL COOLER • THERMOSTAT

COLOR OPTIONS & YOUR COMPANY LOGO AVAILABLE



The SEES submersible power unit has been designed to fit through machine room doorways as small as 25" wide.



Acoustiblok soundproofing option keeps your submersible tank operating on the **QT**



SEES Inc



SEESParts



SEES, Inc.

Always Smooth Sailing



Today's Date: _____

Quote Due Date: _____



Quiet Tank Quote Request Form

Customer: _____ Job Name: _____
 Contact: _____ Location: _____
 Phone: _____ Cell: _____ Required Ship Date: _____
 Fax: _____ Shipping Address: _____
 E-mail: _____

Car Type:

- Single Jack (Direct) Twin Jack Roped
- Twin Jack (Direct) Telescopic
- Single Jack (Roped) In Ground

Tank Type:

- Dry Submersible

Available Options:

- Pressure Gauge Oil Cooler
- Valve Drain Load Weighing
- Low Oil Level Switch Vent Opening
- Oil Level Sight Gauge Tank Heater
- Under Tank Isolation Oil Return Pump
- Low Pressure Switch
- Oil Viscosity Switch
- Conduit Box with Terminal Block
- Enclosure Panels (Dry PU Only)
- Vent Filler Breather / Protected
- Overflow Connection Provisions
-  Sound Absorber

Project Data:

- Down Speed Regulated: Y N
- Muffler: Bladder Chamber Dampener
- Valve: Maxton EECO
- Voltage: 3 Phase 200-208 3 Phase 220-240
- 3 Phase 440-480 3 Phase 575-600

Horsepower: _____

Speed Up: _____ feet per minute

Speed Down: _____ feet per minute

Capacity: _____ lbs. Relief _____ psi

Car Weight: _____ lbs. No Load _____ psi

Gross Load: _____ lbs. Full Load _____ psi

(Capacity + Car Weight)

Travel: _____ feet

Piston DIA: _____ inches

Hertz: 50 60 120

Starts per hour: 80 120

Pipe Size: 2 2.5 3

Tank Outlet: Grooved Threaded

Tank Hand: Right Left

Coil Voltage: 115 VAC 230 VAC 115 VDC

Contact SEES with confidence:

800-526-0026

www.seesinc.com

Fax to 954-917-7337

Email for quote: info@seesinc.com



Submersible Pumps



S.E.E.S. #	Description
SEES-HYD-001	SEES Hydro Power Unit, Small, 41" x 20-3/4" x 38"
SEES-HYD-001A	SEES Hydro Power Unit, Special
SEES-HYD-001-CA	SEES Hydro Power Unit, Special
SEES-HYD-002	SEES Hydro Power Unit, Medium, 48" x 24" x 42"
SEES-HYD-002E	SEES Hydro Power Unit, Empty Tank & Lid
SEES-HYD-003	SEES Hydro Power Unit, Large, 51" x 26-3/4" x 51"
SEES-HYD-003A	SEES Hydro Power Unit, Special Sized per job, 54" x 29" x 56"
SEES-HYD-004	SEES Hydro Power Unit, Special Sized per job, 48" x 26-3/4" x 51"
SEES-HYD-TANK-001	SEES Hydro Power Unit, Tank Only
HYD-DIPSTICK	Dipstick for Oil Level



SEES Residential Power Unit

S.E.E.S. #	Description
SEES-HYD-RES-001	SEES Residential Power Unit, 10 Gal Tank 24" W x 13" D x 18" H
SEES-HYD-RES-002	SEES Residential Power Unit, 20 Gal Tank 24" W x 13" D x 26" H

AcoustiBlok

S.E.E.S. #	Description
HYD-ACOUSTIBLOK	Acoustiblok, Sound Deadening Material, 54" Wide

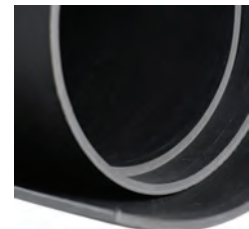

HYD-ACOUSTIBLOK

Please Complete Quiet Tank Request Form on Page 377. For Additional Info, Please Inquire.

Color Options & Your Company Logo Available!



QT as shown is for display only.

Submersible Pumps

S.E.E.S. #	Description
MIS-PMP-39*	Submersible Pump 39 GPM
MIS-PMP-40	Submersible Pump 40 GPM with 1-1/4" Discharge
MIS-PMP-46	Submersible Pump 46 GPM
MIS-PMP-58	Submersible Pump 58 GPM
MIS-PMP-68	Submersible Pump 68 GPM
MIS-PMP-78	Submersible Pump 78 GPM
MIS-PMP-83	Submersible Pump 83 GPM
MIS-PMP-88	Submersible Pump 88 GPM
MIS-PMP-98	Submersible Pump 98 GPM
MIS-PMP-118	Submersible Pump 118 GPM

S.E.E.S. #	Description
MIS-PMP-123	Submersible Pump 123 GPM
MIS-PMP-123-SC	Screen, Replacement for MIS-PMP-123
MIS-PMP-140	Submersible Pump 140 GPM
MIS-PMP-159	Submersible Pump 159 GPM
MIS-PMP-167	Submersible Pump 167 GPM
MIS-PMP-184	Submersible Pump 184 GPM
MIS-PMP-198	Submersible Pump 198 GPM
MIS-PMP-236	Submersible Pump 236 GPM
MIS-PMP-253	Submersible Pump 253 GPM
MIS-PMP-283	Submersible Pump 283 GPM



MIS-PMP-58

*Requires a flange adaptor plate. See page 381.



MIS-PMP-68



MIS-PMP-83



MIS-PMP-98



MIS-PMP-118



MIS-PMP-123



MIS-PMP-140



MIS-PMP-253

Otis Submersible Pump

S.E.E.S. #	O.E.M. #	Description
OM-PMP-59	6962Y26	Pump, 14039C, 59 GPM



MIS-PMP-184



MIS-905A

Hydro Scavenger Pumps

S.E.E.S. #	Description
MIS-905	Scavenger Pump, 115 VAC, 3 Gallon Tank, Oil return sump pump provides a clean and efficient method of saving and recycling hydraulic elevator oil. Sealed submersible pump and motor, compact corrosion proof tank with auto pump operation and oil return filter. Easy, low cost installation. Suitable for permanent or portable use. Maximum length of tubing run: 100 ft. (with 1/2" tubing)
MIS-905A	Scavenger Pump, 115V, Heavy Duty 45 GPH, 100PS 1/4HP 2.8A
MIS-905KIT	Sump Pump Kit
MIS-906	Scavenger Pump, with flood control option. Same superior oil return sump pump, MIS-905, but with flood control option to prevent pumping when water is present in the pit. Maximum length of tubing run: 100 ft. (with 1/2" tubing)
MIS-906	Sump Pump Kit
MIS-906A	Oil Tubing, 100' 1/2" I.D. Flex For Mis-906 and Mis-905
MIS-906B	Replacement Reservoir for MIS-906
MIS-906KIT	Sump Pump, Flood Control Includes 100' Oil Tubing



MIS-905

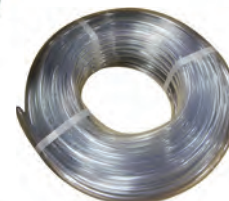

MIS-906A



MIS-906

Dry-Belt Driven Pumps

S.E.E.S. #	O.E.M. #	Description
MIS-DPMP-295	G3D-312	Dry-Belt Driven Pump, 295 GPM
MIS-DPMP-220	G3D-275	Dry-Belt Driven Pump, 220 GPM
MIS-DPMP-190	G3D-250	Dry-Belt Driven Pump, 190 GPM
MIS-DPMP-148	G3D-218	Dry-Belt Driven Pump, 148 GPM
MIS-DPMP-100	G3D-187	Dry-Belt Driven Pump, 100 GPM



MIS-DPMP-295



MIS-906B



Hydraulic Control Valves

Maxton Control Valves

S.E.E.S. #	Description
HYD-MV-001	Control Valve, Maxton UC1A, 2-1/2" Grooved Pump & Jack Ports, 115 VAC Coils
HYD-MV-002	Control Valve, Maxton UC2A, 2-1/2" Grooved Pump & Jack Ports, 115 VAC Coils
HYD-MV-003	Control Valve, Maxton UC4, 2" Grooved Pump & Jack Ports, 115 VAC Coils
HYD-MV-004	Control Valve, Maxton UC4-E1, 2" Grooved Pump & Jack Ports, 115 VAC Coils
HYD-MV-005	Control Valve, Maxton UC4-E2, 2" Grooved Pump & Jack Ports, 115 VAC Coils
HYD-MV-006	Control Valve, Maxton UC4-S2, 2" Grooved Pump & Jack Ports, 115 VAC Coils
HYD-MV-007	Control Valve, Maxton UC4M, 2" Grooved Pump & Jack Ports, 115 VAC Coils
HYD-MV-008	Control Valve, Maxton UC4M-E1, 2" Grooved Pump & Jack Ports, 115 VAC Coils
HYD-MV-009	Control Valve, Maxton UC4M-E2, 2" Grooved Pump & Jack Ports, 115 VAC Coils
HYD-MV-010	Control Valve, Maxton UC4MR, 2" Grooved Pump & Jack Ports, 115 VAC Coils
HYD-MV-011	Control Valve, Maxton UC4MR-E1, 2" Grooved Pump & Jack Ports, 115 VAC Coils
HYD-MV-012	Control Valve, Maxton UC4MR-E2, 2" Grooved Pump & Jack Ports, 115 VAC Coils
HYD-MV-HD-001	Electric Control Valve, Maxton R.H. UC4HD, 2" Grooved Pump/Jack 115 VAC
HYD-MV-HD-002	Electric Control Valve, Maxton L.H. UC4MHD, 2" Grooved Pump/Jack 115 VAC



HYD-MV-007



HYD-MV-005



UV5AT3



UV5AT4



UV5AT5



UV5AT6



UV7B

EECO Valve

S.E.E.S. #	Description
UV5AT3	EECO Valve, 1/2"
UV5AT4	EECO Valve, 3/4"
UV5AT5	EECO Valve, 1"
UV5AT6	EECO Valve, 1-1/4"
UV5A-5627V-3	EECO Valve, Down Piston Kit, Size 3
UV7B	EECO Valve
UV7B9	EECO Valve, UV7B with 9 Port
UV7BCE	EECO Valve, UV7B with 11 Port
UV7BC13	EECO Valve, 13 Port 115V Coils

**Call for sizing*

Valve Kits

S.E.E.S. #	Repair Kit for
MIS-208	UV 3 & 4 EECO Valve
MIS-208A	UV 1 EECO Valve
MIS-208B	UV 1-1/4 EECO Valve
MIS-208C	UV 1-1/2 EECO Valve
MIS-208D	UV 2 EECO Valve
MIS-208E	UV 5, UV 5A EECO Valve
MIS-208F	UV 7 EECO Valve
MIS-208G	UC 1A, 2, 2A Maxton Kit #140
MIS-208G1	UC 3A, 3AM, 4, 4M Maxton Kit #146
MIS-208G2	Maxon Seal Kit for OSV
HYD-RHA-001	Rams Head Assembly, 22" Sheave Diameter, 4 Rope Grooves



MIS-208



MIS-208G

Thyssenkrupp Shut Off Valve

S.E.E.S. #	O.E.M. #	Description
TSOV-001	9884180	Shut Off Valve Assembly, 3"



TSOV-001

Motors, Silencers & Accessories

Submersible Motors

S.E.E.S. #	Description
HYSM-001	Motor, Hydraulic Submersible Pump 20 H.P., 3900 RPM 200V, 80S
HYSM-002	Motor, Hydraulic Submersible Pump 20 H.P., 3900 RPM 230-460V, 80S
HYSM-003	Motor, Hydraulic Submersible Pump 25 H.P., 3900 RPM 200V, 80S
HYSM-004	Motor, Hydraulic Submersible Pump 25 H.P., 3900 RPM 230-460V, 80S
HYSM-005	Motor, Hydraulic Submersible Pump 30 H.P., 3900 RPM 200V, 80S
HYSM-006	Motor, Hydraulic Submersible Pump 30 H.P., 3900 RPM 230-460V, 80S
HYSM-007	Motor, Hydraulic Submersible Pump 40 H.P., 3900 RPM 200V, 80S
HYSM-008	Motor, Hydraulic Submersible Pump 40 H.P., 3900 RPM 230-460V, 80S
HYSM-009	Motor, Hydraulic Submersible Pump 50 H.P., 3900 RPM 200V, 80S
HYSM-010	Motor, Hydraulic Submersible Pump 50 H.P., 3900 RPM 230-460V, 80S
HYSM-011	Motor, Hydraulic Submersible Pump 15 H.P. 200V, 80S
HYSM-012	Motor, Hydraulic Submersible Pump 15 H.P. 230-460V, 80S
HYSM-013	Motor, Hydraulic Submersible Pump 10 H.P. Single Phase, 220 VAC
HYSM-014	Motor, Submersible Hydro 10 H.P. 200V
HYSM-015	Motor, Submersible Hydro 10 H.P. 230/460V
HYSM-016	Motor, Submersible Hydro 30 H.P. 575V
HYSM-017	Motor, Submersible Hydro 40 H.P. 575V, 217EAS040C020
HYSM-A01	Flange Adaptor Plate, Motor to Pump 8-1/8" to 10-1/4"
HYSM-A02	Flange Adaptor Plate, for MIS-PMP-39 & MIS-PMP-46, plate & shaft reducer



HYSM-001 thru -010



HYSM-A01

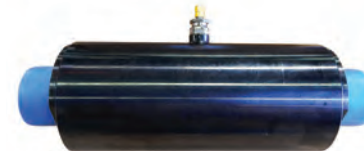

HYD-MUFF-001



HYD-MUFF-003

Silencers

S.E.E.S. #	O.E.M. #	Description
HYD-MUFF-001	19316	Silencer, 2" Grooved x 2" Grooved 100 GMP Bladder Style
HYD-MUFF-002	19317	Silencer, 2" Grooved x 2" Grooved 220 GMP Bladder Style
HYD-MUFF-003	19318	Silencer, 2-1/2" Grv x 2-1/2" Grooved 325 GMP, Bladder Style
HYD-MUFF-004	19319	Silencer, 3" Grooved x 2-1/2" Grooved 360 GMP, Bladder Style
HYD-MUFF-019	MUF-A2G	Silencer, 2" Grooved x 2" Grooved Air Bladder
HYD-MUFF-020	MUF-A2GT	Silencer, 2" Grooved x 2" Threaded Air Bladder



MIS-209



MIS-209A



MIS-209B



MIS-209C

Tank Accessories

S.E.E.S. #	O.E.M. #	Description
HYD-THERM-001		SEES Hydro Thermostat SPDT, Heating and Cooling, 0-120F
MIS-209		Tank Heater, 250 Watt, 120V, preset to maintain oil temp at 110F, fixed has internal thermostat, chord 3.5 feet long
MIS-209A	AAA739H1	Temp Switch, Hydraulic Oil Temp Switch, N.C. 160° Off - 150° On
MIS-209B	AAA2039023	Oil Tank Sensor Assy, Hi-Low oil level and temp
MIS-209C	AAA20390X1	Oil Tank Level Sensor, Hi-Low oil sensor
MIS-209D		Oil Tank Level Sensor, Hi-Low Oil Level, with Mounting
MIS-209E	5061A93H2	Submersible Thermostat - 330A Oil Cooler, Schindler/West

Mufflers & Dampeners



KHM-001



HYD-MUFF-007



MU-2000-1



MU-2000-2



MU-2000-4



HYD-MUFF-021



HYD-TDFS-001

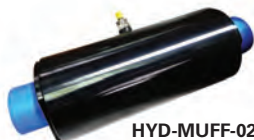

HYD-MUFF-022



HYD-TDFS-003



HYD-TDFS-004



HYD-TDFS-005



HYD-TDFS-006

Mufflers

S.E.E.S. #	O.E.M. #	Description
KHM-001	9817843, USP12000/USP12000019	Muffler, 2" x 2" x 18.5"
KHM-002	9726731	Muffler, 2" Submersible
DV-34	9848836	Core with springs for KHM-001, for 2" and 3" silencer
HYD-MUFF-005	MUF-1.5	Muffler, 1-1/2" threaded 8-5/8" Diameter x 18" OAL
HYD-MUFF-006	MUF-1.5G	Muffler, 1-1/2" grooved 8-5/8" Diameter x 18" OAL
HYD-MUFF-007	MUF-2	Muffler, 2" threaded 8-5/8" Diameter x 18" OAL
HYD-MUFF-008	MUF-2G	Muffler, 2" grooved 8-5/8" Diameter x 18" OAL
HYD-MUFF-009	MUF-2.5	Muffler, 2-1/2" threaded 8-5/8" Diameter x 18" OAL
HYD-MUFF-010	MUF-2.5G	Muffler, 2-1/2" grooved 8-5/8" Diameter x 18" OAL
HYD-MUFF-011	MUF-3	Muffler, 3" threaded 8-5/8" Diameter x 18" OAL
HYD-MUFF-012	MUF-3G	Muffler, 3" grooved 8-5/8" Diameter x 18" OAL
HYD-MUFF-013	MUFS-2	Muffler, 2" threaded 4" Diameter x 20" OAL
HYD-MUFF-014	MUFS-2G	Muffler, 2" grooved 4" Diameter x 20" OAL
HYD-MUFF-015	MUFS-2.5	Muffler, 2-1/2" threaded 4" Diameter x 20" OAL
HYD-MUFF-016	MUFS-2.5G	Muffler, 2-1/2" grooved 4" Diameter x 20" OAL
HYD-MUFF-017	MUFS-3	Muffler, 3" threaded 6" Diameter x 20" OAL
HYD-MUFF-018	MUFS-3G	Muffler, 3" grooved 6" Diameter x 20" OAL

Mufflers by EECO

S.E.E.S. #	Description
MU-2000-1	Muffler, 2" GRV to 2" GRV, 6-5/8" O.D., 11/3-4" long. / 185 GPM max.
MU-2000-2	Muffler, 2" GRV to 2" NPT, 6-5/8" O.D., 11/3-4" long. / 185 GPM max.
MU-2000-4	Muffler, 2" NPT to 2" NPT, 6-5/8" O.D., 11/3-4" long. / 185 GPM max.
MU-2500-1	Muffler, 2-1/2" GRV to 2-1/2" GRV, 8-5/8" O.D., 11/3-4" long. / 260 GPM max.
MU-2500-2	Muffler, 2-1/2" GRV to 2-1/2" NPT, 8-5/8" O.D., 11/3-4" long. / 260 GPM max.
MU-2500-4	Muffler, 2-1/2" NPT to 2-1/2" NPT, 8-5/8" O.D., 11/3-4" long. / 260 GPM max.
MU-2500-5	Muffler, 2-1/2" NPT to 3" GRV, 8-5/8" O.D., 11/3-4" long. / 260 GPM max.
MU-2500-6	Muffler, 2-1/2" GRV to 3" GRV, 8-5/8" O.D., 11/3-4" long. / 260 GPM max.
MU-3000-1	Muffler, 3" GRV to 3" GRV, 8-5/8" O.D., 11/3-4" long. / 350 GPM max.
MU-3000-2	Muffler, 3" GRV to 3" NPT, 8-5/8" O.D., 11/3-4" long. / 350 GPM max.
MU-3000-3	Muffler, 3" NPT to 3" NPT, 8-5/8" O.D., 11/3-4" long. / 350 GPM max.

Dampeners

S.E.E.S. #	Description
HYD-MUFF-021	Dampener, 2" Grooved x 2" Grooved M1 Series
HYD-MUFF-022	Dampener, 2" Grooved x 2" NPT M1 Series
HYD-MUFF-023	Dampener, 2" NPT x 2" NPT M1 Series
HYD-MUFF-024	Dampener, 2-1/2" Grv x 2-1/2" Grv M1 Series
HYD-MUFF-025	Dampener, 2-1/2" Grv x 2-1/2" NPT M1 Series
HYD-MUFF-026	Dampener, 2-1/2" NPT x 2-1/2" NPT M1 Series

Tank Discharge Filtration Systems

S.E.E.S. #	Description
HYD-TDFS-001	Tank Discharge Filter System, 2" Threaded, 125 GPM
HYD-TDFS-002	Tank Discharge Filter System, 2" Grooved, 125 GPM
HYD-TDFS-003	Tank Discharge Filter System, 2" Threaded, 250 GPM
HYD-TDFS-004	Tank Discharge Filter System, 2" Grooved, 250 GPM
HYD-TDFS-005	Tank Discharge Filter System, Replacement Bag 125 GPM
HYD-TDFS-006	Tank Discharge Filter System, Replacement Bag 250 GPM

Coils

EECO Coils

S.E.E.S. #	O.E.M. #	Description
MIS-205	S-651	EECO Coil, 110 VAC, UV7
MIS-205A	S-652	EECO Coil, 208 VAC, UV7
MIS-205B	S-653	EECO Coil, 220 VAC, UV7
MIS-205C	S-752	EECO Coil, 110 VDC, UV7
MIS-205D	S-753	EECO Coil, 220 VDC, UV7
MIS-205F	S463	EECO Coil, 230 VAC, UV5
MIS-205G	S-461	EECO Coil, 1110 VAC, UV5



MIS-205

MIS-205A

S.E.E.S. #	O.E.M. #	Description
GMVC-001	S-651	Coil, 110 VAC 3010 EN
GMVC-002		Coil, 110 VAC / 12 VDC



GMVC-001

GMVC-002

Hydraulic Oil

S.E.E.S. #	Description
MIS-100D	Hydraulic Oil, 1 gallon. Specially formulated for all types of hydraulic elevator pistons
MIS-100D5	Hydraulic Oil, AW32 5 gallon pail
MIS-100D55	Hydraulic Oil, AW32 55 gallon drum
MIS-100D55-BIO	Hydraulic Oil, Bio, 55 gallon drum
MIS-100E5	Worm Gear Oil #7, 5 gallon pail



MIS-100D5



MIS-100E5



MIS-100D55



MIS-100D



MIS-100T

Oil Treatment

S.E.E.S. #	Description
MIS-100T	Hydraulic Oil Treatment, 1 Gallon



Valves



TBLV-020



GBLV020



GBLV030



PRV-2-GRV



PRV-2-NPT

Ball Valves

S.E.E.S. #	Description
TBLV-015	Threaded Ball Valve, 1-1/2"
TBLV-020	Threaded Ball Valve, 2"
TBLV-025	Threaded Ball Valve, 2-1/2"
TBLV-030	Threaded Ball Valve, 3"
TBLV-040	Threaded Ball Valve, 4"
GBLV020	Grooved Ball Valve, 2"
GBLV025	Grooved Ball Valve, 2-1/2"
GBLV030	Grooved Ball Valve, 3"
GBLV040	Grooved Ball Valve, 4"
HYD-MBV-020	Maxton Ball Valve, 2" Elevator Code Compliant
HYD-MBV-025	Maxton Ball Valve, 2-1/2" Elevator Code Compliant
HYD-MBV-030	Threaded Ball Valve, 3" Elevator Code Compliant

Rupture Valves

S.E.E.S. #	Description
PRV-2-GRV	Pipe Rupture Valve, 2", Grooved
PRV-2-NPT	Pipe Rupture Valve, 2", NPT
PRV-25-GRV	Pipe Rupture Valve, 2-1/2", Grooved
PRV-25-NPT	Pipe Rupture Valve, 2-1/2", NPT
PRV-3-GRV	Pipe Rupture Valve, 3", Grooved
PRV-3-NPT	Pipe Rupture Valve, 3", NPT

TKE Shut Off Valve

S.E.E.S. #	O.E.M. #	Description
TSOV-001	9884180	Muffler, 2" GRV to 2" GRV, 6-5/8" O.D., 11/3-4" long. / 185 GPM max.



TSOV-001

Hydraulic Ball Valves and Pipe Fittings

BY GRINNELL

Flexible couplings

Part Number	Description/Size Compare to Victaulic® 77
GRN-70715TS	Flexible coupling, 1-1/2 in.
GRN-70720TS	Flexible coupling, 2 in.
GRN-70725TS	Flexible coupling, 2-1/2 in.
GRN-70730TS	Flexible coupling, 3 in.
GRN-70740TS	Flexible coupling, 4 in.



Rigid couplings

Part Number	Description/Size Compare to Victaulic® HP-70
GRN-77020TS	Rigid coupling, 2 in.
GRN-77025TS	Rigid coupling, 2-1/2 in.
GRN-77030TS	Rigid coupling, 3 in.
GRN-77040TS	Rigid coupling, 4 in.



Concentric reducer

Part Number	Description/Size
GRN-72858	Concentric reducer, goes from 2.5 in. to 2 in.



Universal go/no-go gauge

Part Number	Description/Size
GRN-4044	Go/no-go gauge



Victaulic® is a registered trademark of the Victaulic Corporation. There is no relationship between the Victaulic Corporation and

Elbows and fittings

Part Number	Description/Size Compare to Victaulic® 10
GRN-21015S	90° elbow, 1-1/2 in.
GRN-21020S	90° elbow, 2 in.
GRN-21025S	90° elbow, 2-1/2 in.
GRN-21030S	90° elbow, 3 in.
GRN-21040S	90° elbow, 4 in.



Part Number	Description/Size Compare to Victaulic® 11
GRN-20120S	45° elbow, 2 in.
GRN-20125S	45° elbow, 2-1/2 in.
GRN-20130S	45° elbow, 3 in.
GRN-20140S	45° elbow, 4 in.



Part Number	Description/Size Compare to Victaulic® 12
GRN-31220S	22.5° elbow, 2 in.
GRN-31225S	22.5° elbow, 2-1/2 in.
GRN-31230S	22.5° elbow, 3 in.
GRN-31240S	22.5° elbow, 4 in.

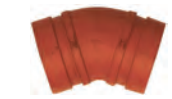

Part Number	Description/Size Compare to Victaulic® 13
GRN-31320S	11.25° elbow, 2 in.
GRN-31325S	11.25° elbow, 2-1/2 in.
GRN-31330S	11.25° elbow, 3 in.
GRN-31340S	11.25° elbow, 4 in.

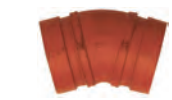

Part Number	Description/Size Compare to Victaulic® 20
GRN-21920S	Tee, 2 in.
GRN-21925S	Tee, 2-1/2 in.
GRN-21930S	Tee, 3 in.
GRN-21940S	Tee, 4 in.



Part Number	Description/Size Compare to Victaulic® 60
GRN-26020S	End cap, 2 in.
GRN-26025S	End cap, 2-1/2 in.
GRN-26030S	End cap, 3 in.
GRN-26040S	End cap, 4 in.



Part Number	Description/Size
MIS-173B	Nitrile gasket, 1-1/2 in.
MIS-173A	Nitrile gasket, 2 in.
MIS-173	Nitrile gasket, 2-1/2 in.
MIS-174	Nitrile gasket, 3 in.
GRN-40NITRILS	Nitrile gasket, 4 in.



Pipe



Pipe

S.E.E.S. #
Description
Victaulic to Victaulic

SEES-PIPE-2080-004-VV	Pipe, 2" Sch 80 4" L, victaulic to victaulic
SEES-PIPE-2080-006-VV	Pipe, 2" Sch 80 6" L, victaulic to victaulic
SEES-PIPE-2080-008-VV	Pipe, 2" Sch 80 8" L, victaulic to victaulic
SEES-PIPE-2080-010-VV	Pipe, 2" Sch 80 10" L, victaulic to victaulic
SEES-PIPE-2080-012-VV	Pipe, 2" Sch 80 12" L, victaulic to victaulic
SEES-PIPE-2080-024-VV	Pipe, 2" Sch 80 24" L, victaulic to victaulic
SEES-PIPE-2080-036-VV	Pipe, 2" Sch 80 36" L, victaulic to victaulic
SEES-PIPE-2080-048-VV	Pipe, 2" Sch 80 48" L, victaulic to victaulic
SEES-PIPE-2080-060-VV	Pipe, 2" Sch 80 60" L, victaulic to victaulic
SEES-PIPE-2080-10-VV	Pipe, 2" Sch 80 Vic-Vic Ends, 10' Length
SEES-PIPE-2080-240-VV	Pipe, 2" Sch 80 240" L, Vic-Vic 21' Length
SEES-PIPE-2080-21-VV	Pipe, 2" Sch 80 Vic-Vic Ends, 21' Length
SEES-PIPE-2580-016-VV	Pipe, 2-1/2" Sch80 Vic-Vic Ends, 16" Length
SEES-PIPE-2580-025-VV	Pipe, 2-1/2" Sch80 Vic-Vic Ends, 25" Length
SEES-PIPE-2580-031-VV	Pipe, 2-1/2" Sch80 Vic-Vic Ends, 31" Length
SEES-PIPE-2580-036-VV	Pipe, 2-1/2" Sch80 Vic-Vic Ends, 36" Length
SEES-PIPE-2580-042-VV	Pipe, 2-1/2" Sch80 Vic-Vic Ends, 42" Length
SEES-PIPE-2580-043-VV	Pipe, 2-1/2" Sch80 Vic-Vic Ends, 43" Length
SEES-PIPE-2580-048-VV	Pipe, 2-1/2" Sch80 Vic-Vic Ends, 48" Length
SEES-PIPE-2580-054-VV	Pipe, 2-1/2" Sch80 Vic-Vic Ends, 54" Length
SEES-PIPE-2580-104-VV	Pipe, 2-1/2" Sch80 Vic-Vic Ends, 104" Length
SEES-PIPE-2580-10-VV	Pipe, 2-1/2" Sch80 Vic-Vic Ends, 10' Length

Victaulic to Threaded

SEES-PIPE-2080-004-VT	Pipe, 2" Sch 80 4" L, victaulic to threaded
SEES-PIPE-2080-006-VT	Pipe, 2" Sch 80 6" L, victaulic to threaded
SEES-PIPE-2080-008-VT	Pipe, 2" Sch 80 8" L, victaulic to threaded
SEES-PIPE-2080-010-VT	Pipe, 2" Sch 80 10" L, victaulic to threaded
SEES-PIPE-2080-012-VT	Pipe, 2" Sch 80 12" L, victaulic to threaded
SEES-PIPE-2080-024-VT	Pipe, 2" Sch 80 24" L, victaulic to threaded
SEES-PIPE-2080-036-VT	Pipe, 2" Sch 80 36" L, victaulic to threaded
SEES-PIPE-2080-048-VT	Pipe, 2" Sch 80 48" L, victaulic to threaded
SEES-PIPE-2080-060-VT	Pipe, 2" Sch 80 60" L, victaulic to threaded

Threaded to Threaded

SEES-PIPE-2080-004-TT	Pipe, 2" Sch 80 4" L, threaded to threaded
SEES-PIPE-2080-006-TT	Pipe, 2" Sch 80 6" L, threaded to threaded
SEES-PIPE-2080-008-TT	Pipe, 2" Sch 80 8" L, threaded to threaded
SEES-PIPE-2080-010-TT	Pipe, 2" Sch 80 10" L, threaded to threaded
SEES-PIPE-2080-012-TT	Pipe, 2" Sch 80 12" L, threaded to threaded
SEES-PIPE-2080-024-TT	Pipe, 2" Sch 80 24" L, threaded to threaded
SEES-PIPE-2080-036-TT	Pipe, 2" Sch 80 36" L, threaded to threaded
SEES-PIPE-2080-048-TT	Pipe, 2" Sch 80 48" L, threaded to threaded
SEES-PIPE-2080-060-TT	Pipe, 2" Sch 80 60" L, threaded to threaded
SEES-PIPE-2080-10-TT	Pipe, 2" Sch 80 Thrd-Thrd Ends, 10' Length
SEES-PIPE-2080-21-TT	Pipe, 2" Sch 80 Thrd-Thrd Ends, 21' Length

Plain Ends

SEES-PIPE-2080-10	Pipe, 2" Sch 80 Plain Ends, 10' Length
SEES-PIPE-2080-21	Pipe, 2" Sch 80 Plain Ends, 21' Length

Custom Length

SEES-PIPE-2080-SPECIAL	Pipe, 2" Sch 80, Special Length
------------------------	---------------------------------

Ask about SEES custom threading and grooving.

Couplings

S.E.E.S. #	O.E.M. #	Description
SEES-HYD-FIT-300-01	69104	Elbow, 3/4" Black Pipe Class 300
SEES-HYD-FIT-300-02	69105	Elbow, 1" Black Pipe Class 300
SEES-HYD-FIT-300-03	69108	Elbow, 2" Black Pipe Class 300
SEES-HYD-FIT-300-04	69414	Coupling, 3/4" Black Pipe Class 300
SEES-HYD-FIT-300-05	69105	Coupling, 1" Black Pipe Class 300
SEES-HYD-FIT-300-06	69418	Coupling, 2" Black Pipe Class 300
SEES-HYD-FIT-300-07	69442	Reducer, 3/4" x 1", Black Pipe Class 300
SEES-HYD-FIT-300-08	69254	Tee, 3/4" Black Pipe Class 300
SEES-HYD-FIT-300-09	69255	Tee, 1" Black Pipe Class 300
SEES-HYD-FIT-300-10	69258	Tee, 2" Black Pipe Class 300
SEES-HYD-FIT-300-11	69604	Union, 3/4" Brass Seat Class 300
SEES-HYD-FIT-300-12	69605	Union, 1" Brass Seat Class 300
SEES-HYD-FIT-300-13	69608	Union, 2" Brass Seat Class 300

Clamps

S.E.E.S. #	O.E.M. #	Description
HYD-CLAMP-001	9702003	Clamp, Hose 2-3/8"
HYD-CLAMP-002	9702027	Clamp, Hose 3-1/2"
HYD-CLAMP-003	9701990	Clamp, Hose 1-7/8"
HYD-CLAMP-004	9702015	Clamp, Hose C 2-7/8" X 3-3/4"
HYD-CLAMP-005	9702404	Clamp, Hose 5-1/2"

Ask about SEES custom threading and grooving.

Accessories

Test Tags

S.E.E.S. #	Description
MIS-166AB	Data Tag, for Hydro Specs, 2-1/2" x 5" self-adhesive
MIS-166AG	Test Tag, 2" x 3.5" Alum Hydro Pressure Test
MIS-166HT	Test Tag, Hydro Elevator 4x6 A17.1-2007 & A171a-2008

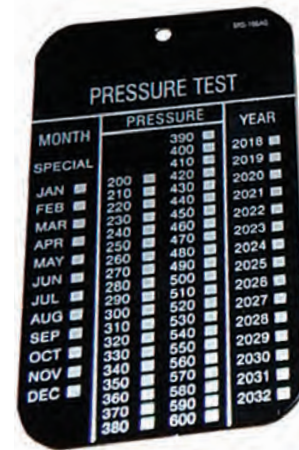

MIS-166AG

Hydraulic Elevator - Periodic Test Tag					
Person or Firm Performing Test:					
Periodic Test Category: 1					
A17.1-2007 & earlier Rqmt. #	A17.1a-2008 & later Rqmt. #	Test Item	Test Date	Test Date	Test Date
8.11.3.2.1	8.6.5.14.1	Relief Valve & System Pressure			
8.11.3.2.2	8.6.5.14.2	Cylinder & Pressure Piping			
8.11.3.2.3(a)	8.6.5.14.3(a)	Normal Terminal Stopping Device			
8.11.3.2.3(b)	8.6.5.14.3(b)	Governors			
8.11.3.2.3(c)	8.6.5.14.3(c)	Safeties			
8.11.3.2.3(d)	8.6.5.14.3(d)	Oil Buffers			
8.11.3.2.3(e)	8.6.5.14.3(e)	Emergency Operation FFS			
8.11.3.2.3(f)	8.6.5.14.3(f)	Standby Power Operation			
8.11.3.2.3(g)	8.6.5.14.3(g)	Power Operation of Doors			
8.11.3.2.3(h)	8.6.5.14.3(h)	Terminal Speed Reducing			
8.11.3.2.3(i)	8.6.5.14.3(i)	Low Oil Protection			
8.11.3.2.4	8.6.5.14.4	Flexible Hose & Fitting			
8.11.3.2.5	8.6.5.14.5	Pressure Switch			
	8.6.5.14.6	A17.1-2010 - Power Operation of Door System			
	8.6.5.14.7	A17.1-2010 - Slack-Rope Device			

MIS-166HT

Accessories



HYD-OL-001



HYD-OL-002



HYD-PSW-001



HYD-PSW-002



HYD-PSW-003



HYD-CONTROLLER-001R



MIS-TOOL-150

Oil Level

S.E.E.S. #	Description
HYD-OL-001	Oil Level, Low Oil Level Switch
HYD-OL-002	Oil Level, Sight Gauge with Thermometer
HYD-OL-003	Low Oil Level Float Switch, with Mounting Brkt
HYD-OL-004	Low Oil Float Switch, EECO

Pressure Switches

S.E.E.S. #	Description
HYD-PSW-001	Pressure Switch, High & Low 45-900 PSI range
HYD-PSW-002	Pressure Switch, Low Pressure 15-150 PSI Range, 250V Max.
HYD-PSW-003	Pressure Switch, 25 TO 500 PSI, Adjustable Range, 1000 Max, 1/2 NPT

Load Weigh Switches

S.E.E.S. #	Description
HYD-LWS-001	Load Weigh Switches, 130-500 PSI Range
HYD-LWS-002	Load Weigh Switches, 250-600 PSI Range



HYD-LWS-001

Vertitron Hydraulic Controller

S.E.E.S. #	Description
HYD-CONTROLLER-001R	Controller, VHC-102 with Reflex Selector
HYD-CONTROLLER-002	Controller, Basic Hydro Controller less Soft Start
HYD-CONTROLLER-002M	Magnets, For -002 Controller
HYD-CONTROLLER-002-SELECTOR	Selector Assembly, For -002 Controller, Tapeless

Battery Lowering Device

S.E.E.S. #	Description
HYD-E-LOWER-001	Battery Lowering Device



SEES-TOOL-001

Tools

S.E.E.S. #	Description
SEES-TOOL-001	Valve Shut-Off Lever, Dover, 12" Long
MIS-TOOL-150	Dynamometer / Scale, 5,000 lbs. 5" diameter face with case
MIS-TOOL-200	Transfer Pump, 115V, 5/8", Ports, 300 GPH
MIS-TOOL-201	Ports Utility Pump, 1/2HP, 3/4", 115V, 100 psi

Accessories

S.E.E.S. #	Description
HYD-ADAPTER-KIT	Adaptor, Right Hand Jack Port
HYD-BV-001	Ball Valve, 1/8" NPT MxM for Pressure Switch
HYD-BV-002	Ball Valve, 1/4" NPT female to male
HYD-MV-2ADAPT	Adaptor, 2" Grooved x 2" Threaded
HYD-ISOLATION-PADS	Under Tank Isolation Pads, with hardware
HYD-ISOLATION-MOUNTS	Hydro Motor Mount Bushing, Dual Stud 3/8-16
SEES-ISOP-001	SEES Isolation Pad, 6" x 2" Urethane/UHMW, 1-3/4" OAH
SEES-ISOP-002	SEES Isolation Pad, 1-1/2" SQ x 1/8" Neoprene Pad, 1/2" Hole, Set of 4
HYD-MBV-020	Maxon Ball Valve, 2" Elev Code Compliant
HYD-MBV-025	Maxon Ball Valve, 2-1/2" Elev Code Compliant
HYD-MBV-030	Maxon Ball Valve, 3" Elev Code Compliant



HYD-BV-001



HYD-ADAPTER-KIT



SEES-ISOP-002



HYD-BV-002



HYD-ISOLATION-PADS



SEES-ISOP-001



HYD-ISO-002



HYD-ISO-004

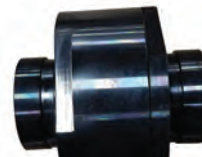

HYD-ISO-001



TIG-001



TIG-002

Isolation Couplings

S.E.E.S. #	Description
HYD-ISO-001	Isolation Coupling, 2" Grooved
HYD-ISO-002	Isolation Coupling, 2" Threaded
HYD-ISO-003	Isolation Coupling, 2-1/2" Grooved
HYD-ISO-004	Isolation Coupling, 3" Grooved

Isolation Gaskets

S.E.E.S. #	O.E.M. #	Description
TIG-001	9714303	Thyssenkrupp Isolation Gasket, 3" Sound Iso Coupling Gasket
TIG-002	9723213	Thyssenkrupp Isolation Gasket Insert, for P-145 Coupling 3.75" x 5"
TIG-003	9712665	Thyssenkrupp Isolation Gasket, Sound Coupling 2"



TIG-003

Oil Viewing Device

S.E.E.S. #	Description
HYD-OVD-001	Maxview, Oil Viewing Device
HYD-OVD-002	Safetach, Elevator Performance Meter with Remote
HYD-OVD-003	Safetach 2, Elevator Performance Meter with Remote



HYD-OVD-001



HYD-OVD-002



HYD-OVD-003



Hydraulic Filtration and Cooling Systems

S.E.E.S. # MIS-FLT-001

Specifications:

- 3/4 HP
- 10 GPM Pump
- 6 Micron Rated Filter
- Sump Strainer
- 9' Electric Cable
- 8" Hoses
- 10" Pneumatic Tires



MIS-FLT-008



MIS-FLT-009



MIS-FLT-010



MIS-FLT-017



MIS-FLT-012



MIS-FLT-R1



MIS-FLT-R2



MIS-FLT-R3



MIS-OIL-COOLER-001

S.E.E.S. #	Description
MIS-FLT-001	Portable Filter Cart
MIS-FLT-001P	Oil Cart Pump, Replacement
MIS-FLT-002M	Kidney Loop Filtration System with mounting Kit
MIS-FLT-007	Breather, Desiccant and Activated Carbon Moisture and Odor Control
MIS-FLT-007A	Breather, Activated Carbon - Odor Control
MIS-FLT-008	Breather, Adapter
MIS-FLT-009	Gasket Material
MIS-FLT-010	Pressure Gauge, 2-1/2" Face, 0-600 PSI
MIS-FLT-012	Suction Strainer, 3/4" NPT
MIS-FLT-013	Ball Valve, Low Pressure 1-1/2" Full Flow
MIS-FLT-017	Filtration Bag
MIS-FLT-IM284	Motor Generator Filter, 284A, 2 Cubes, 2 Panels
MIS-FLT-R1	Replacement Element Cartridge, Particle Removal, for EconoGreen Trans cart
MIS-FLT-R2	Replacement Element Cartridge, Water Removal, for filter cart
MIS-FLT-R3	Particulate Removal Element, for MIS-FLT-001
MIS-FLT-WH5014A	Filter set frame 5014A 4 Panels
MIS-OIL-COOLER-001	Oil Cooler, hydraulic heat exchanger, 26,100 BTU/Hr SinglePhase, 115/230V with hose, remote mount air to oil with Hydro motor and thermostat control
MIS-OIL-COOLER-003	Tank Cooler, direct mount over top of tank, requires no plumbing, 2,000 BTU/Hr, 36" x 14" x 8" auto start at 120° F
MIS-OIL-COOLER-FAN	Fan, Cooler AOC Series
MIS-OIL-COOLER-PUMP	Pump, Oil Cooler, Used on MEI's AOC and BOL

Pressure Gauges

S.E.E.S. #	O.E.M. #	Description
MIS-211B	SE72142.5.25-1K	Gauge Kit, 0-1K PSI, with 1/4" NPT center back mounting



MIS-211B

SEES Pressure Gauges and Adaptors

S.E.E.S. #	Description
SEES-HYD-PG	SEES Pressure Gauge, 1K PSI, for tanks, with ball valve
SEES-HYD-PG-001	Pressure Gauge Elbow Adaptor, for Thyssen, fits 1/8" NPT x 1.26" OAL
SEES-HYD-PG-002	Pressure Gauge Elbow Adaptor, for Otis, fits 1/4" NPT x 1.52" OAL
SEES-HYD-PG-003	Pressure Gauge Elbow Adaptor, for Kone, fits 3/8" NPT x 1.76" OAL
SEES-HYD-PG-004	Pressure Gauge Elbow Adaptor, fits 1/4" NPT x 1.81" OAL
SEES-HYD-PG-005	SEES Pressure Gauge Adaptor Kit, for Thyssen, Otis, Kone and other
SEES-HYD-PG-006	SEES Pressure Gauge & Hose, 1K PSI, with quick connect
SEES-HYD-PG-007	SEES Pressure Gauge Kit, all adaptors, pressure gauge and hose
SEES-HYD-PG-008	Hose Only, 3 ft with 1/4" FNPT x 1/8" MNPT
SEES-HYD-PG-009	Quick Disconnect, Female, 1/2-14 ISO 7241-1 Series B
SEES-HYD-PGP	SEES Pressure Gauge Port, quick release only
SEES-HYD-PGPF	SEES Hydro Pressure Gauge Port, Female quick release with 90 deg 1/8 elbow



SEES-HYD-PG



SEES-HYD-PG-001



SEES-HYD-PG-002



SEES-HYD-PG-003



SEES-HYD-PG-004



SEES-HYD-PG-005



SEES-HYD-PG-006



SEES-HYD-PG-007



SEES-HYD-PG-008



SEES-HYD-PGP



Jack Packing

Designed for dependable service, easily installed. Highest quality materials provide uniform pressure for a complete seal with no pressure points or uneven wear. Smoother ride plus longer life equals superior sealing.



PAC-44



PAC-1

S.E.E.S. #	O.E.M. #	Seal Dimensions
PAC-1	3E006	3-1/2" x 4-1/2"
PAC-1A	6E021	3-7/8" x 4-7/8"
PAC-1B	3E023	3.96" x 4.96"
PAC-1C	00-00-F02832-LF000	2.832" x 2.811"
PAC-2	3E031	4" x 5"
PAC-3	3E007	4-3/8" x 5-3/8"
PAC-4	3E017	4-7/16" x 5-7/16"
PAC-5	3E029	4-1/2" x 5-1/2"
PAC-5A	6E022 Series 600-50	4-7/8" x 5-7/8"
PAC-6	3E004	5" x 6"
PAC-45	3E010 D Series 300-F	5-1/4" x 6-1/4"
PAC-6A	6E047 Series 600-50	5-3/8" x 6-3/8"

S.E.E.S. #	O.E.M. #	Seal Dimensions
PAC-7	3E019 Series 300-F	5-7/16" x 6-7/16"
PAC-8	3E022 Series 300-F	5-1/2" x 6-1/2"
PAC-8A	6E1715FSS Super Slick	5-1/2" x 6-1/2"
PAC-10	3E020	6" x 7"
PAC-11	3E009	6-1/2" x 7-1/2"
PAC-12	3E008	7" x 8"
PAC-13	3E045 Series 300-F	7-1/2" x 8-1/2"
PAC-14	3E043, 6E030	8-1/2" x 9-1/2"
PAC-15	3E055	9-1/2" x 10-1/2"
PAC-44	1A084-10 Auto Pak	3-7/8" x 4-7/8 x 3/4"
PAC-48	1A084-01 Auto Pak	4-3/8" x 5-3/8 x 2-1/2"
PAC-PFLEX-001	6EA149-02	Telescopic Jack Seals, 3 Stage, Porta Flex

Jack Packing for Dover

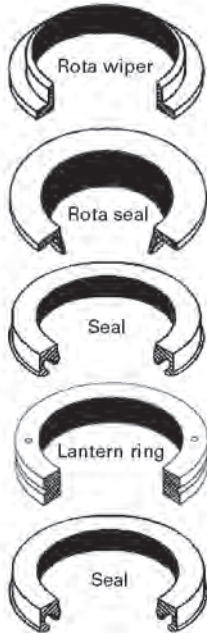

S.E.E.S. #	O.E.M. #	Description	Plunger Size
PAC-44	1A084-10, 9832907	Autopak for IVO-3S (includes "O" ring)	3-7/8"
DPAC-20	3EA023-01	Packing, Rotary Lift (2 Seals, Lantern Ring)	4-3/8"
DPAC-20A	3EA024-04	Packing Set (2 Seals, Lantern Ring)	4-1/2"
DPAC-21	3EA023-02	Packing, Rotary Lift (2 Seals, Lantern Ring)	5-7/16"
DPAC-22	3EA023-03	Packing, Rotary Lift (2 Seals, Lantern Ring)	6-1/2"
DPAC-22A	3EA023-11, 9787239, 9870349	Packing, 3S, (Rota Seal & Wiper)	3-1/2"
DPAC-22B	9844600	Jack Seal Kit, 3T	
DPAC-22C	9851094	Packing, 3S, (Rota Seal & Wiper)	
DPAC-22D	9844612	Jack Seal Kit, 2.5T	
DPAC-23	3EA023-12, 9787240, 9705272	Packing, 4S, (Rota Seal & Wiper)	4-3/8"
DPAC-23A	4E003, 9787240, 9708467	Packing, 4S (Rota Seal Only)	4-3/8"
DPAC-24	3EA023-13, 9787252, 9705442	Packing, 5S, (Rota Seal & Wiper)	5-7/16"
DPAC-24A	4E004, 9787252	Packing, 5S, (Rota Seal Only)	5-7/16"
DPAC-24B	9851010	Jack Packing Parker, 5S	
DPAC-25	3EA023-14, 9787264, 9705612	Packing, 6S, (Rota Seal & Wiper)	6-1/2"
DPAC-25A	4E005, 9787264, 9708480	Packing, 6S, (Rota Seal Only)	6-1/2"
DPAC-25C	9743066	Packing, 7S, (Rota Seal & Wiper)	7-1/2"
DPAC-25D	10-72-R06500-LF10Z	Dover S Head	6-1/2"
DPAC-26	06-00FO3000	Packing Set, holeless LF2 OZ packing set	3" (1 jack)

Dover Seals

S.E.E.S. #	O.E.M. #	Description
DPAC-27	9873200	Seal, Oil Output GD1
DPAC-28	9873223	Seal, Oil Worm with Carrier
DPAC-28A	9873223	Seal, Oil Worm
DPAC-31C	9824479	Pedestal side seal, for GD-240, GD-200, 4.88" x 6.25" x .5"
DPAC-31D	9824467	Strainer Assembly, Valve 1-2
DPAC-34	9825538	Oil Seal, for GD 45, GD 105
DPAC-35	9740053	Adapter Seal, 10.125" for GD 105
SEES-TOOL-001		Dover Valve Shut-Off Lever, 12" Long

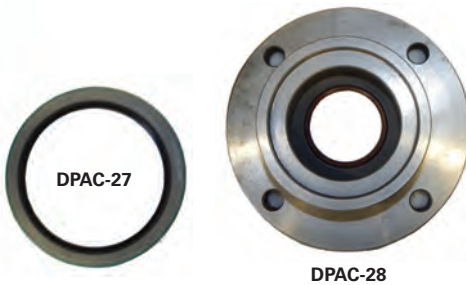

Jack Packing for Schindler / Westinghouse

S.E.E.S. #	O.E.M. #	Jack Size
WPAC-16	691B864H02, 196C145H05, 6E003	4-1/2"
WPAC-18A	196C145H08	6"
WPAC-19	691B864H05, 7264C45H08, 6E024	6-1/2"

S.E.E.S. #	O.E.M. #	Description
SPAC-001	7260X18H20	Seal Kit, 321A/330A, 75-2N Jack
SPAC-002	7260C18H23	Seal Kit, 321A/330A, 75-3S Jack
SMK-002	TD329G01	Gemini Jack Seal Replacement Kit

S.E.E.S. #	Description
PAC-47	Round Rod Packing, 9/16" diameter. Flexible rubber hollow cord, cut to your specified length



Jack Packing for Thyssenkrupp

S.E.E.S. #	O.E.M. #	Jack Size
TPAC-23B		4S 4-3/8"
TPAC-25	10-72-F06500-LF10Z	6S After 2001

Otis Seals & Packing

S.E.E.S. #	O.E.M. #	Description
OPAC-001	AAA182AN1	Packing Kit, 2-7/8", Otis Holeless, Mfg Prior to 2000
OPAC-002	AAA182AN2	Packing Kit, 3-15/16", Otis Holeless, Roped, Mfg After 2000
OPAC-003	AAA182AN11	Packing Kit, 4-7/16", Otis Holeless, Roped, Mfg After 2000
OPAC-004	AAA172SV1	Wiper Ring
OPAC-005	AAA182AN9	Packing Set, 6-1/2" Diameter, Plunger for Welded Head Cylinder
OPAC-006	AAA182AN12	Packing Set, 5-1/2" Otis Holeless Roped, Mfg After 2000
OPAC-007	AAA182AN3	Packing Set, 3-15/16" Otis Welded Head, Mfg After 1991

Schindler Seal Kits

S.E.E.S. #	O.E.M. #	Description
SPAC-001	7260X18H20	Seal Kit, 321A/330A, 75-2N Jack
SPAC-002	7260C18H23	Seal Kit, 321A/330A, 75-3S Jack

Gorman Packing Kits

Schindler / Gemini

S.E.E.S. #	Description
00-00-MM0060.5-075.5	Packing Kit, 2.365" Jack Packing Schindler Gemini Telescopic
18-42-MM60.5-075.5	Packing Kit, 2.365" Schindler Gemini Telescopic
18-42-MM0750-09000	Packing Kit, 2.953" Schindler Gemini Telescopic
18-42-MM0900-10500	Packing Kit, Gemini, 90mm x 105mm
18-42-MM0105-12000	Victaulic Packing Kit, Gemini, 105mm x 120mm
18-42-B07000-GW000	Packing Kit, 7" Schindler MPH2 After 1989

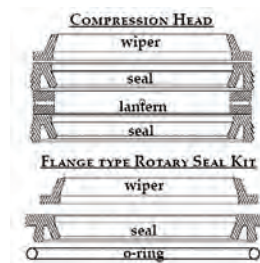

01-10-F08500-E0000



Dover

S.E.E.S. #	Description
17-18-T3000-LF2Z3	Packing Kit , Dover telescopic 3" & 4-1/4" type 3.0T kit
06-00-F03000-LF20Z	Packing Set , Dover 3" dual post holeless (1 piston kit)
01-10-F08500-E0000	Packing Kit , Dover "S" Head Compression, 8-1/2"
10-72-R05437-LF10Z	Packing Kit , Dover "S" Head 5-7/16" Seal Kit with Bearing Manf. 1933 ro 2002 -5S
10-72-R04375-LF10Z	Packing Kit , Dover "S" Head 4-3/8" Seal Kit with Bearing Manf. 1933 ro 2002 -4S
17-18-T30000-LF2Z4	Packing Kit , Dover 3.0T Telescopic

Montgomery

S.E.E.S. #	Description
12-00-F03000-LF200	Packing Kit , Montgomery Holeless, 3"
12-00-F03500-LF200	Packing Kit , Montgomery Holeless 3.5"
01-38-F04375-LF100	Packing Kit , Montgomery, 4-3/8"
17-38-F05500-LF100	Packing Kit , 5-1/2" Montgomery

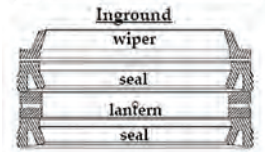
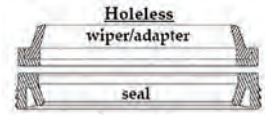

12-00-F03500-LF200

ESCO

S.E.E.S. #	Description
01-45-04500-00000	Packing Kit , ESCO P4&P5 Head, 4-1/2"
01-45-06000-00000	Packing Kit , ESCO P4&P5 Head, 6"
01-45-06500-00000	Packing Kit , ESCO P4&P5 Head, 6-1/2"
07-05-F05000-LF100	Packing Kit , ESCO P6 Victaulic, 5"
07-05-F06000-LF100	Packing Kit , ESCO P6 Victaulic, 6"
07-05-F07000-LF100	Packing Kit , ESCO P6 Victaulic, 7"

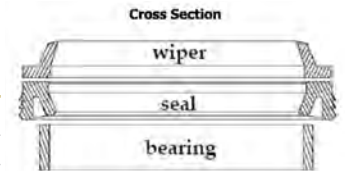

07-05-F07000-LF100

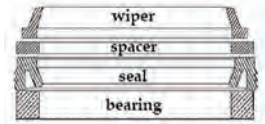

12-04-F02840-LF1S0

Otis

S.E.E.S. #	Description
12-04-F02750-LF100	Packing Kit , Otis Holeless, 2-3/4"
12-04-F02840-LF1S0	Packing Kit , Otis Holeless, 2.84"
14-32-EE5500-LF200*	Packing Kit , Otis Welded Head, 5-1/2"
01-46-F04375-E0000	Packing Kit , Otis Cast Iron, 4-3/8"
01-46-F05437-E0000	Packing Kit , Otis Cast Iron, 5-7/16"
01-46-F06500-E0000	Packing Kit , Otis Cast Iron, 6-1/2"
01-46-H08500-E0000	Packing Kit , Otis Cast Iron 8-1/2"
14-04-EE4438-LF200	Packing Kit , Otis Holeless/Roped 3-15/16", Mfg After 2000
14-04-EE3938-LF200	Packing Kit , Otis Holeless/Roped 3-15/16", Mfg After 2000
14-04-EE3938-LF200	Packing Kit , Otis Holeless/Roped 4-7/16", Mfg After 2000
14-04-EE4438-LF200	Packing Kit , Otis Holeless/Roped 4-7/16", Mfg After 2000
14-32-F05000-LF100	Packing Kit , Otis Welded Head 5", Mfg. after 1991

Haugton

S.E.E.S. #	Description
52-F02750-180-RO	Seal Kit, Haugton 2-3/4" x 3-3/4"
50-F02750-ER	Seal Kit, Haugton 2-3/4" x 3-3/4"

General

S.E.E.S. #	Description
02-19-F03437-E0000	Packing Set, General Alum Head 3-7/16"
02-19-F04437-E0000	Packing Kit, General Alum HD, 4-7/16"
02-19-F05437-E0000	Packing Kit, General Alum HD, 5-7/16"
02-19-F06437-E0000	Packing Kit, General Alum HD, 6-7/16"
02-19-F07500-E0000	Packing Kit, General Alum HD, 7-1/2"
05-21-F04000-E0000	Packing Kit, General "G" Head, 4"
05-21-F05000-E0000	Packing Kit, General "G" Head, 5"
06-21-F05500-E0000	Packing Kit, General "G" Head, 5-1/2"
05-30-F04500-E0000	Packing Kit, General F2 Head, 4-1/2"
06-29-F04437-E0000	Packing Kit, General F2 Head 4-7/16" Packing Kit
06-30-F05500-E0000	Packing Kit, General F2 Head, 5-1/2"

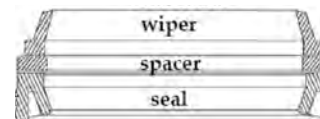

06-29-F04437-E0000

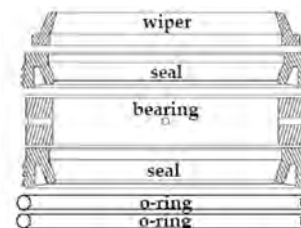

00-12-DC2750-0000

EECO

S.E.E.S. #	Description
00-39-F06500-L10Z	Packing Set, EECO PJ7, 6-1/6"
03-39-F08000-LF10Z	Packing Kit, EECO PJ, Standard, 8"
00-12-DC2750-0000	Packing Set, EECO NJ, Holeless Seal Set Piston Size - 2-3/4"
00-39-F06500-LF10Z	Packing Set, EECO PJ7 6-1/6" packing kit
02-39-DC2750-0000Z	Packing Kit, EECO PJ 2-3/4", Standard
03-33-F04375-LF1ZZ	Packing Kit, EECO LJ&FJ, 4-3/8", Standard
03-33-F05000-LF1ZZ	Packing Kit, EECO LJ&FJ 5", Standard
03-33-F05437-LF1ZZ	Packing Kit, EECO LJ&FJ 5-7/16", Standard
03-33-F06000-LF1ZZ	Packing Kit, EECO LJ&FJ 6", Standard
03-33-F06500-LF1ZZ	Packing Kit, EECO LJ&FJ 6-1/2", Standard
03-39-F03437-LF10Z	Packing Kit, EECO PJ 3-7/16", Standard
03-39-F03875-LF10Z	Packing Kit, EECO PJ 3-7/8", Standard
03-39-F04375-LF10Z	Packing Kit, EECO PJ 4-3/8", Standard
03-39-F05000-LF10Z	Packing Kit, EECO PJ 5", Standard
03-39-F05437-LF10Z	Packing Kit, EECO PJ 5-7/16", Standard
03-39-F05500-LF10Z	Packing Kit, EECO PJ 5-1/2", Standard
EE-CO-TJ-250-KIT001	EECO Telescopic Kit

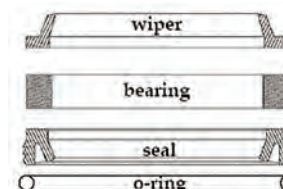

03-39-F05000-LF10Z

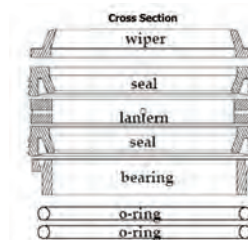

03-63-F04250-LF1ZZ

Armor

S.E.E.S. #	Description
52-F01500-180R	Oil Split Seal for Armor #1 Machine
09-65-F06562-E000Z	Packing Kit, Armor 6-9/16"



Mowrey

S.E.E.S. #	Description
03-63-F04250-LF1ZZ	Packing Set , Mowrey 4-1/4" Packing Kit
03-63-F04375-LF1ZZ	Packing Kit , Mowrey Standard, 4-3/8"
03-63-F04500-LF1ZZ	Packing Kit , Mowrey Standard, 4-1/2"
03-63-F05000-LF1ZZ	Packing Kit , Mowrey Standard, 5"
03-63-F05250-LF1ZZ	Packing Kit , Mowrey Standard, 5-1/4"
03-63-F05375-LF1ZZ	Packing Kit , Mowrey Standard, 5-3/8"
03-63-F05500-LF1ZZ	Packing Kit , Mowrey Standard, 5-1/2"
03-63-F06000-LF1ZZ	Packing Kit , Mowrey Standard, 6"
03-63-F06500-LF1ZZ	Packing Kit , Mowrey Standard, 6-1/2"

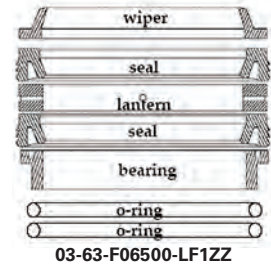

Southeastern

S.E.E.S. #	Description
04-07-F04375-E0000	Packing Kit , Southeastern, 4-3/8"
14-07-F04375-E0000	Packing Kit , Southeastern, 4-3/8"
14-07-F05500-E0000	Packing Kit , Southeastern, 5-1/2"
14-07-F06500-E0000	Packing Kit , Southeastern, 6-1/2"

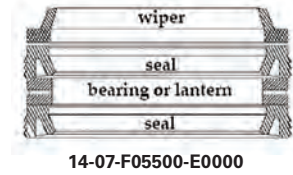

Miscellaneous

S.E.E.S. #	Description
01-01-F03000-E000Z	ASPB International , 3" Packing Kit
01-10-F09500-E0000	Packing Kit , Universal 9-1/2"
01-31-F05500-E0000	Packing Kit , Amtech Reliable 5.5"
50-G03125-180R	Packing Set , Seal #38 machine 3.125" x 4.250" x .500"
14-00-E03500-LF1XZ	Packing Set , United Holeless 3-1/2", Before Oct. 2000
18-42-B03750-GW000	Packing Kit , 3-3/4" Seal Kit without O-Rings
17-38-F03937-LF100*	Packing Kit , Jack Packing, 3-15/16"
17-12-F04000-LF1	Packing Kit , ITI, 4"
17-00-DC2000-0000	Packing Kit , ITI Hydraulic Telescopic & Holeless
14-41-F04500-LF1Z4	Packing Kit , 4-1/2" Seal Kit with O Rings and Teflon Braid
14-12-F05562-LF1Z3	Packing Kit , 5.526"
14-12-F06625-E00Z5	Packing Kit , United 6-5/8"
23-00-MM0900-1050Z	Packing Kit , 90mm x 105mm Model BZH/BZG Kit, Includes Wiper, Seal and O-Ring
24-86-DC2750-0000	Packing Kit , Custom Elevator, 2-3/4"

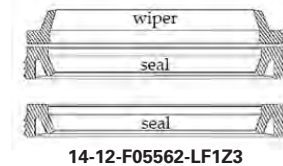
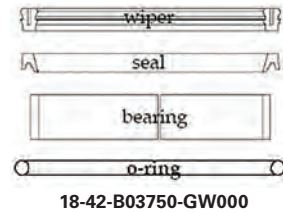

Canton

S.E.E.S. #	Description
14-00-F03000-E000	Packing Kit , Canton elevator packing kit 3"
14-00-F3000-LF20Z	Packing Kit , Canton, 3"
14-00-F03500-LF20Z	Packing Kit , Canton, 3-1/2"
14-00-F03500-E000Z	Packing Kit , Canton, 3-1/2"
14-00-F04000-E000Z	Packing Kit , Canton, 4"
14-00-F04500-E000Z	Packing Kit , Canton, 4-1/2"
14-00-F05000-E000Z	Packing Kit , Canton, 5"
14-00-F05500-E000Z	Packing Kit , Canton, 5-1/2"
14-00-F06000-E000Z	Packing Kit , Canton, 6"
14-00-F06500-E000Z	Packing Kit , Canton, 6-1/2"

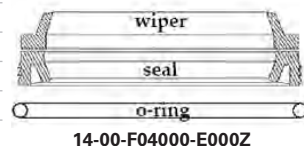
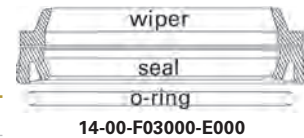

Cemcolift

S.E.E.S. #	Description
08-80-DC3937-0000Z	Packing Set , CEMCOLIFT, 3.9375" Size Holeless Roped
08-80-F04500-LF20Z	Packing Kit , Cemcolift, Holeless/Roped 4-1/2"
08-80-DC4730-0000Z	Packing Kit , Cemcolift, 4.730" Piston Size Holeless Roped
18-16-F06500-E00ZZ	Packing Kit , Cemcolift, In Ground, 6.5" Kit
18-16-F05500-E00ZZ	Packing Kit , Cemcolift, In Ground, 5.5" Kit
08-80-F07000-LF10Z	Packing Kit , Cemcolift, Holeless/Roped 7"
08-80-F03437-LF10Z	Packing Kit , Cemcolift, 3-7/16" Kit, w/ bearings and O Rings

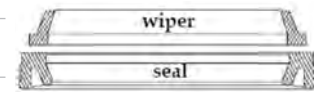

08-80-DC3937-0000Z

GMV

S.E.E.S. #	Description
13-69-MM0060-0800Z	Packing Set , GMV 60mm x 80mm Kit, 2.362" x 3.15"
13-69-MM0063-0830Z	Packing Kit , GMV 63mm x 83mm Kit
13-69-MM0070-0900Z	Packing Kit , GMV 70mm x 90mm Kit
13-69-MM0100-1200Z	Packing Kit , GMV 100mm x 120mm Kit, 3.937"

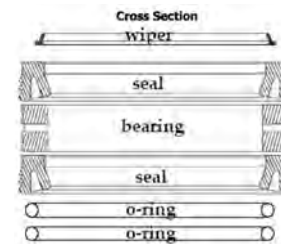

17-47-F05000-E00ZZ

Westinghouse

S.E.E.S. #	Description
17-47-F05000-E00ZZ	Packing Kit , Westinghouse, 5" w/ bearings and O rings
17-47-F08000-E00ZZ	Packing Kit , Westinghouse, F1 MPH1, 8"

Kone

S.E.E.S. #	Description
17-38-F06562-LF100	Packing Kit , 6-9/16" Kone/Montgomery
00-00-F08562-E0000	Seal , Kone, 8-9/16"
01-10-F08562-E0000	Packing Kit , Kone, 8-9/16"



Packing for U.S.

S.E.E.S. #	O.E.M. #	Description
USPAC-26	437-00010-000	Packing Set, 4-1/2" x 5 1/2"
USPAC-27	437-00011-000	Packing Set, 5" x 6" x 1-1/2" Split
USPAC-27A	437-00023-000	Packing Set, 5-1/2" x 6-1/2" Split, Autopak
USPAC-28	437-00012-000	Packing Set, 6" x 7" x 1/2" Soft Split, Autopak
USPAC-29	437-00025-000	Packing Set, 7" x 8" x 1-1/2"

Packing Tools

S.E.E.S. #	Description
PAC-43	Packing Replacement Kit – Everything you'll need to efficiently replace the packing in any hydraulic elevator or traction machine. This specialty tool kit contains: (2) #2 flexible Packing Hooks for removal of hydraulic packing; (2) #1 flexible Packing Hooks for removal of worm shaft packing; (2) Wooden dowels for installation of packing; (1) Diameter-reading tape for measuring the dia. of pistons or shafts; (1) Air valve to install into bleeder valve hole to relieve pressure of hydraulic packing; (2) Long handled screws to remove phenolic bearings or lantern rings
MIS-165	Measuring Tape , diameter-reading tape for measuring the diameter of pistons or shafts. One side measures in inches, the other side, inches of diameter by 64ths. (Also included in above tool kit)
PAC-47	Round Rod Packing , 9/16" diameter. Flexible rubber hollow cord, cut to your specified length



Packing for Porta Flex

S.E.E.S. #	Description
PAC-PFLEX-001	Teloscopic Jack Seals , 3 Stage, Porta Flex

Valve Gaskets

S.E.E.S. #	O.E.M. #	Description
CVP-001	RV-1208	Cemco Valve Gasket, Ring

Victaulic Seals

S.E.E.S. #	Description
MIS-173	Victaulic Seal, 2-1/2", Grade T
MIS-173A	Victaulic Seal, 2", Grade T
MIS-173B	Victaulic Seal, 1-1/2" Grade T1
MIS-174	Victaulic Seal, 3", Grade T
MIS-174A	Victaulic Seal, 3-1/2", Grade T
MIS-174V	Victaulic Seal, 3", Grade T



MIS-165



CVP-001



MIS-173A



MIS-174A

Seals

Worm Gear Seals

Designed for dependable service with ease of installation.
Heat and oil resistant material provides positive sealing performance.



S.E.E.S. #	O.E.M. #	Armor Worm Gear Seals	Seal Dimensions
PAC-46	R0175, 9668, 12331-01	Seal, Oil Split for #2 & #2BB	1-3/4" x 2-3/4" x .828"
PAC-46A	12080-02, 1R012	Seal, Oil Split for #3 Machine	1-15/16" x 2-7/8" x 1.266"
PAC-46B	R0200-03625, 12081-01	Seal, Oil Split for #4 & #4BB	2-1/8" x 3-1/8" x .438"
PAC-46C	12332-01	Seal, Oil Split for #5 & #5BB	3" x 4" x .500"
PAC-46D	12611-01	Seal, Oil Split for #7 Machine	4" x 5" x .438"

PAC-46A

S.E.E.S. #	O.E.M. #	Dover Worm Gear Seals	Seal Dimensions
DPAC-30A	1R043, 9763326, 76332 9752110, 75211	Worm Gear Seal , Split, w/ Deflector, machine # GD-45, GD-50, GD-75	1.749" x 2.650" x .500"
DPAC-31	1R002, 9825514 9752122, 26586	Worm Bearing Seals , Split w/ Deflector for GD-105, GD-200 and GD-240	2.345" x 3.220" x .500"
DPAC-32	9779231, 77924	Worm Seal , Gland packing, for GD-300	3" x 4" x .500"
DPAC-31A	1R048	Worm Gear Seal , Split (Inner), for 1R048	4.5" x 5.5" x .625"
DPAC-21A	5E006, 9767897, 76789, 9808644, 108644	Spider Seal , (Split), for GD-45	5-1/8" x 7" x 1/2"
DPAC-21B	9767894	Pedestal Shaft Seal for GD-45	5-1/8" x 7" x 1/2"
DPAC-25B	5E004, 9825526, 112733	Spider Seal , (Split) for GD-105	7-1/8" x 8-5/8" x 1/2"
DPAC-31B	5E005, 9824479, 72447 9722701, 72270, 9808760, 108763, 108763	Spider Seal , (Split) for GD-50, GD-75, GD-200, GD-240 and GD-300	8-1/2" x 10-1/4" x 1/2"
DPAC-33	9840503	Worm seal , for GDF-25	2" x 4.5" (flange) x .75"

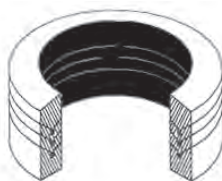

Worm Shaft
Packing for Otis



Split Seal

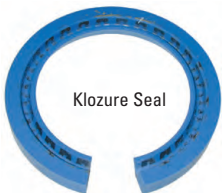

Klozure Seal



PAC-46

S.E.E.S. #	O.E.M. #	Otis Worm Gear Seals	Seal Dimensions
PAC-38	182A4	Packing Worm Shaft	1 - 7/8" x 3-1/8" x 2-1/16"
PAC-38A	182A3	Packing Worm Shaft	1 - 9/16" x 2-9/16" x 1-11/16"
PAC-38B	182A5	Packing Worm Shaft	2 - 1/8" x 3-3/8" x 2-5/8"
PAC-38C	182A6	Packing Worm Shaft	2 - 1/4" x 3-1/2" x 2"
PAC-38D	182A14	Packing Worm Shaft	1 - 7/16" x 2-7/16" x 1"
PAC-38F	182A17	Packing Worm Shaft	1 - 7/8" x 3-1/8" x 3-1/8"
PAC-38G	182A18	Packing Worm Shaft	1 - 7/8" x 3" x 2-5/8"
PAC-38H	182A19	Packing Worm Shaft	2 - 1/2" x 3-3/4" x 1-7/16"
OWPAC-32	33D26, 1R019-06	Worm Gear Seal, Split	3" x 4-1/2"
OWPAC-33	1R020-6	Worm Gear Seal, Split	2" x 3"
OWPAC-34	9726834	Locking Tab Washer	1" I.D.

S.E.E.S. #	O.E.M. #	I.D.	O.D.	Thick	Application
WPAC-36C	X30ES1H12	2-9/16"	3-3/4"	3/8"	#18 Gear
WPAC-36D	X30ES1H13	1-3/4"	3-3/16"	1/2"	#18 Worm
WPAC-36B	X30ES1H15	3-11/16"	4-3/4"	1/2"	#28 Gear
WPAC-39A	X30ES1H19	2-1/2"	3-1/2"	7/16"	#28 Worm
WPAC-35B	X30ES1H16	4"	5"	1/2"	#38 Pedestal Seal
WPAC-41A	X30ES1H18	4-1/2"	5-1/2"	1/2"	#38 Gear
WPAC-40A	X30ES1H20	3-1/8"	4-1/4"	1/2"	#38 Worm
WPAC-41B	X30ES1H9	3-1/4"	4-1/4"	11/16"	#57, #61 (#58 old style)
WPAC-41C	X30ES1H14	3-1/4"	4-1/2"	5/8"	#58 (new style)
WPAC-41D	X30ES1H17	5"	6"	1/2"	#58 Gear
WPAC-41E	X30ES1H22	3-1/4"	4-1/2"	1/2"	#58 Worm (new style)
WPAC-41	X30ES1H21	3-1/4"	4-1/4"	1/2"	#57, #61 Worm
WPAC-36F	R7311H23	2-1/8"	3-9/64"	11/16"	#25, #26, #27, #31 Worm
WPAC-36E	R7311H17	2-7/16"	3-7/16"	11/16"	#35, #36, #37 Worm
WPAC-36G	R7311H13	3-15/16"	2-5/8"	11/16"	#60 Worm
WPAC-36H	R7311H25	4"	5"	11/16"	#81 Worm



Drip Ring



Features and Benefits

- Simple and cost effective
- One-man installation In 15 Minutes
- Fits a wide range of cylinder sizes, 5.75" to 12"
- Oversized drain resists clogging
- Made from highly-durable, oil-resistant material
- Excess fluids drain via hose to collection reservoir
- The SEES PITCAN is the ideal companion for optimal maintenance.

S.E.E.S. #	Diameter	Circumference
MIS-DR1	5-3/4" - 7"	18 - 22"
MIS-DR2	7" - 8-1/2"	22 - 26"
MIS-DR3	8-1/2" - 10"	26 - 31"
MIS-DR4	10" - 12"	31 - 37-1/2"
MIS-DR5	Dover IVO Valve, Dover Inverted	
MIS-DR6	Drip Ring, 12"-15.5" Diameter, 37-1/2" - 50" Circumference	



MIS-DR4



MIS-DR1

X-Pando

S.E.E.S. #	Description
MIS-XPANDO-001	Pipe Joint, Compound 14oz Can
MIS-XPANDO-002	Pipe Joint, Compound 70oz Can
MIS-XPANDO-003	Pipe Joint, Compound 25 lb drum
MIS-XPANDO-004	Pipe Joint, Compound 50 lb drum
MIS-XPANDO-005	Pipe Joint, Compound 100 lb drum
MIS-XPANDO-006	Pipe Joint, Compound Spec #2 14oz Can
MIS-XPANDO-007	Pipe Joint, Compound Spec #2



MIS-XPANDO-001



MIS-XPANDO-003

Buffer

S.E.E.S. #	O.E.M. #	Description
PB-8000	HP8000	Elevator PU Buffer, #HP8000



PB-8000

Oil Buffers

S.E.E.S. #	Description
014-6-0017	Oiler Buffer, ZOB37 Standard Duty 315 Fpm, W switch YH38/249
ZOBS51	Oil Buffer, Standard Duty 200FPM
ZOBS55	Oil Buffer, Standard Duty 500FPM
SEES-OBSW-001	Oil Buffer Switch, Universal 1 N.O. / 1 N.C.
TOBS-001	Oil Buffer Switch, Thyssen

LIGHTING

QUICK LOCATOR GUIDE

Area Light	417
Cab Ceiling Light Diffuser	421
Cab Lighting	418-423
Drop Lights	417
Emergency Light Assemblies	417-418
Flashlights	417
Lamp Guide, Listed by Lamp number	403-405
Lamp Guide, Listed by Figure number	406-412
Lamp Holder Selection Guide	416
LED Cab Lighting	418-421, 423
LED Diagram	413-414
LED Lighting Systems	418-421
LED Retrofit Fluorescent Replacement	422
Top of Car Light & Lamp Guards	416



Did you know?
 The T-12 fluorescent lamps used in 80% of all elevators will no longer be manufactured in the United States after July 14, 2012.

What can you do?
The SEES e-Luminator LED Retrofit is the answer!



Fast, Easy Installation!

Features & Benefits

- SAVINGS** Pays for itself- uses 67% less energy than fluorescents
- QUALITY** The BEST UL certified LED retrofit kit. Exceeds minimum required lumen standards.
- PERFORMANCE** 5 Year Limited Warranty
 Rated Lifetime: 50,000 hours

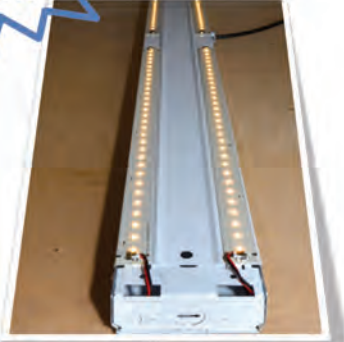

Part #: SEES-ILLUMINATOR-001

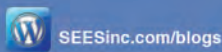

Always Smooth Sailing



Lamps Numeric Listing By Lamp



S.E.E.S. #	O.E.M. #	Volts	Watts	Bulb	Base	M.O.L.	Figure #
ML-63	10	2.5	1.25	G-3-1/2	Mini bi-pin	0.94	Fig. 5
ML-48	1004	12.8	12.032	B-6	Double Contact Bayonet	1.75	Fig. 3
ML-127	100A	120	100	A-19	Medium	4.4375	Fig. 1
ML-141	100A	230-250	100	A-19	Medium	5.3125	Fig. 1
ML-22	10C7DC	115-125	10	C-7	Double Contact Bayonet	2.19	Fig. 4
ML-105	10S11/115V	115-125	10	S-11	Candelabra Screw	2.3125	Fig. 20
ML-46	10S6/10/230	230	10	S-6	Candelabra Screw	1.88	Fig. 17
ML-15	10S6/10/250	250	10	S-6	Candelabra Screw	1.88	Fig. 17
ML-42	10S6/10DC	230	10	S-6	Double Contact Bayonet	1.82	Fig. 16
ML-20	10S6/10DC	250	10	S-6	Double Contact Bayonet	1.82	Fig. 16
ML-89	10S6/120	120	10	S-6	Candelabra Screw	1.88	Fig. 17
ML-34	10S6230RED	230.0	10.0	S-6	Double Contact Bayonet	1.81	Fig. 16
ML-35	10S6230GRN	230.0	10.0	S-6	Double Contact Bayonet	1.81	Fig. 16
ML-82	1130	6.4	16.83	S-8	Double Contact Bayonet	2.00	Fig. 19
ML-82A	1150	6.4	16.83	S-8	Double Contact Bayonet	2.00	Fig. 19
ML-36A	12	6.3	.95	G-3-1/2	Mini bi-pin	0.94	Fig. 5
ML-72	12MB	12	2.04	T-2-1/2	Mini Bayonet	1.19	Fig. 28
ML-32	12PSB	12	2.04	T-2	Slide #5	1.12	Fig. 26
ML-6	120MB	120	3	T-2-1/2	Mini Bayonet	1.19	Fig. 28
ML-6N	120MB Neon	120	2	T-2-1/2	Mini Bayonet	1.19	Fig. 28
ML-1	120PSB	120	3	T-2	Slide #5	1.12	Fig. 26
ML-1N	120PSB Neon	120	2	T-2	Slide #5	1.12	Fig. 26
ML-27A	120RB	120	3	—	Mini Bayonet	1.10	Fig. 13
ML-25	120RC	120	3	—	Candelabra Screw	1.10	Fig. 14
ML-25N	120RC Neon	120	3	—	Candelabra Screw	1.10	Fig. 14
ML-148	1224	32	5.12	G-6	Double Contact Bayonet	1.44	Fig. 11
ML-59	1251	28	6.44	G-6	Single Contact Bayonet	1.44	Fig. 10
ML-140	1383	13	19.5	R-12	Single Contact Bayonet	2.63	Fig. 12
ML-139	1434	4.0	3.7	T-5	Single Contact Bayonet	1.75	Fig. 27
ML-150	147	7.0	3.01	T-3-1/4	Wedge Base	1.06	Fig. 35
ML-21	1493	6.5	17.875	S-8	Double Contact Bayonet	2.00	Fig. 19
ML-62	15	7.0	2.80	G-4-1/2	Mini bi-pin	1.06	Fig. 8
ML-128	150A/CL/RS	120.0	150	A-21	Medium	5.3125	Fig. 1
ML-6R	155MB	155.0	2	T-2-1/2	Miniature Bayonet	1.19	Fig. 28
ML-1C	155PSB	155.0	2	T-2	Slide #5	1.12	Fig. 26
ML-84	15S11	120	15	S-11	Candelabra Screw	2.375	Fig. 20
ML-142	15T6/130VCS	130	15	T-6	Candelabra Screw	3.06	Fig. 36
ML-93	161	14	2.66	T-3-1/4	Wedge	1.06	Fig. 30
ML-56	1651	5.0	3	S-8	Single Contact Bayonet	2	Fig. 18
ML-125	1692	28	7.08	S-8	Double Contact Bayonet	2	Fig. 19
ML-124	16ESB	16	.64	T-2	Slide #5	2	Fig. 26
ML-132	1810	6.3	2.52	T-3-1/4	Mini Bayonet	1.19	Fig. 29
ML-133	1813	14.4	1.44	T-3-1/4	Mini Bayonet	1.19	Fig. 29
ML-43	1815	14.0	2.80	T-3-1/4	Mini Bayonet	1.19	Fig. 29
ML-97	1816	13.0	4.29	T-3-1/4	Mini Bayonet	1.19	Fig. 29
ML-96	1819	28.0	1.12	T-3-1/4	Mini Bayonet	1.19	Fig. 29
ML-50	1820	28.0	2.8	T-3-1/4	Mini Bayonet	1.19	Fig. 29
ML-103	1822	36.0	3.6	T-3-1/4	Mini Bayonet	1.19	Fig. 29
ML-130	1828	37.5	1.875	T-3-1/4	Mini Bayonet	1.19	Fig. 29
ML-47	1829	28.2	1.96	T-3-1/4	Mini Bayonet	1.19	Fig. 29
ML-92	1835	55.0	2.75	T-3-1/4	Mini Bayonet	1.19	Fig. 29
ML-86	1847	6.3	.945	T-3-1/4	Mini Bayonet	1.19	Fig. 29
ML-91	1850	5.0	.45	T-3-1/4	Mini Bayonet	1.19	Fig. 29
ML-11	1864	28.0	4.76	T-3-1/4	Mini Bayonet	1.19	Fig. 29



Lamps Numeric Listing By Lamp

LIGHTING

S.E.E.S. #	O.E.M. #	Volts	Watts	Bulb	Base	M.O.L.	Figure #
ML-99	1888	7.0	3.5	T-3-1/4	Mini Bayonet	1.19	Fig. 29
ML-12	1893	14.0	4.62	T-3-1/4	Mini Bayonet	1.19	Fig. 29
ML-1D	220PSB Neon	220	.25	T-2	Slide # 5	1.12	Fig. 26
ML-109	238	6.3	.50	T-3/14	Mini Bayonet	1.19	Fig. 29
ML-120	24CSB	24.0	.408	T-2	Slide #5	.92	Fig. 26
ML-36	24ESB	24.0	.96	T-2	Slide #5	0.92	Fig. 26
ML-83	24MB	24.0	1.68	T-2-1/2	Mini Bayonet	1.19	Fig. 28
ML-5	24PSB	24.0	1.752	T-2	Slide #5	1.12	Fig. 26
ML-101	24RC	24.0	1.752	—	Candelabra Screw	1.22	Fig. 14
ML-98	253	2.5	.875	TL-1-3/4	Midget Grooved	.69	Fig. 40
ML-111	253X	2.5	.875	TL-1-3/4	Midget Grooved	.69	Fig. 40
ML-24	259	6.3	1.575	T-3-1/4	Wedge	1.06	Fig. 30
ML-113A	25A15	115-125	25.0	A-15	Medium	3.5	Fig. 1
ML-54C	25S11/2C	115-125	25.0	S-11	Candelabra Screw	2.25	Fig. 20
ML-54	25S11/2C/IF	115-125	25.0	S-11	Candelabra Screw	2.25	Fig. 20
ML-131	25S6/120V	120.0	25.0	S-6	Candelabra Screw	2.625	Fig. 17
ML-90	25T8C/120C	115-125	25.0	T-8	Candelabra Screw	2.625	Fig. 37
ML-88	25T8DC-1C	115-125	25.0	T-8	Double Contact Bayonet	2.625	Fig. 36
ML-88A	25T8DC-1F	115-125	25.0	T-8	Double Contact Bayonet	2.625	Fig. 36
ML-90A	25T8N-120V	120.0	25.0	T-8	Intermediate	2.625	Fig. 39
ML-75	27	4.9	1.47	G-4-1/2	Mini Screw	1.06	Fig. 7
ML-83A	28MB	28.0	1.12	T-2-1/2	Mini Bayonet	1.19	Fig. 28
ML-4	28PSB	28.0	1.12	T-2	Slide #5	1.12	Fig. 26
ML-69	28RB	28.0	1.12	—	Mini Bayonet	1.10	Fig. 13
ML-114	28RC	28.0	1.12	—	Candelabra Screw	1.22	Fig. 14
ML-31A	302	28.0	4.76	G-5	Double Contact Bayonet	1.38	Fig. 9
ML-45	303	28.0	8.40	G-6	Single Contact Bayonet	1.44	Fig. 10
ML-73	308	28.0	18.76	S-8	Double Contact Bayonet	1.19	Fig. 19
ML-68	313	28.0	4.76	T-3-1/4	Mini Bayonet	1.19	Fig. 29
ML-107	330	14.0	1.12	T-1-3/4	S.C. Midget Flanged	0.63	Fig. 22
ML-58	344	10.0	.14	T-1-3/4	S.C. Midget Flanged	0.63	Fig. 22
ML-29	349	6.3	1.26	T-1-3/4	S.C. Midget Flanged	0.63	Fig. 22
ML-65	380	6.3	.252	T-1-3/4	S.C. Midget Flanged	0.63	Fig. 22
ML-49	381	6.3	1.26	T-1-3/4	S.C. Midget Flanged	0.63	Fig. 22
ML-95	387	28.0	1.12	T-1-3/4	S.C. Midget Flanged	0.63	Fig. 22
ML-113	40A15	115-125	40.0	A-15	Medium	3.5	Fig. 1
ML-10	44	6.3	1.575	T-3-1/4	Mini Bayonet	1.19	Fig. 29
ML-144	4546	4.7	2.35	PAR36	2 Screw Terminals	4.5	Fig. 43
ML-28	47	6.3	.945	T-3-1/4	Mini Bayonet	1.19	Fig. 29
ML-118	48ESB	48.0	1.92	T-2	Slide #5	0.92	Fig. 26
ML-83B	48MB	48.0	2.4	T-2-1/2	Mini Bayonet	1.19	Fig. 28
ML-3	48PSB	48.0	2.4	T-2	Slide #5	1.12	Fig. 26
ML-87	48RC	48.0	2.4	—	Candelabra Screw	1.22	Fig. 14
ML-30	502	5.1	.765	G-4-1/2	Mini Screw	1.06	Fig. 7
ML-31	503	5.1	.765	G-4-1/2	Mini Bayonet	1.06	Fig. 6
ML-134	55	7.0	.350	G-4-1/2	Mini Bayonet	1.06	Fig. 6
ML-76	57	14.0	3.34	G-4-1/2	Mini Bayonet	1.06	Fig. 6
ML-51	5T-N1/125V	125.0	.33	—	Capsule	1.375	Fig. 41
ML-8	60MB	60.0	3.00	T-2-1/2	Mini Bayonet	1.19	Fig. 28
ML-2	60PSB	60.0	3.00	T-2	Slide #5	1.12	Fig. 26
ML-27	60RB	60.0	3.00	—	Mini Bayonet	1.10	Fig. 13
ML-80	60RC	60.0	3.00	—	Candelabra Screw	1.22	Fig. 14
ML-145	63-029-1	28	1.92	—	Cartridge, Red	0.75	Fig. 45
ML-146	63-029-12	28	1.92	—	Cartridge, Green	0.75	Fig. 45

Lamps Numeric Listing By Lamp

S.E.E.S. #	O.E.M. #	Volts	Watts	Bulb	Base	M.O.L.	Figure #
ML-159	6435 Halogen	12	20	GBF	DC Bayonet	2.00	Fig. 13
ML-110	656	28.0	1.68	T-3-1/4	Wedge	1.06	Fig. 30
ML-57	657	28.0	2.24	T-3-1/4	Wedge	1.06	Fig. 30
ML-23	67	13.5	7.96	G-6	Single Contact Bayonet	1.44	Fig. 10
ML-135	68	13.5	7.96	G-6	Double Contact Bayonet	1.44	Fig. 11
ML-9	6MB	6.0	.840	T-2-1/2	Mini Bayonet	1.19	Fig. 28
ML-71	6PSB	6.0	.840	T-2	Slide #5	1.12	Fig. 26
ML-100	6S6/6V	6.0	6.0	S-6	Candelabra Screw	1.88	Fig. 17
ML-137	6S6/12V	12.0	6.0	S-6	Candelabra Screw	1.88	Fig. 17
ML-39	6S6/30V	30.0	6.0	S-6	Candelabra Screw	1.88	Fig. 17
ML-119	6S6/48V	48.0	6.0	S-6	Candelabra Screw	1.88	Fig. 17
ML-119A	6S6/60V	60.0	6.0	S-6	Candelabra Screw	1.88	Fig. 17
ML-18	6S6/120V	120.0	6.0	S-6	Candelabra Screw	1.88	Fig. 17
ML-85	6S6/130V	130.0	6.0	S-6	Candelabra Screw	1.88	Fig. 17
ML-77	6S6/145V	145.0	6.0	S-6	Candelabra Screw	1.88	Fig. 17
ML-17	6S6/155V	155.0	6.0	S-6	Candelabra Screw	1.88	Fig. 17
ML-26	6S6/DC/30V	30.0	6.0	S-6	Double Contact Bayonet	1.82	Fig. 16
ML-102	6S6/DC/48V	48.0	6.0	S-6	Double Contact Bayonet	1.88	Fig. 16
ML-66	6S6/DC/60V	60.0	6.0	S-6	Double Contact Bayonet	1.88	Fig. 16
ML-60	6S6/DC/120V	120.0	6.0	S-6	Double Contact Bayonet	1.82	Fig. 16
ML-78	6S6/DC/125V	125.0	6.0	S-6	Double Contact Bayonet	1.82	Fig. 16
ML-19	6S6/DC/145V	145.0	6.0	S-6	Double Contact Bayonet	1.82	Fig. 16
ML-122	6S6/SCB/150	150.0	6.0	S-6	Single Contact Bayonet	1.88	Fig. 15
ML-122A	6S6/SCB/155	155.0	6.0	S-6	Single Contact Bayonet	1.50	Fig. 15
ML-143	73	14	1.12	T-1-3/4	Subminiature Wedge	.80	Fig. 23
ML-74	7327	28.0	1.12	T-1-3/4	Bi-pin	.63	Fig. 24
ML-33	757	28.0	1.68	T-1-3/4	Mini Bayonet	1.19	Fig. 29
ML-138	81	6.5	6.63	G-6	Single Contact Bayonet	1.44	Fig. 10
ML-108	85	28.0	1.12	T-1-3/4	Subminiature Wedge	.80	Fig. 23
ML-104	85E	28.0	1.12	T-1-3/4	Wire Terminals	.80	Fig. 25
ML-94	88	6.8	12.98	S-8	Double Contact Bayonet	2.00	Fig. 19
ML-81	90	13.0	7.54	G-6	Double Contact Bayonet	1.44	Fig. 11
ML-7	90MB	90.0	2.7	T-2-1/2	Mini Bayonet	1.19	Fig. 28
ML-147	94	12.8	13.31	S-8	Double Contact Bayonet	2.00	Fig. 19
ML-38	965	9.84	4.92	T-4-1/2	Mini Screw	1.45	Fig. 32
ML-37	97	13.5	9.31	G-6	Single Contact Bayonet	1.44	Fig. 10
ML-136	F6T5/CW	6.0	.882	T-5	Mini Bi-Pin	9.00	Fig. 39
ML-157	F8T5CW	Multi	8	T-%	Med Bi-Pin	12	Fig. 41
ML-126	LMM-2	2.75	—	T-1	Bi-Pin	.375	Fig. 21
ML-149	NE2J(C9A)	120	—	T-2	S.C. Midget Flanged	.94	Fig. 27A
ML-13	NE51(B1A)	—	—	T-3-1/4	Mini Bayonet	1.19	Fig. 29
ML-14	NE51(B2A)	—	—	T-3-1/4	Mini Bayonet	1.19	Fig. 29
ML-129	PR-2	2.38	1.19	B-3-1/2	S.C. Miniature Flanged	1.25	Fig. 2
ML-158	Q20GYB	120	20	GYB	Bi-Pin	1.375	Fig. 21
ML-121N	T-2	120.0	.33	T-2	Mini Bayonet	1.00	Fig. 27
ML-52	T-4	130.0	6.0	T-4	Candelabra Screw	1.375	Fig. 31
ML-67	T-4-1/2	130.0	4.0	T-4-1/2	Candelabra Screw	1.375	Fig. 33
ML-67A	T-4-1/2	225-250	5-7	T-4-1/2	Candelabra Screw	1.625	Fig. 33
ML-41	T-4-1/2	130.0	4.0	T-4-1/2	Double Contact Bayonet	1.50	Fig. 34
ML-44	T-4-1/2-DC	120.0	6.0	T-4-1/2	Double Contact Bayonet	1.75	Fig. 34
ML-40	T-4-1/2-DC	250.0	7.0	T-4-1/2	Double Contact Bayonet	1.625	Fig. 34
ML-40A	T-4-1/2-CS	250.0	7.0	T-4-1/2	Double Contact Bayonet	1.75	Fig. 34
ML-40B	T1654B15Y	250.0	7.0	T-4-1/2	Double Contact Bayonet	2.00	Fig. 34
ML-112	T8/10V/5A	10.0	5.0	T-8	Double Contact Bayonet	3.00	Fig. 36
ML-121NR	X46EA	120.0	—	T-2-1/2	Miniature Bayonet (Neon)	1.19	Fig. 28

Lamps – By Figure

#1 Appliance Lamp

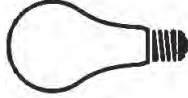

S.E.E.S. #	Lamp #	Volts	Watts	M.O.L.
ML-113A	25A15	115-125	25.0	3.5
ML-113	40A15	115-125	40.0	3.5
ML-127	100A	120	100	4.4375
ML-141	100A	230-250	100	5.3125
ML-128	150A/CL/RS	120	150	5.3125



#2 B-3-1/2 Single Contact Mini Flanged

S.E.E.S. #	Lamp #	Volts	Watts	M.O.L.
ML-129	PR-2	2.38	1.19	1.25

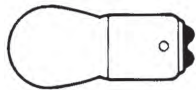

#3 B-6 Double Contact Bayonet

S.E.E.S. #	Lamp #	Volts	Watts	M.O.L.
ML-48	1004	12.8	12.032	1.75

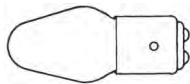

#4 C-7 Double Contact Bayonet

S.E.E.S. #	Lamp #	Volts	Watts	M.O.L.
ML-22	10C7DC	115-125	10	2.19



#5 G-3-1/2 Mini Bi-Pin

S.E.E.S. #	Lamp #	Volts	Watts	M.O.L.
ML-63	10	2.5	1.25	.94
ML-36A	12	6.3	.95	.94



ML-160

#5A G-3-1/2 Mini Bayonet

S.E.E.S. #	Lamp #	Volts	Watts	M.O.L.
ML-160	51	7.5	1.7	.94

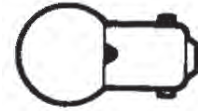

#6 G-4-1/2 Mini Bayonet

S.E.E.S. #	Lamp #	Volts	Watts	M.O.L.
ML-31	503	5.1	.765	1.06
ML-134	55	7.0	.350	1.06
ML-76	57	14.0	3.34	1.06

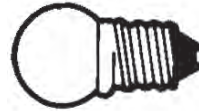

ML-152

#7 G-3-1/2 Mini Screw

S.E.E.S. #	Lamp #	Volts	Watts	M.O.L.
ML-152	1449	14	.3	.94

#7 G-4-1/2 Mini Screw

S.E.E.S. #	Lamp #	Volts	Watts	M.O.L.
ML-75	27	4.9	1.47	1.06
ML-30	502	5.1	.765	1.06

S.E.E.S. # Description

ML-30-LED-W Lamp, 502 white LED



#8 G-4-1/2 Mini Bi-Pin

S.E.E.S. #	Lamp #	Volts	Watts	M.O.L.
ML-62	15	7.0	2.80	1.06

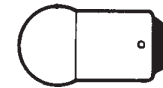

#9 G-5 Double Contact Bayonet

S.E.E.S. #	Lamp #	Volts	Watts	M.O.L.
ML-31A	302	28.0	4.76	1.38

S.E.E.S. # Description

ML-31-LED-W Lamp, 503 white LED

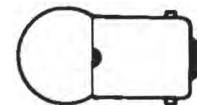

#10 G-6-1/2 Single Contact Bayonet

S.E.E.S. #	Lamp #	Volts	Watts	M.O.L.
ML-138	81	6.5	6.63	1.44
ML-23	67	13.5	7.96	1.44
ML-37	97	13.5	9.31	1.44
ML-59	1251	28.0	6.44	1.44
ML-45	303	28.0	18.76	1.44

Lamps – By Figure

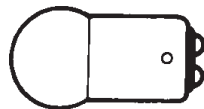

#11 G-6 Double Contact Bayonet

S.E.E.S. #	Lamp #	Volts	Watts	M.O.L.
ML-81	90	13.0	7.54	1.44
ML-135	68	13.5	7.96	1.44
ML-148	1224	32	5.12	1.44

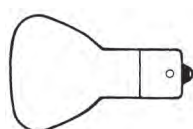

#12 R-12 Single Contact Bayonet

S.E.E.S. #	Lamp #	Volts	Watts	M.O.L.
ML-140	1383	13	19.5	2.63
ML-140A	1383	13	19.5	2.63

S.E.E.S. #	Description
ML-140-LED-WHITE	Lamp, 1383 with Tuff Coating

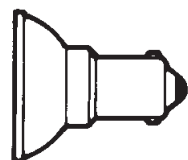

#13 Annunciator Bayonet Base

S.E.E.S. #	Lamp #	Volts	Watts	M.O.L.
ML-69	28RB	28	1.12	1.10
ML-27	60RB	60	3	1.10
ML-27A	120RB	120	3	1.12
ML-159	6435H	12	20	2

S.E.E.S. #	Description
ML-27-LED-W	Lamp, warm white LED to replace 60RB lamp

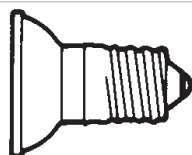

#14 Annunciator Candelabra Base

S.E.E.S. #	Lamp #	Volts	Watts	M.O.L.
ML-101	24RC	24.0	1.752	1.22
ML-114	28RC	28.0	1.12	1.22
ML-87	48RC	48.0	2.4	1.22
ML-80	60RC	60.0	.300	1.22
ML-25	120RC	120	3	1.10
ML-25N	120RC Neon 120	120	3	1.10



#15 S-6 Single Contact Bayonet

S.E.E.S. #	Lamp #	Volts	Watts	M.O.L.
ML-122	6S6/SCB	150.0	6.0	1.88
ML-122A	6S6/SCB	155.0	6.0	1.50

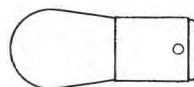

#16 S-6 Double Contact Bayonet

S.E.E.S. #	Lamp #	Volts	Watts	M.O.L.
ML-26	6S6/DC/30	30	6	1.82
ML-102	6S6/DC/48	48	6	1.88
ML-66	6S6/DC/60	60	6	1.88
ML-60	6S6/DC/120	120	6	1.82
ML-78	6S6/DC/125	125	6	1.82
ML-19	6S6/DC/145	145	6	1.82
ML-42	10S6/10DC	230	10	1.82
ML-20	10S6/10DC	250	10	1.82
ML-34	10S6/230 Red	230	10	1.81
ML-35	10S6/230 Grn	230	10	1.81

S.E.E.S. #	Description
ML-26-LED-W	Lamp, LED, 6S6 DC 30V



ML-26-LED-W

Lamps – By Figure

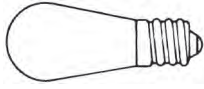

#17 S-6 Candelabra Screw

S.E.E.S. #	Lamp #	Volts	Watts	M.O.L.
ML-100	6S6/6	6	6	1.88
ML-137	6S6/12	12	6	1.88
ML-39	6S6/30	30	6	1.88
ML-119	6S6/48	48	6	1.88
ML-119A	6S6/60	60	6	1.88
ML-18	6S6/120	120	6	1.88
ML-85	6S6/130	130	6	1.88
ML-77	6S6/145	145	6	1.88
ML-17	6S6/155	155	6	1.88
ML-89	10S6/120	120	10	1.88
ML-46	10S6/10/230	230	10	1.88
ML-15	10S6/10/250	250	10	1.88
ML-131	25S6/120	120	25	2.625

S.E.E.S. #	Description
ML-155	Lamp, 6S6V C.S. 6 watt

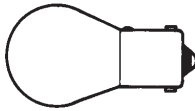

#18 S-8 Single Contact Bayonet

S.E.E.S. #	Lamp #	Volts	Watts	M.O.L.
ML-56	1651	5.0	3	2

S.E.E.S. #	Description
ML-161	Lamp, S-8 Type 12.8V 2.1A S.C Bayonette Base

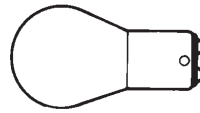

#19 S-8 Double Contact Bayonet

S.E.E.S. #	Lamp #	Volts	Watts	M.O.L.
ML-82	1130	6.4	16.83	2.00
ML-82A	1150	6.4	16.83	2.00
ML-21	1493	6.5	17.88	2.00
ML-94	88	6.8	12.98	2.00
ML-147	94	12.8	13.31	2.00
ML-125	1692	28.0	17.08	2.00
ML-73	308	28.0	18.76	2.00
ML-153	306	28.0	14	2.00

S.E.E.S. #	Description
ML-73-LED-W	Lamp, LED White, 28V, S-8, Double Bayonet Base

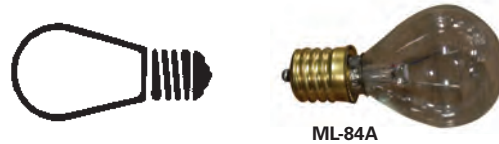

#20 S-11 Candelabra Screw

S.E.E.S. #	Lamp #	Volts	Watts	M.O.L.
ML-105*	10S11N/115V	115-125	10	2.3125
ML-54C	25S11/2C	115-125	25	2.25
ML-54	25S11/2C/IF	115-125	25	2.25
ML-84	15S11	120	15	2.375

S.E.E.S. #	Description
ML-84A	Lamp, 25S11, 28V Candelabra Screw Base with Reducer

S.E.E.S. #	Description
ML-54D-LED-W	Lamp, 28V 1.8W, Candelabra Screw, sold individual

*Intermediate Base



Lamps – By Figure



#21 T-1 Bi-pin

S.E.E.S. #	Lamp #	Volts	Watts	M.O.L.
ML-126	LMM-2	2.75	—	.375
ML-158	Q20GYB	120	20	1.375



#22 T-1-3/4 Single Contact Midget

S.E.E.S. #	Lamp #	Volts	Watts	M.O.L.
ML-65	380	6.3	.252	.63
ML-29	349	6.3	1.26	.63
ML-49	381	6.3	1.26	.63
ML-58	344	10.0	.14	.63
ML-107	330	14.0	1.12	.63
ML-95	387	28.0	1.12	.63



#24 T-1-3/4 Bi-pin

S.E.E.S. #	Lamp #	Volts	Watts	M.O.L.
ML-74	7327	28.0	1.12	.63



#25 T-1-3/4 Wire Terminal

S.E.E.S. #	Lamp #	Volts	Watts	M.O.L.
ML-104	85E	28.0	1.12	.80



#23 T-1-3/4 Subminiature Wedge

S.E.E.S. #	Lamp #	Volts	Watts	M.O.L.
ML-143	73	14.0	1.12	.80
ML-108	85	28.0	1.12	.80

S.E.E.S. #	Description
ML-108-LED-G	Lamp, Green LED to replace #85 lamp
ML-108-LED-O	Lamp, Orange LED to replace #85 lamp
ML-108-LED-R	Lamp, Red LED to replace #85 lamp
ML-108-LED-W	Lamp, Warm White LED to replace #85 lamp
ML-108-LED-Y	Lamp, Yellow LED to replace #85 lamp
ML-108-LED-O-PACK	Lamp, Orange LED (10PK), #85 lamp
ML-85A-LED-R	Lamp, 28V LED, Red, Sold Individual
ML-85A-LED-W	Lamp, 28V LED, White, Sold Individual



ML-108-LED-G

ML-108-LED-Y

ML-108-LED-W



ML-108-LED-R



ML-108-LED-B



ML-85A-LED-W



ML-85A-LED-R

Lamps – By Figure



ML-164

#26 T-2 #5 Slide Base

S.E.E.S. #	Lamp #	Volts	Watts	M.O.L.
ML-120	24CSB	24	.408	.92
ML-124	16ESB	16	.64	2
ML-36	24ESB	24	.96	.92
ML-118	48ESB	48	1.92	.92
ML-71	6PSB	6	.840	1.12
ML-32	12PSB	12	2.04	1.12
ML-5	24PSB	24	1.752	1.752
ML-4	28PSB	28	1.12	1.12
ML-3	48PSB	48	2.4	1.12
ML-2	60PSB	60	3	1.12
ML-1N	120PSBneon	120	2	1.12
ML-1C	155PSB	155	2	1.12
ML-1	120PSB	120	3	1.12
ML-1D	220PSB	220	.25	1.12
ML-35A	35PSB	35V	.045 (amps)	

S.E.E.S. #	Description
ML-71-LED-R	Lamp, LED Red, 6V
ML-32-LED-R	Lamp, LED Red, 12V T-2 #5 Base
ML-5-LED-W	Lamp, White, to replace #24PSB
ML-5-LED-Y	Lamp, Yellow, to replace #24PSB
ML-2-LED-W	Lamp, White #60 PSB LED
ML-1-LED-R	Lamp, Red LED to replace #120PSB
ML-1-LED-W	Lamp, Warm White LED to replace #120PSB
ML-1-LED-Y	Lamp, Yellow LED to replace #120PSB
ML-1-LED-B	Lamp, 120 PSB Lamp, Blue LED, 6 Chip

T-2 BA7s Base

S.E.E.S. #	Lamp #	Fig. #	Volts	Watts	M.O.L.
ML-164	T-2		24	3	.875



#28 T-2-1/2 Mini Bayonet

S.E.E.S. #	Lamp #	Volts	Watts	M.O.L.
ML-9	6MB	6	.840	1.19
ML-72	12MB	12	2.04	1.19
ML-83	24MB	24	1.68	1.19
ML-83A	28MB	28	1.12	1.19
ML-83B	48MB	48	2.4	1.19
ML-8	60MB	60	3	1.19
ML-7	90MB	90.0	2.7	1.19
ML-6	120MB	120	3	1.19
ML-6N	120MBneon	120	2	1.19
ML-6R	155MB	155	2	1.19
ML-121NR	X46EA	120	—	1.19

S.E.E.S. #	Description
ML-7-LED-Y	Lamp, 90MB LED yellow
ML-7-LED-R	Lamp, 90MB LED red
ML-7-LED-W	Lamp, 90MB LED white



ML-35A



ML-5-LED-W



ML-7-LED-Y



ML-7-LED-R



ML-2-LED-W



ML-1-LED-B



ML-7-LED-W



#27 T-2 Mini Bayonet

#27A T-2 Single Contact Midget Flanged

S.E.E.S. #	Lamp #	Fig. #	Volts	Watts	M.O.L.
ML-121N	T-2	27	120	.33	1.00
ML-149	T-2	27A	120	.25	.94

Lamps – By Figure



#29 T-3-1/4 Mini Bayonet

S.E.E.S. #	Lamp #	Volts	Watts	M.O.L.
ML-13	NE51(B1A)			1.19
ML-14	NE51(B2A)			1.19
ML-91	1850	5	.45	1.19
ML-109	238	6.3	.50	1.19
ML-28	47	6.3	.945	1.19
ML-86	1847	6.3	.945	1.19
ML-10	44	6.3	1.575	1.19
ML-132	1810	6.3	2.52	1.19
ML-99	1888	7	3.5	1.19
ML-97	1816	13	4.29	1.19
ML-43	1815	14	2.80	1.19
ML-12	1893	14	4.62	1.19
ML-133	1813	14.4	1.44	1.19
ML-115A	1843	28	.616	1.19
ML-96	1819	28	1.12	1.19
ML-33	757	28	1.68	1.19
ML-33A	756			
ML-47	1829	28	1.96	1.19
ML-50	1820	28	2.8	1.19
ML-68	313	28	4.76	1.19
ML-11	1864	28	4.76	1.19
ML-103	1822	36	3.6	1.19
ML-130	1828	37.5	1.875	1.19
ML-92	1835	55	2.75	1.19

S.E.E.S. #	Description
ML-10-LED-W	Lamp, #44 LED White 6V AC/DC
ML-43-LED-W	Lamp, 12V, 1815 LED White



ML-10-LED-W



ML-43-LED-W



#30 T-3-1/4 Wedge

S.E.E.S. #	Lamp #	Volts	Watts	M.O.L.
ML-24	259	6.3	1.575	1.06
ML-150	147	7	3.01	1.06
ML-93	161	14	2.66	1.06
ML-110	656	28	1.68	1.06
ML-57	657	28	2.24	1.06

S.E.E.S. #	Description
ML-57-LED-W	Lamp, White 28V LED 4 Chip



ML-57-LED-W



#31 T-4 Candelabra Screw

S.E.E.S. #	Lamp #	Volts	Watts	M.O.L.
ML-52	T-4	130	6	1.375

Lamps – By Figure

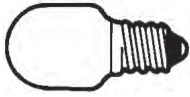

#32 T-4-1/2 Mini Screw

S.E.E.S. #	Lamp #	Volts	Watts	M.O.L.
ML-38	965	9.84	4.92	1.45



#33 T-4-1/2 Candelabra Screw

#34 T-4-1/2 Double Contact Bayonet

S.E.E.S. #	Lamp #	Volts	Watts	M.O.L.
ML-67	T-4-1/2, Fig. 33	130	4.5	1.375
ML-67A	T-4-1/2, Fig. 33	225-250	5-7	1.625
ML-44	T-4-1/2, Fig. 34	120	6	1.75
ML-41	T-4-1/2, Fig. 34	130	4	1.50
ML-40	T-4-1/2, Fig. 34	250	7	1.625
ML-40A	T-4-1/2, Fig. 34	250	7	1.75
ML-40B	T-4-1/2, Fig. 34	250	7	2.00

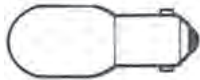

#35 T-5 Single Contact Bayonet Base

S.E.E.S. #	Lamp #	Volts	Watts	M.O.L.
ML-139	1434	4.0	13	1.75

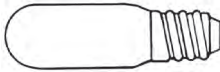

#36 T-6 Candelabra Screw

S.E.E.S. #	Lamp #	Volts	Watts	M.O.L.
ML-142	15T6	130	15.6	3.06



#37 T-8 Candelabra Screw

#38 T-8 Double Contact Bayonet

S.E.E.S. #	Lamp #	Volts	Watts	M.O.L.
ML-90	25T8, Fig. 37	115-125	25	2.625
ML-112	25T8, Fig. 38	10	5	3.00
ML-88	25T8, Fig. 38 Clear	115-125	25	2.625
ML-88A	25T8, Fig. 38 Frosted	115-125	25	2.625



ML-88A



#39 T-8 Intermediate Screw

S.E.E.S. #	Lamp #	Volts	Watts	M.O.L.
ML-90A	25T8N	120	25	2.625



#40 TL-1-3/4

S.E.E.S. #	Lamp #	Volts	Watts	M.O.L.
ML-98	253	2.5	.875	.69
ML-111	253X	2.5	.875	.69

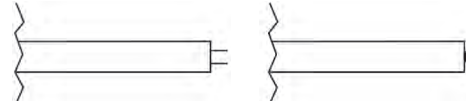

#41 T-5 Midget Grooved Fluorescent

#42 Lumiline Disc

S.E.E.S. #	Lamp #	Volts	Watts	M.O.L.
ML-136	F6T5/CW, Fig. 41	6	.882	9.00

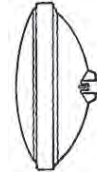

#43 2 Screw Terminal

S.E.E.S. #	Lamp #	Volts	Watts	M.O.L.
ML-144	4546	4.7	2.5	4.50



#44 Neon Capsule

#45 Cartridge Lamps

S.E.E.S. #	Lamp #	Volts	Watts	M.O.L.
ML-51	5T-N1, Fig. 44	125	.33	1.375
ML-145	63-029-1R, Fig. 45	28	1.12	.75
ML-146	63-029-2G, Fig. 45	28	1.12	.75

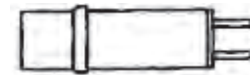

LED Diagram

SEES Lamp Series	Replaces Incandescent		Voltage	Lamp Type	Applications	Colors Available
ML-108-LED-	85		28V	T1-3/4 (5mm) Subminiature Wedge Based LEDs	Position Indicator Buttons Elevator Floor Buttons Elevator Call Buttons	Red ● Orange ● Yellow ● White ○ Green ●
ML-4-LED-	28PSB		28V	T2 #5 Telephone Slide Based LEDs	Position Indicator Buttons Elevator Floor Buttons Elevator Call Buttons	Red ● Yellow ● White ○ Blue (ML-1) ●
ML-3-LED-	48PSB		48V			
ML-1-LED-	120PSB		120VAC			
ML-83-LED-	24MB		24V	T3 -1/4 (9mm) Miniature Bayonet Based LEDs	Position Indicator Buttons Elevator Floor Buttons Elevator Call Buttons	Red ● Yellow ● White ○
ML-83A-LED-	28MB/1819-1829		24V			
ML-83B-LED-	48MB		48V			
ML-6-LED-	120MB		120VAC 120VDC			
ML-18-LED-	6S6		120VAC	S6 Candelabra Screw Based LEDs	Position Indicator Buttons Elevator Floor Buttons Elevator Call Buttons	Red ● Yellow ● White ○
ML-159-LED-W	GBF/6435		12V	GBF/6435 Bayonet Base	Elevator Cabs	White ○
ML-140-LED-WHITE	1383		12V	GBF/6435 Bayonet Base	Elevator Cabs	White ○
ML-169-LED-W	MR116		12VDC 12VAC	GBF/6435 Bayonet Base	Elevator Cabs	White ○
ML-161-LED-W	MR16		12VDC 12VAC	GBF/6435 Bayonet Base	Elevator Cabs	White ○
ML-27-LED-W	60RB		12V	60 RB LED w/ white lamp	Position Indicator Buttons	White ○
ML-26-LED-W	6S6 DC		30V	S-6 Double Contact Bayonet	Position Indicator Buttons	White ○
ML-54D-LED-W	S-11		28V	S-11 Candelabra Screw	Elevator Cabs	White ○
ML-73-LED-W	S-8		28V	S-8 Double Contact Bayonet	Position Indicator Buttons	White ○

LED Diagram

SEES Lamp Series	Replaces Incandescent		Voltage	Lamp Type	Applications	Colors Available
ML-85A-LED-	T-1-3/4		28V	T-1-3/4 Subminiature Wedge	Position Indicator Buttons Elevator Floor Buttons Elevator Call Buttons	Red  White 
ML-43-LED-W	1815		12V	T-3-1/4 Mini Bayonet	Position Indicator Buttons Elevator Floor Buttons Elevator Call Buttons	White 
ML-2-LED-W	#60 PSB		60V	T-2 #5 Slide Base	Position Indicator Buttons	White 
ML-5-LED-W	24PSB		28V	T-2 #5 Slide Base	Position Indicator Buttons	Yellow  White 
ML-10-LED-W	#44		6V	T-3-1/4 Mini Bayonet	Position Indicator Buttons	White 
ML-7-LED-	90MB		90V	T-2-1/2 Mini Bayonet	Position Indicator Buttons	Red  Yellow  White 
ML-43-LED-W	1815		12V	T-3-1/4 Mini Bayonet	Position Indicator Buttons	White 
ML-57-LED-W	T-3-1/4 Wedge		28V	T-3-1/4 Wedge	Position Indicator Buttons	White 



FEATURES

- Maintenance free, easy installation
- Long life 100,000 + hrs (10 Years)
- Solid-state, high shock/vibration resistance
- Built-in current limiting resistors
- Low power consumption, high intensity
- Major reduction in heat generation

OPTIONS

- Special voltages
- Industry standard bases
- Bi-Color configuration
- Flashing

SEES FIXTURES

SEES
SOUTHERN ELEVATOR
& ELECTRIC SUPPLY

*Add class & durability
to your elevator with
SEES fixtures*



*2-3 Week Lead Time on
Most Fixture Orders
& Competitive Pricing*



*Retrofit Packages and
Custom Sizes Available*



*Variety of Premium
Quality Components*

WHY CHOOSE US?

Over the last 45 years SEES has strived to offer the best solutions to all industry demands. We are now extending our innovation and superior quality trademark to the world of elevator fixtures.



SEES Inc



SEESParts



SEES, Inc.

Always Smooth Sailing

2781 West McNab Rd, Pompano Beach, FL 33069 • (800) 526-0026 • www.SEESinc.com

Lamp Holder Selection Guide

Lamp Holders

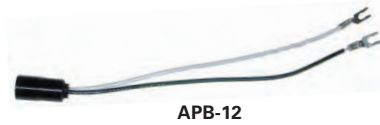

APB-12

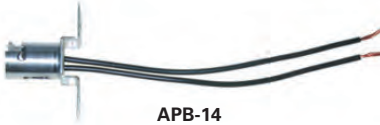

APB-14



APB-15



DB-29



DB-52



DB-52A



DB-52C



MIS-198



MLS-2



MLS-11



WB-31



WB-32

S.E.E.S. #	Description
APB-12	Lamp socket with leads for mini bayonet lamps
APB-14	Lamp socket for position indicator double contact bayonet base lamp
APB-15	Lamp socket for position indicator, T-2-1/2, miniature bayonet base lamp
DB-29	Lamp holder assembly for type T-1-3/4 subminiature wedge base lamp
DB-52	Lamp socket for T-1-3/4 subminiature wedge base lamps
DB-52A	Lamp holder assembly with resistor
DB-52B	Lamp holder as above but without resistor
DB-52C	Lamp holder assembly with resistor
DB-52D	Lamp holder as above but without resistor
DB-52E	Lamp holder for PSB lamps
MIS-198	Lamp socket for EPCO button assemblies
ML-1A	Fastening clip, 34376
MLS-2	Lamp socket, PSB, round
MLS-11	Lamp socket bay / Cand Double Cnt surface mount with U-bracket (2) 6" LDS
WB-31	Lamp holder with two wire leads for miniature bayonet base lamps
WB-32	Lamp socket for miniature bayonet base lamps
XCNT-192	Lamp socket, Medium Base Porcelain Snap In Holder

Car Top Light & Lamp Guards

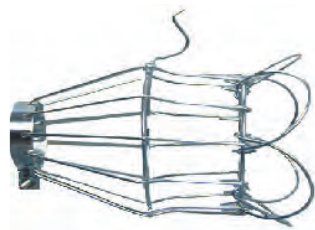

MIS-147

S.E.E.S. #	Description
MIS-147	Lamp Guard, metal clamp on guard for Car Top Inspection Station
MIS-147A	Lamp Guard, for Car Top Inspection ION/Plastic, 109789
MIS-147B	Car Top Light, magnetic base with flex neck & 25ft cord
MIS-147B-P	Car Top Light, magnetic base with flex neck & 25ft cord with plug
MIS-147C	Light Bulb Guard, Tapered For TOC, with Screw Holders
MIS-147D	LG-Grounded Metal Lamp Guard, For TOC
ML-FLG	Fluorescent Lamp Guard, 4" long, green, (slit)



MIS-147A



MIS-147B



MIS-147C



MIS-147D

Drop Lights

S.E.E.S. #	Description
MIS-920	Drop Light , Fluorescent Work Light 120V 25' Cord with Outlet
MIS-921	Drop Light , Fluorescent Work Light 15W 25' Cord with 100V Tool Tap
MIS-922	Drop Light , Fluorescent Work Light 15W 50' Cord with 100V Tool Tap



Flashlights

S.E.E.S. #	O.E.M. #	Description
MIS-TOOL-001		Flashlight , 9 LED, extra bright, with SEES logo
MIS-TOOL-004	EMF-1	Flashlight , Extendable LED 6-21", includes magnetic tip
MIS-TOOL-005	EMF-2	Flashlight , Extendable Magnetic LED 21", includes inspection mirror & clip
MIS-TOOL-006	MSL-1	Stick Light , Magnetic LED Water Resistant, includes AAA Battery
MIS-TOOL-011	PJL-1	Portable Light , 10W COB LED, Cordless, Magnetic



Area Light

S.E.E.S. #	O.E.M. #	Description
MIS-TOOL-007	PAL-1	Area Light , Pocket Size LED Water Resistant, includes AAA Battery



Emergency Light

S.E.E.S. #	Description
MIS-194A	Emergency Light , self contained, tamper resistant, easily installed surface mounts above or near car station, 120V, stainless steel, 10" x 5-3/8" x 1-3/4" with white frosted durable plastic lens. Uses MIS-194 battery. Uses ML-30 and ML-31 Lamps. Battery and lamps included.
MIS-194AL	Replacement Lens for Emergency Light, 5.1" x 9.4", white frosted durable plastic
MIS-194L	Emergency Light , self contained, tamper resistant, easily installed surface mounts above or near car station, 120V, stainless steel, 9-3/4" x 5-1/4" x 2" with white frosted durable plastic lens
MIS-907	Slimline Emergency Light , Car top power supply with attached alarm bell and remote slimline fixture. Easily installed, proven reliable for years of maintenance free operation
MIS-907A	Replacement Light , Slimline for MIS-907
MIS-907B	Mon-ELight Kit , MES964B
SEES-EML-001	Emergency Light Board , 120/220V Input, 12V LED, 6/12V Bell Output
SEES-EML-002	Emergency Light Board , 120V Input, 6/12V LED, 6/12V Bell Output
SEES-EML-003	Emergency Light Board , 120/240V Input, 6/12V Bell, 6 LED Sub Board



EPCO Emergency Lights

S.E.E.S. #	O.E.M. #	Description
1001-22-00	1001-22-00	Light Fixture , CSM 12V light
1001-43-00	1001-43-00	Light Fixture , CSM 6V light
1002-22-00	1002-22-00	Light Fixture , WRM 12V light
1002-43-00	1002-43-00	Light Fixture , WRM 6V light





1003-43-00



1006-33-00



1009-11-00-S

EPCO Emergency Lights

S.E.E.S. #	O.E.M. #	Description
1003-22-00	1003-22-00	Light Fixture, WSM 12V light
1003-43-00	1003-43-00	Light Fixture, WSM 6V light
1006-33-00	1006-33-00	Light Fixture, SBF 6V light
1009-11-00-S	1009-11-00-S	Light Fixture, NSMS Nicad Self-Contained light
ELU-4	ELU-4	Emergency Light, Mini-Fluorescent light
EPP-001	1000-02-01	EPCO Power Pack, 12V
EPP-001A	1000-03-01	EPCO Power Pack, 6V
EPP-002	1000-02-02	EPCO Power Pack, 12V with Light
EPP-002A	1000-03-02	EPCO Power Pack, 6V with Light
EPP-003	1000-02-03	EPCO Power Pack, 12V with Bell
EPP-003A	1000-03-03	EPCO Power Pack, 6V with Bell
EPP-004	1000-02-04	EPCO Power Pack, 12V with Light, Bell, & GFI
EPP-004A	1000-03-04	EPCO Power Pack, 6V with Light, Bell, & GFI

■ SEES battery selection for emergency lights on page 370-371.

LED Lighting Systems

i2SYSTEMS LINEAR LIGHTING SYSTEMS

S1205 linear dimmable LED lamps and power supplies



Part Number	Description	Length
S1205B-16CBB	S1205 warm white lamp	12 inches • 316 mm
S1205B-16BBD	S1205 neutral white lamp	12 inches • 316 mm
S1205B-86CBB	S1205 warm white lamp	18 inches • 468 mm
S1205B-86BBD	S1205 neutral white lamp	18 inches • 468 mm
S1205B-26CBB	S1205 warm white lamp	24 inches • 621 mm
S1205B-26BBD	S1205 neutral white lamp	24 inches • 621 mm
S1205B-36CBB	S1205 warm white lamp	36 inches • 621 mm
S1205B-36BBD	S1205 neutral white lamp	36 inches • 621 mm
S1205B-46CBB	S1205 warm white lamp	48 inches • 1230 mm
S1205B-46BBD	S1205 neutral white lamp	48 inches • 1230 mm
PS24V75W-E01D	Power box	
LL-101-01	LightLink dimmer	

NOTE: Each power box will power up to 20 feet of lamps - plan accordingly,



S1205B lamps are long strips of evenly lit LED covering 12 to 48 inch lengths with a very wide (65°) throw. This eliminates dark spots (socket shadow) between lamps. The Gen5 designation means that these lamps use power more efficiently.

The S1205B system has been engineered specifically for elevators in that a standard cab uses 20 feet of linear lamps – a single power supply comfortably delivers the necessary wattage. Where dimming is required, simply plug a LightLink dimmer into the power box.

Installation is simple – each lamp has a 6 foot cable that easily plugs into the power box. Adjustable brackets allow the linear lamps to be mounted either flat or pivoted on a drop ceiling.

Features

- Available in 12, 18, 24, 36 and 48 inch lengths
- Industry's best color rendering (CRI 90+)
- Light beam engineered specifically for elevators
- Simple installation – custom mounting brackets, wiring is plug and play
- Lightweight power box with dimming and optional battery backup
- cULus, RoHS, IGCC, uses LM-80 tested LEDs, LM-79 tested
- Made in the USA

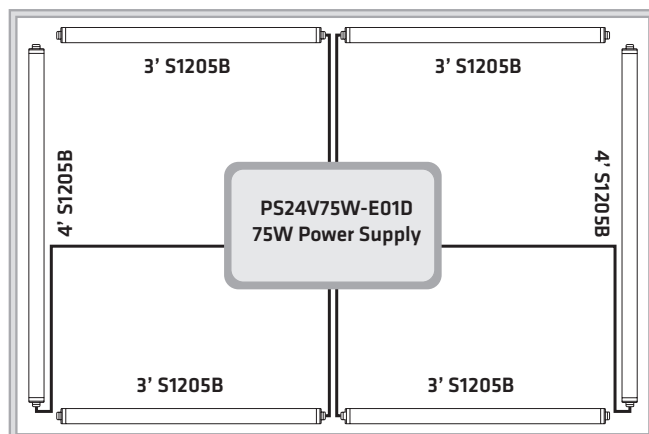

Mounting Brackets for Linear LEDs
Order two for each lamp

Part Number	Description
SLA-1	Adjustable mounting bracket
SLA-2	Fixed mounting bracket
SLA-3	End mount pivot

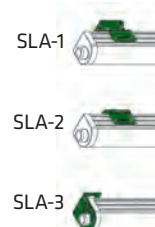

LED Lighting Systems

i2SYSTEMS ESCALATOR DEMARICATION LAMPS

S1203 Escalator Demarcation LEDs



Part Number	Description
S1203A-86D	Escalator demarcation lamp for damp conditions, 18", 9W, vibrant green light
PS24V60W-01	Power supply for up to two S1203 lamps
SLA-1	Adjustable mounting bracket for S1203, stainless steel, for damp areas
SLA-2	Fixed mounting bracket for S1203, stainless steel, for damp areas
SLA-3	End-mount pivot mounting bracket for S1203, stainless steel, for damp areas

Escalator demarcation LEDs are designed for damp and wet conditions. They offer the same operating advantages (longevity, low operating cost, light quality) as the other i2Systems LED lamps.

S1203 escalator demarcation lamps are part of our super-efficient Gen5 family of lamps. These 9 watt lamps offer rugged military-spec aluminum and polycarbonate construction. The lamps connect to the power supply with the attached 6 foot cables. Use one power supply and two lamps for each landing. Note that escalator demarcation lamps are not dimmable.

Use the SLA-1 or SLA-2 mounting brackets for fast installations. Order two brackets per lamp.



SL1 and VL3 Escalator Demarcation LEDs

Part Number	Description
SL1-865-3	Escalator demarcation lamp for dry/damp conditions, 18", 7.5W, white light
VL3-865-3-HB	Escalator demarcation lamp for wet conditions, 18", 12W, white light
PS24V35W-01	120/240V AC power supply for escalator LEDs
SLA-1	Adjustable mounting bracket for SL1-865-3, stainless steel, for damp areas
SLA-2	Fixed mounting bracket for SL1-865-3, stainless steel, for damp areas
SLA-3	End-mount pivot mounting bracket for SL1-865-3, stainless steel, for damp areas
VLA-5	Adjustable mounting bracket for VL3-865-3-HB, stainless steel, for wet areas
VLA-3	Fixed mounting bracket for VL3-865-3-HB, stainless steel, for wet areas
VLA-6	End-mount mounting bracket for VL3-865-3-HB, stainless steel, for wet areas

SL1 escalator demarcation LEDs are for damp conditions. VL1 escalator demarcation LEDs are for wet conditions.

Note that the mounting brackets are specified for either damp or wet environments. Order two brackets per lamp.

NOTE: Due to constant power design, input current will vary depending on input voltage. Be sure to use the correct AWG wire size for worst case input voltage.



LED Lighting Systems

i2SYSTEMS APEIRON LTE+ RECESSED LIGHTING

Apeiron LTE+ round and square dimmable LED lamps

Part Number	Description	Finish	Size and Shape
A4390Z-14CBBR	Apeiron LTE+ warm white lamp	Chrome	3 in. x 3 in. square
A4390Z-11CBBR	Apeiron LTE+ warm white lamp	Chrome	3 in. diameter round
A4390Z-11BBD	Apeiron LTE+ neutral white lamp	Chrome	3 in. diameter round
A4390Z-21CBBR	Apeiron LTE+ warm white lamp	Gold	3 in. diameter round
A4390Z-41CBBR	Apeiron LTE+ warm white lamp	Brushed nickel	3 in. diameter round
A4390Z-41BBD	Apeiron LTE+ neutral white lamp	Brushed nickel	3 in. diameter round
A4390Z-61CBBR	Apeiron LTE+ warm white lamp	Black	3 in. diameter round
A4390Z-61BBD	Apeiron LTE+ neutral white lamp	Black	3 in. diameter round
PS24V45W-E12D	Power supply with dimming		
PS24V45W-E12E	Power supply with dimming and battery backup (two lamps for 4+ hours)		

NOTE: Each power box will power up to 9 lamps.

Parts listed here are in-stock and ready to ship. Additional models and options are available.

The Apeiron LTE+ is a premium **dimnable** and cost-effective LED lighting system that outlasts similar halogen lights by a factor of 20.

The LTE+ system is literally a snap to install. The handsome lightweight lights click into position with spring clips - no screws are needed. They simply plug into the compact power box (available with an optional 4+ hour battery backup) - no wire nuts or terminals.

And unlike LED replacement bulbs, the LTE+ is designed specifically for elevators. The beam is focused for best illumination of the cab and the Color Rendering Index (CRI) is rated at 90+ for a 'true to life' light.

The Apeiron LTE+ is available in either a 3" round or 3" square size. The metal bezel is available in either chrome, gold, brushed nickel or black finishes. Dimmable power units are available with or without battery backup.

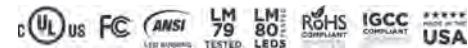

Features

- 3" round and square designs
- Available in multiple light system kits
- Emergency light operation
- Industry's best color rendering (CRI 90+)
- Light beam engineered specifically for elevators
- Simple installation - light clips in, wiring is plug and play
- Lightweight power box with dimming and optional battery backup
- cULus, RoHS, IGCC, uses LM-80 tested LEDs, LM-79 tested
- Made in the USA

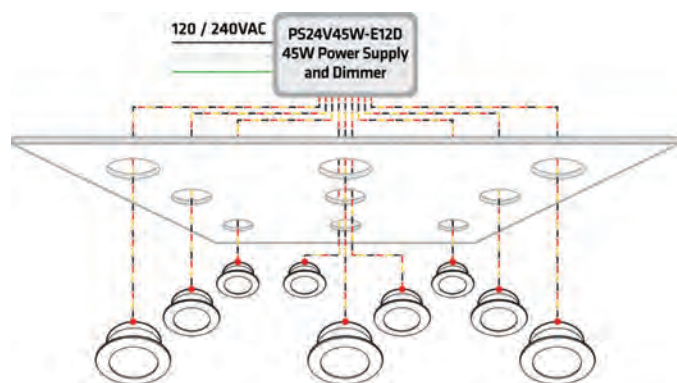

Number of Fixtures Required

Typical Capacity	Soft Light	Standard light	Bright light
2100 lbs	4	6	9
2500 lbs	4	6	9
3000 lbs	6	9	12
3500 lbs	6	9	12

Cab Ceiling

Replacement panels manufactured to strict standards to meet code compliance for elevator industry use.

S.E.E.S. #	Description
SEES-RLB-A	Cab Ceiling , replacement panel, 2 x 4, white, light diffuser for cab ceiling fluorescent type light fixture
SEES-RLB-B	Egg Crate Cab Ceiling , replacement panel, 2 x 4, brushed chrome finish, for fluorescent type light fixture

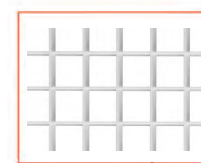

SEES-RLB-A

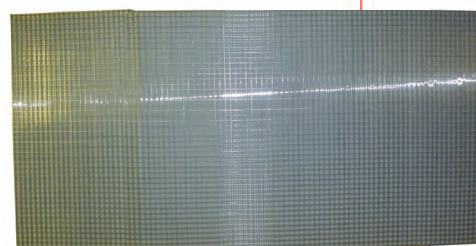

SEES-RLB-B



SEES-ILLUMINATOR-001



SEES-ILLUMINATOR-002



SEES-T8-T5-001



SEES-T5-002A



SEES-ILLUMINATOR-003



SEES-T12-T5-002

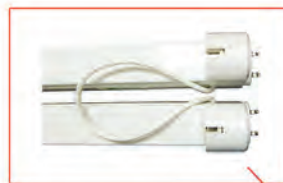

SEES-T12-T5-003



SEES-T12-T5-001



ML-151



ML-154

Cab Lighting

S.E.E.S. #	Description
SEES-ILLUMINATOR-001	LED Retrofit Kit , 110 VAC, 4' L, Soft White
SEES-ILLUMINATOR-001A	LED Retrofit Kit , 110 VAC, 4' L, Soft White with Mounting Clips
SEES-ILLUMINATOR-002	LED Retrofit Kit , 110 VAC, 4' L, Bright White
SEES-ILLUMINATOR-002A	LED Retrofit Kit , 110 VAC, 4' L, Bright White with Mounting Clips
SEES-ILLUMINATOR-003	Replacement Light Strip , LED, 110 VAC, Self Adh, Bright White
SEES-ILLUMINATOR-004	Replacement Light Strip , LED 110 VAC, Self Adh, Soft White
SEES-ILLUMINATOR-CASE	Display Case , for e-Luminator, Bright & Soft White
SEES-T5-001	Lamp , Phillips T5 Tube 25 pack
SEES-T5-002	Lamp , Halco T5 Tube 25 Pack
SEES-T5-002A	Lamp , Halco T5 Tube Sold Each
SEES-T8-T5-001	Retrofit , T8 to T5 single lamp
SEES-T12-T5-001	Retrofit , T12 to T5 Single Lamp
SEES-T12-T5-002	Retrofit , T12 to T5 1 For 2 Lamp
SEES-T12-T5-003	Retrofit , T12 to T5 2 lamps
SEES-T18-T5-001	Retrofit , T12 to T5 Single Lamp
SEES-T18-T5-002	Retrofit , T12 to T5 1 For 2 Lamp
SEES-T18-T5-003	Retrofit , T12 to T5 2 lamps
ML-151	Lamp , fluorescent green, F20T12-G
ML-152	Lamp , #1449, 14V mini screw base
ML-154	Lamp , 36" fluorescent bi-pin (esc)
ML-T8-LED-W	T8 LED Lamp , 120V 17W G13 Base 47.2" x 1.14" x 1.14"
ML-T8-48-LED	T8 LED Lamp , 36 Watt, 4 ft, 6000k-6500k, G13 Socket
ML-T8-BASE	T8 LED Lamp Holder , 120V 17W G13 Base 47.2" x 1.14" x 1.14"

Cab Lighting

S.E.E.S. #	Description
SEES-LED-001K	SEES LED HL Light Kit, Set of 4 bulbs with power supply, chrome finish
SEES-LED-002K	SEES LED HL Light Kit, Set of 4 bulbs with power supply, gold finish
SEES-LED-003K	SEES LED HL Light Kit, Set of 4 bulbs with power supply, white finish
SEES-LED-004K	SEES LED HL Light Kit, Set of 4 bulbs with power supply, black finish
SEES-LED-005K	SEES LED HL Light Kit, Set of 6 pure white with power supply, chrome
SEES-LED-001-PW	SEES LED HL LED, pure white
SEES-LED-001-PW-B	SEES LED HL LED, bulb only, pure white
SEES-LED-001-PW-F	SEES LED HL LED, fixture and socket
SEES-LED-001-DIM	SEES LED Dimmer Module, for SEES-LED-001-PW-B
SEES-LED-001-DIM-B	SEES LED Dimmer Module, with battery backup
SEES-LED-001-DIM-BK	LED Light & Dimmer Kit, with Battery Backup
ML-161-LED-W	Lamp, Elevator Cab White LED 12 VAC/DC
ML-162-LED-W	Lamp, MR16 White LED Dimmable 12 VAC/DC
ML-156	Lamp, 12V halogen reflector cab 20 watt
SEES-CLF	Cab Light Fixture, 2 x 2 LED 36W 24 VDC / 110 VAC Flatpanel
ML-159-LED-W	Lamp, White LED Bayonet bi-pin GBF, 12 VAC/DC
ML-163-LED-W	Used on Otis Cabs
ML-165-LED-W	Lamp, 28V, LED S6, White, E12 Candelabra Screw Base



SEES-LED-001K



SEES-LED-001K thru 005K



SEES-LED-005K



SEES-LED-001-PW



SEES-LED-001-PW-B



SEES-LED-001-PW-F



ML-161-LED-W



ML-162-LED-W



ML-156



SEES-LED-001-DIM



SEES-LED-001-DIM-B



ML-159-LED-W



ML-163-LED-W



ML-1090-R-NEON



ML-1090-G

Miscellaneous Lamps

S.E.E.S. #**Description****ML-1090-G****Lamp, 2187 Incandescent 28V Green with 5" Ld .65" Bezel/For Homelift****ML-1090-R-NEON****Lamp, Red 220V Neon****ML-200****Lamp, for Hall Lantern**

PIT - CAR TOP - RAILS

QUICK LOCATOR GUIDE

Alarms	435
Buffer Springs	431
Car Top Inspection Station	438-439
Chimes	434
Door Latch Assemblies	437-438
Earthquake Detection	440
Exhaust Fan Assemblies	436
Fans	436
Fire Alarms	435
Gongs	435
Guide Rails	430
Pit Flood Alarm System	428
Pit Ladders	428
Pit Sump Pumps	429
Pit Switches	429
Platform Guards	438
Safety Ripcord System	432
SEES H2O Alarm	427-428
SEES Selector	441
Seismic Sensor	440
Toe Guards	440
Top of Car Handrail System	432
Top of Car Handrail Safety Rails	433
Universal Power Supply for Emergency Lighting	440
Wire Rope Hardware	431



FEATURES

- » Imperial Motor
- » 50HL/80 starts per hour; up to two motors per tank
- » SEIM Pump
- » Maxton or EECO Valve
- » Muffler standard for removing pulsation & noise
- » Oil level detection via dip stick or sight gauge
- » Isolation between pump, motor assembly and tank
- » Grooved or threaded fittings available

Remarkably Clean:

With SEES manufacturing's unique design, your machine room will remain free of oil spills as all components are inside the tank (including the optional shut-off valve).



OPTIONAL FEATURES

- VISCOSITY TEMPERATURE SWITCH
- PRESSURE GAUGE • LOW PRESSURE SWITCH
- TANK HEATER • FULL DOWN COMPENSATION
- AIR BLADDER MUFFLER • LOAD WEIGHING SWITCH
- OIL LEVEL SIGHT GAUGE • OIL COOLER • THERMOSTAT

COLOR OPTIONS & YOUR COMPANY LOGO AVAILABLE



The SEES submersible power unit has been designed to fit through machine room doorways as small as 25" wide.



Acoustiblok soundproofing option keeps your submersible tank operating on the **QT**



Always Smooth Sailing



DAMAGE CONTROL

NEW & IMPROVED PIT FLOOD ALARM

☞ PART# SEES-H₂O-ALARM-001 {110 VAC 4" ALARM BELL WITH "SINGLE BARREL" FLOAT SWITCH GUARD}

☞ PART# SEES-H₂O-ALARM-002 {110 VAC 4" ALARM BELL WITH AUXILIARY OUTPUT CONTACT & "DOUBLE BARREL" FLOAT SWITCH GUARDS}

THE SEES H₂O ALARM FEATURES STEEL FLOAT SWITCH GUARDS TO PREVENT DAMAGE DURING INSTALLATION OR SERVICE.

"DOUBLE BARREL"
FLOAT SWITCH GUARDS



DETECT • PROTECT

- DETECT FLOODS BEFORE THEY CAUSE EXPENSIVE WATER DAMAGE.
- PROVIDES A RELIABLE EARLY WARNING SYSTEM.
- PROTECT VALUABLE EQUIPMENT FROM ALL WATER HAZARDS.

Your Elevator "Life Raft"

Always Smooth Sailing





SEES-H2O-ALARM-001
SEES-H2O-ALARM-002



S.E.E.S. #	Description
SEES-H2O-ALARM-001	SEES Pit Flood Alarm System, 110 VAC with Bell (Single Float)
SEES-H2O-ALARM-002	SEES Pit Flood Alarm System, 110 VAC with Bell & Output (Dual Floats)
SEES-H2O-ALARM-002L	SEES Pit Flood Alarm System, 110FT Long 110 VAC w/ Bell & Output
SEES-H2O-ALARM-003	Float Switch, Replacement Float Switch for H2O Alarm
SEES-H2O-ALARM-004	SEES Pit Flood Alarm System, 110 VAC with Autodialer & Output
SEES-H2O-ALARM-006	SEES Pit Flood Switch, Nema4X Encloser Stainless Float Bell & Output

Features

Detect floods before they cause expensive water damage.
Provides a reliable early warning system.
Protects Valuable Equipment from all water hazards.



Double Barrel
Switch Housing

SEES-H2O-ALARM-002



SEES-H2O-ALARM-002E

Escalator Flood Alarm

S.E.E.S. #	Description
SEES-H2O-ALARM-002E	SEES Escalator Flood Alarm System, 110 VAC with Bell and Output



MIS-WET-DRY-VAC

Dry-Vacs

S.E.E.S. #	Description
MIS-WET-DRY-VAC	Wet Dry Vac, 5 Gallon Bucket Head



SEES-PIT-LDR-001



SEES-PIT-LDR-003

Pit Ladders

S.E.E.S. #	Description
SEES-PIT-LDR-001	Pit ladder, 16" x 9' Standard Mounting
SEES-PIT-LDR-001E	Ladder Extension, 2 extension for 16" Pit Ladder
SEES-PIT-LDR-002	SEES Pit Ladder, 12" x 9' Standard Mounting
SEES-PIT-LDR-002E	Extension, for 12" Pit Ladder 2' Extension
SEES-PIT-LDR-003	SEES Pit Ladder, 9" x 9', Standard Mounting

Pit Switches

S.E.E.S. #	Description
MIS-908	Pit Switch , Run/Stop control switch, HP 125/250 VAC. Meets ANSI A17.1b Sec. 210.2E with OSHA Safety Lockout on switch guard. The best on the market!
MIS-909	Pit Switch , Labeled UL/CSA model for code requirements.
SEES-PIT-LT-001	Pit Light Pack , Light with Cage, GFCI Outlet, and Rocker Switch
SEES-PIT-LT-002	Pit Light Pack , Light/Cage, GFCI Outlet, Run/Stop Rocker Switch for Light
SEES-PIT-SW-001	Pit Light Pack , Push-to-Stop Pull-to-Run, Standard Encl, 1 N.O./1 N.C.
SEES-PIT-SW-001N	Pit Switch , Push-to-Stop Pull-to-Run, NEMA4X
SEES-PIT-SW-002	Pit Switch , Push-to-Stop Pull-to-Run, Standard Encl, 2 N.C.
SEES-PIT-SW-002N	Pit Switch , Push-to-Stop Pull-to-Run, NEMA4X, 2 N.C.



MIS-908



MIS-909



SEES-PIT-LT-002



SEES-PIT-SW-002

Pit Sumps

S.E.E.S. #	Description
SEES-SUMP-001	SEES Sump Pump , 1/3HP Submersible with Float
SEES-SUMP-002	SEES Sump Pump , 1/2HP Submersible with Float
MIS-913*	Sump Switch , solid state switch, water/no oil, 120 VAC

*Meets ASME A17.1, 2.2.2.5 requirements



SEES-SUMP-002



MIS-913

Guide Rails

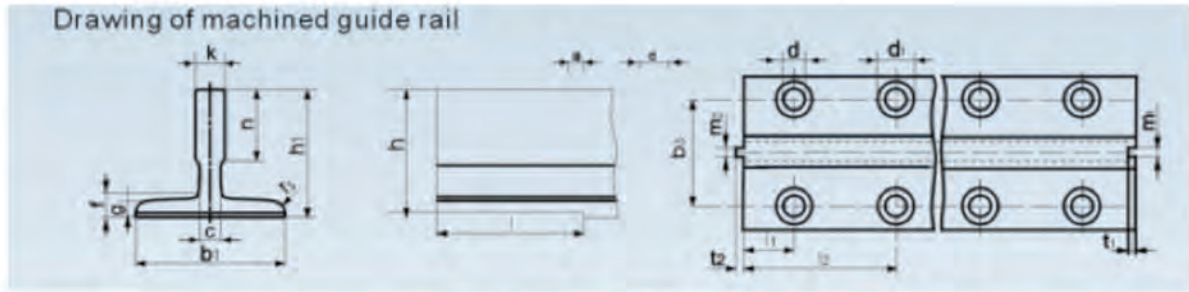

	b1	h1	h	k	n	c	g	f	rs	m1	m2	t1	t2	l	l1	l2	b3	d
T70-1/B	2.75	2.52	2.56	0.354	1.34	0.236	0.236	0.314	0.05	0.118	0.116	0.138	0.12	5.04	0.98	4.13	1.654	0.5118
T89/B	3.50	2.44	2.402	0.625	1.31	0.375	0.313	0.438	0.11	0.252	0.251	0.281	0.25	6.14	1.50	4.50	2.250	0.5625
T127-2/B	5.00	3.50	3.465	0.625	2.01	0.375	0.500	0.625	0.20	0.252	0.251	0.281	0.25	6.14	1.50	4.50	3.125	0.6875

Dimensions are inches

Guide Rails

S.E.E.S. #	Description
SEES-GR-T50-2.5M	Guide Rail , 3.75 LB/FT Machined Guide Rail, 2.5M
SEES-GR-T50-CLIP	Guide Rail Clip , 3.75 LB/FT Machined Guide Rail Forged Clip, 5/8" I.D.
SEES-GR-T50-FP	Fishplate , 3.75 LB/FT Machined Guide Rail Fishplate
SEES-GR-T89-8	Guide Rail , 8.25 LB/FT Machined Guide Rail 8' Length
SEES-GR-T89-10	Guide Rail , 8.25 LB/FT Machined Guide Rail 10' Length
SEES-GR-T89-16	Guide Rail , 8.25 LB/FT Machined Guide Rail 16' Length
SEES-GR-T89-CLIP	Guide Rail Clip , 8.25 LB/FT Guide Rail Clips, 5/8" I.D.
SEES-GR-T89-FP	Fishplate , 8.25 LB/FT Guide Rail Fishplate
SEES-GR-T89-FP-BN	Fishplate Hardware , 8.25 LB/FT Guide Rail Fishplate Hardware, 8 Nuts & Bolts
SEES-GR-T127-8	Guide Rail , 15.125 LB/FT Machined Guide Rail 8' Length
SEES-GR-T127-16	Guide Rail , 15.125 LB/FT Machined Guide Rail 16' Length
SEES-GR-T127-CLIP	Guide Rail Clip , 15.125 LB/FT Guide Rail Clips, 5/8" I.D.
SEES-GR-T127-FP	Fishplate , 15.125 LB/FT Guide Rail Fishplate
SEES-GR-T127-FP-BN	Fishplate Hardware , 15.125 LB/FT Guide Rail Fishplate Hdw, 8 Nuts & Bolts
SEES-GR-T127-FP-LP	Guide Rail Fishplate , 15.125LB/FT, Low Profile
SEES-GR-T127-FP-HD	Guide Rail Fishplate , 15.125LB/FT, Heavy Duty XXH threaded
SEES-GR-T70-8	Guide Rail , 6 LB/FT Machined Guide Rail 8' Length
SEES-GR-T70-FP	Fishplate , 6 LB/FT Machined Guide rail Fishplate
SEES-GRB-001	Guide Rail Bracket , adjustable 2-7/16" to 6-7/16" for 12 & 15 LB
SEES-GRB-001E	Guide Rail Extension Bracket , for SEES-GRB-001
SEES-GRB-002	Guide Rail Bracket , adjustable 2-1/8" to 4-1/8" for 15 LB
SEES-GRB-003	Guide Rail Bracket , 1/4" x 3" 90deg Mntg Bracket, Slotted Holes
SEES-GRC-001	Guide Rail Clip , with nut and bolt, for 12 LB and 15 LB, 5/8" I.D.
SEES-GRC-002	Guide Rail Clip , with nut and bolt, for 8 LB, 5/8" I.D.



SEES-GRB-001



SEES-GRB-001E



SEES-GR-T127-CLIP



SEES-GRC-001



SEES-GRB-002



SEES-GRB-003

Buffer Springs

S.E.E.S. #	Description
SEES-BS-8500	Buffer Spring , 18.50" x 4.75" O.D. x 2.75" I.D. 1" Steel Wire 14 Turns, 8,500 lb capacity
SEES-BS-10000	Buffer Spring , 18.50" x 4.75" O.D. x 2.75" I.D. 1" Steel 13.75 Turns, 10K lb capacity
SEES-BSS-8642	Buffer Spring Stand , for 8642 Spring
SEES-OBSW-001	Oil Buffer Switch , Universal 1 N.O./1 N.C.



SEES-BS-8500

Pit Products

Wire Rope Hardware

S.E.E.S. #	Description
MIS-WR-102	Wedge Insert , 1/2" for rope diameter 1/2"
MIS-WR-103	Wedge Insert , 5/8" for rope diameter 5/8"
MIS-WR-104	Retainer Clamp , 1/4" and 5/8" for rope diameter 1/4" and 3/8". 2 per assembly
MIS-WR-105	Retainer Clamp for rope diameter 1/2", 9/16" & 5/8" 2 per assembly
MIS-WR-106	Wedge Guard for 3/8" cable
MIS-WR-107	Wedge Guard for 1/2" and 5/8" cable
MIS-WR-108	Seizing Bands , 5/8", Box of 50 for 5/8" wire rope
MIS-WR-109	Seizing Bands , 1/2", Box of 50 for 1/2" wire rope
MIS-WR-110	Seizing Bands , 3/8", Box 50 for 3/8" wire rope



MIS-WR-103



MIS-WR-104



MIS-WR-106



MIS-WR-107



MIS-WR-108



MIS-WR-110

Safety Ripcord System

S.E.E.S. #	Description
SEES-RIPCORDER-001	Safety Ripcord, Pit Kit
SEES-RIPCORDER-002	Safety Ripcord, TOC Kit

Contact SEES for more information on this life saving safety system.

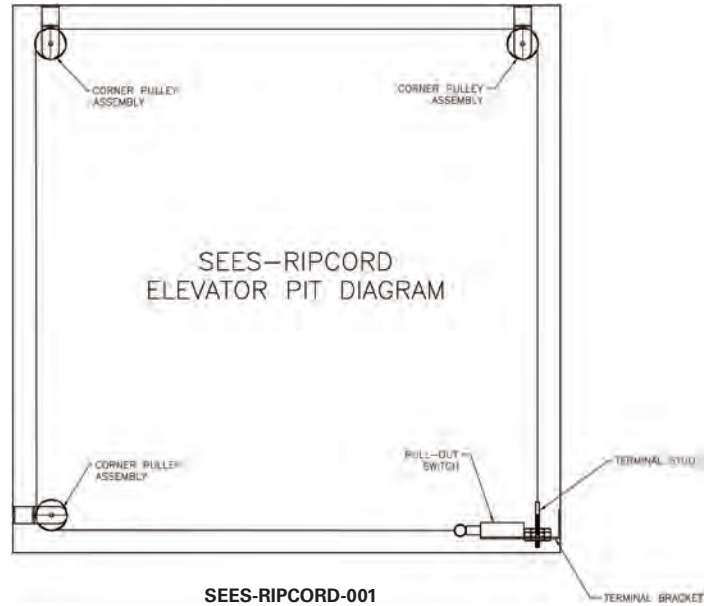

Car Tops

The SEES-TOCH (Top of Car Handrail) system is a fully adjustable, light weight design that will fit existing and new cab installations. The SEES-TOCH is constructed of durable 6061 extruded aluminum square tubing 1/8" thick for superior performance and resistance to corrosion. Each kit comes with all necessary hardware and kick plate for ease of installation. It can be mounted to existing canopy or adapted with uni-strut (not provided.) The SEES-TOCH is designed to meet ASME Code A17.1A, 2.10.2 & 2.14.1.7. Each package can be shipped via UPS or FedEx. Custom sizes are available upon request.



Top of Car Handrail

S.E.E.S. #	O.E.M. #	Description
SEES-TOCH-001	18-400	Front Opening 66"-96" W x 46"-70" D
SEES-TOCH-002	18-410	Front Opening 46"-70" W x 66"-110" D
SEES-TOCH-003	18-440	Front Opening 66"-96" W x 66"-96" D
SEES-TOCH-004	18-430	Front & Rear Opening Up to 96" W x 46"-70" D
SEES-TOCH-005	18-420	Front & Rear Opening Up to 72" W x 66"-110" D
SEES-DRKP-001		SEES Door Reinforcing Kickplate, 16GA 304SS

Top of Car Safety Rails

TOC KITS / CONFORMS TO ASME 17.1 SPECIFICATIONS

BIG-TOC and LIL-TOC Top Of Car safety rails

Part Number	Toe-board Part Number	Description	Opening	Size Range (min > max) Width (in • m)	Depth (in • m)	Weight lbs • kg
100-01	100-01TB	LIL-TOC	front	57 > 82 • 1.45 > 2.08	57 > 82 • 1.45 > 2.08	148 • 67.2
100-01 / 100-20		LIL-TOC w/ two-sided extension kit	front	57 > 82 • 1.45 > 2.08	99 > 123 • 2.51 > 3.12	183 • 83.2
100-01 / 100-19		LIL-TOC w/ three-sided extension kit	front	99 > 123 • 2.51 > 3.12	99 > 123 • 2.51 > 3.12	200 • 90.9
100-03	100-03TB	BIG-TOC 60	front	69 > 118 • 1.75 > 3.00	69 > 118 • 1.75 > 3.00	184 • 83.6
100-03 / 100-20		BIG-TOC 60 w/ two-sided extension kit	front	69 > 118 • 1.75 > 3.00	123 > 159 • 3.12 > 4.04	219 • 99.5
100-03 / 100-19		BIG-TOC 60 w/ three-sided extension kit	front	123 > 159 • 3.12 > 4.04	123 > 159 • 3.12 > 4.04	236 • 107.3
100-05	100-05TB	BIG-TOC 72	front	69 > 118 • 1.75 > 3.00	81 > 130 • 2.06 > 3.30	192 • 87.3
100-05 / 100-20		BIG-TOC 72 w/ two-sided extension kit	front	69 > 118 • 1.75 > 3.00	135 > 171 • 3.43 > 4.34	227 • 103.2
100-05 / 100-19		BIG-TOC 72 w/ three-sided extension kit	front	123 > 159 • 3.12 > 4.04	135 > 171 • 3.43 > 4.34	244 • 110.9
100-13	100-13TB	LIL-TOC	front	45 > 70 • 1.14 > 1.78	69 > 106 • 1.75 > 2.69	158 • 71.8
100-15	100-15TB	LIL-TOC	front	57 > 82 • 1.45 > 2.08	69 > 106 • 1.75 > 2.69	162 • 73.6
100-17	100-17TB	LIL-TOC	front	57 > 82 • 1.45 > 2.08	45 > 70 • 1.14 > 1.78	141 • 64.1
100-13 / 100-20		LIL-TOC w/ two-sided extension kit	front	45 > 70 • 1.14 > 1.78	123 > 147 • 3.12 > 3.73	193 • 87.7
100-15 / 100-20		LIL-TOC w/ two-sided extension kit	front	57 > 82 • 1.45 > 2.08	123 > 147 • 3.12 > 3.73	197 • 89.5
100-17 / 100-20		LIL-TOC w/ two-sided extension kit	front	57 > 82 • 1.45 > 2.08	99 > 111 • 2.51 > 2.89	176 • 80.0
100-13 / 100-19		LIL-TOC w/ three-sided extension kit	front	99 > 111 • 2.51 > 2.89	123 > 147 • 3.12 > 3.73	210 • 95.5
100-15 / 100-19		LIL-TOC w/ three-sided extension kit	front	99 > 123 • 2.51 > 3.12	123 > 147 • 3.12 > 3.73	214 • 97.3
100-17 / 100-19		LIL-TOC w/ three-sided extension kit	front	99 > 123 • 2.51 > 3.12	99 > 111 • 2.51 > 2.89	193 • 87.7
100-07	100-07TB	LIL-TOC F&R	front and rear	n/a	57 > 82 • 1.45 > 2.08	116 • 52.7
100-09	100-09TB	BIG-TOC 60 F&R	front and rear	n/a	69 > 118 • 1.75 > 3.00	142 • 64.5
100-11	100-11TB	BIG-TOC 72 F&R	front and rear	n/a	81 > 130 • 2.06 > 3.30	149 • 67.7
100-07 / 100-20		LIL-TOC F&R w/ two-sided extension kit	front and rear	n/a	99 > 123 • 2.51 > 3.12	151 • 68.6
100-09 / 100-20		BIG-TOC 60 F&R w/ two-sided extension kit	front and rear	n/a	123 > 159 • 3.12 > 4.04	177 • 80.5
100-11 / 100-20		BIG-TOC 72 F&R w/ two-sided extension kit	front and rear	n/a	135 > 171 • 3.43 > 4.34	184 • 83.6

BIG-TOC and LIL-TOC (Top Of Car) safety rail kits install on top of freight and passenger traction elevators to create a safer and more secure car-top environment for both people and their tools. These permanent guardrail kits are easy to install and quickly adjust to the required size. They are adaptable to both front-opening and front-and-rear opening car types. All rails, bolts, nuts and hardware are included. The major siderail components come pre-assembled. Installation generally takes under an hour. The toe board is ordered separately and serves as an added measure to prevent the loss of tools and other important items.

Determining width and depth requirements for your TOC safety rail kit:

Width – The distance between the roller guide plates determines width, because the TOC side rails mount inside the roller guide plates.

Depth – Measure the inside car depth.

Height – Height is adjustable and is measured from the top of the car to the top handrail of the installed TOC safety rail kit.

NOTE: If clearance between the top of the car and the bottom of the crosshead is less than 18", please call for assistance.

All listed toe boards are 4" height; 5" height available upon request.

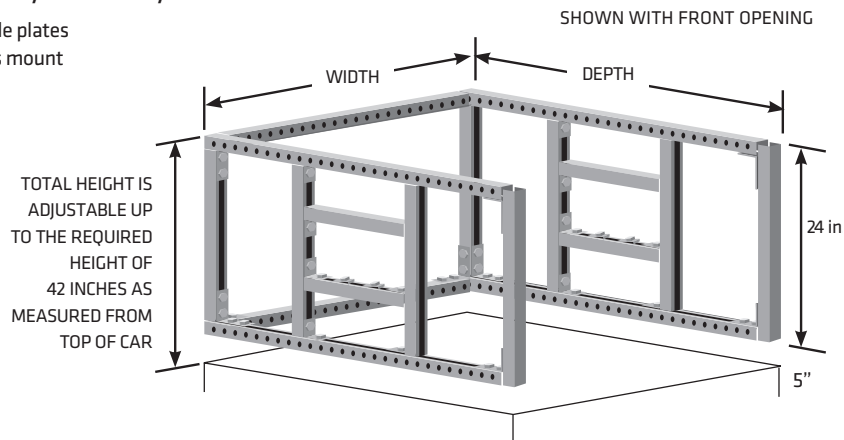

Bells and Alarms

Electronic Chimes



S.E.E.S. #	Description
MIS-CH1	Chime , universal replacement for most chimes, 24 - 130 VAC or VDC, non-polar negative common, 3-wire hook-up, chimes 1 up, 2 down, 4" x 2-1/2" x 1"
MIS-CH7	Floor Passing Chime , multi-volt 24 - 120V
MIS-CH9	Chime , Sonalert, 60/250V VAC or VDC SC250D
CYB-381	Audio alert device , 4-28 VDC
CYB-382-S	Audio alert device , 3-20 VDC
CYB-382-SB	Bracket , Mounting for Audio Alert Device
CYB-50	Audio alert device , 70-150 VDC



MIS-CH1



MIS-CH7



MIS-CH9



CYB-382-S



CYB-382-SB



CYB-50

Bells and Alarms

Fire Alarms

S.E.E.S. #	O.E.M. #	Description
MIS-250	9120B	Smoke Alarm , Wire-In Type Smoke Alarm, Dual Ionization, Power 120 VAC at 60Hz with 9V battery back-up
MIS-250A	RM4	Relay , Relay module, 120 VAC, for MIS-250



MIS-250



MIS-250A

Alarm Bells

Easy to install, alarm bells have a strong, simplified mechanical construction which requires less maintenance time. Rugged construction with rust-protected finish provide reliable performance for both indoor and outdoor use.

S.E.E.S. #	Description
MIS-125D	Alarm Bell , 12 VDC, 6" diameter
MIS-125E	Alarm Bell , 120 VAC, 6" diameter
MIS-125F	Alarm Bell , "Flashing" type, 120 VAC, 6" diameter, with flashing red light
MIS-125M	Alarm Bell , 6" 12 VDC Nylube 92db .15 mA
MIS-125N	Alarm Bell , 6" 6 VDC Nylube 92db .15 mA
MIS-125Q	Alarm Bell , 6" 6 VDC 92db .15 ma black Bell
1000-02-10EPCO	Alarm Bell , 12V bell, 6
1000-03-10EPCO	Alarm Bell , 6V bell, 6
1000-04-10EPCO	Alarm Bell , 24V bell, 6



MIS-125M



MIS-125Q



1000-03-10



1000-04-10

Gongs

S.E.E.S. #	Description
MIS-125	Brass Gong , 2-1/2" diameter, single stroke, 115 VAC
MIS-125A	Brass Gong , 2-1/2" diameter, single stroke, 40 Watt Series
MIS-125B	Brass Gong , 2-1/2" diameter, single stroke, 25 Watt Series
MIS-125-48VDC	Brass Gong , 2-1/2" diameter, single stroke, 48 VDC

■ See also Car Signal Components listed by elevator manufacturer for additional gongs.



MIS-125



MIS-901



MIS-901AM



MIS-901A



MIS-901G



MIS-901R



MIS-197



MIS-197A



MIS-901B



MIS-902



MIS-901H



MIS-901J



MIS-903



MIS-904

Fans

S.E.E.S. #	O.E.M. #	Description
MIS-901		Exhaust Fan , 2 speed, round, 120V, 10" O.D. Fan motors are sealed, self lubricating and rubber mounted to housing for quiet dependable service.
MIS-901A		Exhaust Fan , one or two speed exhaust fan 10" Square
MIS-901B		Exhaust Fan , 2 speed, round, Low Profile 12" D 5" deep for cab
MIS-901C		Exhaust Fan , Two speed with adaptor (up to 15")
MIS-901E		Exhaust Fan , 3 Speed Enclosed For High speed Elev 400CFM Flow
MIS-901F		Exhaust Fan , Dual 3 Spd 120 VAC High Spd Elev 800CFM Air Flow
MIS-901G	XF12VDC	Exhaust Fan , 12V Emergency Backup Operates At 80 Degrees On 6 VDC
MIS-901H	NYPS-4	Power Supply , Emergency Exh 2hrs Of Power, Used with MIS-901G
MIS-901J	NYPS-8	Power Supply , Emergency Exh 4hrs Of Power, Used with MIS-901G
MIS-901AM		Motor , replacement fan for MIS-901A
MIS-901R	9853194	Fan , Rotron fan rack mount 5.22" H 19" W x 13.70" Deep
MIS-902		Adapter for exhaust fan. Allows installation of todays high performance fan models to replace older, larger diameter units. Adapter plate measures 15" sq. with 10" diameter mounting hole.
MIS-903		Grill for exhaust fan. White enamel 14" O.D. for MIS-900 or MIS-901 fans. Heavy duty welded steel.
MIS-904		Grill for exhaust fan. Chrome - #4 stainless steel 14" O.D. for MIS-901 fans. Heavy duty welded steel delivers high performance with low air flow restriction.

Emergency Ceiling Exit Switches

S.E.E.S. #	O.E.M. #	Description
MIS-197		Ceiling Emergency Latch Switch , DPDT Switch allows for building security circuit to be notified, as well as separate circuit for car shut down or, as code requires. Requires manual latch reset from car top.
MIS-197A	AAA6098NS1	Top of Car Exit , contact kit, plug type
MIS-197B	USP18576	Emergency Ceiling Exit , Switch Assembly, Car Top Escape
MIS-197C	9768547	Emergency Ceiling Exit , Switch Assembly, ThyssenKrupp
MIS-197D	6993C64G03	Emergency Ceiling Exit , Switch Assembly, Westinghouse
MIS-197E	321C984G01	Emergency Ceiling Exit , Switch Kit, Westinghouse



MIS-197B



MIS-197C

Electric Door Latch Assembly

S.E.E.S. #	O.E.M. #	Description
MIS-914A	A835A3	Electric Door Restrictor Hatch Latch Assembly
MIS-194-AB	A835BT	Battery, 12 V 2.9 AMP HR.
MIS-914B	A835PL	Plunger, Replacement for MIS-914A
MIS-914C	A835PC4	PCB, Hatch Latch, replacement for MIS-914A
MIS-914D	636101	Door Restrictor, Electronic Door Restrictor, Safe Exit
MIS-914F	A835PH	PhotoEye, with bracket and 9ft cable for Hatch Latch
MIS-914G	A835SYSBK	Solenoid, with 9ft cable and bracket for Hatch Latch
MIS-914H	A835S1	Solenoid, with 9ft cable and bracket for Hatch Latch
MIS-914I	A835SBA3	Solenoid Mounting Bracket, for Hatch Latch
MIS-914J	A835ZC	Solenoid Plunger Bracket, Z-bracket for Hatch Latch
MIS-914-T		Reflective Targets, Alum Plate with 4" x 18" Reflective Tape
MIS-914L	A835RA	Reflective Angle, for Hatch Latch
MIS-914M	A835BB	Bracket, stop 7GA 5" x 10" for Hatch Latch
MIS-914N	A835OPTO	Door Open Pilot, OPTO Module for Hatch Latch
MIS-914-TAPE		Reflective Tape, 2" wide roll of 10 ft



MIS-914A



MIS-194-AB



MIS-914D



MIS-914B

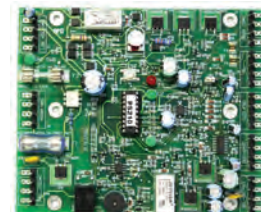

MIS-914C



MIS-914F



MIS-914-TAPE



MIS-914M



MIS-914-BK-2SLH



MIS-914-BK-2SRH



MIS-914-PCB



MIS-916



PEND-3B



PEND-3B-LEG



SEES-TOCI-001

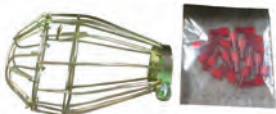

Electric Door Latch Assembly

S.E.E.S. #	O.E.M. #	Description
MIS-914A	A835A3	Electric Door Restrictor Latch Assembly , Hatch
MIS-914B	A835PL	Plunger , Replacement for MIS-914A
MIS-914C	A835PC4	PCB , Hatch Latch, replacement for MIS-914A
MIS-914D	636101	Door Restrictor , Electronic Door Restrictor, Safe Exit
MIS-914E	A835MC	Money Clip , for hatch latch for MIS-914A
MIS-914F	A835PH	PhotoEye , with bracket and 9ft cable for Hatch Latch
MIS-914G	A835SYSBK	Solenoid , with 9ft cable and bracket for Hatch Latch
MIS-914H	A835S1	Solenoid , with 9ft cable and bracket for Hatch Latch
MIS-914I	A835SBA3	Solenoid Mounting Bracket , for Hatch Latch
MIS-914J	A835ZC	Solenoid Plunger Bracket , Z-bracket for Hatch Latch
MIS-914L	A835RA	Reflective Angle , for Hatch Latch
MIS-914M	A835BB	Bracket , stop 7GA 5" x 10" for Hatch Latch
MIS-914N	A835OPTO	Door Open Pilot , OPTO Module for Hatch Latch
MIS-914BK		Stop Bracket , for MIS-914 with hardware
MIS-914-BK-2SLH		Stop Bracket , for MIS-914 2SP, L.H. with Hardware
MIS-914-BK-2SRH		Stop Bracket , for MIS-914 2SP, R.H. with Hardware
MIS-914PE		Photo Eye , replacement with cable
MIS-914PS		Plunger Solenoid Assembly , with cable
MIS-914M	A835BB	Bracket , stop 7GA 5" x 10" for hatchlatch
MIS-914-BAT		Battery , 12V, 2.5AH replacement for MIS-914
MIS-914-PEK		Photo Eye Kit , with sensor cable, bracket and tape
MIS-914-POW		Rear Door Kit , for SEES Electro-Strictor
MIS-914-SOL		Plunger Solenoid Assembly , only no cable
MIS-914-TAPE		Reflective Tape , 2" wide roll of 10 ft
MIS-914-PCB		PCB Replacement , for MIS-914
MIS-915	9894433	Tool , Taper pin extractor
MIS-916		Power Supply , Universal, #OTIS50E-EE
MIS-917		Power Supply , Bench, 3 Outputs
MIS-918		Power Supply , 220 VAC

Pendant Station Parts

S.E.E.S. #	O.E.M. #	Description
PEND-3B	M1-300-309	Control 3 Button , Start, Stop, Enable
PEND-3B-LEG	D7-18BE165	Legend , 50mm, Black, Off/On

Car Top Inspection

S.E.E.S. #	O.E.M. #	Description
SEES-TOCI-001	TCIG-A	Top of Car Inspection Station , 6V Bell 120V Fire LED/Buzzer, GFCI, Lamp & Guard
SEES-TOCI-001A	TCIG-A24	Top of Car Inspection Station , 6V Bell 24V Fire LED/Buzzer, GFCI, Lamp & Guard
SEES-TOCI-002	TCIG-A120	Top of Car Inspection Station , 120V Bell 120V Fire LED/Buzzer, GFCI, Lamp & Guard
SEES-TOCI-002A		Top of Car Inspection Station , 120V Bell 24V Fire LED/Buzzer, GFCI, Lamp & Guard
SEES-TOCI-003		Top of Car Inspection Station , 12V Bell 120V Fire LED/Buzzer, GFCI, Lamp & Guard
SEES-TOCI-003A		Top of Car Inspection Station , 12V Bell 24V Fire LED/Buzzer, GFCI, Lamp & Guard

Car Top Inspection

S.E.E.S. #	Description
MIS-910A	Inspection Station, Car Top 6V with Alarm Bell, GFCI & Lamp Guard
MIS-910B	Inspection Station, 12V Alarm GFCI & Metal Lmp Guard, CSA
MIS-910C	Inspection Station, 24V Alarm GFCI & Metal Lmp Guard, CSA
MIS-910D	Inspection Station, 120V Alarm GFCI & Metal Lmp Guard, CSA
MIS-911B	Inspection Station, for Car Bo GFCI
MIS-147	Lamp Guard, metal clamp on guard for Car Top Inspection Station
MIS-147A	Lamp Guard, for Car Top Inspection ION/Plastic, 109789



MIS-147

S.E.E.S. #	O.E.M. #	Description
TCTI-001	9890531	Thyssen Car Top Inspection Station

S.E.E.S. #	Description
SEES-TOCH-001A	TOCH, 6Front Opening 45"-70" W x 35"-50" D
SEES-TOCI-001-FLK	Top of Car Inspection Station, Kit 6V Bell 120V Fire LED/Buzzer, GFCI, Lamp & Guard, Flex Light Bulb
SEES-TOCI-001A	Top of Car Inspection Station, 6V Bell 24V Fire LED/Buzzer, GFCI, Lamp & Guard
SEES-TOCI-001A-FLK	Top of Car Inspection Station, Kit 6V Bell 24V Fire LED/Buzzer, GFCI, Lamp & Guard, FLex Light & Bulb
SEES-TOCI-002	Top of Car Inspection Station, 120V Bell 120V Fire LED/Buzzer, GFCI, Lamp & Guard
SEES-TOCI-002-FLK	Top of Car Inspection Station, Kit 120V Bell 120V Fire LED/Buzzer, GFCI, Lamp & Guard, Flex Light&Bulb
SEES-TOCI-002A	Top of Car Inspection Station, 120V Bell 24V Fire LED/Buzzer, GFCI, Lamp & Guard
SEES-TOCI-002A-FLK	Top of Car Inspection Station, Kit 120V Bell 24V Fire LED/Buzzer, GFCI, Lamp & Guard, Flex Light & Bulb
SEES-TOCI-003	Top of Car Inspection Station, 12V Bell 120V Fire LED/Buzzer, GFCI, Lamp & Guard
SEES-TOCI-003-FLK	Top of Car Inspection Station, Kit 12V Bell 120V Fire LED/Buzzer, GFCI, Lamp & Guard, Flex Light & Bulb
SEES-TOCI-003A	Top of Car Inspection Station, 12V Bell 24V Fire LED/Buzzer, GFCI, Lamp & Guard
SEES-TOCI-003A-FLK	Top of Car Inspection Station, 12V Bell 24V Fire LED/Buzzer, GFCI, Lamp & Guard, Flex Light & Bulb
MIS-147B-P	Car Top Light, magnetic base with flex neck & 25ft cord with plug
MIS-147B	Car Top Light, magnetic base with flex neck & 25ft cord



MIS-147A



TOCI-LF

S.E.E.S. #	Description
TOCI-L	Top of Car Inspection Box, with GFCI receptacle and light fixture/cage
TOCI-LF	Top of Car Inspection Box, with GFCI receptacle, light fixture/cage and fire service light/buzzer indicators
TOCI-LA	Top of Car Inspection Box with GFCI receptacle, light fixture/cage and audible 6 - 28 VDC alarm
TOCI-LFA	Top of Car Inspection Box with GFCI receptacle, light fixture/cage, fire service light/buzzer indicators



SEES-TLS-001

SEES Terminal Limit Switch

S.E.E.S. #	Description
SEES-TLS-001	SEES Terminal Limit Switch Assembly, Universal
SEES-TLS-002	SEES Terminal Limit Switch Assy, Universal (14 Switches)



EPP-001



EPP-001A



EFP-120C



EFP-120B



SEES-EQM-001

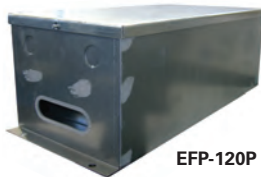

EFP-120P



MIS-630



MIS-631

 SEES-PTG-36-036
TO
SEES-PTG-36-048

Universal Power Supply for Emergency Lighting

S.E.E.S. #	O.E.M. #	Description
EPP-001	1000-02-01	Power Supply , 12V power pack
EPP-002	1000-02-02	Power Supply , 12V power pack with light fixture
EPP-003	1000-02-03	Power Supply , 12V power pack with bell
EPP-004	1000-02-04	Power Supply , 12V power pack with light fixture, bell & GFI
EPP-001A	1000-03-01	Power Supply , 6V power pack
EPP-002A	1000-03-02	Power Supply , 6V power pack with light fixture
EPP-003A	1000-03-03	Power Supply , 6V power pack with bell
EPP-004A	1000-03-04	Power Supply , 6V power pack with light fixture, bell & GFI
6V-GB	6V GB	Gell Board , 6V Power supply
6V-GB-KIT		Kit , PCB and Battery for 6V Gell Pack
6V-GB-PCB		PCB , Replacement for 6V Gell Pack
12V-GB	12V GB	Gell Board , 12V Power supply
12V-GB-KIT		Kit , PCB and Battery for 12V Gell Pack
12V-GB-PCB		PCB , Replacement for 12V Gell Pack
EFP-120B	EFP-120B	Flexlite , PC Board
EFP-120C	EFP-120C	Flexlite , Charger unit
EFP-120P	EFP-120P	Flexlite , Power pack
MIS-194G		Battery , 6V battery used in power packs, 2 in 12V

Earthquake Detection

S.E.E.S. #	O.E.M. #	Description
SEES-EQM-001	EQ-PQM3000	SEES , Earthquake monitor
MIS-630		Electronic Seismic Sensor / Amp Assembly
MIS-194AC		Battery , 6 VDC, for Draka, Seismic Sensor
MIS-631	SS04E	Seismic Elevator Switch , Loadtech for elevator and escalator protection

Platform Guards / Toe Guards

S.E.E.S. #	Description
SEES-PTG-36-036	Guard , Platform / Toe / Apron for 36" opening, Actual 38" x 36"
SEES-PTG-36-038	Guard , Platform / Toe / Apron for 36" opening, Actual 38" x 38"
SEES-PTG-36-040	Guard , Platform / Toe / Apron for 36" opening, Actual 38" x 40"
SEES-PTG-36-042	Guard , Platform / Toe / Apron for 36" opening, Actual 38" x 42"
SEES-PTG-36-044	Guard , Platform / Toe / Apron for 36" opening, Actual 38" x 44"
SEES-PTG-36-046	Guard , Platform / Toe / Apron for 36" opening, Actual 38" x 46"
SEES-PTG-36-048	Guard , Platform / Toe / Apron for 36" opening, Actual 38" x 48"
SEES-PTG-42-036	Guard , Platform / Toe / Apron for 42" opening, Actual 44" x 36"
SEES-PTG-42-038	Guard , Platform / Toe / Apron for 42" opening, Actual 44" x 38"
SEES-PTG-42-040	Guard , Platform / Toe / Apron for 42" opening, Actual 44" x 40"
SEES-PTG-42-042	Guard , Platform / Toe / Apron for 42" opening, Actual 44" x 42"
SEES-PTG-42-044	Guard , Platform / Toe / Apron for 42" opening, Actual 44" x 44"
SEES-PTG-42-046	Guard , Platform / Toe / Apron for 42" opening, Actual 44" x 46"
SEES-PTG-42-048	Guard , Platform / Toe / Apron for 42" opening, Actual 44" x 48"
SEES-PTG-48-030	Guard , Platform / Toe / Apron for 48" opening, Actual 50" x 30"
SEES-PTG-48-036	Guard , Platform / Toe / Apron for 48" opening, Actual 50" x 36"
SEES-PTG-48-038	Guard , Platform / Toe / Apron for 48" opening, Actual 50" x 38"
SEES-PTG-48-040	Guard , Platform / Toe / Apron for 48" opening, Actual 50" x 40"
SEES-PTG-48-042	Guard , Platform / Toe / Apron for 48" opening, Actual 50" x 42"
SEES-PTG-48-044	Guard , Platform / Toe / Apron for 48" opening, Actual 50" x 44"
SEES-PTG-48-046	Guard , Platform / Toe / Apron for 48" opening, Actual 50" x 46"
SEES-PTG-48-048	Guard , Platform / Toe / Apron for 48" opening, Actual 50" x 48"
SEES-PTG-STRUT	Strut , for Toe Guard

SEES Selector

S.E.E.S. #	O.E.M. #	Description
SEES-SELECTOR-001	IP READER	Selector, Assembly
SEES-SELECTOR-001-PCB		Selector Replacement PCB
SEES-SELECTOR-003	IP MOUNTING KIT	Selector, Mounting Kit
SEES-SELECTOR-MAG-001	IP8300-LSM-DZ	Selector, Door Zone Magnet 1 Per Floor
SEES-SELECTOR-MAG-001K	IP8300-LSM-KIT	Selector, Door Zone Magnet 1 Per Elevator
SEES-SELECTOR-TAPE-001		SEES Selector Tape, 3"
SEES-SELECTOR-TG-001		SEES Selector Tape Guide, 3 hole with thumbscrew
STG-001		Tape Guide, CEC-Swift
ES-001	9745312	Vane Magnetic Selector Tape, ELGO Selectors, Absolute Positioning for Dover/Thyssen



SEES-SELECTOR-001

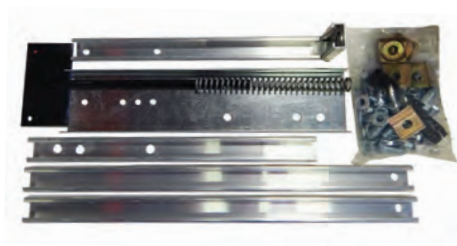

SEES-SELECTOR-003



SEES-SELECTOR-MAG-001



SEES-SELECTOR-TAPE-001

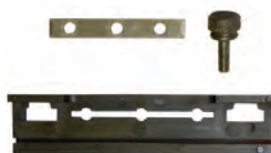

SEES-SELECTOR-TG-001



STG-001



BARRICADE SALE!



- ✓ LIGHT AND PORTABLE
- ✓ PREVENTS ACCIDENTS
- ✓ EASY TO USE AND CLEAN
- ✓ RUGGED CONSTRUCTION

 **CALL NOW: 800.526.0026**

UNBEATABLE SAVINGS!

BARR-001A

36" W X 42" H panel, 10mm thick

~~LIST: \$28~~
SALE PRICE: \$22



BARR-003

(3) 36" W x 42" H panels, 10mm thick, with anchors and (2) locks

~~LIST: \$140~~
SALE PRICE: \$110



BARR-004

(4) 36" W x 42" H panels, 10mm thick, with anchors and (3) locks

~~LIST: \$175~~
SALE PRICE: \$140



SAFETY

QUICK LOCATOR GUIDE

Personal Protection Equipment	444
Barricades	448
Duffle Bag	446
Earplugs	445
First Aid Kits	445
Floor Decals	448
Galvanized Cable	445
Glasses, Goggles	444-445
Gloves	445
Ground Fault Protection	449
Hard Hats	446
Harness	445
Jumper Kits	449
Knee Pads	446
Lockout Tags	446
Markers, Caution Tape	445
Masks	444
Pads, Oil Absorbent	445
Respirators	445
SAFE KIT	445
SEES Barracada	449
Vests	446

Personal Protection Equipment



SEES-MASK-001



SEES-MASK-001-20P



SEES-MASK-009



SEES-MASK-010



SEES-MASK-011



SEES-PPE-003



SEES-PPE-004



SEES-PPE-005



SEES-PPE-006



SEES-PPE-001



SSEE-013



SSEE-014



EHUS-002



EHUS-003

Safety Equipment

S.E.E.S. #	Description
SAFE-037	Cleaning Wipe, 9" x 16.5" 100 Per box
SEES-MASK-001	Face Mask, KN95 FDA Approved
SEES-MASK-001-20P	Face Mask, KN95 FDA Approved
SEES-MASK-002	Face Shield, Protective
SEES-MASK-003	Face Buff, American Flag, Washable UV Protection
SEES-MASK-004	Face Buff, Blue/Black/Grey Camo, Washable UV Protection
SEES-MASK-005	Face Buff, Pink/Black/Grey Camo, Washable UV Protection
SEES-MASK-006	Face Buff, Blue Ocean Water, Washable UV Protection
SEES-MASK-007	Mask, Face Buff, SEES logo on USA flag, Milk Silk Washable UV Protection
SEES-MASK-008	Mask, Face Buff, SEES logo on Camo, Milk Silk Washable UV Protection
SEES-MASK-009	Mask, SEES Blue, 3 Layer Cotton/Polyester
SEES-MASK-010	Mask, SEES American Flag, 3 Layer Cotton/Polyester
SEES-MASK-011	Mask, SEES Enforcer, 3 Layer Cotton/Polyester
SEES-PPE-001	Auger, Isolation Clothing
SEES-PPE-002	Goggles, Eye Protection
SEES-PPE-003	Instant Hand Sanitizer, 29ML Sold Each
SEES-PPE-003C	Instant Hand Sanitizer, 29ML Sold per Case, 288/case
SEES-PPE-004	Instant Hand Sanitizer, 60ML Sold Each
SEES-PPE-004C	Instant Hand Sanitizer, 60ML Sold per Case, 192/Case
SEES-PPE-005	Instant Hand Sanitizer, 100ML Sold Each
SEES-PPE-006	Instant Hand Sanitizer, 250ML Sold Each
SSEE-013	SEES Solution, Germicidal Cleaner, Case of 12, 20oz
SSEE-014	SEES Solution, Disinfectant Spray Q, Country Fresh, Case of 12, 20oz
EHUS-002	Elevator Cab Sterilizer, 120V
EHUS-002A	Elevator Cab Sterilizer, 190-250V
EHUS-002L	Lamps for Elevator Cab Sterilizer, EHUS-002
EHUS-003	Handrail Sterilizing Lamp
EHUS-6A-CASE	Concentrated Cleaner Conditioner
EHUS-6B-CASE	Concentrated Heavy Duty Cleaner

Work Safe - Reduce Risk

Safety Equipment

S.E.E.S. #	O.E.M. #	Description
SAFE-001	COREHF10S	Glasses, Bulldog Frosted
SAFE-002	PYRGB1810ST	Goggle, V2G Anti-Fog with Clear Lens
SAFE-003	CHMTKE	Retainer, Original Royal Blue Logo
SAFE-004	RTZ1200X	Glove, Leather SGL Palm
SAFE-005	RTZ4090LG	Glove, disposable, Nitrile Powdered, LG, 100/box
SAFE-005-250		Glove, Nitrile LG Box of 250
SAFE-005A	RTZ4090LG	Glove, Nitrile XLG 100
SAFE-005A-250		Glove, Nitrile XLG Box of 250
SAFE-005B-225		Glove, Nitrile 2XL Box of 225
SAFE-006	NORA79R01	Cap, Ratchet Suspense, White, 20 CS
SAFE-007	MILT4500	Harness, Titan Universal, Full Body
SAFE-008	MILT5111	Lanyard, Shock Absorber, 6 ft
SAFE-009	MILT7314	Strap, Cross Arm, 6 ft, Titan
SAFE-010	MILPFL2	Lifeline, Retracting 9', Scorpion
SAFE-011	MILMP20G	Galvanized Cable, Falcon SRL, 20ft
SAFE-012	MILMP30G	Galvanized Cable, Falcon SRL, 30ft
SAFE-013	MEC5834	Rope, 5/8" - 3/4" with Eye
SAFE-014	MIL496	Anchor, Concrete 3/4" 5000#
SAFE-015	MDX6604	Earplug, No Cord
SAFE-016	GER1730N95	Respirator, Particulate
SAFE-017	CEPEP100	Pad Oil
SAFE-017A	CEPEP100	Pad Oil, 100PK
SAFE-018	CEPUQ100	Pad, Universal Gray
SAFE-019	RTZKIT3	Spill Kit, #3
SAFE-020	SWF6834401LF	First Aid Kit, Large Industrial
SAFE-021	SWF68P25R	First Aid Kit, Plastic #25
SAFE-022	TRYRAG25CK	Rag, Knit Colored
SAFE-023	RTZCCC	Caution Tape, Yellow
SAFE-024	MUT159030SHA	Marker, Perimeter Yellow



SAFE-001



SAFE-002



SAFE-003



SAFE-004



SAFE-005



SAFE-006



SAFE-007



SAFE-008



SAFE-009



SAFE-010



SAFE-011



SAFE-012



SAFE-013



SAFE-014



SAFE-015



SAFE-016



SAFE-017



SAFE-018



SAFE-019



SAFE-020



SAFE-021

Work Safe - Reduce Risk

Safety Equipment



SAFE-029



SAFE-031



SAFE-032



SAFE-033



SAFE-035



MIS-500



MIS-500B (Front, Back)

S.E.E.S. #		Description
SAFE-025	KEYDT260	Duct Tape , Grey 2" x 60 Yard
SAFE-026	RTZV211PLG	Vest , Lime Mesh, Class II
SAFE-027	RTZV210PLG	Vest , Orange Mesh, Class II
SAFE-028	FIBE2RWWH	Hard Hat , White with Ratchet Liner
SAFE-029	NWT10523	SEES Bag , 23" Navy Duffel Bag with SEES Logo
SAFE-030	ALG7105	Knee Pads
SAFE-031	MAS410	Padlock , Log Shackle
SAFE-032	SGNTAG10	Lockout Tags , "Do Not Operate" 25PK
SAFE-033	MAS420	Lockout Hasp , 1" Diameter Jaws
SAFE-034	MAS427	Lockout Hasp , Labeled Snap Tag
SAFE-035	71700-10-sw	Rag , Gray Knit 10lb
SAFE-036	71700-50-sw	Rag , Gray Knit 50lb
SAFE-037	344705	Cleaning Wipe , 9" x 16.5" 100 Per box
SAFE-KIT		SAFE-001 thru SAFE-034
SAFE-031	MAS410	Padlock , Log Shackle
SAFE-032	SGNTAG10	Lockout Tags , "Do Not Operate" 25PK
SAFE-033	MAS420	Lockout Hasp , 1" diameter jaws
SAFE-034	MAS427	Lockout Hasp , Labeled Snap Tag
SAFE-035	71700-10-sw	Rag , Gray Knit 10 lb
SAFE-036	71700-50-sw	Rag , Gray Knit 50 lb
SAFE-038	DBI1102043	Harness , Full Body 400 lbs Plus

Safety Gear and First Aid Products



MIS-502



MIS-GLV-001M



MIS-GLV-002



MIS-GLV-003M

S.E.E.S. #	Description
MIS-500	Air-Purifying Respirator – NIOSH/MSHA Certified. This sturdy silicone dual element half-mask respirator is lightweight and comfortable while providing protection from harmful pollutants. Protect yourself from harmful inhalants such as carbon dust, fumes, mist, paint, pesticides and other dangerous lung-damaging irritants. Replace filters as needed, sold separately.
MIS-500B	Refill Filters , for MIS-500
MIS-502	Goggles – The ultimate in eye protection. Comfortable lightweight optical grade polycarbonate lens provide greater visibility and protection while the soft pliable nosepiece provides a seal around nose and cheeks. Can be worn over glasses. Fog guard treated lens.
MIS-GLV-001	Gloves , Full Finger Maintenance, large
MIS-GLV-001M	Gloves , Full Finger Maintenance, medium
MIS-GLV-001X	Gloves , Full Finger Maintenance, xlarge
MIS-GLV-002	Gloves , Open Finger Contractor, large
MIS-GLV-002M	Gloves , Open Finger Contractor, medium
MIS-GLV-002X	Gloves , Open Finger Contractor, xlarge
MIS-GLV-003	Gloves , Cable Pullers, large
MIS-GLV-003M	Gloves , Cable Pullers, medium



BARRACADA™

**PORTABLE.
TRANSFORMABLE.
AFFORDABLE.**



**A downsized barricade,
for downsized service
vehicles**

The Barracada's lightweight construction, sleek design and convenient shoulder strap make it the most portable barricade on the market and perfect for fitting into newer, compact service vehicles.

CAUTION!

Don't Overpay for Barricades

Save money and space with the Barracada. This surprisingly compact and aggressively inexpensive accordion-fold barricade has a no-fuss design that allows you to erect or dismantle it in seconds!

Accordion-Fold Configurations



BARR-007-08P



BARR-008



BARR-005

**Use SEES rigid interlocking
configurations for added support**



BARR-006



BARR-007-08P

*All Barracada Kits come with 2 locks, 2 suction cups and 1 shoulder strap.

KITS	PANELS	PRICE
BARR-007-06P*	6	\$125.00
BARR-007-08P*	8	\$150.00
BARR-007-10P*	10	\$175.00
BARR-007-12P*	12	\$200.00
ADDITIONAL COMPONENTS		
BARR-007A	Single Panel, "Caution"	\$15.00
BARR-007B	Single Panel, "Do Not Enter"	\$15.00
BARR-005	Anchor Kit	\$22.00
BARR-006	Lock	\$7.50
BARR-008	EZ Grip Lock Kit	\$65.00

CALL NOW: 800.526.0026

Always Smooth Sailing

Safety Gear and First Aid Products

Floor Decals

S.E.E.S. #	Description
MIS-166FD-01	Floor Decal, 1 Passenger Max, Pack of 10
MIS-166FD-02	Floor Decal, 2 Passenger Max, Pack of 10
MIS-166FD-03	Floor Decal, 3 Passenger Max, Pack of 10
MIS-166FD-04	Floor Decal, 5 Passenger Max, Pack of 10
MIS-166FD-05	Floor Decal, Stand Here, Pack of 10
MIS-166FD-06	Floor Decal, Please Keep Social Distance, Stand Here, Pack of 10
MIS-166FD-07	Floor Decal, Please Practice Social Distancing, 6 Feet, Pack of 10
MIS-166FD-08	Floor Decal, Please Stand Here, Face Mask Required, 6 Ft Distance Marker in English & Spanish, Pack of 10
MIS-166FD-09	Floor Decal, Please Remain 6 Ft Apart At All Times, Pack of 10
MIS-166QA	Sign, "CAUTION Secure Elevator From Movement Before Entering Upper Pit Area"



MIS-166FD-01



MIS-166FD-06



MIS-166FD-07



MIS-166FD-09



BARR-001A



BARR-002



BARR-003



BARR-005



BARR-004



BARR-007A



BARR-006



BARR-007O



BARR-007R



BARR-008

Barricades

S.E.E.S. #	Description
BARR-001A	Barricade, 36" W x 42" H Panel 10mm Thick
BARR-002	Barricade, 36" W x 72" H Panel 10mm Thick
BARR-002K	Barricade, (3) 36" W x 72" H 10mm with (2) Anchors & (2) Locks
BARR-003	Barricade, (3) 36" W x 42" H Panels with Anchors and (2) locks 10mm Thick
BARR-003-LOGO	Barricade, (3) 36" W x 42" H 10MM
BARR-004	Barricade, (4) 36" W x 42" H Panels with Anchors and (3) Locks 10mm Thick
BARR-004-LOGO	Barricade, (4) 36" W x 42" H 10MM
BARR-005	Barricade, Anchor Kit
BARR-006	Barricade, Lock
BARR-007O	Reflective Safety Flasher, orange
BARR-007R	Reflective Safety Flasher, red
BARR-008	EZ Grip, Barricade Lock for escalators, Set of 2 Locks
BARR-008A	Barricade, (3) 36" W x 42" H 10mm with (2) Anch, Locks, & EZ-Grips
BARR-008B	Barricade, (4) 36" W x 42" H 10mm (3) Locks (2) Anch & EZ-Grips
BARR-011	Barricade, 40" H, Expands to 141" Portable Steel Scissor w/ Caster

Features:

- Light, portable easy to use
- Prevents accidents
- Reduce risk during routine maintenance

Barracada

S.E.E.S. #	Description
BARR-007A	SEES Barracada, Single Panel, "Caution"
BARR-007B	SEES Barracada, Single Panel, "Do not Enter"
BARR-007-06P	SEES Barracada, 6 Panel with (2) Anchors & (2) Locks
BARR-007-08P	SEES Barracada, 8 Panel with (2) Anchors & (2) Locks
BARR-007-10P	SEES Barracada, 10 Panel with (2) Anchors & (2) Locks
BARR-007-12P	SEES Barracada, 12 Panel with (2) Anchors & (2) Locks



BARR-007B



BARR-007-08P



BARR-007-10P

Ground Fault Protection

S.E.E.S. #	Description
30334008	GFCI Plug, right angle, with triple tap, 2 ft.
30334052	GFCI, right angle, protected quad outlet box
30338018	GFCI, in-line cord set, 18"
30338024	GFCI, in-line with triple tap, 3 ft.
30339005	Adapter, 3-wire outlet



30334008



30338018



SEES-JUMPER-001



30334052

Jumper Kit

S.E.E.S. #	Description
SEES-JUMPER-001	SEES Jumper Kit, used for temporarily jumping out circuits while under repair. Jumper test lead with pouch, includes alligator clip, spring loaded plunger, and lug terminal.
SEES-JUMPER-001F	SEES Fused Jumper Kit, Jumper test lead kit with pouch, 250V / 0.5A Glass Fuse
SEES-JUMPER-001K	SEES Jumper Kit, Test Kit with Pouch and Wrist Band
SEES-JUMPER-002	SEES Jumper, Time Out
SEES-JUMPER-003	SEES Jumper, Banana Plug 2mm x Long Red 18AWG
SEES-JUMPER-004	SEES Jumper, Tip Black
SEES-JUMPER-005	SEES Jumper, Tip Red
SEES-JUMPER-006	SEES Jumper kit, 3 Gator Clips 6 Test Pins, Pouch, Wrist Band
SEES-JUMPER-007	Magnetic Jumper
SEES-JUMPER-008	Safety Labels, Bag of 25 Self-Adhesive for Jumper Wires
SEES-JUMPER-009	Jumper Adapter, Bag of 4
SEES-JUMPER-BAND	SEES, Wrist Band "No Jumper Left Behind"
SEES-JUMPER-POUCH	SEES, Jumper Pouch Only Blue with Velcro



SEES-JUMPER-002



SEES-JUMPER-003



BARRICADE SALE!



- ✓ LIGHT AND PORTABLE
- ✓ PREVENTS ACCIDENTS
- ✓ EASY TO USE AND CLEAN
- ✓ RUGGED CONSTRUCTION

 **CALL NOW: 800.526.0026**

UNBEATABLE SAVINGS!

BARR-001A

36" W X 42" H panel, 10mm thick

LIST: ~~\$28~~
SALE PRICE: \$22



BARR-003

(3) 36" W x 42" H panels, 10mm thick, with anchors and (2) locks

LIST: ~~\$140~~
SALE PRICE: \$110



BARR-004

(4) 36" W x 42" H panels, 10mm thick, with anchors and (3) locks

LIST: ~~\$175~~
SALE PRICE: \$140





SEES-JUMPER-001F

SAVES MONEY
SAVES LIVES

Human error is inevitable and even the best of us can make a mistake once in a while. Poorly lit machine rooms, hard to reach electrical components and electrical wiring diagram errors are just a few of the contributors to these mistakes.

The SEES fused jumper minimizes the potential damage to technicians and elevator components.

*Replaceable fuse up to 5 amps,
1/4" glass fuse* ∨

ADVANTAGES

- » Adds an extra layer of electrical isolation/protection
- » Prevents electric shock to mechanic
- » Prevents damage to components
- » Happy technicians

STANDARD JUMPER KIT DISADVANTAGES

- » Injured technicians
- » Costly board replacement
- » Increased insurance costs
- » Angry customers
- » Downtime



» INCLUDES

-  Jumper Wire, Alligator Clips
-  Jumper Wire, Plunger Type
-  SEES Jumper, Yellow Adaptor Pin
-  Velcro Pouch, SEES Jumper Kit
-  SEES, Wrist Band
-  Safety Labels, Self Adhesive



Always Smooth Sailing

2781 West McNab Rd, Pompano Beach, FL 33069 • (800) 526-0026 • www.SEESinc.com

PPE

CALL TODAY: 800-526-0026



SEES-MASK-009
\$5.00 EA



SEES-MASK-010
\$5.00 EA



SEES-MASK-011
\$5.00 EA



SAFE-005
\$30 / pack (100) LG Nitrile

SAFE-005A
\$30 / pack (100) XLG Nitrile



SEES-PPE-003 (29ML)
\$2.00 / \$420 for case (288)

SEES-PPE-004 (60 ML)
\$2.50 / \$420 for case (192)

SEES-PPE-005 (100ML)
\$3.00 / \$250 for case (96)

SEES-PPE-006 (250ML)
\$6.00 / \$225 for case (48)



Germicidal Cleaner
SSEE-013
\$120.00 for 12-pack



KN95 FACE MASKS

SEES-MASK-001
\$4.20 EA

SEES-MASK-001-20P
\$60.00 (pack of 20)

Five 20-packs for \$55 EA



Disinfectant Spray
SSEE-014
\$100.00 for 12-pack



SEES-MASK-003
\$3.00 EA



SEES-MASK-004
\$3.00 EA



SEES-MASK-005
\$3.00 EA



SEES-MASK-006
\$3.00 EA

UV protection • washable • reusable

SIGNS AND BRAILLE

QUICK LOCATOR GUIDE

Braille	459-462
Crescent Braille Plates	461-462
Fire Exit Sign in Braille	459
Rectangular Door Jamb Plates.....	459
Round Braille Plates.....	460
Square Braille Plates	460
Unique Sizes & Characters.....	461
Capacity Plates	458
Fire Exit Instruction Signs	454
Firefighter’s Instruction Signs	455
General Information Signs	456
Caution Signs.....	456
Danger Signs	456
Escalator Signs	456
Freight Elevator Signs	456
No Smoking Signs.....	456
Hoistway I.D. Plaques	458
Test Record Signs	457

Signs



MIS-166



MIS-166E



MIS-166K



MIS-166KA-M



MIS-166E-VAN



MIS-166HL



MIS-166HL1



MIS-166KA



MIS-166KA-S



MIS-166-GEN

Fire Exit Instruction Signs

S.E.E.S. #	Description
MIS-166	Fire Sign , "In case of fire do not use elevators use stairways" 5 1/2" x 8 1/2" Plastic, with 1/2 Lettering, Self Adhesive Backing
MIS-166E-C	Sign , "In Case of Fire Use Stairs", with braille 5-1/2" x 10-3/4"
MIS-166E	Fire Sign , "In case of fire do not use elevators" 5-1/2" x 8-1/2", Stainless Steel
MIS-166E-VAN	Sign , "In Case Of Fire" 6" x 10" SS, etched, vandal resistant
MIS-166HL	Sign , "In Case of Fire" 6" x 7"
MIS-166HL1	Sign , "In Case of Fire, Do Not Use Lift", 5" x 8", Tri Flame
MIS-166K	Fire Sign , "In case of fire elevators are out of service, "USE EXIT" 5-1/2" x 8-1/2" Stainless Steel, Self Adhesive Backing
MIS-166KA	Fire Sign , "USE EXIT STAIRS", 6" x 7", plastic with white back, Self Adhesive Backing
MIS-166KA-S	Fire Sign , Stainless Steel Fire Exit Stairs W/Self Adhesive Back
MIS-166KE	Fire Sign , "USE EXIT STAIRS", 5" x 7" Stainless, Engraved & Filled, Self Adhesive
MIS-166-GEN	Fire Sign , Main Station "Use Stairway" 6" x 7", white plastic
MIS-166CB	Circuit Breaker Safety , 5" x 3.75", Self Adhesive
MIS-166XA	Fire Sign , Reset Phs I, 6" x 6" Red on white plastic with Flame Symbol
MIS-166KA-M	Fire Sign , Muntz Fire Exit Stairs w/ Self Adhesive Back, 5-1/2" x 8-1/2"

Signs

Firefighters' Instructions

S.E.E.S. #	Description
MIS-166L	Fire Sign , Firemens Instructions for Elevator Car Station, Phase 2, OFF/HOLD/ON 5-1/2" x 8-1/2" Stainless Steel
MIS-166M	Fire Sign , Firemens Instructions for Main Station, Phase 1 Hall, 5-1/2" x 8-1/2" Stainless Steel
MIS-166M-R	Fire Sign , Fire Instructions with Reset for main station
MIS-166N	Fire Sign , Firemens Instructions for Elevator Car Station, Phase 2, OFF/ON 5-1/2" x 8-1/2" Stainless Steel
MIS-166U	Fire Sign , Firefighter's Operation Instructions ANSI II 1998, 6" x 10" Aluminum, self adhesive
MIS-166UA	Fire Operation Instruction , 6" x 6" A17.1, 1996-2004 Phase II
MIS-166UB	Fire Operation Instruction , 6" x 6" A17.1, 1989-1995 Phase II
MIS-166UC	Fire Operation Instruction , 6" x 6" A17.1, 2005 & up Phase II
MIS-166UD	Fire Operation Instruction , Black Back/Silver Letters 6.9" x 4.4", PH II, ANSI 1973
MIS-166X	Sign , Firefighter Operations, Phase 1
MIS-166-PLATE	Blank Stainless Cover Plate , 3" x 4" 16GA 304SS #4 Brush, self adhesive



MIS-166L

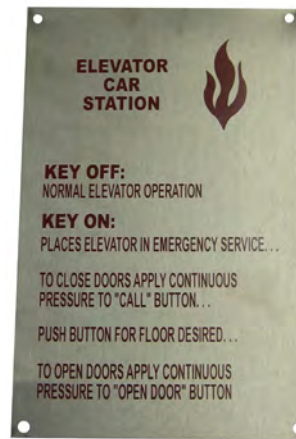

MIS-166N



MIS-166M



MIS-166M-R

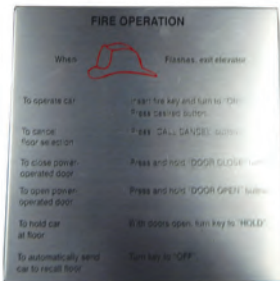

MIS-166UA

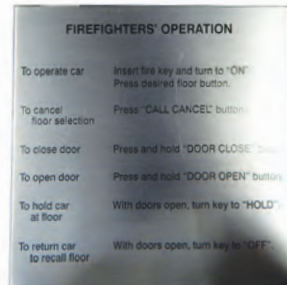

MIS-166UB

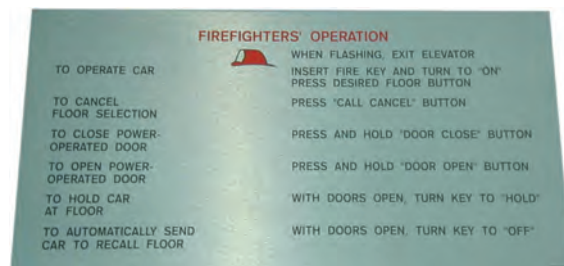

MIS-166U

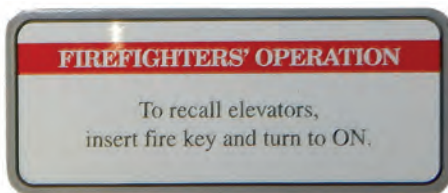

MIS-166X

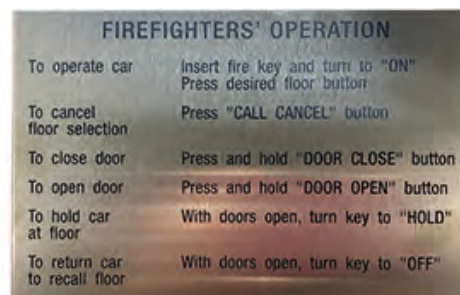

MIS-166UD

Signs



MIS-166FD-01



MIS-166FD-05



MIS-166FD-06



MIS-166FD-07



MIS-166FD-08



MIS-166FD-09

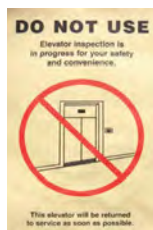

022-6-0001



MIS-166C



MIS-166F



MIS-166G



MIS-166G-1



MIS-166Q



MIS-166W



MIS-166-SOL



MIS-166-SOL-WH



MIS-166H

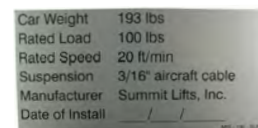

MIS-166-SUM

Floor Decals

S.E.E.S. #	Description
MIS-166FD-01	Floor Decal, 1 Passenger Max, Pack of 10
MIS-166FD-02	Floor Decal, 2 Passenger Max, Pack of 10
MIS-166FD-03	Floor Decal, 3 Passenger Max, Pack of 10
MIS-166FD-04	Floor Decal, 5 Passenger Max, Pack of 10
MIS-166FD-05	Floor Decal, Stand Here, Pack of 10
MIS-166FD-06	Floor Decal, Please Keep Social Distance, Stand Here, Pack of 10
MIS-166FD-07	Floor Decal, Please Practice Social Distancing, 6 Feet, Pack of 10
MIS-166FD-08	Floor Decal, Please Stand Here, Face Mask Required, 6 Ft Distance Marker in English & Spanish, Pack of 10
MIS-166FD-09	Floor Decal, Please Remain 6 Ft Apart At All Times, Pack of 10
MIS-166QA	Sign, "CAUTION Secure Elevator From Movement Before Entering Upper Pit Area"

General Signs

S.E.E.S. #	Description
022-6-0001	Sign, "Do Not Use", 4" x 6", self-adhesive, 50 per pack
MIS-166C	Sign, "NON SMOKING AREA", 5-1/2" x 8-1/2" Stainless Steel, Self Adhesive Backing
MIS-166F	Sign, "Danger Electrical Machinery..." 7" x 10" Poly-vinyl self adhesive
MIS-166G	Sign, Escalator Warning "CAUTION, Hold Handrail, Attend Children.." 4" x 7-1/2" Poly-vinyl, self adhesive
MIS-166GS	Sign, Escalator Warning "CAUTION, Hold Handrail", 3-1/4" x 6", Poly-vinyl
MIS-166GT	Sign, Escalator Safety 4 x 8
MIS-166G-1	Sign, Escalator Warning "CAUTION, No Strollers Permitted..." 4" x 7-1/2" Poly-vinyl, self adhesive
MIS-166Q	Sign, "Caution This Device Powered....." 5" x 7", plastic
MIS-166W	Sign, Yellow self adhesive Escalator sign, 004" (Do not use as stairs), yellow and black
MIS-166H	Sign, Freight "This is not a passenger elevator..." 5-1/2" x 8-1/2" Stainless Steel
MIS-166-SOL	Sign, Star of life 4" x 4" Stainless steel medical sign, self adhesive
MIS-166-SOL-WH	Sign, Star Of Life 4" x 4" White Background with Self Adhesive
MIS-166-SUM	Sign, Data Tag Summit Lift 3.25" x 6.625", .030" aluminum, adhesive
SEES-SIGN-FUSL-TH	Sign, "Fire Service Use Stairs" Appendix "O" Flame Plastic Insert, Large

Test Record Signs

S.E.E.S. #	Description	<i>*Also available in rivet mount.</i>
MIS-166P*	Test Tag, Date Record of hydro tests to be displayed as required 4" x 3-1/2" Aluminum, self adhesive	
MIS-166R*	Test Tag, Traction (1 Year) 3-1/2" x 4" Aluminum, self adhesive	
MIS-166S*	Test Tag, Traction (5 Year) 3-1/2" x 4" Aluminum, self adhesive	
MIS-166T*	Test Tag, Escalator (1 Year) 3-1/2" x 4" Aluminum, self adhesive	
MIS-166AA	Data Tag, 1.625" H x 3" W	
MIS-166AA-A171	Code Data Tag, ASME A17.1 1.625" H x 3" W	
MIS-166AB	Data Tag, for Hydro specs 2-1/2" x 5" self adhesive	
MIS-166AC	Data Tag, 3" x 4" Alum Self adhesive Code ASME A17-2000.8.9	
MIS-166AD	Data Tag, Wire Rope 3" x 4"	
MIS-166AE	Data Tag, Door Data Plate 4" x 7"	
MIS-166AF	Data Tag, 3" x 4" Alum Self Adh Code ASME A17-2007.8.9	
MIS-166AG	Test Tag, 2" x 3.5" aluminum hydro pressure test	
MIS-166B	Label, "POWERED FROM" 3" x 1" Per NEC rule 620.51(D) *5PKG*	
MIS-1660	Tag, Out of Service 25pk	
MIS-166R-SLC	Test Tag, Traction 1 Year	
MIS-166Y	Sign, Oil Gauge level magnetic	
MIS-166Z	Sign, Brake Torque Tag FT/LB 1-1/2" H x 2-1/2" W	
MIS-166-MCP	Label, Maintenance Control Program, 4" x 6" w/ rounded corners	
SAFE-032	Lockout Tags, "Do Not Operate", 25 PK	
THY-SIGN-001	Code Data Tag, Thyssen, 3.5 x 5"	
THY-SIGN-002	Hydro Code Data Tag, Thyssen, 3.5 x 5"	

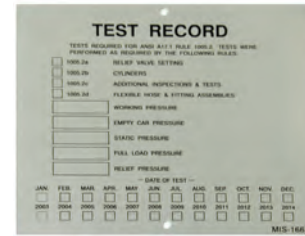

MIS-166P

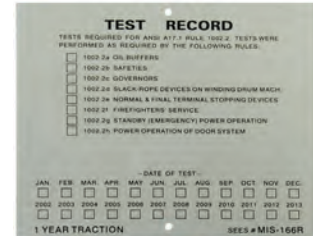

MIS-166R



MIS-166AA



MIS-166S

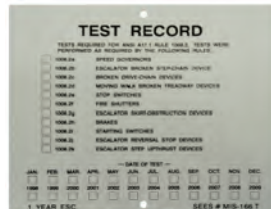

MIS-166T



MIS-166AA-A171



MIS-166AB



MIS-166AD



MIS-166AF

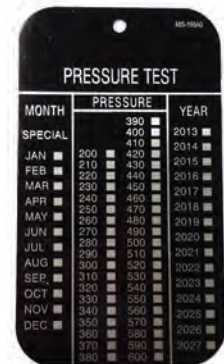

MIS-166AG

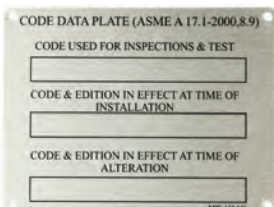

MIS-166AC



MIS-166B

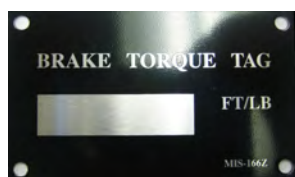

MIS-166Z



MIS-1660



MIS-166Y



SAFE-032

Plaques



MIS-166D-950



MIS-166D-950HL



MIS-166D-1800



MIS-166D-2500



MIS-HD4-1



MIS-HD4A-4



MIS-HD4A-5

Capacity Plates 2" x 4" Stainless Steel

S.E.E.S. #	Description	
MIS-166D-950	Capacity Plate	950 lbs.
MIS-166D-950HL	Capacity Plate	950 lbs.
MIS-166D-1000	Capacity Plate	1000 lbs.
MIS-166D-1200	Capacity Plate	1200 lbs.
MIS-166D-1500	Capacity Plate	1500 lbs.
MIS-166D-1800	Capacity Plate	1800 lbs.
MIS-166D-2000	Capacity Plate	2000 lbs.
MIS-166D-2500	Capacity Plate	2500 lbs.
MIS-166D-3000	Capacity Plate	3000 lbs.
MIS-166D-3500	Capacity Plate	3500 lbs.
MIS-166D-4000	Capacity Plate	4000 lbs.
MIS-166D-4500	Capacity Plate	4500 lbs.
MIS-166D-5000	Capacity Plate	5000 lbs.
MIS-166D-5500	Capacity Plate	5500 lbs.
MIS-166D-8000	Capacity Plate	8000 lbs.
MIS-166D-10000	Capacity Plate	10000 lbs.
MIS-166D-BLANKS	Capacity Plate	Blank

Hoistway I.D.

S.E.E.S. #	Description
MIS-HD4-SPECIAL	Hoistway I.D. Plaque, Aluminum 4" SS Character/Black Background Self Adhesive, specify marking, examples below
MIS-HD4-1	Hoistway I.D. Plaque, Aluminum Marked "Elevator 1"
MIS-HD4-2	Hoistway I.D. Plaque, Aluminum Marked "Elevator 2"
MIS-HD4-3	Hoistway I.D. Plaque, Aluminum Marked "Elevator 3"
MIS-HD4-4	Hoistway I.D. Plaque, Aluminum Marked "Elevator 4"
MIS-HD4-5	Hoistway I.D. Plaque, Aluminum Marked "Elevator 5"
MIS-HD4A-SPECIAL	Hoistway I.D. Plaque, Plastic 4" White Character/Black Background Self Adhesive, specify marking, examples below
MIS-HD4A-1	Hoistway I.D. Plaque, Plastic 4" Marked "Elevator 1"
MIS-HD4A-2	Hoistway I.D. Plaque, Plastic 4" Marked "Elevator 2"
MIS-HD4A-3	Hoistway I.D. Plaque, Plastic 4" Marked "Elevator 3"
MIS-HD4A-4	Hoistway I.D. Plaque, Plastic 4" Marked "Elevator 4"
MIS-HD4A-5	Hoistway I.D. Plaque, Plastic 4" Marked "Elevator 5"
MIS-HD4A-6	Hoistway I.D. Plaque, Plastic 4" Marked "Elevator 6"
MIS-HD4B-SPECIAL	Hoistway I.D. Plaque, Aluminum 4" Black Character/SS Background Self Adhesive, specify marking, examples below, CHECK STOCK
MIS-HD4B-1	Hoistway I.D. Plaque, Aluminum Marked "Elevator 1"
MIS-HD4B-2	Hoistway I.D. Plaque, Aluminum Marked "Elevator 2"
MIS-HD4B-3	Hoistway I.D. Plaque, Aluminum Marked "Elevator 3"
MIS-HD4B-4	Hoistway I.D. Plaque, Aluminum Marked "Elevator 4"
MIS-HD4B-5	Hoistway I.D. Plaque, Aluminum Marked "Elevator 5"
MIS-HD4BR-SPECIAL	Hoistway I.D. Plaque, Aluminum 4" bronze Character/Black Background, Self Adhesive, specify marking, examples below
MIS-HD4BR-1	Hoistway I.D. Plaque, Aluminum Marked "Elevator 1"
MIS-HD4BR-2	Hoistway I.D. Plaque, Aluminum Marked "Elevator 2"
MIS-HD4BR-3	Hoistway I.D. Plaque, Aluminum Marked "Elevator 3"
MIS-HD4BR-4	Hoistway I.D. Plaque, Aluminum Marked "Elevator 4"
MIS-HD4BR-5	Hoistway I.D. Plaque, Aluminum Marked "Elevator 5"
MIS-HD4BR-6	Hoistway I.D. Plaque, Aluminum Marked "Elevator 6"
MIS-HD4B-SPECIAL	Hoistway I.D. Plaque, 5" x 4" Aluminum, SS Character/Black Background, Self Adhesive, specify marking
MIS-HD54-SPECIAL	Hoistway I.D. Plaque, 5" x 4" Aluminum, SS Character/Black Background, Self Adhesive, specify marking

Braille

Braille Fire Sign

S.E.E.S. #	Description
MIS-166E-B	Sign, "In case of fire do not use elevators...", in Braille, 5-1/2" x 1-1/2" Die Cast Aluminum



MIS-166E-B

Jamb Braille & Signs

S.E.E.S. #	O.E.M. #	Description
MIS-BR32-		Braille Plate , door jamb, rectangle, 3.5" L x 2.5" H, white character on black metal background, specify marking
MIS-BR32A-		Braille Plate , door jamb, rectangle, 3.5" L x 2.5" H, stainless steel character on black metal, elevator entrance jamb plate, specify marking
MIS-BR2125B-SPECIAL	EC12WB	Braille Plate , Door Jamb, 2" L x 1.25" H White Characters. Black Back Metal
MIS-BR21EC12SSB-1		Braille Plate , Door Jamb 2" L x 1.25" H, SS on Black Background
MIS-BR21EC12SSB-2		Braille Plate , Door Jamb 2" L x 1.25" H, SS on Black Background
MIS-BR21EC12SSB-3		Braille Plate , Door Jamb 2" L x 1.25" H, SS on Black Background
MIS-BR21EC12SSB-4		Braille Plate , Door Jamb 2" L x 1.25" H, SS on Black Background
MIS-BR21EC12SSB-5		Braille Plate , Door Jamb 2" L x 1.25" H, SS on Black Background
MIS-BR21EC12SSB-6		Braille Plate , Door Jamb 2" L x 1.25" H, SS on Black Background
MIS-BR21EC12SSB-STAR_1		Braille Plate , Door Jamb 2" L x 1.25" H, SS on Black Background
MIS-BR4-		Braille Plate , Square, 4" x 4", Injection molded, white character on black plastic background, elevator entrance jamb plate, specify marking i.e. MIS-BR4-2, shown
MIS-BR4B-		Braille Plate , square, 4" x 4", stainless character on black metal background, elevator entrance jamb plate, adhesive, specify marking i.e. MIS-BR4B-LR, shown
MIS-BR4BR-		Braille Plate , square, 4" x 4", Bronze characters, black background
MIS-BR4S-		Braille Plate , square, 4" x 4", black character on stainless background, elevator entrance jamb plate, adhesive, specify marking i.e. MIS-BR4S-3, shown
MIS-166-JAMB-FIREHAT		Jamb Sign , Brushed SS 3" x 3" Marked with Fire Hat in Black, Self Adhesive



MIS-BR32-5



MIS-BR32A-4



MIS-BR4-2



MIS-BR4B-LR



MIS-BR4S-3



MIS-166-JAMB-FIREHAT

Braille



MIS-BR1.25-1



MIS-BR1.25B-UP_ARROW



MIS-BR1.25B-DOOR_OPEN



MIS-BRS1.25NB-STAR-1



MIS-BRS1.25WB-PHONE



MIS-BR1.375RSSB-G



MIS-BR1.375RBSS-13



MIS-BR1.375RBW-13



MIS-BR1.375RBB-4



MIS-BRS1.375WB-1



MIS-BR1.50RBW-LL2



MIS-BRS1.375NB-2

Square Braille Plates

S.E.E.S. #	Description
MIS-BR1.25-	Braille Plate , square, 1.25" x 1.25" with .125" radius corners, stainless steel character on black background, adhesive, specify marking i.e. MIS-BR1.25-1, shown
MIS-BR1.25B-UP_ARROW	Braille , square, 1.25" x 1.25", black character on stainless steel background
MIS-BR1.25B-DOOR_OPEN	Braille , square, 1.25" x 1.25", black character on stainless steel background
MIS-BR1.25SBB	Braille , square, 1.25", Satin Bronze Marking, Black Background, Specify Marking
MIS-BR1.25SBB-SPECIAL	Braille , square, 1.25", Satin Bronze Marking, Black Background, Specify Marking
MIS-BR1.50RBW-2	Braille , round, 1.50", Black Metal, White Char, Self Adh
MIS-BR1.50RBW-SPECIAL	Braille , round, 1.50", Black Metal, White Char, Self Adh
MIS-BR1.50RBW-STAR_1	Braille , round, 1.50", Black Metal, White Char, Self Adh
MIS-BRS1.25WB-	Braille Plate , square, 1.25", White on Black, Die Cast Stud Mount. Specify marking i.e. MIS-BRS1.25WB-PHONE shown
MIS-BRS1.25WB-P	Braille , square, 1.25", "P" White/Black, Die Cast Stud Mount
MIS-BRS1.25WB-STAR-L	Braille , square, 1.25", Star-1 White/Black Die Cast Stud Mount
MIS-BRS1.25NB-	Braille Plate , square, 1.25", Nickel on Black, Die Cast Stud Mount, Specify marking i.e. MIS-BRS1.25NB-STAR-1 shown
MIS-BRS1.375NB-1R	Braille Plate , 1.375RD, "1R" Nickel/Black Die Cast Stud Mount

Round Braille Plates

S.E.E.S. #	O.E.M. #	Description
MIS-BR1.375RSSB-		Braille Plate , round, 1.375", black character, stainless steel background, self adhesive. Specify marking i.e. MIS-BR1.375RSSB-G shown
MIS-BR1.375RBSS-		Braille Plate , round, 1.375", stainless steel character on black background, metal, self adhesive. Specify marking i.e. MIS-BR1.375RBSS-13 shown
MIS-BR1.375RBW-		Braille Plate , round, 1.375", white character on black background, metal, self adhesive. Specify marking i.e. MIS-BR1.375RBW-13 shown
MIS-BR1.375RBB-		Braille Plate , round, 1.375", bronze character on black background, metal, self adhesive. Specify marking i.e. MIS-BR1.375RBB-4 shown
MIS-BRS1.375WB-		Braille Plate , round, 1.375", White on Black, Die Cast Stud Mount. Specify marking i.e. MIS-BRS1.375WB-1 shown
MIS-BRS1.375WB-S		Braille Plate , round, 1.375", "S" White/Black Die Cast Stud Mount
MIS-BRS1.375NB-		Braille Plate , round, 1.375", Nickel on Black, Die Cast Stud Mount. Specify marking i.e. MIS-BRS1.375NB-2 shown
MIS-BR1.50RBW-	EC15RWB	Braille , Round 1.50" Black Metal. White Characters. Self Adhesive. Specify marking i.e. MIS-BR1.50RBW-LL2 shown

*Need a sign that's not shown? Just ask!
We will custom make any sign
to your requirements.*

Unique Sizes & Characters

S.E.E.S. #	Description
MIS-BR1.25SS-SPECIAL	Braille, 1.25" Sq Stainless Steel marking with Stainless Steel Background
MIS-BR21EC12SSB-SPECIAL	Braille, Door Jamb 2" L x 1.25" H, Stainless Steel on Black
MIS-BR21-PH11	Braille, Door Jamb 2" L x 1.25" H White Character Black Back Metal
MIS-BR325-SPECIAL	Braille, Door Jamb 3.25" x 3.25", Stainless Steel Characters
MIS-BR34SB-SPECIAL	Braille, 3" W x 4" H, Stainless Steel Characters with black Background
MIS-BR4BB-SPECIAL	Braille, 4" Sq Black Char On Brass Background Special Marking
MIS-BR54B-SPECIAL	Braille, 5" x 4", Black with Stainless Steel Marking
MIS-BR54BSS-SPECIAL	Braille, 5" x 4", Stainless Steel with Black Marking
MIS-BR54WB-SPECIAL	Braille, 5" x 4", Black Metal Background, White Marking
MIS-BR64WB-SPECIAL	Braille, 6" x 4", Black with White Marking
MIS-BR74B-SPECIAL	Braille, 7" x 4", Black with Stainless Steel Marking
MIS-BRRJ45WB-SPECIAL	Braille, 5" x 4", Black Plastic Background, White Marking
MIS-BR1.5CC6SNBA-SPECIAL	Braille, Round 1.50", Metal, Black Background, Stainless Steel
MIS-BRCJ12-SPECIAL	Braille, 2.75" W x 3.75" H, Black Background with Nickel Painted Char. and Boarder
MIS-BRCJ12BS-SPECIAL	Braille, 2.75" W x 3.75" H, Black Background with Sat. Bronze Painted Char. and Boarder

Crescent Braille Plates

S.E.E.S. #	Description
MIS-BR1.375CBSSM-	Braille Plate , crescent, 1.375" x 2.050", stainless steel character on black background, metal. Studs and hardware included, specify marking i.e. MIS-BR1.375CBSSM-B, shown
MIS-BR1.375CBWM-	Braille Plate , crescent, 1.375" x 2.050", white character on black background, metal. Studs and hardware included. Specify marking i.e. MIS-BR1.375CBWM-G, shown
MIS-BR1.375CBWM-SPECIAL	Braille Plate , crescent, 1.375" x 2.050", white character on black background, metal. Studs and hardware included. Special marking.
MIS-BR1.375CBWP-	Braille Plate , crescent, 1.375" x 2.050", white character on black background, plastic. Studs and hardware included. Specify marking i.e. MIS-BR1.375CBWP-26, shown
MIS-BR1.375CW2WB-	Braille Plate , 1.375" Crescent, white character on black background, Die Cast Stud Mount, 1.560" x 1.358". Specify marking
MIS-BR1.375CW2WB-DOOR-HOLD	Braille Plate , 1.375" Crescent, "Door Hold" White/Black, Die Cast Stud Mount, 1.560" x 1.358"
MIS-BR1.375CW2NB-	Braille Plate , 1.375" Crescent, nickel character on black background, Die Cast Stud Mount, 1.560" x 1.358". Specify marking
MIS-BR1.375CW2NB-1R	Braille Plate , 1.375" Crescent, "1R" Nickel/Black Die Cast Stud Mount, 1.560" x 1.358"
MIS-BR1.375CW2NB-GR	Braille Plate , 1.375" Crescent, "GR" Nickel/Black Die Cast Stud Mount, 1.560" x 1.358"
MIS-BR1.375CW2NB-PH	Braille Plate , 1.375" Crescent, "PH" Nickel/Black Die Cast Stud Mount, 1.560" x 1.358"
MIS-BR1.375CBSSP-	Braille Plate , crescent, 1.375" x 2.050", silver character on black background, plastic. Studs and hardware included. Specify marking i.e. MIS-BR1.375CBSSP-17, shown
MIS-BR1.375CBSSP-SPECIAL	Braille Plate , crescent, 1.375" x 2.050", silver character on black background, plastic. Studs and hardware included. Special marking.
MIS-BR1.375CCU1BSS-	Braille Plate , crescent 2.05" x 1.375", Metal Black with silver character. Specify marking
MIS-BR1.375CCU1BSS-SPECIAL	Braille Plate , crescent 2.05" x 1.375", Metal Black with silver character. Special marking.



MIS-BR1.375CBSSM-B



MIS-BR1.375CBWM-G



MIS-BR1.375CBWP-26



MIS-BR1.375CBSSP-17

Braille

Crescent Braille Plates

S.E.E.S. #	Description
MIS-BR1.375CBBM-	Braille Plate , crescent, 1.375" x 2.050", bronze character on black background, metal. Studs and hardware included. Specify marking i.e. MIS-BR1.375CBBM-STAR-1, shown
MIS-BR1.375CBBM-SPECIAL	Braille Plate , crescent, 1.375" x 2.050", bronze character on black background, metal. Special marking.



MIS-BR1.375CBBM-STAR-1

*For More Braille Plate Options,
See Individual Catalog Sections
OR*

Just ask!

*We will custom make any Braille Plate
to your requirements.*

TOOLS - LUBRICANTS

QUICK LOCATOR GUIDE

Books, Elevator Manuals	489
Brush Tension Scale	483
Burnishing Tools	481
Cable Jacket Remover	477
Caliper, Wire Rope	478
Cleaners	486-487
Commutator Dressing and Finishing Stones	481
Commutator Treating Kit, Brush Seating Stones	480
Contact Burnishing Tools	477
Diamond Spatulas	483
Door Sill Brush	475
Door Wedge Tools	475
Flexible Files, Abrasives	482
Ground Fault Protection	476
Hydraulic Tools	468-469
Jumper Kit	465
Lamp and Fuse Removers	475
Lights, Drop Light, Flashlight, Area Light	478
Lock Out Tools	476
Lubricants	485-486
Meters, AC/DC Clamp on, Special Purpose	470-474
Multi-Meter Accessory Test Kit	464
Multi-Meter Selection Guide	470
Parameter Tool	478
Pressure Gauges	464
Rail Blocks	476
Rail Files, Holder, Handle	477
Rail Lubricator and Supplies	486
Relay Adjuster's Tool Kit	480
Relay Testers, Multi-Volt Meter	479
Rope Oilers and Supplies	486
Screwdrivers and Fasteners	485
Sealants	486-487
SEES Library, Reference Manuals, Handbooks	489
SEES Solutions	488
Solder Pot and Babbit	485
Stud Welding Gun	480
Tachometer	464
Tape Measure, Diameter	475
Tool Box and Tool Bags	483
Under Cutter, Mica Miller	483
Vacuum Glass Handler	475
Weight Test Cart	476
Wire Rope Measuring Tools	477

Tools



MIS-MTR-014



MIS-MTR-050

S.E.E.S. #	O.E.M. #	Description
MIS-MTR-014	TK31A	Multi-Meter Accessory Test Kit , with carrying case. 4pc. Multi-Meter not included
MIS-MTR-015		Manual Ranging Multi Mini Meter
MIS-MTR-016		Auto Ranging Multi Mini Meter
MIS-MTR-050	24924	Flow Meter , LCD 26 GPM Flow 300 psi Max
MIS-MTR-051	24923	Flow Meter , Mechanical 32GPM 50 psi



MIS-MTR-051



MIS-216A



MIS-216B

Tachometer

The latest in micro-computer technology assures complete accuracy in measuring rotational, linear, and surface speeds. This battery operated device offers a wide speed range, large memory capacity, multi-mode speed selection, low voltage indicator, and an easy reading digital display window. Accessories included.



MIS-216

S.E.E.S. #	Description
MIS-216	Digital Handheld Tachometer , DT-105
MIS-216A	Wheel Assembly replacement for MIS-216, 6" circumference
MIS-216B	Tach Wheel 12" circumference



MIS-211



MIS-211C

Door Pressure Gauges



MIS-211E



S.E.E.S. #	O.E.M. #	Description
MIS-211		Door Pressure Gauge
MIS-211C		Door Force Gauge , SEES Door Force Measurement System
MIS-211E	475055	Digital Force Gauge , 220lbs & 980N, Measures Tension/Compression
MIS-211B	SE72142.5.25-1K	Gauge Kit , 0-1 PSI, with 1/4" NPT center back mounting

Jumper Kit

S.E.E.S. #	Description
SEES-JUMPER-001	SEES Jumper Kit , used for temporarily jumping out circuits while under repair. Jumper test lead with pouch, includes alligator clip, spring loaded plunger, lug terminal, + SEES Jumper Band
SEES-JUMPER-001F	SEES Fused Jumper Kit , Jumper test lead kit with pouch, 250V / 0.5A Glass Fuse
SEES-JUMPER-001K	SEES Jumper Kit , Test Kit with Pouch and Wrist Band
SEES-JUMPER-002	SEES Jumper , Time Out
SEES-JUMPER-003	SEES Jumper , Banana Plug 2mm x 60", Long Red 18AWG
SEES-JUMPER-004	SEES Jumper , Tip Black
SEES-JUMPER-005	SEES Jumper , Tip Red
SEES-JUMPER-006	SEES Jumper kit , 3 Gator Clips 6 Test Pins, Pouch, Wrist Band
SEES-JUMPER-007	Magnetic Jumper
SEES-JUMPER-008	Safety Labels , Bag of 25 Self Adhesive for Jumper Wires
SEES-JUMPER-009	Jumper Adapter , Bag of 4
SEES-JUMPER-BAND	Wrist Band Safety Reminder , wear while performing circuit repair, remove when job is completed and jumpers are removed. Band is marked, "No Jumper Left Behind"
SEES-JUMPER-POUCH	SEES , Jumper Pouch Only Blue with Velcro



SEES-JUMPER-001



SEES-JUMPER-BAND



SEES-JUMPER-003



SEES-JUMPER-005



SEES-JUMPER-POUCH



MIS-TOOL-150

Pumps

S.E.E.S. #	Description
MIS-TOOL-150	Dynamometer / Scale , 5,000 lbs. 5" diameter face with case
MIS-TOOL-200	Transfer Pump , 115V 5/8 inch ports, 300 GPH
MIS-TOOL-201	Ports Utility Pump , 1/2 HP, 3/4in. 115V, 100 psi

Valve Shut-Off Lever

S.E.E.S. #	Description
SEES-TOOL-001	Valve Shut-Off Lever , Dover, 12" Long



SEES-TOOL-001



MIS-TOOL-200

Voltage Detectors

S.E.E.S. #	Description
SEES-TOOL-002	Voltage Detector , with Light, No Brand
SEES-TOOL-002S	Voltage Detector , with Light, SEES Brand



SEES-TOOL-002

Hand Taps

S.E.E.S. #	Description
MIS-TOOL-120	Hand Tap , 1/4" Standard
MIS-TOOL-121	Hand Tap , 3/8" Standard
MIS-TOOL-122	Hand Tap , 5/16" Standard

Smartrise Tool

S.E.E.S. #	Description
SEES-SMARTRISE-TOOL	Smartrise Debug Tool



SEES-SMARTRISE-TOOL





SEES

FUSED JUMPER

SEES-JUMPER-001F

SAVES MONEY SAVES LIVES

Human error is inevitable and even the best of us can make a mistake once in a while. Poorly lit machine rooms, hard to reach electrical components and electrical wiring diagram errors are just a few of the contributors to these mistakes.

The **SEES fused jumper** minimizes the potential damage to technicians and elevator components.

**Replaceable fuse up to 5 amps,
1/4" glass fuse** ∨

ADVANTAGES

- » Adds an extra layer of electrical isolation/protection
- » Prevents electric shock to mechanic
- » Prevents damage to components
- » Happy technicians

STANDARD JUMPER KIT DISADVANTAGES

- » Injured technicians
- » Costly board replacement
- » Increased insurance costs
- » Angry customers
- » Downtime

» INCLUDES



Jumper Wire,
Alligator Clips



Jumper Wire,
Plunger Type



SEES Jumper,
Yellow Adaptor Pin



Velcro Pouch,
SEES Jumper Kit



SEES,
Wrist Band



Safety Labels,
Self Adhesive



SEES Inc



SEESParts

Always Smooth Sailing

2781 West McNab Rd, Pompano Beach, FL 33069 • (800) 526-0026 • www.SEESinc.com

Introducing...

THE WORLD'S BEST ELEVATOR SCREWDRIVER

\$15
FOR 1

\$12
FOR 10
OR MORE

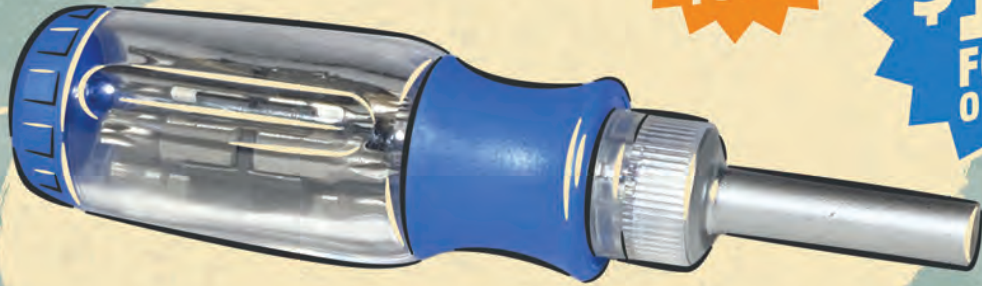

MIS-126A
*Screwdriver with
Ratchet & 12 Bits*

*Don't miss this
incredible DEAL!!!*



Phillips #0, #1, #2

Slotted #4

Spanner #6 x #8, #10 x #12

Torx(R) T10 x T15, T20 x T25



SEES Inc



SEESParts

Always Smooth Sailing

2781 West McNab Rd, Pompano Beach, FL 33069 • (800) 526-0026 • www.SEEInc.com



Hydraulic Tools

S.E.E.S.# MIS-FLT-001

Specifications

- 3/4 HP
- 10 GPM Pump
- 6 Micron Rated Filter
- Sump Strainer
- 9' Electric Cable
- 8" Hoses
- 10" Pneumatic Tires



MIS-FLT-001P



MIS-FLT-002M



MIS-FLT-007



MIS-FLT-008



MIS-FLT-009



MIS-FLT-010



MIS-FLT-R2



MIS-FLT-R1



MIS-FLT-012



MIS-FLT-R3



MIS-OIL-COOLER-001

S.E.E.S. #	Description
MIS-FLT-001	Portable Filter Cart
MIS-FLT-001P	Oil Cart Pump, Replacement
MIS-FLT-002	Kidney Loop Filtration System without mounting Kit
MIS-FLT-002M	Kidney Loop Filtration System with mounting Kit
MIS-FLT-007	Breather, Desiccant and Activated Carbon Moisture and Odor Control
MIS-FLT-008	Breather, Adapter
MIS-FLT-009	Gasket Material
MIS-FLT-010	Pressure Gauge, 2-1/2" Face, 0-600 PSI, 1/4" NPT
MIS-FLT-012	Suction Strainer, 3/4" NPT
MIS-FLT-013	Ball Valve, Low Pressure 1-1/2" Full Flow
MIS-FLT-IM284	Motor Generator Filter, 284A, 2 Cubes, 2 Panels
MIS-FLT-R1	Replacement Element Cartridge, Particle Removal, for MIS-FLT-001
MIS-FLT-R2	Replacement Element Cartridge, Water Removal, for MIS-FLT-001
MIS-FLT-R3	Particulate Removal Element
MIS-FLT-WH5014A	Filter set frame, 5014A 4 Panels
MIS-OIL-COOLER-001	Oil Cooler, hydraulic heat exchanger, 26,100 BTU/Hr Single Phase, 115/230V w/ hose, remote mount air to oil with Hydro motor and thermostat control
MIS-OIL-COOLER-003	Tank Cooler, direct mount over top of tank, requires no plumbing, 2,000 BTU/Hr, 36" x 14" x 8", auto start at 120° F
MIS-OIL-COOLER-FAN	Fan, Cooler AOC Series
MIS-OIL-COOLER-PUMP	Pump, Oil Cooler, Used on MEI's AOC and BOL

Hydraulic Tools

SEES Pressure Gauges and Adaptors

S.E.E.S. #	Description
SEES-HYD-PG	SEES pressure gauge, 1K PSI, for tanks, with ball valve
SEES-HYD-PG-001	Pressure gauge elbow adaptor, for Thyssen, fits 1/8" NPT x 1.26" OAL
SEES-HYD-PG-002	Pressure gauge elbow adaptor, for Otis, fits 1/4" NPT x 1.52" OAL
SEES-HYD-PG-003	Pressure gauge elbow adaptor, for Kone, fits 3/8" NPT x 1.76" OAL
SEES-HYD-PG-004	Pressure gauge elbow adaptor, fits 1/4" NPT x 1.81" OAL
SEES-HYD-PG-005	SEES pressure gauge adaptor kit, for Thyssen, Otis, Kone and other
SEES-HYD-PG-006	SEES pressure gauge & hose, 1K PSI, with quick connect
SEES-HYD-PG-007	SEES pressure gauge kit, all adaptors, pressure gauge and hose
SEES-HYD-PG-008	Hose Only, 3 ft with 1/4" FNPT x 1/8" MNPT
SEES-HYD-PG-009	Quick Disconnect, Female, 1/2-14 ISO 7241-1 Series B
SEES-HYD-PGP	SEES Hydro Pressure Gauge Port, quick release only
SEES-HYD-PGPF	SEES Hydro Pressure Gauge Port, Female quick release with 90 deg 1/8 elbow



SEES-HYD-PG



SEES-HYD-PG-001



SEES-HYD-PG-002



SEES-HYD-PG-003



SEES-HYD-PG-004



SEES-HYD-PG-005



SEES-HYD-PG-006



SEES-HYD-PG-007



SEES-HYD-PG-008



SEES-HYD-PGP



MIS-211B

S.E.E.S. #	O.E.M. #	Description
MIS-211B	SE72142.5.25-1K	Gauge Kit, 0-1 PSI, with 1/4" NPT center back mounting

Tools



Multi-Meter Selection Guide

S.E.E.S. #	MIS-MTR-005	MIS-MTR-001	MIS-MTR-002	MIS-MTR-003	MIS-MTR-004	MIS-MTR-006
Model	MN-26	EX-410	EX-430	EX-470	MP-530	MM-570
Key Features	Compact Size	Best value with DMM functions and features at a low cost		Infra Red Thermometer with laser	Auto ranging and RS-232 PC Interface	"Highest Precision and resolution w/ 50,000 and 500,000 counts"

Special Functions

Basic Accuracy (VDC)	1%	0.50%	0.30%	0.30%	0.08%	0.02%
Temperature (Type K)	*	*	*	*	*	*
Temperature (InfraRed)				*		
Capacitance	*		*	*	*	*
Frequency	*		*	*	*	*
Logic Test						
Transistor						
Battery Test						
Signal Output						
Duty Cycle	*		*	*		*
Pulse/Period Width						

Features

True RMS			*	*	*	*
Autoranging	*		*	*	*	*
Counts	4000	2000	4000	4000	5000	50,000/500,000
Backlit Display		*	*	*	*	*
Data Hold	*	*	*	*	*	*
Auto Power Off	*	*	*	*	*	*
Bargraph					*	*
Relative	*		*	*	*	*
Peak Hold					*	*
Min/Max					*	*
Input Alert		*	*	*		
Data logging						
PC Interface					*	*
Software					OPTIONAL	OPTIONAL
Category Rating	CAT II 600V	CAT III 600V	CAT III 600V	CAT III 600V	CAT III 600V	CAT III 600V
CE/UL	CE/UL	CE/UL	CE/UL	CE/UL	CE/UL	CE/UL
Warranty	1 YEAR	1 YEAR	3 YEARS	3 YEARS	3 YEARS	3 YEARS

Tools

EXTECH
INSTRUMENTS



AC/DC Clamp on Meters

S.E.E.S. # MIS-MTR-008

Features:

- Maximum AC current of 600A
- Measure AC Current, AC/DC Voltage and Resistance
- Data Hold "freezes" data in display
- 1.25" (33mm) circular jaw opening for large cables (350MCM)
- Peak Hold captures in-rush currents
- Audible Continuity beeper
- Auto power off
- Complete with test leads, 9V battery, and carrying case
- True RMS voltage and current measurements
- AC/DC current to 600A
- Large 4000 count LCD display
- Capacitance measurements
- Temperature measurements
- Includes temperature probe

Specifications:

AC Current: 400A, 600A (Trms) (100mA)
 DC Current: 400A, 600A (100mA)
 DC Voltage: 400mV, 4V, 40V, 400V, 600V (0.1mV)
 AC Voltage: 4V, 40V, 400V, 600V (Trms) (1mV)
 Resistance: 400Ω, 4kΩ, 40kΩ, 400kΩ, 4MΩ, 40MΩ (0.1Ω)
 Capacitance: 40nF, 400nF, 4μF, 40μF, 100μF (0.01nF)
 Temperature: -4 to 1400°F, -20 to 760°C (1°F/°C)
 Continuity: yes
 Power: 9V battery
 Dimensions: 3.1 x 8 x 1.6" (79 x 203 x 41mm)
 Weight: 6.5oz (185g)

Basic Accuracy (%rdg+digits)

±(3.5% + 5d)
 ±(3.5% + 3d)
 ±(0.5% + 2d)
 ±(0.8% + 3d)
 ±(1% + 4d)
 ±(3.5% + 5d)
 ±(3.0% + 3°F/°C)

S.E.E.S. # MIS-MTR-009

Features:

- Full function auto ranging DMM includes AC/DC Voltage and Current, Resistance, Capacitance, Frequency, Duty Cycle, Diode and Continuity
- Current measurements to 2000A through the clamp and 240mA via test leads
- Large 5000 count backlit display for high resolution and easy viewing in dimly lit areas
- Basic DCV accuracy of 1% with 0.1mV resolution and current resolution to 0.1μA
- Rugged 2.36" jaws accommodate one 2000MCM or two 500MCM cables
- Features include DCA push button zero, Relative measurements and Data Hold
- Heavy duty ABS case with built-in stand and thumb control function switch
- Complete with test leads and 9V battery

Specifications Ranges Max. Resolution Basic Accuracy (%rdg+digits)

DC/AC Current (Clamp): 240A, 2000A 0.1A ±(2% + 5d)
 DC/AC Current (DMM): 240μA, 2400μA, 24mA, 240mA 0.1μA ±(1.2% + 5d)
 DC Voltage: 240mV, 2.4V, 24V, 240V, 1000V 0.1mV ±(1% + 2d)
 AC Voltage: 2.4V, 24V, 240V, 1000V 1mV ±(1.2% + 5d)
 Capacitance: 25nF, 250nF, 2.5μF, 25μF 0.01μF ±(3% + 5d)
 Resistance: 240Ω, 2.4kΩ, 24kΩ, 240kΩ, 2.4MΩ, 24MΩ 0.1Ω ±(1% + 5d)
 Frequency: 50Hz, 500Hz, 5kHz, 50kHz, 100kHz 0.001Hz ±(1% + 5d)
 Duty Cycle: 0.1% to 99.9% 0.1% ±(1% + 5d)
 Diode Check: yes
 Continuity: yes
 Dimensions/Weight: 10 x 2.9 x 1.5" (255 x 73 x 38mm)/14oz. (380g)

Tools

Special Purpose Meters



EXTECH
INSTRUMENTS



S.E.E.S. # MIS-MTR-010

Wide Range Infrared Thermometer

Non-contact Infrared Thermometer with laser pointer measures to 1000°F

Features:

- Wide range temperature measurements from -54°F to 1000°F without contact
- Large LCD display with backlighting
- Built-in laser pointer to improve aim
- °F/°C switchable
- Fixed emissivity (0.95) covers 90% of surface applications
- Narrow field of view
- Audible and visible overrange indicators
- Automatic Data Hold

Applications:

- Measure surface temperature of objects which are difficult to reach or unsafe to contact
- Measure hot spots in electrical panels and equipment
- In-process temperature measurements

Specifications:

Range:	-58 to 1000°F or -50 to 538°C
Accuracy:	±2% of reading or ±4°F/ 2°C (whichever is greater)
Resolution:	0.1°F/°C
Emissivity:	0.95 fixed
Display:	Backlit LCD
Power:	9V battery
Field of view:	8:1 (at 8" distance measure 1" target)
Dimensions:	8.3 x 3.5 x 1.5" (211 x 89 x 38mm)
Weight:	6.4oz. (200g)

S.E.E.S. # MIS-MTR-011

Digital Sound Level Meter

Big Display, RS-232 interface, and Background Noise Absorber

Features:

- Auto/Manual ranging from 30 to 130dB in 6 ranges
- Meets ANSI and IEC Type 2 standards
- A and C selectable frequency weightings
- Fast and Slow selectable response times
- Background noise absorber mode for machine noise measurements filters ambient noise
- Large 3 1/2 digit display with 0.1dB resolution with backlighting and analog bar graph
- Electret condenser microphone provides 1.5dB accuracy
- Min/Max plus analog output and tripod mount
- Max Hold latches maximum value on display
- RS-232 interface for capturing data directly on a PC, optional Windows® compatible software
- Complete with batteries and carrying case

Applications:

- Machine noise evaluation
- OSHA compliance testing
- Community noise measurement
- Noise ordinance
- PC interface for data collection

Digital Display:	3-1/2 digit (1999 count) Autorange LCD
Bargraph Display:	50dB display range (1dB resolution);
Measurement Range:	30 to 130dB (35 to 130dB for "C" weighting)
Resolution:	0.1dB
Accuracy:	±1.5 dB @ 94dB for a 1kHz sine wave
Microphone:	Electret Condensator .24" (6mm dia.) type
Frequency Weighting:	"A" and "C" type
Time Response:	Slow/Fast
Sampling time:	updates every 0.5 seconds
Measurement frequency range:	31.5Hz to 8KHz
Analog output:	AC: 0.707Vrms (full scale); DC: 10mVDC/dB
Applicable Standards:	IEC 651 Type 2, ANSI S1.4 Type 2
Power Supply:	9V battery, optional AC adaptor
Dimensions:	10 x 3.1 x 1.5" (256 x 80 x 38mm)
Weight:	8.5oz. (240g)

Tools

Special Purpose Meters



S.E.E.S. # MIS-MTR-011A

Digital Sound Level Meter

30-130dB(A) Range with Sound Simulation, Max/Min/Data Hold, Fast/Slow Mode, Self-Calibration Noise Meter

Features:

- Frequency weighting: A
- Frequency response: 31.5Hz — 8KHz
- Level ranges: 30dB 130dB (resolution: 0.1dB)
- Response time: (FAST)125ms,(SLOW)1000ms
- Overload indication: 30dB (UN display), 130dB (OL display)
- Accuracy: ± 1.5 dB (@1KHz Standard source)
- Auto power off: Auto shut down after approx 10 minutes of inactivity
- Low battery indication: 6V
- Sensor: 1/2 inch electret condenser microphone

Applications:

- Machine noise evaluation
- OSHA compliance testing
- Community noise measurement
- Noise ordinance
- PC interface for data collection

Measurement Range: 30 to 130dB (35 to 130dB for "C" weighting)
 Resolution: 0.1dB
 Accuracy: ± 1.5 dB @ 94dB for a 1kHz sine wave
 Microphone: Electret Condensor .24" (6mm dia.) type
 Frequency Weighting: "A" and "C" type
 Time Response: Slow/Fast
 Sampling time: updates every 0.5 seconds
 Measurement frequency range: 31.5Hz to 8KHz
 Analog output: AC: 0.707Vrms (full scale);
 DC: 10mVDC/dB
 Power Supply: 9V battery
 Dimensions: 2.12 x 7.48 x 1.38 "
 Weight: 6oz. (170g)



S.E.E.S. # MIS-MTR-012

Combination Tachometer

Battery operated non-contact motion and RPM measurements

Features:

- Unique display where characters reverse direction depending on measurement mode you are in
- Large 0.4" 5 digit LCD digital display
- Microprocessor based with quartz crystal oscillator to maintain high accuracy
- Tachometer memory stores last, max and min readings
- Provides wide RPM (photo) and Linear Surface Speed (contact) measurements
- Microprocessor precision, accurate to 0.05%
- Permits readings to a resolution of 0.1 RPM in either photo or contact mode
- Complete with wheels for linear surface speed or RPM measurements, four 1.5 volt AA batteries, reflective tape and carrying case

Applications:

- Contact RPM Measurements for flywheels, conveyors, pumps and elevators
- Non-Contact RPM measurements for fans, motors & gears

Specifications Ranges Basic Accuracy Range (RPM): 5 to 99,999 0.5 to 20,000

Accuracy: 0.05% of reading +1 digit
 Sampling Time: 1 Sec > 60 RPM 1 Sec > 6 RPM
 Surface Speed: 0.2 to 6560 ft/min 0.05 to 1999.9m/min
 Resolution: 0.1 RPM (< 1,000 RPM) 1 RPM >1000 RPM
 Power: 4 AA batteries
 Dimensions: 8.5 x 2.6 x 1.5" (215 x 65 x 38 mm)
 Weight: 10.6 oz (300 g)

Tools
EXTECH
INSTRUMENTS



MIS-MTR-032



MIS-MTR-034



MIS-MTR-035



MIS-MTR-036

Special Purpose Meters

S.E.E.S. # MIS-MTR-032

Photo Thermal Imaging Infrared Camera

Features:

- Pocket sized and fully automatic design makes it incredibly easy-to-use even for first time users--perfect for general purpose use
- 80 x 80 pixels for clear images
- Focus Free Lens
- 5 hour battery life
- 2.8" color LCD
- Only 12oz.
- Included memory card stores up to 500+ Radiometric JPEG images. Each image can be analysed using the included software.

Specifications :

Temperature range: 32 to 482°F
Resolution: 80 x 80 pixels
Accuracy: 2%
Thermal Sensitivity: 0.1°C

S.E.E.S. # MIS-MTR-033

Temperature/Humidity Wall Meter

Features:

- Min/Max reset
- 1 AAA Battery
- 1" Digits on large LCD
- Low battery indication
- Complete with built-in tilt stand, wall mounting bracket, and 1.5V AAA battery



MIS-MTR-033

S.E.E.S. # MIS-MTR-034

Meter, Light Measurement Up To 20,000Fc/20,000Lux

Features:

- Compact and rugged design with large display
- Low range model measures to 2,000Fc/ 20,000Lux
- Data Hold and Min/Max readings
- Auto power off

S.E.E.S. # MIS-MTR-035

Multimeter Adaptor, Ft Candle Light, ranges (0 to 5000Fc)

Features:

- A low cost alternative to a full size meter with display - simply plug into your multimeter for direct measurements in Foot candles
- Three measurement ranges (0 to 5,000Fc) with 5% accuracy
- 1mV/Fc output

S.E.E.S. # MIS-MTR-036

Light Meter, Foot Candle/Lux Incl Analog Output

Features:

- Accurately displays light level in terms of Fc or Lux over three ranges
- Select fast (1 second) or slow (2 seconds) response time
- Analog output of 1mV per count for capturing readings to a recorder

Tools

Door Wedge Tools

Safely perform maintenance and repair services with SEES series of door wedge tools

S.E.E.S. #	O.E.M. #	Description
DW-T00L		Door wedge tool
MIS-DW-T1	SAF165	Tool, Door Wedge with Knob and fire tab slots
MIS-DW-T2	SAF164	Tool, Door Wedge with Knob standard without slot
MIS-DW-T3	10-851	Door Wedge Tool, with Knob, narrow door stop, 3/8" W
SEES-DWT-001		SEES Door Wedge Tool, Blue Poly
SEES-DWT-002		SEES Door Wedge Tool, Black Poly
SEES-DWT-002MR		SEES Door Wedge Tool, Metric, Rubber 70 Duro no slot
SEES-DWT-003		SEES Door Wedge Tool, Blue Poly with fire tab slot
SEES-DWT-004		SEES Door Wedge Tool, Black Poly with fire tab slot
SEES-DWT-004R		SEES Door Wedge Tool, Rubber 70 Duro with fire tab slot
SEES-DWT-005		SEES Spring Door Wedge Tool, Rubber Coated Spring Steel
SEES-DWT-006		SEES Door Wedge Tool, Stainless Steel Bottle Opener
DG-MT		Door Gap, Measuring tool



Steel Diameter Measuring Tape

S.E.E.S. #	Description
MIS-165	Steel Measuring Tape for measuring the diameter of pistons or shafts. One side of this handy tape is an inch measurement and the other side inches of diameter by 64ths. Used to measure the circumference of pistons.



Lamp and Fuse Removers

S.E.E.S. #	Description
MIS-175	Bulb Remover, a useful aid in removing all types of lamps from hard to reach lamp sockets.
FM-100	Fuse Puller Specialty Tool for easy fuse removal and replacement
MIS-223	Yellow stick, insulated wire puller
MIS-223A	Orange stick, original, 7" long, 160 dia., 10 pack, wood



Door Sill Cleaning Brush

S.E.E.S. #	Description
MIS-158	Door sill cleaning brush, heavy duty wire brush with wooden handle. It is the perfect tool for many jobs.



Vacuum Glass Handler

S.E.E.S. #	Description
MIS-220	Vacuum Glass Handler Super grip double 5" diameter vacuum cups to safely handle glass, 75lb Capacity
MIS-220A	Vacuum Cup Lifter, 5" Dia Dual Cups, 150lb Capacity





MIS-118



MIS-118A



MIS-118B



30334008



MIS-LOCK-001



SEES-WC-002W



SEES-WC-002WB



SEES-WC-002

Rail Blocks

S.E.E.S. #	Description
KOOL-RGB-001	Rail Guide Block, Brake Assembly with Inserts
KOOL-RGB-001A	Rail Guide Block, Replacement Pad. M12, Old Design Heat Treated
KOOL-RGB-001B	Rail Guide Block, Replacement Pad. M12, New Design Heat Treated
KOOL-RGB-001M	Rail Guide Block, Magnet 3/4" O.D. x 1/2" TK
KOOL-RGB-002	Rail Guide Block, Remblok 30mm, Standard
KOOL-RGB-002A	Rail Guide Block, Remblok 30mm
KOOL-RGB-003	Rail Guide Block, Remblok 40mm, Standard
KOOL-RGB-004	Rail Guide Block, Pivot Block Serrated
MIS-118	Tool, Rail blocks for 5/8" rail, 25,000 lb rating/pair
MIS-118A	Tool, Rail blocks for 5/8" rail with clevis (25,000lb/pair)
MIS-118B	Replacement Set Screws, for Rail Blocks, (Set of 6)

Ground Fault Protection

S.E.E.S. #	Description
30334008	GFCI Plug, right angle, with triple tap 2 ft.
30334052	GFCI, right angle, protected quad outlet box
30338018	GFCI, in-line cord set 18"
30338024	GFCI, in-line with triple tap 3 ft
30339005	Adapter, 3-wire outlet



30334052



30338018



30338024



30339005

Lock Out Tools

S.E.E.S. #	Description
MIS-LOCK-001	Lock Out, for Switch 1-1/2" Shk Master Red K/A, with key #600F41
MIS-LOCK-001A	Key, #600F41 Replacement for MIS-LOCK-001

Weight Test Cart

S.E.E.S. #	Description
SEES-WC-002	SEES Weight Test Cart, 500lbs
SEES-WC-002-RENTAL-D	SEES Weight Test Cart, 500lbs Daily Rental
SEES-WC-002-RENTAL-W	SEES Weight Test Cart, 500lbs Weekly Rental
SEES-WC-002-RENTAL-M	SEES Weight Test Cart, 500lbs Monthly Rental
SEES-WC-002W	Weight Cart Wheel, replacements
SEES-WC-002WB	Weight Cart Wheel Bushing, replacements
SEES-WC-003	Weights, 50lb casting
SEES-WC-004	SEES Weight Test Cart, 250lbs

Tools

S.E.E.S. #	Description
MIS-108	Cable Jacket Remover precision shears ease the removal of plastic, metal and rubber jacket from all round cables. Smooth positive cutting action.
MIS-108-A	Blade Nose Guide , replacement
MIS-108-B	Cutter Blades , replacement, 6/Pkg
MIS-109	Inspection Mirror , 1-1/8" diameter magnifying mirror has a 1/4" diameter handle that is set on a 45° angle.
MIS-111	Contact Burnishing Tools , 3" x 1/4" x .007" thick. Leaves no residue, insulated plastic handle, 5/pkg.
MIS-112	Contact Burnishers , Heavy-Duty 3-1/4" x 1/4" x .010" thick. Leaves no residue, insulated plastic handle, 5/Pkg.
MIS-050	Flex Rail File , 14" Flat Flex Rail File, 8 teeth per inch
MIS-050B	File Handle , Adj. heavy-duty metal plane type 12-14
MIS-113	Spring Adjuster with Offset .018"
MIS-114	Spring Adjuster with Offset .032"
MIS-115	Adjuster Tool , .40" and .028" slots
MIS-TOOL-003	Step Drill Bits , high speed steel, 10 hole sizes range from minimum 13/16" to maximum 1-3/8". Shank size 7/16"
MIS-TOOL-202	Sill Height Gauge , Imperial Slider Ruler
MIS-TOOL-202M	Sill Height Gauge , Metric Slider Ruler
MIS-TOOL-203	Sill Height Gauge , Imperial, S/S Slider
MIS-TOOL-203M	Sill Height Gauge , Metric, S/S Slider
WR-SJ-001	Wire Rope Soft Jaws , for use with vice grips (not included)
MIS-211D	Gauge , Wire Rope Tension
WR-MT	Wire Rope Measuring Gauge , for imperial sizes, go/no go style, use on rope diameters 3/8", 7/16", 1/2", 9/16", 5/8", 11/16" and 3/4". Blue anodized with SEES logo
WR-MT-ATIS	Wire Rope Measuring Tool , for imperial sizes, Marked with ATIS logo, Blue
WR-MT-NB	Wire Rope Measuring Tool , blue anodized without logo
WR-MT-METRIC	Wire Rope Measuring Tool for Metric Rope, measure rope diameter, go / no go. Blue anodized.
SEES-WR-SG	Wire Rope Sheave Gauge , (Metal) Sizes: 1/2, 9/16, 5/8, 3/4
SEES-WS-001	SEES Wire Stripper Tool
MIS-TOOL-008	Snap Ring Pliers Set , Internal & External



MIS-108



MIS-108-A



MIS-108-B



MIS-109



MIS-111



MIS-050



MIS-050B

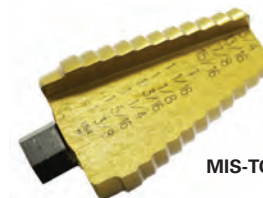

MIS-TOOL-003



MIS-114



MIS-115



MIS-TOOL-202

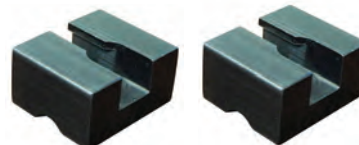

WR-SJ-001



SEES-WS-001



MIS-211D



WR-MT



WR-MT-NB



WR-MT-METRIC

Tools



WR-CALIPER



WR-CALIPER-C



WR-CALIPER-L



G-TOOL-001



G-TOOL-002



MIS-TOOL-001



MIS-TOOL-004



MIS-TOOL-005



MIS-TOOL-006



MIS-TOOL-007



MIS-920



MIS-921



MIS-922

S.E.E.S. #	O.E.M. #	Description
WR-CALIPER		Digital Wire Rope Caliper , only
WR-CALIPER-C		Wire Rope Caliper , with case, digital, measures inches and millimeters
WR-CALIPER-L		Wire Rope Caliper , Digital Digital 6" in/mm, Larger Jaw
G-TOOL-001	DRV-0009N	Parameter Tool , for MOVFR II Hand Held with 7FT Cable
G-TOOL-002	DRV-0003N	Parameter Tool , FR-PU04-7 Hand Held with 7FT Cable
G-TOOL-003	2500-3051	Parameter Tool , for MOVFE
GPC-201	MOVFR-0072N	Drive , 115 VAC for MOVFR II Oper Includes Drive Ribbon Cable
SEES-CABLE-USB-RJ45		Programming Cable , USB to RJ45
MIS-TOOL-001		Flashlight , 9 LED, extra bright, with SEES logo
MIS-TOOL-004	EMF-1	Flashlight , Extendable LED 6-21" with Magnetic Tip
MIS-TOOL-005	EMF-2	Flashlight , Extendable Magnetic LED 21" including inspection mirror & clip
MIS-TOOL-006	MSL-1	Stick Light , Magnetic LED Water Resistant, with AAA Battery
MIS-TOOL-007	PAL-1	Area Light , Pocket Size LED Water Resistant, with AAA Battery
MIS-TOOL-010		Swaging Tool , 24" Hand Swager For Wire Rope Aircraft Cable
MIS-TOOL-011	PJL-1	Portable Light , 10W COB LED, Cordless, Magnetic
MIS-147B-P	9875412	Car Top Light , magnetic base with flex neck & 25ft cord with plug
MIS-920		Drop Light , Fluorescent Work Light 120V 25' Cord with Outlet
MIS-921		Drop Light , Fluorescent Work Light 15W 25' Cord with 100V Tool Tap
MIS-922		Drop Light , Fluorescent Work Light 15W 50' Cord with 100V Tool Tap
LTT-1		Service Tool , LG Sigma OPP-2000
LTT-2		Service Tool , LG Sigma OPP-2000
SEES-BRGT-001	BTM-100	Bearing Removal Tool , for 1604 drive arm bearings

Relay Testers

Universal Multi-Volt Relay Tester



S.E.E.S. #	Description
MIS-301UTK ■ Boards included, MIS-301UT1, MIS-301UT2, MIS-301UT4, MIS-301UT5, MIS-UT6, MIS-UT7 and MIS-UT11	Tester Kit , Universal multi-volt relay tester with lamp test fixture and carrying case. Tests 2-12 pole relays including the following: P&B R1 relays, KU Series 2 and 3 pole relays, Omron MY/LY relays, Houghton 6 pole relays, IBM relaysm Input/Output modules
MIS-301UT	Relay Tester , universal, with case, AC/DCV boards sold separately or in a kit
MIS-301UT1	Relay , P&B R1- series
MIS-301UT2	Relay , KU series 2/3 pole
MIS-301UT3	Board , lamp test
MIS-301UT4	Relay , Omron MY type, 2/4 pole
MIS-301UT5	Relay , Omron LY type, 2 pole
MIS-301UT6	Relay , HRP-4BB/4BA
MIS-301UT7	Relay , IBM 4-12PDT, 45 VDC
MIS-301UT8	Relay , solid state, plug in
MIS-301UT9	Relay Test Board , I/O module for DRP-22 and DRP-22A
MIS-301UT10	Relay Test Board , I/O module for DRP-22H, DRP-22C, DRP-22F
MIS-301UT11	Relay Test Board , I/O module for DRP-22B & DRP-22G
MIS-301UT12	Relay Test Board , LY4N relay tester
MIS-301UT13	Test Board , Motion Control 100 VDC Safety Relay
MIS-301UT14	Test Board , for PR-36, 37 & PR-52 Guardian type relays
MIS-301UTF	Main Fuse , SEES relay tester 500MA
MIS-301UTF-C	Coil Fuse , SEES relay tester 250MA
MIS-301UT-IBM	IBM Tester kit , MIS-301UT with IBM test card



MIS-301UT Includes Case



MIS-301UTF-C MIS-301UTF



MIS-301UT-IBM



MIS-301UT1

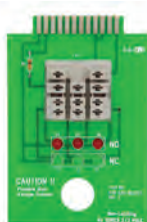

MIS-301UT2



MIS-301UT3



MIS-301UT4

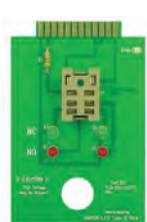

MIS-301UT5



MIS-301UT6



MIS-301UT7



MIS-301UT8



MIS-301UT10

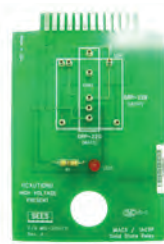

MIS-301UT11



MIS-301UT12



MIS-301UT13



MIS-301T

Specialty Test Equipment

S.E.E.S. #	O.E.M. #	Description
MIS-300T		Relay tester . Hall effect, non contact LED relay tester. Ideal for "ice cube" relays. Works with all voltages and currents.
MIS-301T		Universal Relay Tester . For IBM style relays.
MIS-310		EEPROM Memory Copier
MIS-311		EEPROM Eraser with Timer
MIS-312	A835RPLBOX	PCB , EDR assembly with box



MIS-300T

Tools

Relay Adjuster's Tool Kit

Specially designed tools are a must for the technician or adjuster. The perfect assortment to quickly and efficiently check, adjust and trouble-shoot all types of relays, held in a strong vinyl case with pockets.



MIS-116

S.E.E.S. #	Description
MIS-116	Relay Service Tool Kit , Vinyl case contains: Thickness gauges, a spring tension gauge, contact burnishers, spring and armature adjusters, flat nose pliers, phillips screw driver, offset screwdrivers, inspection mirror, wrenches and a screw holding screwdriver.

Stud Welding Gun

S.E.E.S. #	Description
MIS-SWG-1	Stud Welding Gun , Gap gun G-1 with 10' cable
MIS-SWG-2	Stud Welding Gun , Contact gun C-1 with 10' cable
MIS-SWG-3	Stud Welding Gun , S-1 gun extended pistol with 15' cable
MIS-SWG-TIP-8	Stud Welding Tip , #8 Stud
MIS-SWK-1	Stud Welder Kit , Quickshot 1/4 capacity, specify gun
MIS-SWK-2	Stud Welder Kit , Modular 5/16" capacity, specify gun
MIS-SWK-3	Stud Welder Kit , Titan 3/8" capacity, specify gun
MIS-SWST-0610	Stud Welder Kit , Titan 3/8" capacity, specify gun
MIS-SWST-0650	Welding Stud , 6-32 x 0.50", Pack of 100
MIS-SWST-0810	Stud Welder Kit , Titan 3/8" capacity, specify gun
MIS-SWST-0850	Welding Stud , 8-32 x 0.50", Pack of 100
MIS-SWST-08075	Welding Stud , 8-32 x 0.75", Pack of 100
MIS-SWST-1010	Stud Welder Kit , Titan 3/8" capacity, specify gun



MIS-SWG-2



MIS-SWK-1

Commutator Treating Kit and Stone

This versatile tool is a must. Each kit contains an assortment of specialized stones and a flexible handle. Completely non-conductive for safe use.

S.E.E.S. #	Description
MIS-135	Commutator Treating Kit and brush seater contains a holder, and two each coarse, medium, finish, and extra finish stones, and four brush seater and seating stones.
MIS-136	Handle Only , for seating stones
MIS-137	Replacement Stone , Grade: Coarse, Red
MIS-138	Replacement Stone , Grade: Medium, Yellow
MIS-139	Replacement Stone , Grade: Finish, Green
MIS-140	Replacement Stone , Grade: Extra Finish, Black
MIS-141	Replacement Stone , Grade: FH Seater, White
MIS-186A	Brush Seater and Commutator Cleaning Stones . This popular Medium-Soft Grade stone, 1" x 1" x 4-3/4" long, is perfect for general purpose use. Additional sizes and grades also available each sold separately
MIS-186F	Commutator Eraser , 1" x 1" x 5" Rubrite flexible abrasive cleaning tool for commutator conditioning. Required for proper maintenance of generators and DC motors.



MIS-135



MIS-186A

Brush Seater

S.E.E.S. #	Description	L	W	H	Grade
MBS-001	Brush Seater , cleaning stones (pack of 1)	4-3/4"	2"	1-1/4"	MS
MBS-002	Brush Seater , cleaning stones (pack of 1)	4-3/4"	1"	1/2"	MS
MBS-003	Brush Seater , cleaning stones (pack of 1)	4-3/4"	3/4"	1/2"	MS
MBS-004	Brush Seater , cleaning stones (pack of 2)	4-3/4"	3/4"	1/4"	FH
MBS-005	Brush Seater , cleaning stones (pack of 4)	4-3/4"	1/2"	1/4"	FH
MBS-006	Brush Seater , cleaning stones (pack of 4)	4-3/4"	3/8"	1/4"	FH



MBS SERIES

Tools

Burnishing Tools

Designed to burnish and polish all types of contacts -- without removing virtually any precious metal. And they leave no grit.

S.E.E.S. #	Description	L	W	T	Pack
MBT-001	Burnishing Tool, Contact, plastic handle	4"	3/16"	.007"	12
MBT-002	Burnishing Tool, Contact, plastic handle	4"	3/16"	.007"	10
MBT-003	Burnishing Tool, Contact, plastic handle	3-1/2"	1/4"	.011"	10

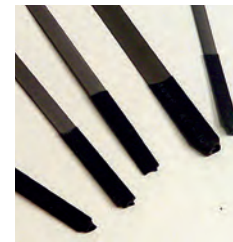

MBT SERIES

Commutator Dressing and Finishing Stones

Commstone, Lathe-Type

S.E.E.S. #	Description	L	W	H	Grade
MCS-001	Commstone, Lathe-type w/ 1-1/2 wood block	5"	1"	1-1/2"	EP
MCS-002	Commstone, Lathe-type w/ 1-1/2 wood block	5"	1"	1-1/2"	F
MCS-003	Commstone, Lathe-type w/ 1-1/2 wood block	5"	1"	1-1/2"	M
MCS-004	Commstone, Lathe-type w/ 1-1/2 wood block	5"	1"	1-1/2"	P
MCS-005	Commstone, Lathe-type w/ 3 wood block	8"	1"	2"	F
MCS-006	Commstone, Lathe-type w/ 3 wood block	8"	1"	2"	M
MCS-007	Commstone, Lathe-type w/ 3 wood block	8"	1"	2"	P
MCS-008	Commstone, Lathe-type w/ 3 wood block	8"	1"	2"	EP
MCS-009	Commstone, Lathe-type no wood block	8"	1"	2"	EP
MCS-010	Commstone, Lathe-type w/ 1-1/2 wood block	8"	1"	1-1/2"	F
MCS-011	Commstone, Lathe-type w/ 1-1/2 wood block	8"	1"	1-1/2"	M
MCS-012	Commstone, Lathe-type w/ 1-1/2 wood block	8"	1"	1-1/2"	P
MCS-013	Commstone, Lathe-type w/ 1-1/2 wood block	8"	1"	1-1/2"	EP
MCS-014	Commstone, Lathe-type w/ 3 wood block	8"	1-1/2"	2-1/2"	EP
MCS-015	Commstone, Lathe-type w/ 3 wood block	8"	1-1/2"	2-1/2"	F
MCS-016	Commstone, Lathe-type w/ 3 wood block	8"	1-1/2"	2-1/2"	M
MCS-017	Commstone, Lathe-type w/ 3 wood block	8"	1-1/2"	2-1/2"	P



MCS SERIES

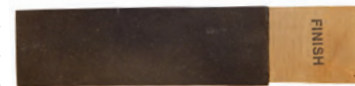

MCS-015



MCSP SERIES

Commstone, Pencil-Type

S.E.E.S. #	Description	L	W	H	Grade
MCSP-001	Commstone, Pencil-type	6"	3/8"	1/4"	F
MCSP-002	Commstone, Pencil-type	6"	3/8"	1/4"	M
MCSP-003	Commstone, Pencil-type	6"	3/8"	1/4"	P
MCSP-004	Commstone, Pencil-type	6"	3/8"	1/4"	EP
MCSP-005	Commstone, Pencil-type	6"	1/2"	1/4"	M
MCSP-006	Commstone, Pencil-type	6"	1/2"	1/4"	P
MCSP-007	Commstone, Pencil-type	6"	3/8"	3/8"	F
MCSP-008	Commstone, Pencil-type	6"	3/8"	3/8"	M
MCSP-009	Commstone, Pencil-type	6"	3/8"	3/8"	P
MCSP-010	Commstone, Pencil-type	6"	3/8"	3/8"	EP
MCSP-011	Commstone, Pencil-type	6"	1/2"	3/8"	F
MCSP-012	Commstone, Pencil-type	6"	1/2"	3/8"	M
MCSP-013	Commstone, Pencil-type	6"	1/2"	3/8"	P
MCSP-014	Commstone, Pencil-type	6"	5/8"	1/2"	F
MCSP-015	Commstone, Pencil-type	6"	5/8"	1/2"	M
MCSP-016	Commstone, Pencil-type	6"	5/8"	1/2"	P
MCSP-017	Commstone, Pencil-type	6"	3/4"	3/4"	EP
MCSP-018	Commstone, Pencil-type	6"	3/4"	3/4"	M
MCSP-019	Commstone, Pencil-type	6"	3/4"	3/4"	F
MCSP-020	Commstone, Pencil-type	6"	3/4"	3/4"	P
MCSP-021	Commstone, pocket combination	8"	2"	1"	M/P

Grade Guide

GRADE M (Medium - 90 Grit) for use where only high mica or a small amount of copper is to be removed.

GRADE F (Fine - 120 Grit) recommended for general finishing, for periodic preventative maintenance or removing small ridges.

GRADE P (Extra Fine or Polishing - 220 Grit) for finishing or polishing / burnishing where a high mirror-like polish is desired.

GRADE EP (Extra Polish - 320 Grit) for finishing small commutators.



MCSP-002

Tools



MFFP SERIES

Grade Guide

80	Coarse
120	Medium
180	Fine
240	Extra Fine
320	Polish



MRR SERIES

Flexible Files

Plastone flexible files are made of hard abrasive materials pressed into a flexible core to enable you to bend or twist these tools any way you like to reach curved surfaces and otherwise hard-to-reach areas. They are non-conductive and impervious to oil and water.

S.E.E.S. #	Description	L	W	H	Grade
MFFP-001	Flexible File, Plastone 12/pack	1/4"	4-1/2"	.015"	240
MFFP-002	Flexible File, Plastone 12/pack	3/8"	4-1/2"	.015"	240
MFFP-003	Flexible File, Plastone 12/pack	1/4"	4-1/2"	.015"	320
MFFP-004	Flexible File, Plastone 12/pack	3/8"	4-3/4"	.015"	320
MFFP-005	Flexible File, Plastone 12/pack	3/8"	4-3/4"	.025"	120
MFFP-006	Flexible File, Plastone 12/pack	1/4"	4-1/2"	.020"	240
MFFP-007	Flexible File, Plastone 12/pack	3/8"	4-1/2"	.020"	240
MFFP-008	Flexible File, Plastone 12/pack	1/4"	4-1/2"	.020"	320
MFFP-010	Flexible File, Plastone 12/pack	3/8"	4-1/2"	.040"	180
MFFP-011	Flexible File, Plastone 12/pack	1/4"	4-1/2"	.040"	240
MFFP-012	Flexible File, Plastone 12/pack	3/8"	4-1/2"	.040"	240
MFFP-013	Flexible File, Plastone 12/pack	1/4"	4-1/2"	.040"	320
MFFP-014	Flexible File, Plastone 12/pack	3/8"	4-1/2"	.040"	320
MIS-186	Flexible File, Plastone 12/pack	3/8"	4-3/4"	.040"	80
MIS-185	Flexible File, Plastone 12/pack	1/2"	4-3/4"	.020"	180
MIS-185A	Flexible File, Plastone 12/pack	1/2"	4-3/4"	.040"	80
MIS-186B	Flexible File, Plastone 12/pack	1/2"	4-3/4"	.040"	120
MFFP-019	Flexible File, Plastone 12/pack	1/2"	4-3/4"	.040"	180
MFFP-020	Flexible File, Plastone 12/pack	1/2"	4-3/4"	.040"	240
MFFP-021	Flexible File, Plastone 12/pack	7/8"	4-3/4"	.040"	120
MFFP-022	Flexible File, Plastone 12/pack	7/8"	4-3/4"	.040"	240
MFFP-023	Flexible File, Plastone 12/pack	7/8"	4-3/4"	.040"	320
MIS-186C	Flexible File, Plastone 12/pack	7/8"	4-3/4"	.070"	80
MIS-186D	Flexible File, Plastone 12/pack	1/2"	4-3/4"	.070"	80
MIS-186E	Flexible File, Plastone 12/pack	1/2"	4-3/4"	.070"	120
MFFP-026	Flexible File, Plastone 12/pack	1/2"	4-3/4"	.070"	120
MFFP-027	Flexible File, Plastone 12/pack	1/2"	4-3/4"	.070"	240
MFFP-028	Flexible File, Plastone 12/pack	1/2"	4-3/4"	.070"	320
MFFP-029	Flexible File, Plastone 12/pack	3/8"	4-3/4"	.070"	120
MFFP-030	Flexible File, Plastone 12/pack	3/8"	4-3/4"	.070"	180
MFFP-031	Flexible File, Plastone 12/pack	3/8"	4-3/4"	.070"	320
MFFP-032	Flexible File, Plastone 12/pack	7/8"	4-3/4"	.070"	80
MFFP-033	Flexible File, Plastone 12/pack	7/8"	4-3/4"	.070"	180
MFFP-034	Flexible File, Plastone 12/pack	7/8"	4-3/4"	.070"	120
MFFP-035	Flexible File, Plastone 12/pack	1/8"	4-1/2"	.020"	240
MFFP-036	Flexible File, Plastone 12/pack	1/8"	4-1/2"	.020"	320
MFFP-037	Flexible File, Plastone 12/pack	1/8"	4-1/2"	.020"	180

Flexible Abrasives

Used for hundreds of jobs - including metal cleaning, commutator burnishing and rust removal.

S.E.E.S. #	Description	L	W	H
MRR-001	Rubrite, unmounted	5"	3/8"	3/8"
MRR-002	Rubrite, unmounted	5"	5/8"	3/8"
MRR-003	Rubrite, unmounted	5"	1/2"	1/2"
MRR-004	Rubrite, unmounted	5"	1/2"	1"
MRR-005	Rubrite, unmounted	5"	1"	5/8"
MRR-006	Rubrite, unmounted	5"	3/4"	3/4"
MRR-008	Rubrite, unmounted	5"	2"	1"
MRR-009	Rubrite, unmounted	5"	3"	1"
MRR-010	Rubrite, unmounted	5"	1"	1/8"

Tools

Diamond Spatulas

S.E.E.S. #	Description
MDS-001	Diamond Spatula, Green, coarse grit
MDS-002	Diamond Spatula, Red, medium grit
MDS-003	Diamond Spatula, Blue, fine grit
MDS-KIT	Diamond Spatula, Kit, 1 of each (Green, Red, Blue)
MDS-KIT-001	Diamond Spatula, Kit 1 of each (Yellow, Red, Blue)



MDS-KIT



MDS-KIT-001

Identification Stencils

S.E.E.S. #	Description
Q-CARDS	Cards Elevator Set, Magnetic Stencils for Hoistway and Equipment Identification



Q-CARDS

Tools

S.E.E.S. #	Description
MBTS-001	Brush Tension Scale, 15 pounds
MIS-TOOL-008	Snap Ring Pliers Set, Internal & External
MU-001	Undercutter, Mica-Miller, 115V with standard head
WR-QBTM-2	Quick-Balance Tension Meter



MBTS-001



MU-001

Tool Box

S.E.E.S. #	Description
MIS-TOOL-BOX	Portable Tool Chest, Red, 20-1/2" Width x 9-5/8" Height x 8-5/8" Deep, 3 Storage drawers



SEES-TOOL-BOX



SEES-TOOL-TOTE

SEES Tool Bag

S.E.E.S. #	Description
SEES-TOOL-TOTE	Tool Tote, with Soft Sides Heavy Duty, 12.5" L x 7.5" W x 5.5"

Trash Bags, Brooms and Absorbent

S.E.E.S. #	Description
MIS-TRASH-BAGS	30 gal. Black Trash Bags, Heavy Duty Coreless Roll of 70
MIS-PUSH-BROOM	Push Broom, 24" Sweep Face
MIS-DUST-PAN	Dust Pan, Metal, 17"
MIS-ANGLE-BROOM	Angle Broom, 13" Sweep Face
MIS-ABSORBENT-001	Absorbent, Loose, 40 lb. Bag
MIS-WET-DRY-VAC	Wet Dry Vac, 5 Gallon Bucket Head



MIS-WET-DRY-VAC



ALPHA TAGS



Application

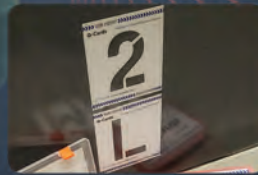
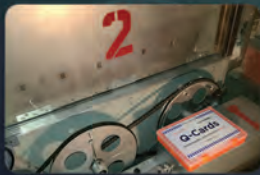

MAGNETIC ALPHA-NUMERIC STENCILS

CREATE A CLEAN, BEAUTIFUL LANDING MARKING FOR THAT FINISHING TOUCH ON A WELL BUILT ELEVATOR

DON'T DO ANOTHER JOB WITHOUT ALPHA TAGS



Convenient & Simple

Easily slap on the magnet and with spray paint or a large felt pen, safely mark your landings or equipment.



Easily transported

Stencils come in a compact hard-shell carrying case for safekeeping.



Better than Paper

No more fumbling around with paper stencils as tape, these stencils allow for a faster hoistway marking experience and professional looking finish.



Kerning Gauge

A kerning gauge is included for uniform gaps between characters.

SEES Part#: Q-CARDS

**CODE
COMPLIANT**

**4.5" TEXT SIZE
MEETS 2.9 ID
REQUIREMENTS**

Always Smooth Sailing



SOUTHERN ELEVATOR
& ELECTRIC SUPPLY



SEES Inc



SEESParts

2781 West McNab Rd, Pompano Beach, FL 33069 • (800) 526-0026 • www.SEESinc.com

Tools

Screwdrivers and Fasteners

S.E.E.S. #	Description
MIS-126A	Screwdriver, Screwdriver with Ratchet and 12 Bits, Phillips #0, #1, #2, Slotted #4, Spanner #6 x #8, #10 x #12, Torx(R) T10 x T15, T20 x T25
MIS-126B	#6 Spanner Bit
MIS-126C	#8 Spanner Bit
MIS-126D	#10 Spanner Bit
MIS-126E	Phillips Bit
MIS-126F	Torx Bit, star point
MIS-126G	Screwdriver, 16-in-1, without Ratchet A590A
MIS-126H	Screwdriver, 15-in-1, Elevator Service and Repair
MIS-128	Tamper Proof Screw, 10/32 x 1", Nickel plated
MIS-129	Tamper Proof Screw, 10/32 x 2", Oval Head, stainless steel
MIS-131	Tamper Proof Screw, 8/32 x 1", Nickel plated
MIS-133	Tamper Proof Screw, 6/32 x 1", Nickel plated
MIS-128A	Tinnerman Clip for 10-32 thread
MIS-130MR	Tamper Proof Screw, M4x25mm, Round Hex Pack of 100
MIS-131A	Tinnerman Clip for 8-32 thread
MIS-132	Screw, Tamper Proof, 8-32 x 1-1/2
MIS-133A	Tinnerman Clip for 6-32 thread
MIS-134	Tinnerman Clip for 1/4 x 20 thread
MIS-134A	Cage Nut, .093 thru 126 thk used in Adams & Epco fixtures for 10-32 thread
MIS-159	Security Seal, lead seal with 10" monel wire to secure governor speed settings as required by inspectors for code compliance.
OB-100	Tool, manual driver for security fasteners used on Otis LRV car panels
OB-100A	Security Screw, LRV Car Panel screw used with OB-100
OB-101	Tool, Hall panel driver #6 A
MIS-130M	Screw, Tamperproof M4x25mm, Pan, Pack of 100, M4.7

*photos enlarged to show detail



Solder Pot & Babbit

S.E.E.S. #	Description
MIS-TOOL-100	Solder Pot, 20lbs, 115 VAC 5" I.D. x 9" D, Adj temp 200-800F
MIS-TOOL-101	Ladle, 2.5" Bowl x 9.5" Long for solder pot
MIS-TOOL-103	Babbit, Lead Free pucks (Rohos)



MIS-TOOL-101



MIS-TOOL-103



MIS-159

MIS-100A

Lubricants

S.E.E.S. #	Description
MIS-100A	Cable Lubricant, 1 gallon. Keeps cables running smoother, more efficiently
MIS-100B	Bearing Oil, 1 gallon. Lubricates sleeve type bearings on motor generators
MIS-100C	Detector Face Plate Cleanser, 1/2 quart. Non-residual anti-static cleanser
MIS-100D	Hydraulic Oil, 1 gallon. Specially formulated for all types of hydraulic elevator pistons
MIS-100D5	Hydraulic Oil, AW32 5 gallon pail
MIS-100D55	Hydraulic Oil, AW32 55 gallon drum
MIS-100D55-BIO	Hydraulic Oil, Bio, 55 gallon drum
MIS-100P	Grease, Gear & Chain "Sling Free", 10.5oz tube



MIS-TOOL-100



MIS-100D55



MIS-100D5



MIS-100P

Cleaners, Lubricants and Sealants



MIS-100K



MIS-100E5



MIS-100M



MIS-100Q



MIS-100S



MIS-CLEAN-WIPES



MIS-CLEAN-WIPES-001



MIS-171-KIT



MIS-100



MIS-101B



MIS-104A

Lubricants

S.E.E.S. #	Description
MIS-100E	Worm Gear Oil , 1 gallon. Lubricates worm gears
MIS-100E5	Worm Gear Oil , #7, 5 Gal Pail, 71011EP, 140Wt
MIS-100F	Way Oil , for Drive Chain, 1 gallon. Excellent grade to lubricate chain bushings and pins
MIS-100G	Grease , Multi-Purpose, 14 oz. General purpose lubricant
MIS-100H	Buffer Oil #6 , 1 gallon. Anti-wear hydraulic oil formulated for door checks and oil buffers
MIS-100K	Stepper Lube Kit , assorted lubricants, specially formulated for maintaining stepping switch wear points. Prolongs life, improves performance
MIS-100L	Rail Lube , 1 gallon. Paraffin based lubricant designed for automatic rail lubricators
MIS-100M	Lubriplate , general purpose lock and linkage grease, 3/8 oz. tube
MIS-100Q	Rail Lube , 1 quart
MIS-100R	Cable Lube , 1 quart
MIS-100S	Slipit Silicone-Free Liqui-Form (Case, 15 Quart Bottles)
MIS-SPOUT-OILER	Precision Spout Oiler , with All-Purpose Oil

Cleaners

S.E.E.S. #	Description
MIS-SIMPLE-GREEN	Simple Green , All-Purpose Industrial Cleaner / Degreaser, 1 Gallon
MIS-CLEAN-WIPES	Heavy Duty Cleaning Wipes
MIS-CLEAN-WIPES-001	Heavy Duty Cleaning Wipes for Stainless Steel

O-Ring Kit

S.E.E.S. #	Description
MIS-171-KIT	O-Ring Assortment Kit , Buna Size 006 Thru 334

Rope Oilers

Automatic Rope Oiler keeps ropes lubricated to increase the lifetime of rope up to 400%, and prevent rope grooves from wearing in the sheave.

S.E.E.S. #	Description
MIS-100	Rope Oiler with 9" wick
MIS-102	Rope Oiler with 12" Wick
MIS-100A	Cable Lubricant , used with MIS-100 & MIS-102
MIS-103	Extension Bracket for rope oiler
MIS-103A	Replacement Wick for all size oilers
MIS-103B	Replacement Wick , 1/2" x 6-1/2" x 12"
MIS-104	Wire Rope Cleaning Kit
MIS-104A	Replacement Brush , For MIS-104 Wire Rope Cleaning Assy
MIS-104B	Wire Rope Cleaning Solution , For MIS-104, 1 Gallon

Rail Lubricator

S.E.E.S. #	Description
MIS-101B	Rail Lubricator for 8 & 15 lb. Rails
MIS-101C	Oiler Wick , braided cotton, 1" x 7.5"
MIS-100L	Rail Lube , 1 gallon. Paraffin based lubricant designed for automatic rail lubricators, for use with MIS-101B Rail Lubricator

Cleaners, Lubricants and Sealants

X-Pando

The problem solver for over 60 years!

Special expanding cements for use with pipe couplings, ceramic and glass

- X-Pando Pipe Joint Compound - for threaded or flanged joints made of iron, steel, brass, copper, stainless steel or PVC.
- X-Pando Special No. 2 - pipe joint compound for cement lined pipes to be welded.

S.E.E.S. #	Description
MIS-XPANDO-001	Pipe Joint, Compound 14oz Can
MIS-XPANDO-002	Pipe Joint, Compound 70oz Can
MIS-XPANDO-003	Pipe Joint, Compound 25 lb drum
MIS-XPANDO-004	Pipe Joint, Compound 50 lb drum
MIS-XPANDO-005	Pipe Joint, Compound 100 lb drum
MIS-XPANDO-006	Pipe Joint, Compound Spec #2 14oz Can
MIS-XPANDO-007	Pipe Joint, Compound Spec #2 70oz Can



MIS-XPANDO-001



MIS-XPANDO-003

Polycel 100

This remarkable urethane sealant foam expands when activated by moisture in the air. The unique chemical properties dry in less than one hour, eliminates chain, counterweight, and pipe rattle problems. Muffles noise and seals and fills gaps wherever needed.

S.E.E.S. #	O.E.M. #	Description
MIS-215		Polycel 100, 12 oz. can, urethane sealant

S.E.E.S. #	O.E.M. #	Description
MIS-CHEM-002	53300LO	Thermal Compound, 3CC syringe



MIS-215



MIS-CHEM-002

CRC® Chemicals Products

S.E.E.S. #	Description
CRC-6	Lectra-Clean® 20 oz. spray can, specially formulated solvent for the cleaning & degreasing of dirty, corroded electrical equipment. It quickly removes grease, oil, wax, dirt, moisture and other foreign substances. Non-Conducting, non-corrosive, evaporates fast, leaves no residue. Ideal for heavy duty cleaning/degreasing applications.
CRC-6A	Lectra-Clean® 5 gallon pail, the same famous formula in an economical industrial size.
CRC-11	Cable-Clean® 20 oz. spray can, formulated to effectively remove contamination from semi-conducting jackets and insulations of high voltage cables before splicing and terminations. It may be used on a variety of elastometric and thermo plastic insulations and jackets. No flash or fire point, non-conductive, and non-corrosive to metals.
CRC-16	Hydro Force Cleaner Degreaser® 18 oz. spray can, quickly penetrates and removes grease and grime from washable surfaces. Safe for use on most metals, plastics, rubber compounds and fabrics. Perfect for use in the machine room, pit or for clean-ups anywhere. Keep plenty on hand.



CRC-6



CRC-11



CRC-16

Scientifically formulated to protect, preserve and improve performance of valuable equipment. Environmentally safe, no CFC's.



SEES Solutions

Formulated exclusively for the elevator professional.



S.E.E.S. #	O.E.M. #	Product Description
SSEE-001	APA100CC	Water & Temperature Resistant Grease. Heat Stable. Deep Penetrating. NET WT. 11 OZ. (311 Grams)
SSEE-002	APA140CC	Dry Silicone Spray. Fast, Safe on Plastic. Reduces Friction. Non-Staining. NET WT. 11 OZ. (311 Grams)
SSEE-003	APA130CC	Electronic Contact Cleaner, Non-Flammable, Dries Fast. Zero Residue. Non-Corrosive. 30,000 Volt Dielectric Strength. Safe on most plastics. NET WT. 10 OZ. (283 Grams)
SSEE-004		High Purity Contact Cleaner, Quick Drying Formula. Electrical grade. Leaves no residue. Plastic Safe. NET WT. 11 OZ. (311 Grams)
SSEE-005	APA180CC	Chain & Cable Lubricant. Prevents Corrosion. High Pressure & Extreme Temperature Resistance. NET WT. 15 OZ. (425 Grams)
SSEE-006	APA31GC	Metal Parts Protector (Guide Rail Protector) Long Term. Flexible Dust Retardant Coating. Easily Applied & Removed. NET WT. 14 OZ. (396 Grams)
SSEE-007	APA150CC	Heavy Duty Penetrating Oil. Super Penetrating Nut Loosener with Capillary Wet Drilling Action. Stops Squeaks Fast. Frees Rusted & Corroded Parts. NET WT. 15 OZ. (425 Grams)
SSEE-008	APA160CC	All Purpose Mechanics Spray. Non-Flammable. Penetrates, Lubricates, Cleans, Never Dries, Displaces Water 39,000 Volt Dielectric Strength. NET WT. 12 OZ. (340 Grams)
SSEE-009		Metal Cleaner & Polisher. Effective on all Metal Surfaces. Cleans, Polishes, Beautifies. Non-flammable, Odorless. NET WT. 18 OZ. (1 LB. 2 OZ.) (510 Grams)
SSEE-011		High Tack Belt Dressing. Stops Slippage. Increases Equipment Efficiency. Sprays when Held Upright or Inverted. NET WT. 12 OZ. (340 Grams)
SSEE-012		Air Duster, 8 oz
SSEE-013		Germicidal Cleaner, Case of 12, 20oz
SSEE-013-STORE		Germicidal Cleaner, Sold as Each
SSEE-014		Disinfectant Spray Q, Country Fresh Case of 12, 20oz
SSEE-014-STORE		Disinfectant Spray Q, Sold as Each, 20oz

Packaged 6 per carton unless otherwise specified

The SEES Library *Technical reference to aid the elevator professional*

Elevator Books

S.E.E.S. #	Description
BOOK-001A	2020 Field Safety Handbook , up to date resources for safety information that the elevator industry field employees shall use to help prevent injuries and illnesses resulting from unsafe acts and/or conditions.
BOOK-002	Elevator Maintenance Manual , An in-depth guide, designed for the service technician, covering elevator maintenance programs and practices as related to electric and hydraulic elevators. Also covers, escalators and moving walks.
BOOK-003	Elevator Field Maintenance Handbook , Pocket sized companion designed for the service mechanic to take into the field. Contains over 75 charts and guides.
BOOK-004	Facility Manager's Operation and Maintenance Handbook , will help give the facility manager guidance in maintaining continuity in all services, running a professionally managed property and achieving each of these.
BOOK-005	Elevator & Escalator Maintenance for Building Managers , 2nd Edition In-depth guide designed for the service technician, covering elevator maintenance programs and practices as related to both electric and hydraulic elevators. Also covers escalators and moving walks. Can be used for "how-to" guide that can be used for training classes, home study or as a reference guide.
BOOK-007	Field Employees' Elevator Testing Manual , for various tests on electric and hydraulic passenger and freight elevators in the presence of a Certified Elevator Inspector. Can help with understanding of what is being tested, why it is being tested and a safe means to demonstrate the function
BOOK-008	Electrical Engineering Handbook , contains tables, charts and motor data carefully selected for everyday use.
BOOK-009	2009 International Building Code , comprehensive building code establishes minimum regulations for building systems using prescriptive and performance-related provisions. This edition is fully compatible with all International Codes (I Codes) published by the International Code Council
BOOK-010	Electric Elevator & Escalator Maintenance Logbook , designed to comply with ASME A17.1 Safety Code
BOOK-011	Hydraulic Elevator & Escalator Maintenance Logbook , designed to comply with ASME A17.1 Safety Code
BOOK-012	FEM Terminology , provides exact names for each part of the elevator (lift) in eight languages. English, German, French, Spanish, Italian, Dutch, Danish and Portuguese.
BOOK-014	Maintenance on New Equipment Designs , Is maintenance different on new equipment? What documentation is required by code? What is a maintenance control program? Find the answers to these questions and more in this valuable reference.
BOOK-016	Safety Meetings, 7th Edition
BOOK-017	Elevator Industry Inspection Handbook - 7th Edition
BOOK-018	Safety Meetings - 8th Edition



BOOK-001A



BOOK-002



BOOK-003



BOOK-004



BOOK-005



BOOK-007



BOOK-008



BOOK-009



BOOK-010

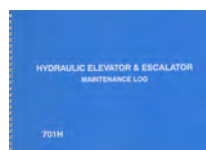

BOOK-011



BOOK-012



BOOK-014



BOOK-016



BARRICADE SALE!



- ✓ LIGHT AND PORTABLE
- ✓ PREVENTS ACCIDENTS
- ✓ EASY TO USE AND CLEAN
- ✓ RUGGED CONSTRUCTION

 **CALL NOW: 800.526.0026**

UNBEATABLE SAVINGS!

BARR-001A

36" W X 42" H panel, 10mm thick

LIST: ~~\$28~~
SALE PRICE: \$22



BARR-003

(3) 36" W x 42" H panels, 10mm thick, with anchors and (2) locks

LIST: ~~\$140~~
SALE PRICE: \$110



BARR-004

(4) 36" W x 42" H panels, 10mm thick, with anchors and (3) locks

LIST: ~~\$175~~
SALE PRICE: \$140



WHEELS/ROLLERS & GUIDES

QUICK LOCATOR GUIDE

Roller Guide Assemblies

10" OD	492
7-7/8" OD	492
6-1/2" OD	492
6" OD	492
5-3/4" OD	492
4.92" OD	493
4-1/2" OD	493
3-3/4" OD	493
3-1/4" OD	493
3.156" OD	493
3" OD	493
2.98" (76MM) OD	493
Cover Plates	494

Guide Rollers

10-1/4" OD	495
10" OD	495
8" OD	495
7-7/8" OD	495
7-3/4" OD	495
7" OD	495-496
6-1/2" OD	496
6-5/16" OD	496
6" OD	496-497
5.91" OD	497
5.875" OD	497
5-3/4" OD	497
5" OD	497
4.92" OD	497
4-7/8" OD	497-498
4-1/2" OD	498
4.48" OD	498
4-3/8" OD	498
4" OD	498
3.94" OD	498

3-15/16" OD	498
3.82" OD	498
3-3/4" OD	498
3-1/2" OD	498-499
3-3/8" OD	499
3-1/4" OD	499
3.16" OD	499
2.36" OD	499
3.15" OD	499-500
3-1/8" OD	500
3.132" OD	500
3" OD	500
2-7/8" OD	500
2-3/4" OD	500
2-5/8" OD	500
2-9/16" OD	500
2-1/2" OD	500

Hanger Assemblies

4-3/8" OD	502
4-14" OD	502
3-3/8" OD	502
3-1/4" OD	502
3-5/16" OD	502
2-7/8" OD	502
2-3/4" OD	502
2-1/4" OD	503

Hanger Rollers

5.12" OD	505
4-3/8" OD	505
4-1/4" OD	505
3.812" OD	505
3.7" OD	505
3-11/16" OD	505
3.54" OD	505

3.39" OD	505
3-3/8" OD	505-506
3-5/16" OD	506
3-1/4" OD	506-507
3.25" OD	507
3.135" OD	508
3" OD	508
2.95" OD	508
2.91" OD	508
2-7/8" OD	508
2.83" OD	508
2.76" OD	508
2-3/4" OD	508
2.68" OD	508
2-5/8" OD	508
2.56" OD	508
2-1/2" OD	509
2.44" OD	509
2.35" OD	509
2-1/4" OD	509
2.2" OD	509
2.19" OD	509
2.13" OD	509
2" OD	509
1.98" OD	509
1.89" OD	509
1.8" OD	509
1.73" OD	509
1.69" OD	509
1.42" OD	509

Bearings

Bearings	510
----------	-----

Slide Guides

Slide Guides	510
--------------	-----

Miscellaneous Rollers

Misc. Rollers	501
---------------	-----



Roller Guides

Roller Guide Assemblies

S.E.E.S. #	O.E.M. #	Description
KOGS-9A	KM600655G03	Roller Guide Assembly , 5.91" x 1.5" (150mm x 38mm x 2mm) 6003 ID:17mm
MW-11A	P28305	Roller Guide Assembly , 10" wheels with poly tire, 3-wheel
MW-11AK	P28305	Roller Guide Assembly , 10" 3 wheel replacement to P28305, includes URG-004 and MW-11B
MW-11B		Adapter Plate , for URG-004
OW-10D	B261AM3	Roller Guide Assembly , 10" O.D. for #1 Rail, Top
OW-10E	B261AM4	Roller Guide Assembly , 10" O.D. for #1 Rail, Bottom
OW-10F	B261AM5	Roller Guide Assembly , 10" O.D. for #1/2 Rail, Top
OW-10G	B261AM6	Roller Guide Assembly , 10" O.D. for #1/2 Rail, Bottom
OW-10H	B261AM1	Roller Guide Assembly , 10" O.D. for #3/4 Rail, Top
OW-10K	B261AM7	Roller Guide Assembly , 10" O.D. for #0A Rail, Top
OW-10L	B261AM8	Roller Guide Assembly , 10" O.D. for #0A Rail, Bottom
OW-7E	6261C1	Roller Guide assembly , 7-7/8" O.D. for #1 & #1-1/2 Rail, Top
OW-7F	6261C4	Roller Guide assembly , 7-7/8" O.D. for #1 & #1-1/2 Rail, Bottom
OW-7K	F6261C2	Roller Guide Assembly , 7-7/8" O.D. for #3/4 Rail, Top
OW-7L	F6261C5	Roller Guide Assembly , 7-7/8" O.D. for #3/4 Rail, Bottom
OW-7M	F6261C3	Roller Guide Assy , counterweight, 7-7/8" O.D. for #1 and #1-1/2 Rail, Top
MW-6AK	P25220	Roller Guide assembly , 6-1/2" 3-wheel
WRG-001	627D989G08	Roller Guide assembly , 6", 5-18 lb rail
WRG-004	627D989G05	Roller Guide assembly , 6" CVT Rail 5219D47G0
HWRG-002	378	Roller Guide assembly , 6" diameter 3-Wheel
URG-002	P25220	Roller Guide assembly , 6" universal 3-wheel, Type B
URG-004		Roller Guide assembly , 10" universal 3-wheel
URG-006		Roller Guide assembly , 6-wheel 3-1/4" trolley roller guide Type C
URG-007	33SRG	Roller Guide assembly , 3-1/4", 3-Wheel, Adjustable Spring Roller guide, sold individually
URG-002H		Roller Guide Assy , 3 Wheel, 6" O.D. Model B, with 90Duro Wheel
URG-002N	Model B	Roller Guide assembly , 3 Wheel, 6" O.D. Model B, with Neoprene Rollers
URG-005-SRB		Rebuild Kit , for URG-005 Adjusting Hub & Spring
URG-R3		Roller Guide assembly , 5.92" O.D and 3.87" O.D.
URG-R6		Roller Guide assembly , 5.88" O.D.
URG-009	36SRG	Roller Guide assembly , 5-3/4", 3-Wheel, Adjustable Spring Roller guide, sold individual
URG-010	815RG	Roller Guide assembly , 5-3/4", 3-Wheel, Adjustable Roller guide, sold individually



URG-004



MW-11A



MW-11B



WRG-001



WRG-004

HWRG-002



URG-002



URG-009



URG-007



URG-010



■ Cover Plates available. See page 494.

Features

- **Long Lasting** Polyurethane Rollers
- **Strong** cast iron base and roller arms
- Adjustable tensioning springs for light load or heavy load applications
- Offering a superior **SMOOTH** ride for passengers

Roller Guide Assemblies

S.E.E.S. #	O.E.M. #	Description
OW-30A	KAA25830A1	Roller Guide assembly, 4.92" O.D., Top for 2 & 1-1/2# Rail, Each, 3-Wheel
OW-30B	KAA25830A2	Roller Guide assembly, 4.92" O.D., Bottom for 2 & 1-1/2# Rail, Each, 3-Wheel
OW-30C	KAA25830A3	Roller Guide assembly, 4.92" O.D., Set of 4 for 2 & 1-1/2# Rail
WRG-003	627D989G03	Roller Guide assembly, 4.5" & 6" roller 8-16# CWT Rail, 3-Wheel
WRG-007	627D989G04	Roller Guide assembly, 4.5" & 6" roller 18.5# CWT Rail, 3-Wheel
OW-9A	6261P1	Roller Guide assembly, 3-3/4" O.D., with three OW-9 rollers
MIS-188J		Roller Guide assembly, 3-3/4" O.D. x 5/8" Face 1-1/4" W, (2) 99502H (5/8" Bore)
URG-001		Roller Guide assembly, 3-1/4" universal 3-wheel, Type D
URG-001N	Model D	Roller Guide assembly, 3 W, 3-1/4" O.D. Type D, Neoprene Rollers
URG-008	803RG	Roller Guide assembly, 3-1/4", 3-Wheel, Adjustable Roller guide, sold individually
HWRG-001	377	Roller Guide assembly, 3-1/4" diameter 3-Wheel
KOGS-7A		Roller Guide assembly, 3.156" O.D. / .625" 80mm O.D./ 16mm rail, Spring 3 wheel
KOGS-7		Roller Guide assembly, 3.15" O.D., .39" rail, 3-wheel, adjustable spring
WRG-002	465D274G01	Roller Guide assembly, 3", 3-wheel, adjustable spring, 8-16# CWT rail
WRG-005	465D274G02	Roller Guide Assembly, 3" roller 8-16# Car Rail, 3-Wheel
WRG-006	465D274G03	Roller Guide assembly, 3" roller, R9264601 Replacement, 3-Wheel
OW-9AC	KAA25830B1	Roller Guide assembly, 3" O.D., Top for 2# Rail, Each, 3-Wheel
OW-9AD	KAA25830B2	Roller Guide assembly, 3" O.D., Bottom for 2# Rail, Each, 3-Wheel
OW-9AE	KAA25830B3	Roller Guide assembly, 3" O.D., Top for 1-1/2# Rail, Each, 3-Wheel
OW-9AF	KAA25830B4	Roller Guide assembly, 3" O.D., Bottom for 1-1/2# Rail, Each, 3-Wheel
OW-9AI	AAA456YS2	Roller Guide assembly, 3" (76mm) O.D., for Roller Guide
OW-9AB	6261P1, KAA25830B5	Roller Guide assembly, New Style 2.98" (76mm) Wheel, KAA25830B5 set of 4, hardware included
OW-210	6161AA1	Roller Guide assembly, 3" Round Rail
OW-210A	384LN2	Roller Guide assembly, Guard for 616AA



WRG-003



WRG-007



OW-9A



URG-001



URG-006



URG-008



HWRG-001



WRG-002



WRG-005



WRG-006



OW-9AB



KOGS-7



SEES UNIVERSAL ROLLER GUIDE

Roller Guides

S.E.E.S. #	O.E.M. #	Description
URG-001	ED02000	3-1/4" Universal 3 wheel roller guide Model D
URG-002	EB02100	6" Universal 3 wheel roller guide Model B
URG-006	EC18400	3-1/4" Universal 6 wheel roller guide Model C

Replacement Rollers

S.E.E.S. #	O.E.M. #	Description
MIS-143S	EC18405	3-1/4" diameter, .4724 bore wheel
MIS-142	EA18359	6" diameter, .7874 bore wheel

Cover Plates

S.E.E.S. #	O.E.M. #	Description
URG-001C	ED02013	Cover Plate Model D
URG-002C	EB02123	Cover Plate Model B
URG-005C	EA18333	Cover Plate Model A
URG-006C	EC18403	Cover Plate Model C
URG-001-HDW		Bolts, for Rollers, Set of 3 for URG-001



URG-001C



URG-002C

*For More Guide Roller Options, & Other Wheel and Roller Types
See Individual Catalog Sections*

Roller Guides

Guide Rollers

S.E.E.S. #	O.E.M. #	Description
WW-23	M5594G03	Roller Guide wheel , 10-1/4" dia., .6693" I.D.
URGW-004		Roller Guide wheel for URG-004, 10", bearing 6004 I.D.: .77"
NW-003	112-8001	Roller Guide wheel , Northern 10" Guide Roller, .25" Face, .9843" I.D.
MW-11	P7087	Roller Guide wheel , 10" O.D., wheel with polyurethane tire, .9843" bearing I.D. for P28305 assembly
OW-10	456CV4	Roller Guide wheel , 10" O.D. x 1-1/2" Polyurethane tire, shaft with maintenance free sealed bearing
OW-10C	456ACH1	Roller Guide Wheel , 10" O.D. x 1.5" W x .20 Face, with Shaft
HW-12	35-1159-002	Roller Guide wheel , 8" O.D. x 1-3/8" W, 1/2" W tire face, .630" bearing I.D., bushing with 5/8" dia., Hardware part # HW-12C
HW-12A	3-40329-10	Roller Guide wheel , 8" x 1-1/4", 7/8" I.D.
HW-12AH	3-40329-1	Roller Guide wheel , 8" O.D. x 3/4" Face x .787" I.D., HD 90 Duro
HW-12B	3-40119-75	Roller Guide , 10" O.D. x 1-5/16" W 3/4" Tire, Z995204 Brng
HW-12C	3-40119-75	Roller Guide , 10" O.D. x 1-5/16" W 3/4" Tire, Z995204 Brng
MIS-238	35-1159-002	Roller Guide wheel , 8" x 1-3/8", same as HW-12 but HD 95 Duro
DW-14	9831824, 63182	Roller Guide wheel , 8" O.D., .7874" I.D., two bearings
DW-14H	9831824	Roller Guide wheel , 8" O.D. x .7874" I.D., HD 90 Duro
OW-7	456CL4	Roller Guide wheel , 7-7/8" O.D. x 1-1/2" Polyurethane tire with sealed maintenance free bearing, hub extends past tire width on shaft side, after Dec. '62
OW-7H	456CL4	Roller Guide wheel , 7-7/8" O.D. x 1-1/2" W with shaft, HD 90 Duro
OW-15	456AJ2	Roller Guide wheel , 7-7/8" O.D. x 1-1/2" Polyurethane tire with sealed maintenance free bearing with shaft, hub extends past tire width on side opposite shaft, 1941 thru 1962
OW-15H	456AJ2	Roller Guide wheel , 7-7/8" O.D. x 1-1/2" W with shaft, HD 90 Duro
AW-14	168962G01, 515606	Roller Guide wheel , 7-7/8" O.D. Tire face .375" wide, Hub 1-1/2" wide, Double bearing with shaft, 2-3/4" overall length
ACLAW-003		Roller Guide wheel , 7-7/8" x 1 3/8" 200mm x 35mm w/ 6306 bearing (30mm I.D.)
MW-10	P12592	Roller guide wheel , 7-3/4" O.D., .9843" bearing I.D.
MW-10H	P12592 90 duro	Roller guide wheel , 7-3/4" O.D., 90 Duro
MIS-187B-STEEL		Roller guide wheel , 7" Steel Hub, Rubber Lining, Payne



WW-23



NW-003



MW-11



OW-10



HW-12



HW-12A



DW-14



OW-7



OW-7H



OW-15



AW-14

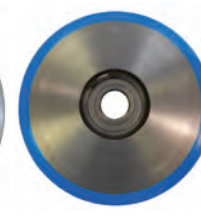

ACLAW-003



MW-10



Guide Rollers

S.E.E.S. #	O.E.M. #	Description
MIS-187B	M1292	Roller Guide wheel , 7" O.D. x .7874" bearing I.D. x 1-1/4" W tire. Double bearing. Tire face 1/2
NW-002	112-2040	Roller Guide wheel , Northern 7" Guide Roller, .25" Face, .6693" I.D.
AW-9	11939-01, B653002	Roller Guide wheel , 7" O.D. with threaded eccentric shaft. Threaded shaft 5/8-11 jam nut, 3-1/2" overall length. Tire face 1/2" wide, hub width 1-1/8"
AW-9A	11940-01, B653003	Roller guide wheel , 7" O.D., double bearing, .6693 I.D. Tire face is 1/2" wide, hub width is 1-1/8" wide. Similar to AW-9 but without eccentric.
AW-9AH	11940-01	Roller Guide wheel , 7" O.D. x 6693" I.D. without Eccentric, HD 90 Duro
AW-9H	11939-01	Roller Guide wheel , 7" O.D. x 6693" I.D. with Eccentric, ARW423 HD 90 Duro
STW-002	2004A-D6B	Roller Guide wheel , 6-1/2" O.D. .9843" I.D. (Double 6205 Brg)
MW-5	P3174	Roller Guide wheel , 6-1/2" O.D., .9843" bearing I.D., 1-1/4" tire width
MW-6	P2789	Roller Guide wheel , 6-1/2" O.D., .9843" bearing I.D., 1-1/4" tire width tapered to 1/2" wide tire face
OW-29		Roller Guide wheel , Guide Roller 6-5/16" O.D. 1-1/4" W x .9843" I.D. (2x6205)
OTGS-15		Roller Guide wheel , for Guide Shoe 6.3" x 1.88" (160mm x 30mm), bearing 6203 ID:17
THGS-3		Roller Guide wheel , For Roller Guide Assy 6.03" x 1.27" (153mm x 32mm x2 mm) 6204 Brg
HWW-002	378-14	Roller Guide wheel , Hollister Whitney, 6" diameter face roller, .430" face
HWW-002A	378-15	Roller Guide wheel , Hollister Whitney, 6" diameter side roller, .865" face
WW-21	323C160G01 323C160G02	Roller Guide wheel , 6" diameter, tire face 13/16", .6693", I.D., double bearing
MIS-142	18359	Roller Guide wheel , 6" O.D. x .7874" bearing I.D. x 1-1/4" W poly tire w/ 1/2" face. Double bearing, replacement wheel for URG-005
MIS-142A	18347	Roller Guide wheel , 6" x 1-1/4" W with 7/8" Face
MIS-142H	18359-H	Roller Guide wheel , 6" O.D. x 1-1/4" W x 1/2" F, .7874 I.D., HD 90 DURO
MIS-142AH	18347-H	Roller Guide wheel , 6" O.D. x 1-1/4" W x 7/8" F, .7874 I.D., HD 90 DURO



MIS-187B



NW-002



AW-9



AW-9A



AW-9AH



AW-9H



STW-002



MW-6



OTGS-15



HWW-002



MIS-142A



MIS-142H



MIS-142AH



WW-21



MIS-142

Guide Rollers

S.E.E.S. #	O.E.M. #	Description
MIS-142N	18359	Roller Guide wheel , 6" O.D. x .7874" bearing I.D. x 1-1/4" W, neoprene tire with 1/2" face. Double bearing, replacement wheel for URG-005
GW-2	378-12	Roller Guide wheel , 6" O.D. with 1/2" face, 2 bearings, .6693" I.D.
GW-2A	378-13	Roller Guide wheel , 6" O.D. with 3/4" face, 2 bearings, .6693" I.D.
ACLAW-002	M1503	Roller Guide wheel , 6" x 1-3/8", 150mm x 35mm with 6306 bearing (30mm I.D.)
CEMW-002A		Roller Guide wheel , 6" x 1-3/8", 150mm x 35mm, 30mm I.D., with Shaft
TW-003		Thyssen Tach Roller , 6" O.D. x 1.25" W 5/8" Face, Roller Only, No bearing
TW-003A		Thyssen Tach Roller , 6" O.D. x 1.25" W 5/8" Face, with Hub-Shaft and Bearings
KOGS-9		Roller Guide wheel , for Guide Shoe 5.91" x 1.5" (150mm x 38mm x 2mm), bearing 6003 ID:17mm
SCGS-15		Roller Guide wheel , for Guide Shoe 5.91" x 1.88" (150mm x 30mm x 2mm), bearing 6201 ID:12
CEMW-002		Roller , 150mm x 35mm, 6306 Brg 30mm I.D., 5-29/32" O.D.
MIS-188C		Roller Guide wheel , 5.875" O.D. x 1.578" W with 6204 brg (.7874" I.D.)
TW-004		Thyssen Roller Guide Wheel , 5-7/8" O.D. x 1" W .984" I.D. 6205 Brg, 3/8" Face
ELCW-001	76-15-001	Roller Guide wheel , DELCO 3" O.D. x 1" W 6203 Bearing, .660" Face
ELCW-001A		Shaft Assembly , for ELCW-001, Bolt, Eccentric Nut, Spacer and Nut
ELCW-002	124.5-15-001	Roller Guide wheel , DELCO 124.5mm (4.90") O.D. x 7.8" W 6203 Bearing, .560" Face
ELPW-001	815RGW	Roller Guide wheel , 5-3/4" O.D. x 5/8" I.D. for URG-009 and URG-010, Offset Bearings
ELPW-002	36SRGW	Roller Guide wheel , 5-3/4" O.D. x 5/8" I.D., for URG-009, Elpro, Centered Bearings
MIS-187A		Roller Guide wheel , 5" O.D. x .7874 bearing I.D. x 1-1/4" W tire. Double Bearing. Tire face 1/2"
MIS-188D	300BS50093/	Roller Guide wheel , 5" O.D. x 1.57" W with BR2-25 (2) 6204 brg (.7874" I.D.), Bucher
HW-5	35-1159-004	Roller Guide wheel , 5" O.D. x 1-1/8" W, 7/16" W tire face, bearing has steel inner sleeve with .630" bearing I.D.
DW-18		Roller Guide wheel , 5" O.D., .985" I.D., replaces Watson roller
KOGS-8		Roller Guide wheel , for Guide Shoe 4.92" x 1.03" (125mm x 26mm x 2mm), bearing 6003
MIS-188A		Roller Guide wheel , ACLA, 4.92" O.D. x 1.185" W 6204 bearing
HLW-007		Roller , for WC Cantalever Roller 4-7/8" O.D. x 1.375" with Ecc Shaft



MIS-142N



GW-2



GW-2A

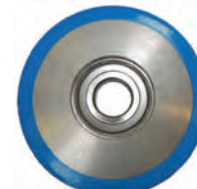

ACLAW-002

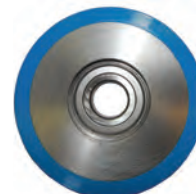

CEMW-002



KOGS-9



SCGS-15



MIS-188C



ELPW-001



ELPW-002



MIS-187A



MIS-188D



HW-5



DW-18



WW-21A



KOGS-8

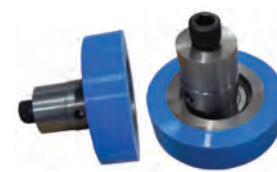

HLW-007



Guide Rollers



S.E.E.S. #	O.E.M. #	Description
OW-8	456CM4	Roller Guide wheel , 4-7/8" O.D. x 2-5/8" overall hub width. Polyurethane tire, 1" shaft, maintenance free sealed pump shaft bearing
OW-28		Roller Guide wheel , Guide Roller 4-7/8" O.D. 1-1/16" W x .7874" I.D. (2x6204)
WW-21A	M5594G02	Roller Guide wheel , 4-1/2" O.D., 1-1/4" thick with polyurethane tire, tire face 13/16", bearing .6693" I.D., double bearing
WW-21AH	M5594G02	Roller Guide wheel , 4-1/2" O.D. x 1-1/4" W .6693 I.D., HD 90 Duro
OTGS-14		Roller Guide wheel , for Guide Shoe 4.48" x 1.42" (114mm x 36mm), bearing 6203
OTGS-16		Roller Guide wheel , for Guide Shoe 4.48" x 1.42", bearing 6203 with Shaft
INCW-001		Inclinor Roller , 4.40" O.D., 5205 bearing
MW-4	P2654	Roller Guide wheel , 4-3/8" O.D. 7/8" wide with tapered face to 1/2", .7874" I.D.
DW-8	9832774, 63277	Roller Guide wheel , 4" O.D. x 1-1/4" W, tire face 1/2" W, two bearings, .6693" I.D.
DW-8H	9832774	Roller Guide wheel , 4" O.D. x 1-1/4" W x .6693" I.D., HD 90 Duro
ACW-001	TF-ACR400	Roller Guide wheel , for American Crescent, 4" O.D. x 2" Wide
ACLAW-001	140-424	Roller Guide wheel , ACLA, 3.94" x .98" (100mm x 25mm) with 6205 bearing (4" x 1")
MIS-188H		Roller Guide wheel , CTW, 3.94" x 1.18" x .79" (100mm x 30mm x 20mm), (2) 6204 Brg
SCGS-16		Roller Guide wheel , for Guide Shoe 3.94" x .98" (100mm x 25mm), bearing 6205 ID:25
MW-3	P12963	Roller Guide wheel , 3-15/16", O.D., 7/8" wide, .7874" bearing I.D.
MW-3-SUB		Roller Guide wheel , 3-15/16" x 7/8" No Bag/Label
MW-3B	P5985	Roller Guide wheel , 3-15/16" O.D. 1-1/8" wide, .7874" bearing I.D.
MW-3E		Roller Adaptor , 1-3/8" O.D. x 1/2" I.D. x 13/16" W
FJW-001	FR3187	Roller Guide wheel , 3.82" O.D. .79" I.D. (6204 Brg)
OW-3	456AK2	Roller Guide wheel , 3-3/4" O.D., polyurethane tire, sealed maintenance free bearing with 5/8" shaft
OW-9	456CN4	Roller Guide wheel , 3-3/4" O.D. x 7/8" Polyurethane tire, 5/8" hub, 1" shaft, maintenance free sealed pump shaft bearing
OTGS-5	KAA456K1	Roller Guide wheel , 3-3/4" O.D. x 7/8" Polyurethane tire, 5/8" hub, 1" shaft, maintenance free sealed pump shaft bearing
STW-001	12004A-D2A	Roller Guide wheel , 3-1/2" O.D. .79" I.D., 6204 Bearing
MIS-148		Roller Guide wheel , 3-1/2" O.D. x 15/16" W with 7/16" tire face, two bushings, bearing .7874" I.D., .673" shaft I.D., Serge CWT
HW-3	3-40150-71	Roller Guide wheel , 3-1/2" O.D. x 1-5/16" W, with 3/4" W tire face, .6693" bearing I.D.
MIS-239	3-40151-00	Roller Guide wheel , 3-1/2" O.D. x 1-5/16" W, with 3/4" wide tire face .6693" bearing I.D.
HW-9	3-40158-67	Roller Guide wheel , 3-1/2" O.D. x 1-1/16" W, with 3/4" W tire face, .5119" bearing I.D.

Guide Rollers

S.E.E.S. #	O.E.M. #	Description
HW-4	3-40196-74	Roller Guide wheel , 3-1/2" O.D. x 1-5/16" W, 1" tire face, with .7874" bearing I.D.
MIS-148B		Roller Guide wheel , 3-1/2" (no bushing)
MIS-148C		Roller Guide wheel , 3-1/2" x 1" W, .6693" I.D. 1" W Face, Double 6203 Bearing
NW-001	112-2037	Roller Guide wheel , Northern 3-1/2" Guide Roller .30" Face, .6693" I.D.
NW-001A	112-2112	Roller Guide wheel , Northern 3-1/2" Side Roller 1" Face, .6693" I.D.
NW-004	112-2113	Roller Guide wheel , Northern 3-1/2" with 1" face width, .6693" I.D.
WW-21B	M5594G04, M5594G05	Roller Guide wheel , 3-1/2" dia. with polyurethane tire, tire face 5/8", bearing .6693" I.D., double bearing
OW-204		Roller Guide wheel , 3-3/8" O.D. (3" Run dia.) .75" W, w/ 1/2-20 Ext Shaft
WW-28	694B995H01	Roller , For EZ-Oper 3-1/4" O.D. with Stud
HWW-001	377-14 377-12	Roller Guide wheel , 3-1/4" dia. H/W face roller, .420" face
HWW-001A	377-15	Roller Guide wheel , 3-1/4" dia. H/W side roller, .665" face, for HWRG-001
URGW-007		Roller Guide wheel , 3-1/4" for URG-007, 1/2" W for Face
URGW-007A		Roller Guide wheel , 3-1/4" for URG-007, 7/8" W for Side
MIS-143		Roller Guide wheel , 3-1/4" O.D. x .4724" bearing I.D. x .935" polyurethane tire, Double bearing
MIS-143A		Roller Guide wheel , 3-1/4" O.D. x .5906" bearing I.D. x .935" wide polyurethane tire, Double bearing
MIS-143AS		Roller Guide wheel , Soft Poly
MIS-143N		Roller Guide wheel , 3-1/4" x 1" W x .472" I.D., Neoprene Tire
MIS-143S		Roller Guide wheel , 3-1/4" O.D. x .4724" bearing I.D. x .935" soft polyurethane tire, Double bearing
GW-1	377-12	Roller Guide wheel , 3-1/4" O.D. with 1/2" face, 2 bearings, .6693" I.D.
GW-1A	377-13	Roller Guide wheel , 3-1/4" O.D. with 3/4" face, 2 bearings, .6693" I.D.
MW-12	513962-00F	Roller Guide wheel , 3-1/4" O.D. with two bearings, 5/8" I.D., 1/2" tire face
MW-13	513962-00S	Roller Guide wheel , 3-1/4" O.D. with two bearings, 5/8" I.D., 7/8" tire face
MW-13B		Shaft , Eccentric for MW-13, 1/2-13 Thrd
DW-15A	155804	Roller Guide wheel , 3-1/4" O.D. 1" W, 1/2" Face .669" I.D.
SDO-036	909-6008	Roller Guide wheel , ECI 3-1/4", 6203 bearing
KOGS-10	KM86789G02	Roller Guide wheel , for Guide Shoe 80mm 3.16" x 1.11" (80mm x 28mm x 2mm), bearing 6203
OW-21	A6037D1	Roller Guide wheel , 3.15" O.D., .587" W, 1/2" face, .875" I.D., aluminum
ACLAW-004	141867.06	Roller Guide wheel , ACLA, 3.15", 80mm x 25mm with 6205 bearing (25mm ID)
ACLAW-005		Roller Guide wheel , ACLA, 2.36", 80mm x 25mm with 6205 bearing (25mm ID)

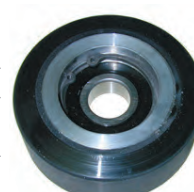

HW-4



MIS-148B



NW-001



NW-004



WW-21B



HWW-001A

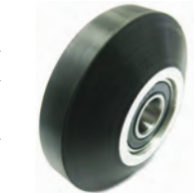

URGW-007



URGW-007A

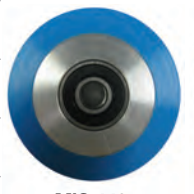

MIS-143

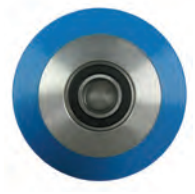

MIS-143A



MIS-143N

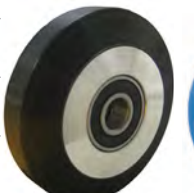

MIS-143S



GW-1



GW-1A

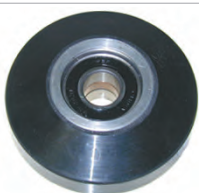

MW-12



MW-13

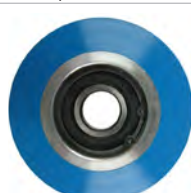

DW-15A



OW-21



ACLAW-004

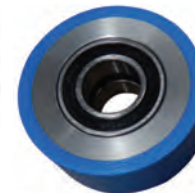

ACLAW-006

Guide Rollers

S.E.E.S. #	O.E.M. #	Description
ACLAW-006		Roller Guide wheel , ACLA, 3.15", 80mm x 30mm with 6005 bearing (25mm ID)
ACLAW-007		Roller Guide wheel , ACLA, 180mm x 35mm w/ (2) 6204 bearing (20mm ID)
ACLAW-007A		Roller Guide wheel , ACLA, 180mm x 35mm w/ (2) 6005 bearing (25mm ID)
CW-001		Carousel Wheel , 3.15" O.D., 80mm x 25mm x 17mm Delring with 6203 Bearing
CWB-001		Carousel Wheel Bumper , PPT95A
CWB-001A		Bumper Back Plate , for CWB-001
CWB-001B		Connector Assembly , for CWB-001
ETNW-001		Roller Guide wheel , ETN 50mm O.D. x 15mm W 6000 Brg, 110mm ID
ETNW-002		Roller Guide wheel , ETN 50mm O.D. x 18mm W 6003 Brg, 117mm ID
TW-002	650C003	Roller Guide wheel , Thyssenkrupp C.W. 3-1/8" O.D. x 7/8" (80mm x 22mm), .6693" I.D.
OTWH-11		Roller , 3-1/8" O.D. x .79" (80mm x 20mm) Bearing 6204
SEES-HLW-001		Roller Guide wheel , 3.132" x 1.185", Hollister Whitney
SEES-HLW-001A		Roller , 3.132" x 1.185" with Eccentric Shaft and Hdw
HLW-002	SP-000138	Roller , for Waupaca 80mm with Ecc Hex Shaft, 3-5/32"
HLW-004	M-005598	Roller , for Cemco\REI 80mm with Eccentric Hex Shaft
HLW-004A		Roller , for Cemco\REI 80mm x 35mm with Straight Hex Shaft
OW-4	456DN1	Roller Guide wheel , 3" O.D., 3/8" flat polyurethane tire face, with 1/2" N.C. threaded eccentric shaft 1" L
OW-4B	456DN3	Roller Guide wheel , shaft 2-3/8" L, 7/8" spacer, O.D. 3"
DW-15	9834734, 103473	Roller Guide wheel , 3" O.D., .668" Bearing I.D., for roller assembly #103477
MIS-188K		Roller Guide wheel , 3" O.D. x 7/8" Face 1-3/16" W, (2) R12RS (3/4" Bore)
MIS-187	M1286	Roller Guide wheel , 3" O.D. x .5906" bearing I.D. x 1" W tire. Double bearing. Tire face 3/8"
MW-2	P2964	Roller Guide wheel , 3" O.D., 1/2" tire face, .7874" bearing I.D.
WW-20	144A277G01	Roller Guide wheel , 3" diameter, .6693" I.D., 1" thick
WW-20A	144A277G02	Roller Guide wheel , 3" .6693 bore, steel hub
WW-20AH	144A277G02-H	Roller Guide wheel , 3" .6693 bore, steel hub, hard poly
SCWH-20		Roller , 76mm x 25mm, 6204
FJWH-1		Roller , 75mm x 23.5mm, 6204, 2.95" O.D.
FUJ-078		Pressure Roller , 75mm x 70mm x 20mm I.D. (6004 Brg)
TOWH-4		Roller Guide wheel , with Plastic roller, 2-7/8" x 7/16" 73mm O.D. x 11mm I.D. 6200 bearing
MW-13A		Roller Guide Wheel , 2-7/8" O.D. Piston Follower Double 99502H bearing 5/8" Bore
SCWH-5		Roller Guide wheel , Nylon Aluminum Hub Handrail Roller 2.75" (70mm*50mm)
DW-11	9819745	Roller Guide wheel , 2-5/8" O.D. counter weight, Omega
TW-001	9819745	Roller , Thyssen Counter Weight, 2.625" diameter, .6693" I.D., 90 Duro
DCW-002	60400011	Roller Guide wheel , Revolver Boone Olster 2-9/16" O.D. x 3/4" W, 6205 Bearing
MIS-221		Roller Guide wheel , 2.5" home lift, 1/2" I.D., 2-1/2" O.D., 1.485" bearing I.D.
ACW-002	TF-ACR25	Roller Guide wheel , for American Crescent, 2-1/2" O.D. x 2" Wide
ACW-003	TF-ACR25	Roller Guide wheel , for American Crescent, 2-1/2" O.D. x 1" Wide



ACLAW-007



ACLAW-007



HLW-002



HLW-004



OW-4

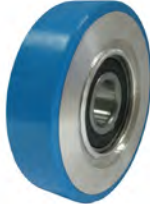

DW-15



MIS-188K



MIS-187



MW-2



WW-20



WW-20A



SCWH-20

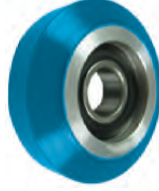

DW-11



DCW-002

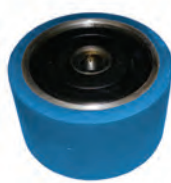

MIS-221

Miscellaneous Rollers

S.E.E.S. #	O.E.M. #	Description
ACW-002	TF-ACR250	Roller , for American Crescent, 2-1/2" O.D. x 2" Wide
ACW-003	TF-ACR251	Roller , for American Crescent, 2-1/2" O.D. x 1" Wide
CEMW-001		Cemco Coupling Roller , Roller Only, 1-15/16" O.D. x 1-1/8" I.D.
DW-1	9838351, 63835	Roller kit , 1-5/8" diameter roller, nylon bushing and retaining ring
DW-1S		Pickup Roller , with Shaft and Retaining Ring
DW-1-P	D-803R1-POLY	Roller kit , 1-5/8" O.D. Poly Blue with Bushing and ring
DW-1-PS	D-803R1-POLY-SOFT	Roller kit , 1-5/8" O.D. Poly Black - Soft with Bushing and ring
FJLO-5		Wheel , For Door Lock 38mm O.D. 16mm W, 14mm I.D.
FJLO-6		Wheel , For Door Lock 30mm O.D. 16mm W, 14mm I.D.
HLW-001		Roller , 2-3/8" O.D. x 1-3/16" W
HLW-001E		Roller , for OLS, 2-3/8" O.D. x 1-3/16" W w/ Eccentric Hex Shaft
HLW-003	M-005598	Roller , for Waupaca 60mm with Straight Hex Shaft
HLW-005		Roller , for Garaventa 2-1/4" O.D.
HLW-005A		Roller , for Garaventa 2-1/4" O.D. .765" W, with Straight Shaft
HLW-006		Roller , for Cheney 2.43" O.D. x .595" W, with Straight Shaft
HLW-008		Hanger Roller , for Savaria 3.375" O.D. x 5/8" with Shaft
KOOL-SM2093		Sematic Roller , Radius Groove, M6 Shaft, 60mm O.D. x18mm wide
KOOL-SM2094		Sematic Roller , Radius Groove, M8 Shaft, 36/30mm O.D. x18mm wide
HLW-008		Hanger Roller , for Savaria 3.375" O.D. x 5/8" with Shaft
MOT-WH-5		Wheel , Tach for 1/2" Shaft
OW-205		CW Roller , Convex Tire 2.20" O.D. x 7/8" W x .370" I.D.
REW-001		Roller , for Residential elevator, 3" O.D. x 1-1/2" W with Shaft
SDO-008B	611010220	Roller/Axle Assembly , 30mm x 10mm for Schindler QKS9, D30, 1.18" O.D.
SEMW-001		Sematic Roller , 36/30mm O.D. x 18mm Wide Radius Groove, M8 Shaft
SEMW-002		Sematic Roller , 60mm O.D. x 18mm Wide Radius Groove, M6 Shaft
THLO-1		Roller , for Door Lock 30mm x 20mm ID:15, 1.18" O.D.



ACW-002



HLW-001

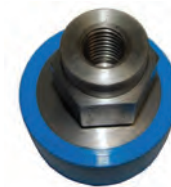

HLW-001E



HLW-003



DW-1

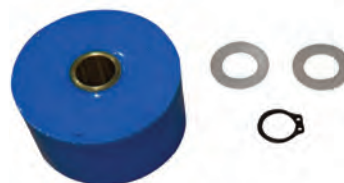

DW-1-P

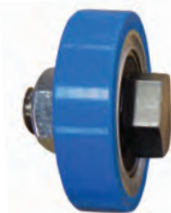

HLW-006



FJLO-5



FJLO-6

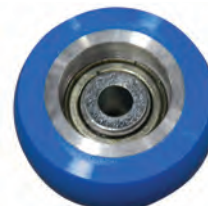

OW-205



CEMW-001



WW-4



AW-1



AW-3



DW-2A

DW-3A



WW-1

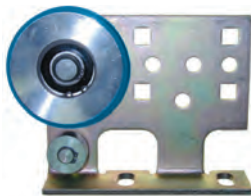

WW-7RH

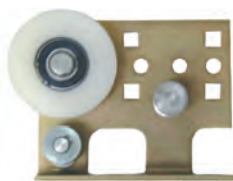

WW-7RH NYLON



WW-14LH



OW-23

Hanger Assemblies

S.E.E.S. #	O.E.M. #	Description
WW-4	T5409G99	Hanger assembly, complete, with WW-5, 4-3/8" O.D.
WW-11RH	324C083G99	Hanger assembly, complete, R.H., with WW-12, 4-1/4" O.D.
WW-11LH	324C083G99	Hanger assembly, complete, L.H. with WW-12, 4-1/4" O.D.
HW-18	3-40155-59	Door Hanger & Roller, Assembly with 3-5/16" roller
DW-3A	9838533	Hanger assembly, high pocket, consists of mounting bracket DW-3B, hanger roller DW-3, 3-5/16" O.D., and eccentric upthrust shaft DW-9, with roller tire assembly DW-10
AW-1	12103-01, B733004	Hanger assembly, with 3-1/4" steel roller
DW-3-AL	9864295-AL	Hanger assembly, 3-5/16" Alum Hub 90 Duro Urethane
AW-3	12103-01, B733004	Hanger assembly, with 3-1/4" polyurethane roller
DW-2A	9838340	Hanger assembly, low pocket, consists of mounting bracket DW-2B, hanger roller DW-2, 2-7/8" O.D. and eccentric upthrust shaft DW-9, with roller tire assembly DW-10
WW-1	T5411G99	Hanger assembly, 3-3/8" O.D., complete for flat track
WW-1R	T5411G99	Hanger assembly, For Round Track 3-3/8", Individual -Round
WW-14LH-P	W408L-POLY	Hanger assembly, L.H. with Poly Roller, 2-3/4" O.D.
WW-14RH-P	W408R-POLY	Hanger assembly, R.H. with Poly Roller, 2-3/4" O.D.
WW-14LH-PR	W408L-POLY-R	Hanger assembly, L.H. with Poly Roller, Reversed (Backside), 2-3/4" O.D.
WW-14RH-PR	W408R-POLY-R	Hanger assembly, R.H. with Poly Roller, Reversed (Backside), 2-3/4" O.D.
WW-7RH	M7405G99	Hanger assembly, complete, R.H. with WW-18, 2-3/4" O.D.
WW-7LH	M7405G99	Hanger assembly, complete, L.H. with WW-18, 2-3/4" O.D.
WW-7RH-NYLON	M7405G3, G5	Hanger assembly, complete, R.H. with WW-17 nylon roller, 2-3/4" O.D.
WW-7LH-NYLON	M7405G4, G6	Hanger assembly, complete, L.H. with WW-17 nylon roller, 2-3/4" O.D.
WW-14RH	325C798G01	Hanger assembly, complete, R.H., with WW-15, 2-3/4" O.D.
WW-14LH	325C798G02	Hanger assembly, complete, L.H., R.H., with WW-15, 2-3/4" O.D.
OW-23	389J	Hanger assembly, for Type B & 7087, OW-13A, 2-3/4" O.D.

Hanger Assemblies

S.E.E.S. #	O.E.M. #	Description
OW-19	B6037B6	Hanger assembly , 2-1/4" O.D., for hoistway, includes heavy bracket OW-19A, B6037B1 rollers and wiper
GDO-2A	HH10-0041N, OS-NM	Hanger Assembly , includes; nylon wheel 2-1/4" O.D. x 9/16", mounting bracket and hardware required to replace "old style" s steel roller
KOOL-KN-2021	KN2021	Roller , Hanger ADM/ADR 70mm x 17mm with Shaft
SCHR-2A		Hanger assembly , 1.57" x .35", 40mm x 9mm Straight Bracket only
SCHR-2B		Hanger assembly , 1.57" x .35", 40mm x 9mm Straight Bracket with Hardware
SCHR-3A		Hanger assembly , 1.57" x .35", 40mm x 9mm Offset Bracket
SCHR-3B		Hanger assembly , 1.57" x .35", 40mm x 9mm Offset Bracket, with Counter Sunk Holes



OW-19

SEES, INC.

SAVE BIG ON SUPPLIES

Everything you need for an elevator inspection.



SEES-WC-002
SEES Weight Test Cart, 500lbs

SEES-TOOL-002

Voltage Detector with Light



MIS-211
Door Pressure Gauge



SEES-HYD-PG-007
SEES Pressure Gauge Kit

Hydraulic Elevator - Periodic Test Tag						
Person or Firm Performing Test:						
Periodic Test Category: 1						
A17.1-2007 & later	A17.1a-2008 & later	Test Item	Test Date	Test Date	Test Date	
A17.1.2.2	A17.1.2.2	Periodic Valve & System Pressure				
A17.1.2.3	A17.1.2.3	Control & Protection Wiring				
A17.1.2.4	A17.1.2.4	Normal Stop/Retaining Device				
A17.1.2.5	A17.1.2.5	Governors				
A17.1.2.6	A17.1.2.6	Guides				
A17.1.2.7	A17.1.2.7	Oil Leaks				
A17.1.2.8	A17.1.2.8	Emergency Operation P.P.S.				
A17.1.2.9	A17.1.2.9	Standby Power Operation				
A17.1.2.10	A17.1.2.10	Power Operation of Doors				
A17.1.2.11	A17.1.2.11	Terminal Speed Enforcement				
A17.1.2.12	A17.1.2.12	Low Oil Protection				
A17.1.2.13	A17.1.2.13	Rescue Hoist & Lifting				
A17.1.2.14	A17.1.2.14	Provision of Power				
A17.1.2.15	A17.1.2.15	Provision of Power Operation of				
A17.1.2.16	A17.1.2.16	Door System				
A17.1.2.17	A17.1.2.17	Block Repair Device				

MIS-166HT

Test Tag, Hydro Elevator 4x6 A17.1-2007 & A171a-2008



SEES-DWT-001

SEES Door Wedge Tool, Poly with Key Chain



SEES-JUMPER-001

SEES Jumper Kit, used for temporarily jumping out circuits while under repair. Jumper test lead with pouch, includes alligator clip, spring loaded plunger, and lug terminal.



WR-MT

Wire rope measuring gauge, for imperial sizes, go/no go style, use on rope diameters 3/8", 7/16", 1/2", 9/16", 5/8", 11/16" and 3/4"



HYD-PSW-002

Pressure Switch, Low Pressure 15-150 PSI Range, 250V Max.



Always Smooth Sailing



2781 West McNab Rd., Pompano Beach, FL 33069 • 800-526-0026 • www.SEESinc.com

SOUTHERN ELEVATOR & ELECTRIC SUPPLY

Hanger Rollers

S.E.E.S. #	O.E.M. #	Description
HIW-3		Hanger Roller , 5.12" O.D., 130mm x 30m with 15mm I.D. Double 6202
WW-5	R8636G98, R8636G01	Hanger roller , 4-3/8" diameter, 1-1/8" bearing, aluminum with polyurethane tire, fits square rail
MIS-188B		Hanger Roller , 4.25" O.D. x .60" W with 6204 brg (.7874" I.D.) Westinghouse
WW-12	323C235G02	Hanger Roller , 4-1/4" diameter, 6204" bearing .7874" I.D., aluminum with polyurethane tire
WW-12N	323C235G01	Roller , Nylon 4-1/4" O.D. with .7874" I.D.
STW-003	ST343	Hanger Roller , 3.812" x .875" .6693" I.D. (6203 Brg)
KOHR-1		Roller , Hanger 3.7" x .75" (94mm x 19mm), bearing 6203 groove diameter 84.5mm
KOHR-6		Roller , Hanger with Eccentric 3.7" x .75" (94mm x 19mm), bearing 6203, groove diameter 84.5mm
HW-7	3-40157-63	Hanger Roller , 3-11/16" diameter with .6299" bearing I.D.
MW-8	MAP344, P31344	Roller , Car door roller, 3-11/16"
MW-8E	P022237	Roller , Car door roller, 3-11/16", with eccentric shaft
HW-2	3-16847-01	Door Hanger Roller , nylon, 3-11/16" O.D. x 3/4" wide, .6299" bearing I.D.
MIS-143B	03-018-037	Hanger Roller , ESCO 3-11/16" 3-1/4" Run O.D. Bushing
MIS-143C	A406AM, 03-018-08	Hanger Roller , ESCO 3-11/16" 3-1/4" Run O.D. without bushing
OTHR-2		Roller , Hanger, 3.54" x .71" (90mm x 18mm)
OTHR-1		Roller , for Hanger Assembly 3.39" x .79" (86mm O.D. x 20mm), bearing 6204 ID:20mm
KOHR-18		Roller , Hanger 85mm x19mm, bearing 6203Z, 3.35" W
MIS-195		Door Hanger Roller , Williamsburg Style, 3-3/8" O.D., x 7/8" W steel roller with flat nylon track 1/2", eccentric threaded shaft 1/2-20 fine x 3/4" long
MIS-195A		Door Hanger Roller , 3-3/8" O.D., x 7/8" W steel roller with convex nylon track, 1/4" radius tire face with eccentric threaded shaft 1/2-20 fine x 3/4" long
MIS-195B		Roller , 3-3/8" O.D. with 1/4" Radius, 3" Running dia. 1/2-20 Eccentric Shaft, no Plate
MIS-195C		Roller , 3-3/8" O.D. with 1/4" Radius, 3" Run dia. 5/8-18 Eccentric Shaft, *Recessed Hub on Both Sides
OW-40		Hanger Roller , 3-3/8" Poly 6203 with Eccentric Shaft 7/16-20
OW-40A		Hanger Roller , 3-3/8" Poly 6203 w/ Straight Shaft 7/16-20
WW-2	R8858G01	Hanger Roller , 3-3/8" diameter, R8858G01 aluminum with polyurethane tire, 6204 bearing
HW-14	AR928A3	Hanger Roller , 3-3/8" diameter, eccentric shaft 5/8"
HW-14A		Hanger Roller , 3-3/8" O.D. with Spec Eccentric
OW-12	456CX4	Door Hanger Roller , 3-3/8" O.D. x 13/16", .7874 bore I.D., with 11/32" radius on concave polyurethane tire surface
OW-12A		Door Hanger Roller , 3-3/8" O.D. x 13/16", .7874" I.D., all steel construction for flat track
OW-12C		Door Hanger Roller , 3-3/8" O.D. x 13/16", .7874" I.D., aluminum with polyurethane tire for flat track
OW-12S		Door Hanger Roller , 3-3/8" O.D. x 13/16" .7874" I.D., steel with polyurethane tire for flat track



HIW-3

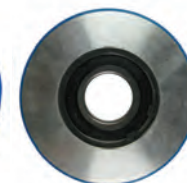

WW-5



MIS-188B



WW-12



WW-12N



KOHR-1



KOHR-6

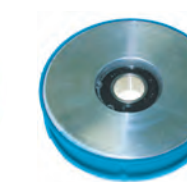

HW-7



MW-8



MW-8E



HW-2



OTHR-2



OTHR-1



KOHR-18



MIS-195



MIS-195C



OW-40



HW-14



HW-14A

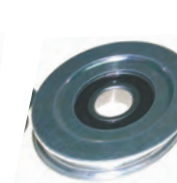

OW-12A



Hanger Rollers

S.E.E.S. #	O.E.M. #	Description
OW-1	456DH1	Door Hanger Roller, 3-3/8" O.D. x 13/16" poly tire with eccentric, 1/2" NF threaded shaft
OW-1BA		Door Hanger Roller, 3-3/8" O.D. Flat/Radius, Roller Only
OW-1E	AAA456YA1/ AAA456YA3	Door Hanger Roller, 3-3/8" Flat/Rad with Ecc Shaft M12 Thrd
OW-1E-A		Hanger Roller, 3-3/8" Flat/Rad w/ Ecc Shaft Reversed
OW-1S		Hanger Roller, 3-3/8" O.D. Steel, Flat Track with eccentric
MDW-001		Modern Elevator Hanger Roller, 3-3/8" O.D. Flat Track
OW-1B		Hanger Roller, 3-3/8" O.D. Flat / Radius, w/ OW-13B
OW-1C		Hanger Roller, 3-3/8" O.D. Flat / Radius, with Shaft
OW-1D	456EW1 456EW2	Hanger Roller, 3-3/8" Flat / Rad with Ecc. Shaft 1/2-20 Thread
MIS-TYL-001		Hanger Roller, Tyler, 3-5/16", with eccentric
MIS-TYL-001B		Hanger Roller, Tyler, 3-5/16", with HW-14 Eccentric
MIS-TYL-002		Tyler Bearing, with eccentric and hardware
MIS-TYL-003		Roller, 3-5/16" with Eccentric Medium Poly
MIS-TYL-005		Hanger Roller, 3-3/8" with ecc. 6204 Brg, 5/8-18 Thread
MIS-TYL-005A		Hanger Roller, Tyler, 3-3/8" without Eccentric Shaft 6204 Brg
MIS-TYL-006		Hanger Roller, 3-3/8" with ecc. 6204 Brg
MIS-TYL-006A		Door Gib, with Brass Insert & Mgt. Screw
MIS-TYL-007		Door Gib Kit, Gib, Bracket # Hdw
KW-005		Roller, Hanger 3-5/16" O.D. x .6693" I.D., with 7/16-20 Shaft
KW-005E		Roller, Hanger 3-5/16" O.D. x .6693" I.D., with 7/16-20 Ecc. Shaft
KOOL-OT2036	OT2036	Hanger Roller, OTIS, Europa 70mm
DW-3	9864295	Hanger Roller, .6693" I.D., steel with polyurethane tires, 3-5/16" diameter
HW-6	3-40130-77, 3-40130-79	Hanger Roller, for B-4 hanger, 3-5/16" O.D. with .625" bearing I.D.
MIW-001	MBH331	Hanger Roller, Flat Track 3.312" O.D. x .687" I.D.
AW-11		Sheave, 3-3/8" O.D., .6693 I.D., #7 Car door hanger For concave track
OW-2	456W1	Door Hanger Roller, 3-1/4" O.D. x 11/16" with .9841 bore I.D., polyurethane tire
OW-18	A456EA1	Steel Hanger Roller, for 6178A assembly 3-1/4" O.D. x 11/16", bore 1/2"
OW-11S	A456W1	Door Hanger Roller, 3-1/4" O.D. x 11/16", 1/2" I.D. steel roller with polyurethane tire
DW-17	9861245	Roller, hanger, 3-1/4" O.D. aluminum wheel with urethane tire for assembly #66137
OW-18A	A456EA1	Hanger Roller, 3-1/4" O.D. 11/16" wide, for 6178A assembly steel with polyurethane tire
DALW-002E		Hanger Roller, 3-1/4" O.D. with Ext Ecc. Shaft, 6203
SCHR-050		Hanger Roller, 3-3/8" O.D. x .80 W with Eccentric 5/8-18 Shaft

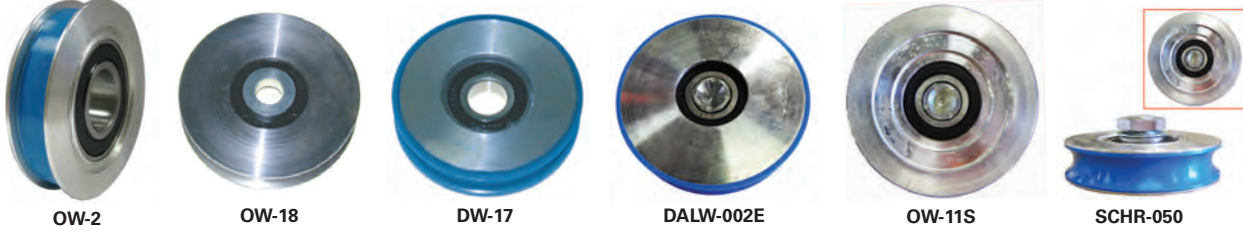

Hanger Rollers

S.E.E.S. #	O.E.M. #	Description
GDO-2S		Hanger Roller , 3-1/4" O.D. Steel Hub with Poly Tire
BW-001		Hanger Roller , Beckett 3-1/4" x .6693" I.D. w/ Shaft
BW-001A		Hanger Roller , Alum, Beckett 3-1/4" x .6693" I.D. with shaft
BW-001AE		Hanger Roller , Alum, Beckett 3-1/4" x .6693" I.D. with eccentric shaft
BW-002AE		Hanger Roller , Alum, Beckett 3-1/4" x .6693" I.D., Ext Ecc-Shft
GDO-2	456DH4	Door Hanger Roller Kit , 3-1/4" diameter roller with bushing and HH1-0025N hardware kit, aluminum hub with polyurethane tire
GDO-2-INSERT		Reducer Bushing , 1/2" I.D. insert for GDO-2, 2N and 2S
GDO-2B		Door Hanger Roller , 3-1/4" diameter roller, aluminum hub with polyurethane tire. Used in GDO-2
GDO-2C	G401AM	Hanger Roller , 3-1/4" O.D. x .6693" I.D. with axle stud
GDO-2N	HH1-0025N	Door Hanger Roller Kit , 3-1/4" diameter roller with wiper, steel hub with nylon tire
GDO-2N-KIT		Door Hanger Roller Kit , 3-1/4" diameter roller with wiper and hardware kit, steel hub with nylon tire
GDO-2N-SET		Door Hanger Roller Set , 3-1/4" O.D. Nylon with Wiper, Hdw, Bushing
GDO-2SKW-B	HH5-0028N	Door Hanger Roller Kit , 3-1/4" steel roller with Type "C" wiper & hardware
GDO-2SK		Hanger Roller , 3-1/4" O.D. with hardware, steel version, made of GDO-2S and GDO-2-XHDW-KIT
FJW-002	FH325	Hanger Roller , 3.25" O.D. with Ecc. .7874" I.D. (6204 Brg)
MEHR-001	30008565	Roller , Meiller Door Hanger 65mm x 17mm 6201 Radius Track, Single Groove
MEHR-002	30008566	Roller , Meiller Door Hanger 65mm x 21mm 6201 Radius Track, Double Groove

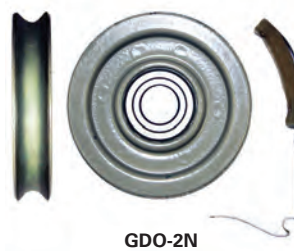
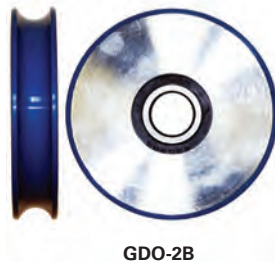
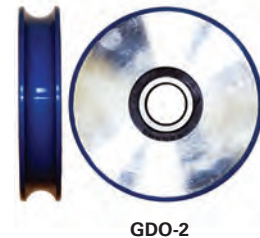
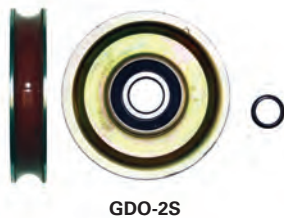



Hanger Rollers

S.E.E.S. #	O.E.M. #	Description
MIS-EW-001		Hanger Roller, ERM Nylon 3.135" O.D. x .6693" I.D. x .720" Wide
WW-19A	7266C866G01	Steel Hanger Roller, 3" dia.
FUJ-072	D00403001	Door Hanger Roller, O.D. 3" (76mm) x .67" (17mm)
SCHR-1		Roller for Hanger, O.D. 3" (76mm)
SCHR-2		Roller for Hanger, 2.95" x .47" (75mm x 12mm), straight panel
SCHR-3		Roller for Hanger, 2.95" x .47" (75mm x 12mm)
SCHR-052		Hanger Roller, Varidor 30, 2.91" x .71", 74/63mm x 18mm, with Shaft/Bush
MW-7	MAP341	Roller, Hatch door roller, 2-7/8"
DW-2	9838302, W-417	Hatch Door Hanger Roller, 2-7/8" dia., .6693" I.D. 63830) aluminum with polyurethane tires
DALW-001E		Hanger Roller, 2-7/8" O.D. with Ext Ecc. Shaft, 6203 Brg
DCW-001		Carroage Hanger Roller, 2-7/8" O.D., Alum with Poly
DCW-004	412498	Roller, Duraglide 1000 Load Wheel Assy, Rev P5
SCHR-8		Roller for Hanger for AD9 2.83" x .59" (72mm x 15mm) GD:64, bearing 6200
HIHR-6		Roller, Freight Lift Hanger 2.76" x .79" (70mm x 20mm) GD:64, 6204 ID:20mm
TOWH-3		Roller, 2-3/4" diameter, nylon roller
WW-17A		Roller, Nylon 2-3/4" O.D. x .6693" bore, 6203 bearing
OW-13	456CC1	Steel Door Roller, 2-3/4" O.D. x 3/4", .7872" bore I.D. (for OW-23)
OW-13A	456CC1	Door Roller same as above but with polyurethane tire (for OW-23)
OW-32		Hanger Roller, 70mm x 14mm x 8mm
WW-15	325C798G09	Aluminum Roller, 2-3/4" dia.
WW-18	576B535G98	Hanger Roller, 2-3/4" diameter, aluminum with poly tire
WW-15A		Aluminum Roller, 2-3/4" dia., .600" thick
WW-17	576B535G04	Nylon Roller, 2-3/4" dia., .5906" I.D.
WW-18S	576B535-G98	Hanger Roller, 2-3/4" Steel with poly, .5906" I.D.
OW-13AW		Hanger Roller, 2-3-4" O.D., Flat track (wide)
WW-15P	W-408W1-POLY	Hanger Roller, Alum w/ Poly 2-3/4" O.D. for WW-14LH/RH-P
THHR-1		Roller for Door Hanger 70mm x 17mm (2.76" x .67"), bearing 6200 ID:10 GD:62
THHR-2		Roller for Door Hanger 70mm x 17mm (2.76" x .67"), bearing 6200 ID:10 GD:62
FJHR-1		Hanger Roller, 2.68" O.D. x .55" W, bearing 6202
KOHR-16		Roller, Hanger 2.68" x .67" (68mm x 17mm), bearing 6203Z
HW-8	3-40157-60	Hanger Roller, 2-5/8" diameter with .6299" bearing I.D.
HW-15	35-727-30	Door Clutch Roller, 2-9/16" O.D. x 3/4" wide with 5/8" bearing I.D., for door clutch arm R.H. or L.H.
HIHR-1		Roller, Hanger 2.56" x .51" (65mm x 13mm), bearing 6202RS, GD:60 ID:15mm

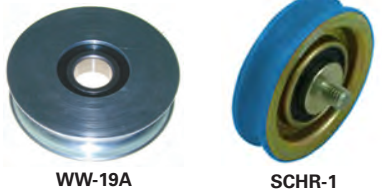

WW-19A

SCHR-1

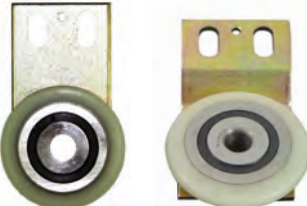

SCHR-2

SCHR-3

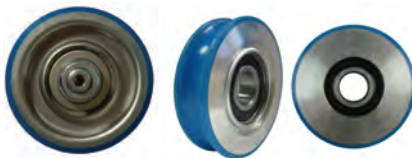

MW-7

DW-2



DALW-001E

SCHR-8

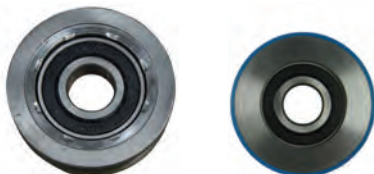

HIHR-6

OW-13A



WW-18

WW-15

WW-15A

WW-17



WW-18S

WW-15P

KOHR-16

HW-8

HW-15

HIHR-1

Hanger Rollers

S.E.E.S. #	O.E.M. #	Description
KOWH-20		Roller , for SELCOM Hanger 2.52" x .43" (64mm x 11mm), bearing 6202 ID:10
KOWH-20A		Hanger Roller , SELCOM 86mm x 16mm, 6203 Brg
KOHR-27		Roller , Pulley, 2.52" x .354" (64mm x 9mm 8mm I.D.), Counterbore Shaft
KOHR-3		Roller , Nylon Hanger 2.44" x .63" (62mm x 16mm), bearing 6203 groove diameter 52mm, ID:17mm
KOHR-14		Roller , Hanger 2.35" x .51" (59.6mm x 13mm), bearing 6002Z
KOHR-15		Roller , Hanger 2.35" x .51" (59.6mm x 13mm), bearing 6002Z
GDO-2AP		Hanger Roller , 2-1/4" O.D. Alum Hub with Poly Tire
HW-1A	3-16497-00	Roller Guide Assembly , door clutch, 2-1/4" O.D. x 9/16" face with 7/16" bore
KOHR-2		Roller , Hanger 2.20" x .61" (56mm x 15.5mm), bearing 6202
KOHR-28		Roller , Hanger 2.20" x .55" (56mm x 14mm) with Integral Shaft
KOHR-17		Roller , Hanger 2.19" x .79" (55.5mm x 20mm), bearing 6202Z
SCHR-7		Roller , for Hanger 2.13" x .71" (54mm x 18mm) GD:48, bearing 6200 ID:10
SCHR-11		Roller , for Hanger 2.13" x .79" (54mm x 20mm) GD:48, bearing 6200 ID:10
OW-20	456FC1	Hanger Roller , LRV, 2" O.D.
OW-17	456CE4	Roller with eccentric shaft, 2" O.D. x 9/16" with threaded shaft 1/2-20
KOWH-21		Roller , 1.98" x .47" (50mm x 12mm), bearing 6002
KOWH-22		Roller , 1.89" x .34" (48mm x 9mm), bearing 608, GD:40 ID:8
OTHR-4	XAA520C1	Roller , for hanger, 84 mm, 3.3" O.D.
OTHR-6	FOC2215Z137	Orly Roller , Door Hanger, D50/40mm x 15mm M10 Eccentric Stud
KOHR-12		Roller , Eccentric for Hanger 1.80" x .67", bearing 6201, groove diameter 39mm
KOHR-7		Roller , Retainer for Hanger 1.80" x .63", bearing 6001, groove diameter 39mm, 6G-M12
KOHR-4		Roller , Nylon Hanger 1.73" x .47" (44mm x 12mm) M8, groove diameter 38mm, ID:12mm
KOHR-9		Roller , for Hanger 1.73" x .63" (44mm x 16mm) groove diameter 38mm, M10
KOHR-8		Roller , Retainer for SELCOM Hanger 1.69" x .63", bearing 6202 with Eccentric Shaft
KOHR-26		Roller , Hanger, 1.42" x .55" (36mm x 14mm) with Eccentric Shaft 10mm Thrd



KOWH-20

KOHR-3

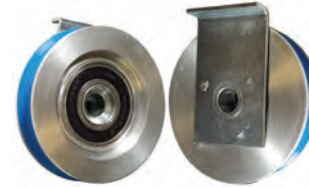

KOHR-14



KOHR-15



GDO-2AP

HW-1A



KOHR-2

KOHR-17



SCHR-7

SCHR-11

OW-20



OW-17

KOWH-21

KOWH-22

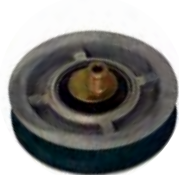

OTHR-4



KOHR-12



KOHR-7



KOHR-4



KOHR-9



KOHR-8



Bearings

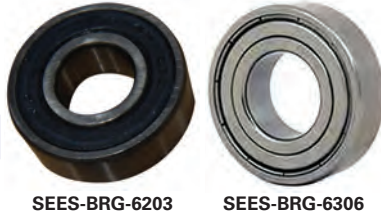

SEES-BRG-6203

SEES-BRG-6306



MIS-152



MIS-233



MIS-233A



MIS-233B



MIS-233C



MIS-233D



MIS-233E



MIS-233F



MIS-233G

S.E.E.S. #	Description	S.E.E.S. #	Description
SEES-BRG-608	Bearing, 608-ZZ	SEES-BRG-6201	Bearing, 6201-2RS
SEES-BRG-1602	Bearing, 1602-ZZ	SEES-BRG-6201-8	Bearing, 6201-2RS-8
SEES-BRG-1614	Bearing, 1614-2RS	SEES-BRG-6202-10	Bearing, 6202-2RS
SEES-BRG-1621	Bearing, 1621-2RS	SEES-BRG-6203	Bearing, 6203-2RS
SEES-BRG-5200	Bearing, 5200-2RS	SEES-BRG-6204	Bearing, 6204-2RS
SEES-BRG-5201	Bearing, 5201-2RS	SEES-BRG-6205	Bearing, 6205-2RS
SEES-BRG-5204	Bearing, 5204-2RS	SEES-BRG-6206	Bearing, 6206-2RS
SEES-BRG-5205	Bearing, 5205-2RS	SEES-BRG-6208	Bearing, 6208-2RS
SEES-BRG-5304	Bearing, 5304-2RS	SEES-BRG-6302	Bearing, 6302-ZZ
SEES-BRG-6000	Bearing, 6000-2RS	SEES-BRG-6304	Bearing, 6304-ZZ
SEES-BRG-6001	Bearing, 6001-2RS	SEES-BRG-6305	Bearing, 6305-ZZ
SEES-BRG-6002	Bearing, 6002-2RS	SEES-BRG-6306	Bearing, 6306-ZZ
SEES-BRG-6003	Bearing, 6003-2RS	SEES-BRG-6800	Bearing, 6800-ZZ
SEES-BRG-6004	Bearing, 6004-2RS	SEES-BRG-99502H	Bearing, 99502H
SEES-BRG-6200	Bearing, 6200-2RS	SEES-BRG-R12	Bearing, R12-2RS
		SEES-BRG-R4	Bearing, R4-2RS

S.E.E.S. #	Description
SEES-BRG-6203NR	Bearing, 6203-2RSNR with Retaining Ring
SEES-BRG-6202NR	Bearing, 6202-2RSNR with Retaining Ring
SEES-BRG-99502HNR	Bearing, 99502HNR with Retaining Ring

Slide Guides

S.E.E.S. #	O.E.M. #	Description
ASCH-001-4		Slide Guide for ACSH-001
DDO-2	9838685	Slide Insert for DDO-21 assembly 2-1/2" L x 3/4" W
DDO-13	9805266, 10526	IVO Slide Guide Shoe, 5-1/2" x 1", 3-1/2" c/c mtg., used with DDO-13C Holder
DDO-21	9838697, 63869	Slide Assembly Complete
DDO-21A		Bracket and Bearing for slide assy DDO-21
DDO-21B	9806623	Slide Holder for DDO-21 assembly
DDO-44	9787768, 108768	Slide Guide, IVO "L" Shape
GGG-001		General Guide Shoe Insert, 15# Rail 5.625" L x 1" W
KM-001	KM-433371H29	Shoe Insert, folding slide
MIS-152		Nylon Gib, long wearing, self lubricating. 8-1/2" L x 1-11/16" W x 1-1/2" H, Slot: 1" D x 5/8" W
MIS-233	8S	Guide Shoe Assembly, Esco fixed, 5/8" rail with insert
MIS-233A	8ST	Slide Guide, Stile Style, Mount Fixed, 5/8" rail
MIS-233B	815DS	Slide Guide Assy, Double Swvlv Self Aligning, 10,000 Lbs Cap
MIS-233C	816DS	Slide Guide Assy, Double Swvlv Self Aligning, 10,000 Lbs Cap
MIS-233D	815SS	Slide Guide Assy, Single Swvlv Self Aligning, 8,000 Lbs Cap
MIS-233E	816SS	Slide Guide Assy, Single Swvlv Self Aligning, 10,000 Lbs Cap
MIS-233F		Guide Shoe Insert, 5-7/8" x 1-11/64 x 63/64, M10 x 1.5
MIS-233G		Guide Shoe Insert, 5/8" Rail, 6.25" L x 1.50" W x 1.625" with lip
MIS-233H	18FR	Freight Duty Fixed Guide Assembly, for 3/4" Rail
MIS-233J		Guide Shoe Insert, 1-3/8" x 1-3/8" x 9" L for 5/8" Rail
MIS-233K	30SS	Guide Shoe, Freight Duty 1.25" Rail
MIS-233L	16SS	Guide, Slide 20K/Car SS 3 x 5.5 Mount
ODO-79D	380CE1	Insert, Slide Guide 6 Knob Folding Type
SEES-HL-001G		Replacement Slide Guides for SEES Home Lift

ARMOR

QUICK LOCATOR GUIDE

Belts	520, 534
Brake Components	534
Brushes	515
Capacitors	522
Car Signal Components	512-514
Gongs	514
Emergency Stop Switch	514
Lamps and Lamp Sockets	514
Lock Cylinders and Keys	514
Pushbutton Assemblies	512-513
Toggle Switches	514
Coils	516-517
Door Parts and Equipment	518-521
Cables	520
Clutch Components	521
Door Key	520
Door Roller Assemblies	518-520
Gibs	521
Interlock Components	518-519
Interlock Jumper	520
Operator Components	521
Safety Edge Parts	519-521
Spirator, Reel Closer	520
Machine Seals and Bearings	534
Printed Circuit Boards	522
Rectifiers	523
Relays	532-533
Relay Parts	524-531
No. 1 Stepping Relay	524
No. 1 Relay, No. 1 Contactor	525-526
No. 2, 2A Relay	527-528
No. 3, 3A Contactor	529-530
No. 5A Contactor	531
Resistors	523
Selector Parts	535
Switches	533
Transformers	536-537
Wheels and Rollers	537-538
Door Rollers & Roller Assemblies	537
Hanger Assemblies	538
Hanger Wheels	538

Car Signal Components

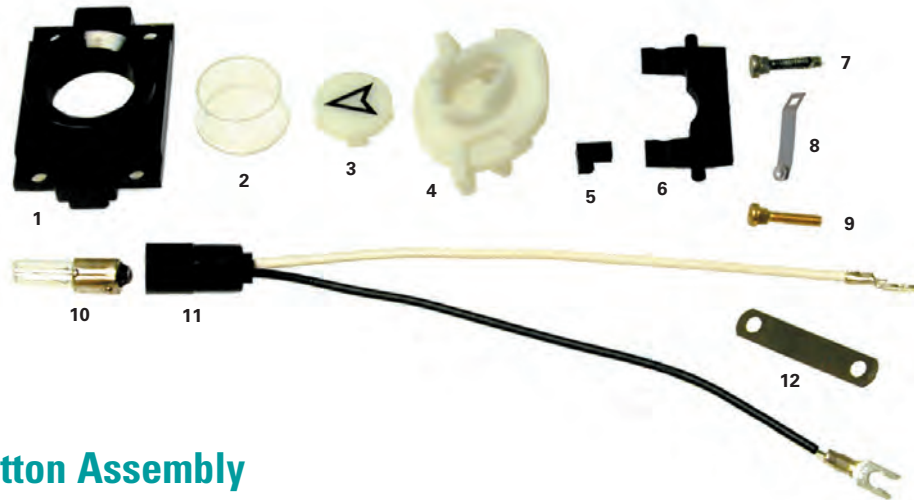

Pushbutton Assembly

Item	S.E.E.S. #	O.E.M. #	Description
1-12	APB-1-	PB-46	Pushbutton assembly complete. Standard assembly is furnished with black halo APB-6 and white round button marked with arrow APB-1-ARROW. Available sub-assembly components are shown above. Specify marking i.e. APB-1-ARROW
1	APB-4	11146-02	Halo , black with 1" diameter round collar
	APB-5	11143-01	Halo , white with 1-3/8" diameter round collar
	APB-6	11143-02	Halo , black with 1-3/8" diameter round collar (shown above)
	APB-6B	11144-02	Halo , black with 1-3/8" diameter square collar
	APB-6C	11144-01	Halo , white with 1-3/8" diameter square collar, same style as APB-6B
2	APB-3	10431-01	Clear Cap , round, for 7/8" diameter button
3	APB-2	11133-	Button Insert , 7/8" diameter round white button with black character, specify marking, i.e. APB-2-ARROW . Special markings available.
	APB-2/2A-SPACER	11899-01	Spacer , for pushbutton, meets California code requirements
4	APB-7	10419-01	Cam , contact actuator for 7/8" round button
5	APB-4B	12058-01	Retainer , yoke
6	APB-4A	10826-01	Yoke , for pushbutton assembly
7	APB-4C	12060-01	Screw , terminal
8	APB-9	11864-01	Contact , movable with silver pad
9	APB-8	12061-01	Screw , contact
10	ML-6	10947-01	Lamp , 120V, 120MB
11	APB-12	11811-01	Holder , lamp socket
12	APB-12A	10837-01	Shunt strip

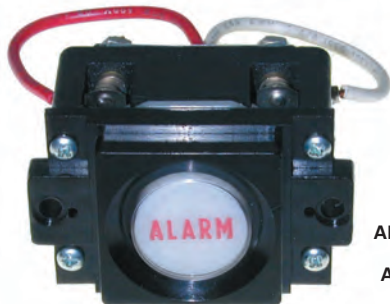

APB-1-ALARM
with
APB-6B Halo

■ Available as special order with alternate halos

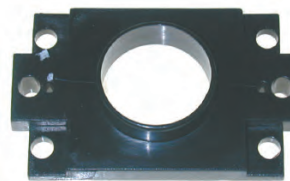

APB-4



APB-5

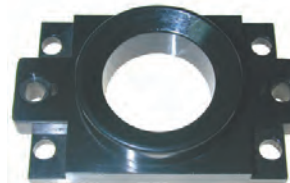

APB-6

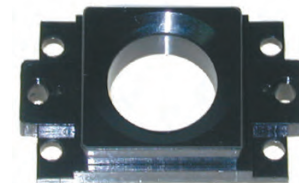

APB-6B

Car Signal Components

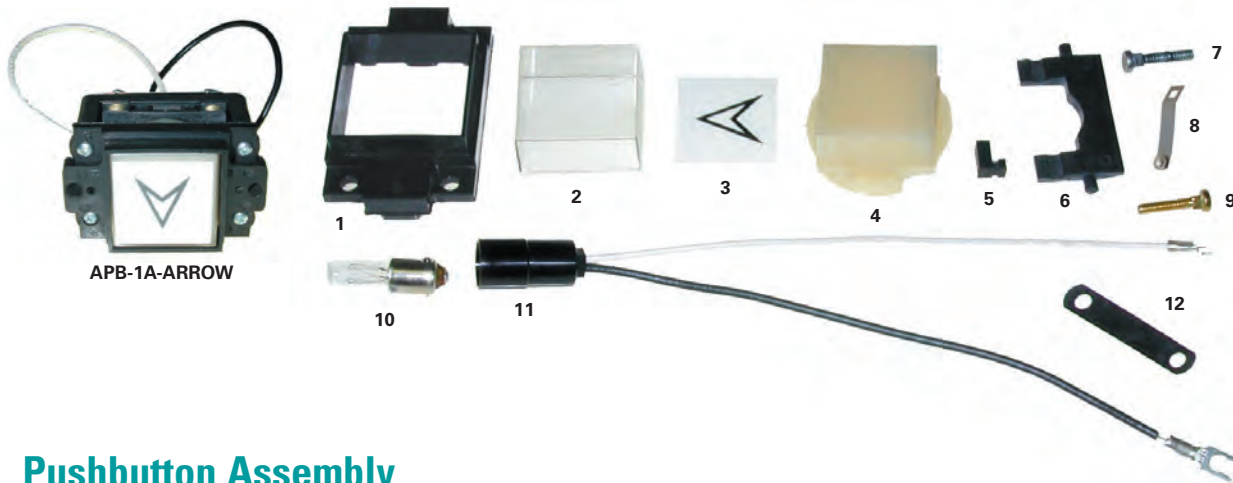

Pushbutton Assembly

Item	S.E.E.S. #	O.E.M. #	Description
1-12	APB-1A-	PB-46	Pushbutton assembly complete , assembled with components shown using standard black collar APB-5A and square clear cap APB-3A with square button insert marked with arrow APB-1A-ARROW and contact actuator cam for square buttons APB-7A. Specify marking i.e. APB-1A-ARROW
1	APB-5A	11147-02	Collar , 1-3/8" square black, for 1-1/4" square button
1	APB-6A	11147-01	Collar , 1-3/8" square white, for 1-1/4" square button
2	APB-3A	10432-01	Clear Cap , square for 1-1/4" square button
3	APB-2A-	11135-	Button Insert , white, 1-1/8" square, specify marking, i.e. APB-2A-ARROW
4	APB-7A	10416-01	Cam , contact actuator for 1-1/4" square button
5	APB-4B	12058-01	Retainer , yoke
6	APB-4A	10826-01	Yoke , for pushbutton assembly
7	APB-4C	12060-01	Screw , terminal
8	APB-9	11864-01	Contact , movable with silver pad
9	APB-8	12061-01	Screw , contact
10	ML-6	10947-01	Lamp , 120V, 120MB
11	APB-12	11811-01	Holder , lamp socket
12	APB-12A	10837-01	Shunt strip

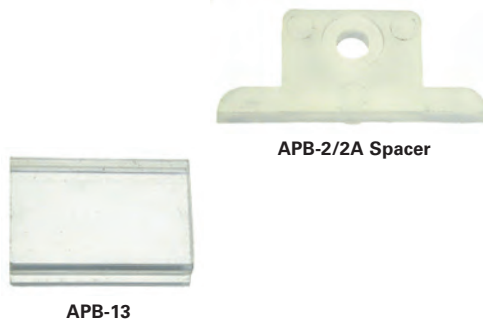

S.E.E.S. #	O.E.M. #	Description
APB-2/2A-SPACER	11899-01	Spacer for pushbutton, meets California code
APB-13	10839-01	Lens for dial-o-matic

Car Signal Components

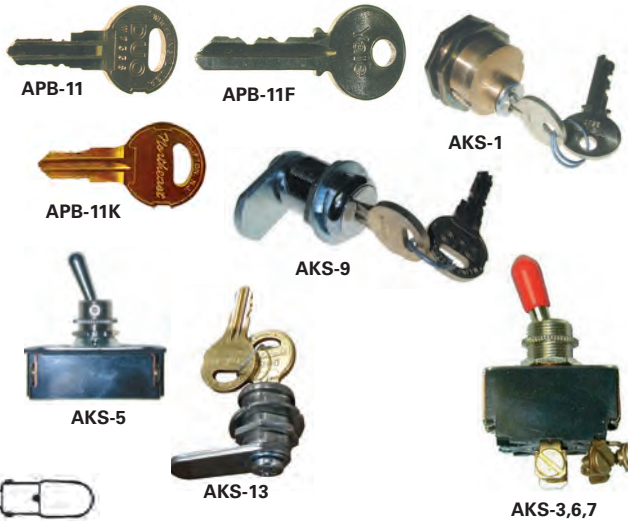

1. T3-1/4 Mini Bayonet
2. S-6 Double Contact Bayonet
3. G 4-1/2 Mini Bayonet
4. S-6 Double Candelabra Screw
5. G-6 Double Contact Bayonet
6. T4-1/2 Candelabra Screw
7. T2-1/2 Mini Bayonet
8. T-8 Candelabra Screw
9. S-8 Single Contact Bayonet

Lamps

Fig.	S.E.E.S. #	O.E.M. #	Description
1	ML-10	10941-01	44, 6.3V
1	ML-68	10927-01	313, 28V
1	ML-132	12555-01	1810, 6V
1	ML-133	13284-01	1813, 14.4V
1	ML-130	12362-01	1828, 37.5V
1	ML-47	10931-01	1829, 28V
1	ML-92	10932-01	1835, 55V
1	ML-12	10933-01	1893, 14V
1	ML-109	12326-01	238, 6V
2	ML-26	10945-01	6S6DC, 30V
2	ML-66	10938-01	6S6DC, 60V
2	ML-78	10948-01	6S6DC, 25V
2	ML-19	10949-01	6S6DC, 145V
2	ML-20R	10950-01	10S6DC, 250V
3	ML-31	10946-01	503, 5.1V
3	ML-134	13283-01	55, 7V
4	ML-39	13054-01	6S6, 30V
4	ML-17	10939-01	6S6, 155V
4	ML-46	13053-01	10S6, 230
5	ML-135	10942-01	68, 13.5V
5	ML-81	10941-01	90, 13V
6	ML-52	13201-01	T4-1/2, 130V
6	ML-67A	13202-01	T4-1/2, 250V
7	ML-6	10947-01	120MB, 120V
8	ML-90	13283-01	25T8, 120V
9	ML-94	12556-01	88, 6.8V

Lamp Sockets

S.E.E.S. #	O.E.M. #	Description
APB-12	11822-01	MB base , for pushbutton
APB-14	12347-01	DC bayonet base , for position indicator
APB-15	11817-01	MB base , for position indicator

Lock Cylinders and Keys

S.E.E.S. #	O.E.M. #	Description
APB-11	10917-01	Key , Duo W7336
APB-11A	10911-01	Key , Duo J200
APB-11B	10913-01	Key , Duo H7005
APB-11C	10914-01	Key , Duo K7048
APB-11D	10915-01	Key , Duo K7049
APB-11E	10916-01	Key , Duo W7320
APB-11F	12273-01	Key , Yale 3500
APB-11G	12274-01	Key , Yale 3501
APB-11H	12275-01	Key , Yale 3502
APB-11J	W7049	Key , Duo W7049
APB-11K	J208	Key , J208
AKS-8	11113-01	Lock Cylinder , Duo key W7320
AKS-9	11115-01	Lock Cylinder , Duo key W7336
AKS-10	11121-01	Lock Cylinder , Duo key W7048
AKS-11	11123-01	Lock Cylinder , Duo key W7049
AKS-12	11112-01	Lock Cylinder , Duo key H7005
AKS-13		Lock Cylinder , Duo, J200 Key
AKS-14		Lock Cylinder , Duo, 2 Position, Remove 2, J200 Key
AKS-15		Key Switch , 2 Pos, Rem 2, Independent Service, J200 Key

Toggle Switches

S.E.E.S. #	O.E.M. #	Description
AKS-1	B749015-A	Key Switch , cylinder only, 3 position, removable in one position only. Pull, with 3500 key, 1-1/8" diameter.
AKS-3	11838-01	Switch , 3PST, toggle style with red bat for emergency stop switch
AKS-5	11834-01	Switch , toggle style DPST
AKS-6	11835-01	Switch , toggle style DPDT
AKS-7	11836-01	Switch , toggle style DP, 3 position, spring return to center position

Gongs

S.E.E.S.#	O.E.M. #	Description
MIS-125	10875-01, A32024A, 9001-61	115 VAC
MIS-125A	10876-01, A32024B, 9001-63	40 Watt Series
MIS-125B	10877-01, A32024C, 9001-62	25 Watt Series

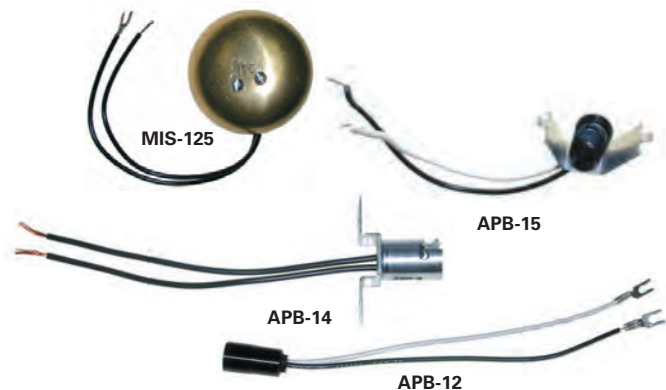

Brushes

S.E.E.S. #	O.E.M. #	Description
ACB-1	10367-02	G.E. MG Set & Hoist motor 3/8" x 1" x 2", grade T563
ACB-1A	10367-01	G.E. MG Set & Hoist motor 3/8" x 1" x 2", grade B253
ACB-1B	10364-01	G.E. MG Set & Hoist motor 3/8" x 1-1/4" x 2", grade T563
ACB-1C	10364-02	G.E. MG Set & Hoist motor 3/8" x 1-1/4" x 2", grade B253
ACB-1D	10373-01	Bull MG Set & Hoist motor 3/8" x 1-1/4" x 2", grade SA45
ACB-1E	10373-02	Bull MG Set & Hoist motor 3/8" x 1-1/4" x 2", grade B253
ACB-2	13155-02	G.E. MG Set & Hoist motor 1/2" x 1" x 2", grade B253
ACB-2A	13126-01	G.E. MG Set & Hoist motor 1/2" x 1" x 2", grade SA45
ACB-2B	13155-01	G.E. MG Set & Hoist motor 1/2" x 1" x 2", grade T563
ACB-3	10371-01	Bull MG Set & Hoist motor 1/2" x 1-1/4" x 1-5/8", grade SA45
ACB-4	10372-01	Bull MG Set & Hoist motor 5/16" x 1" x 1-13/16", grade SA45
ACB-5	10374-01	Bull MG Set & Hoist motor 1/2" x 1-1/4" x 2", grade SA45
ACB-6	12531-01	G.E. MG Set & Hoist motor 5/8" x 1-1/4" x 2-1/8", grade B253/561
ACB-7	13417-01	G.E. MG Set & Hoist motor 1/2" x 1-1/4" x 2-1/2", grade SA45
ACB-8	12568-01	G.E. MG Set & Hoist motor 3/8" x 1" x 1-3/16", grade B253
ACB-8A	12568-02	G.E. MG Set & Hoist motor 3/8" x 1" x 1-3/16", grade T563
ACB-9	12554-01	G.E. MG Set & Hoist motor 5/8" x 1-1/2" x 2-1/2", grade B253
ACB-10	13203-01	G.E. MG Set & Hoist motor 5/8" x 1-1/4" x 2-1/8", grade B253
ACB-10A	13203-02	G.E. MG Set & Hoist motor 5/8" x 1-1/4" x 2-1/8", grade T563
ACB-11	12567-02	G.E. MG Set & Hoist motor 3/8" x 3/4" x 1-1/4", grade T563
ACB-11A	12567-02	G.E. MG Set & Hoist motor 3/8" x 3/4" x 1-1/4", grade B253
ACB-12	12358-01	5/16" x 1-1/4" x 2"

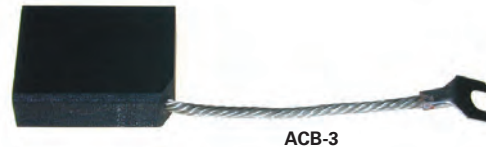

Coils

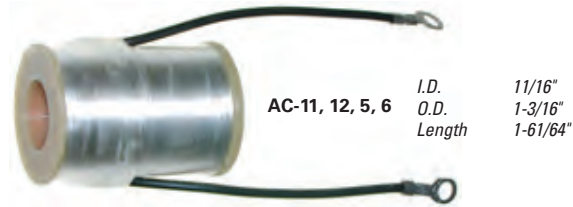

DC Coils for #1 Relay Stepper and Contactor

S.E.E.S. #	O.E.M. #					Description
AC-3	10473-01,	140-6006-05,	LA124,	AR7240,	0158-0005	240 Volts, 7,240 Ohms
AC-4	10474-01,	140-6006-04,	LA226,	AR4840,	0158-0006	270 Volts, 4,840 Ohms
AC-7	10477-01,	140-6006-03,	LA-462,	AR324,	0158-0010	80 Volts, 231 Ohms
AC-8	10478-01,	140-6006-01,	LA411,	AR-14,	0158-0011	7 Volts, 14 Ohms
AC-19	10613-01,	140-6006-02,		AR-100,		26 Volts, 100 Ohms

S.E.E.S. #	O.E.M. #					Description
AC-5	10475-01,	140-6006-08,	LA219,	AR450,	0158-0007	60 Volts, 450 Ohms
AC-6	10476-01,	140-6006-09,	LA100,	AR2000,	0158-0008	110 Volts, 2,000 Ohms
AC-11	10612-01,	140-6006-06,	LA1409,	AR1200,	0158-0040	110 Volts, 1,150 Ohms
AC-12	10501-01,	140-6006-07,		AR683,	0158-0041	110 Volts, 835 Ohms



DC Coils for #2 Relay

S.E.E.S. #	O.E.M. #					Description
AC-10	10480-01,	140-6003-03,	LA1331,	0158-0013,		140 Volts, 3,340 Ohms
AC-14	12076-01,	140-6003-01,	LA1401,	0158-0025,		110 Volts, 1,725 Ohms
AC-15	12076-02,	140-6003-02,	LA1402,	0158-0026,		55 Volts, 430 Ohms

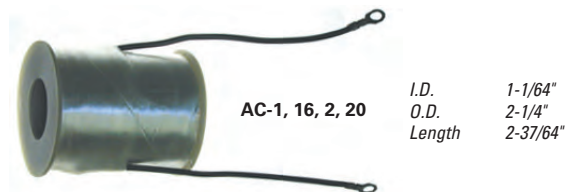

DC Coils for #3A, 5A Relays Contactor and Series Field Switch

S.E.E.S. #	O.E.M. #					Description
AC-1	10470-01,	140-6011-01,	LA201,	MC1000,	0158-0002	270 Volts, 1,000 Ohms
AC-2	10471-01,	140-600-03,	CLN2,		0158-0003	80 Volts, 218 Ohms
AC-16	10472-01,	140-6011-02,	LA127,	MC2500,	0158-0004	240 Volts, 2,500 Ohms
AC-20	13036-01,	140-6011-04,	140-0585-01,			110 Volts, 460 Ohms

Coils

Coils for #2 and #3 Machine, 11" and 13" Brake

S.E.E.S. #	O.E.M. #	Description
AC-21	10506-01, 140-0018-01, 139-0005-01, 0158-0055	270 Volts, 680 Ohms 2-5/32" I.D., 4-3/4" O.D., 6-5/8" L
AC-22	0508-01, 140-0018-02, 0158-0058	120 Volts, 170 Ohms 2-5/32" I.D., 4-3/4" O.D., 6-5/8" L

Coils for #4 Machine, 14" Brake

S.E.E.S. #	O.E.M. #	Description
AC-23	10483-01, 140-0019-01, LA387, 0156-0016, 10507-01, 140-0019-03, 0158-0057	240 Volts, 375 Ohm 2-1/2" O.D., 5-1/4" I.D., 7-1/2" L

Coils for #5 and #7 Machine, 18" Brake

S.E.E.S. #	O.E.M. #	Description
AC-26	13117-01, 140-0020-03, 0158-0061	120 Volts, 52 Ohms 3-9/16" O.D., 6-1/8" I.D., 9-1/4" L

S.E.E.S. #	O.E.M. #	Description
AC-9	10479-01, LA890 140-6002-01	Coil for Dial-O-Matic Position Indicator 30/55 VDC, 371 ohms 13/64" x 21/64" I.D., 3/4" x 7/8" O.D., 7/8" L
AC-17	12077-01, 140-6021-01	DC Coil for #2A Relay, 110 VDC, 1500 Ohms, 1-3/4" O.D., 39/64" I.D., 31/32" L
AC-17A	10576-01-140-6001-03	DC Coil for #2A Relay, 140 VDC, 1-3/4" O.D., 39/64" I.D., 31/32" L
AC-18	12077-02, 140-6021-02	DC Coil for #2A Relay, 55 VDC, 375 Ohms, 1-3/4" O.D., 39/64" I.D., 31/32" L
AC-29	10574-01, 140-6001-01	Coil for Reverse Phase Relay, 208/220 VAC, 1-1/2" O.D., 5/8" I.D., 1" L
AC-30	10576-01-140-6001-03	Coil for Reverse Phase Relay, 80/85 VAC, 1-1/8" O.D., 5/8" I.D., 1" L
AC-28	10604-01	Coil for Stahl Contactors 6573/2 & 6574/2, 110 VDC, 5/8" I.D., 1-3/4" O.D., 2-5/8" L
AC-31	10504-01, 0158-0046 140-6013-6	DC Solenoid Coil for Design Unit Valve, 270 VDC, 11/16" I.D., 1-7/8" O.D., 2-3/8" L
AC-32	10503-01, 0158-0048 140-6013-6	DC Solenoid Coil for Design Unit Valve, 110 VDC, 11/16" I.D., 1-7/8" O.D., 2-3/8" L



AC-21



AC-26



AC-9



AC-29



AC-31

Door Parts and Equipment



ADO-7



ADO-7A

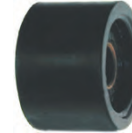

ADO-7B



ADO-7C



ADO-7D



ADO-7E



ADO-12



ADO-12A



ADO-12B



ADO-12C



ADO-4



ADO-4A



ADO-16



ADO-19



ADO-20



ADO-22



ADO-23



ADO-21



ADO-29

S.E.E.S. #	O.E.M. #	Description
ADO-7	11921-01, A466022	Roller Assembly , 1-1/4" O.D. with 2-3/4" long shaft, for lever
ADO-7A	11921-02, A466022	Roller Assembly , 1-1/4" O.D. with 4" long shaft, for lever
ADO-7B	11912-01, B466005	Roller , 1-1/4" O.D., used on ADO-7 & ADO-7A
ADO-7C	12161-01, A466026	Roller Assembly , 1-1/4" O.D. with 1-7/8" L threaded shaft, for gate switch
ADO-7D	12161-02, A466026	Roller Assembly , 1-1/4" O.D. with 3-1/32" L threaded shaft, for gate switch
ADO-7E	12005-01	E-Clip for 3/8" shaft diameter
ADO-12	11971-01, A776005	Eccentric Upthrust Roller , steel 1-1/6" O.D. for #4 hatch door hanger
ADO-12A	11972-01, A776010	Eccentric Upthrust Roller , steel 1-1/2" O.D.
ADO-12B	13240-01	Eccentric Upthrust Roller , steel 15/16" diameter
ADO-12C	12576-01	Eccentric Upthrust Roller , steel 1-3/4" diameter (concave)

Armor #1 Interlock Replacement Parts

S.E.E.S. #	O.E.M. #	Description
ADO-4	11905-01, B326005	Hook Assembly with replaceable contact nose
ADO-4A		Contact Nose , "exclusively" for S.E.E.S. ADO-4 Hook
ADO-4B		Door Latch Kick Off Spring

S.E.E.S. #	O.E.M. #	Description
ADO-15	12680-01, A749007	Switch Base Assembly L.H.
ADO-16	12679-01, A749019	Switch Base Assembly R.H.
ADO-17	10210-01, B021025	Base only, R.H.
ADO-18	11995-01, B021026	Base only, L.H.
ADO-19	11181-01, A164045	Contact , stationary
ADO-20	11150-01, A164004	Contact , movable
ADO-21	11997-01, A521002	Shunt , metal
ADO-22	11996-01, A509042	Spring
ADO-23	12102-01, A520006	Seat
ADO-29	10297-01, B042055	Bracket , R.H. for #1 Interlock
ADO-30	10298-0, B042056	Bracket , L.H. for #1 Interlock

Door Parts and Equipment



#1 Interlock Parts

S.E.E.S. #	O.E.M. #	Description
ADO-26	11965-01, B787003	Lever Assembly, R.H.
ADO-26A	11966-01, B787004	Lever Assembly, L.H.

S.E.E.S. #	O.E.M. #	Description
ADO-2	10088-01, A080012	Arm and Roller, pick up lever, R.H.
ADO-3	10091-01, A080015	Arm and Roller, pick up lever, L.H.
ADO-6	11909-01, A343018	Link for #1 Interlock
ADO-26B	11907-01, B339023	Lever
ADO-26C		Bushing Set, .750 O.D., .377 I.D.
ADO-26C-1		Bushing Set, .625 O.D., .260 I.D.
ADO-26D	10221-01, B021058	Base only
ADO-34	11908-01, A343009	Link Assembly
ADO-35	10284-01, C030013	Bellcrank Assembly, upper
ADO-36	10285-01, C030014	Bellcrank Assembly, lower
ADO-37	10342-01, B144002	Cam, R.H., 9-1/4" long, 7/8" wide, (Inside: .725") for single speed doors
ADO-38	10343-01, B144003	Cam, L.H., 9-1/4" long, 7/8" wide (Inside: .725") for single speed doors
ADO-39	10346-01, B144014	Cam, R.H., 2" wide (Inside: 1.86") for two speed doors
ADO-40	10347-01, B144015	Cam, L.H., 2" wide (Inside: 1.86") for two speed doors
ADO-42	11977-01	Switch assembly for #6 safety edge
MIS-157	10333-01, V045008	Bumper, door jamb, 1" diameter with threaded 1/2" diameter shaft



Door Parts and Equipment

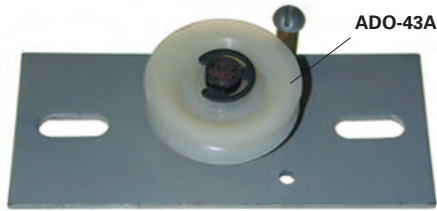

ADO-43

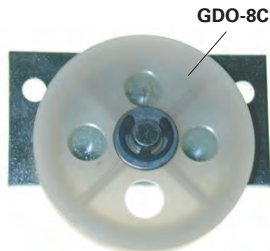

ADO-27A



ADO-25



AW-12



ADO-33



ADO-31



ADO-24

#6 Safety Edge Parts

S.E.E.S. #	O.E.M. #	Description
ADO-43	13445-01, A742048	Deflector assembly for safety edge cable
ADO-43A	12159-01, V466024	Sheave , 1-5/8" for ADO-43 deflector assembly
AW-12	11928-01	Roller , 2-7/16" O.D., bearing .3937" I.D. nylon roller for relating cable
ADO-27A	13631-01, A776011	Sheave assembly for relating cable, wheel 2-3/4", base 3-3/8" x 1-3/4"

Cables

S.E.E.S. #	O.E.M. #	Description
ADO-33	12501-01, A343025	Relating Cable Kit , 8' long for two speed doors
ADO-33A	12501-02, A343025	Relating Cable Kit , 17' long for center opening doors
ADO-41	10341-02	Cable with hitch , 8' cable length

S.E.E.S. #	O.E.M. #	Description
ADO-24	10922-01, B327015	Emergency door key
ADO-25	13351-01	Belt , Door operator, 39"
ADO-31	11938-01	Interlock Jumper
MIS-124	10642-01, ML1703, V783001	Spirator , door closer reel
MIS-124-ST		Spirator , 6" SmarTork door closer up to 20% more tension
MIS-124-ST-BK		Bracket , for Smar-Tork Door Closer
MIS-124E		Spirator , 5" O.D., Heavy Duty reel closer with combo hub
MIS-160		Bracket , with square shank for MIS-124 Spirator



MIS-124

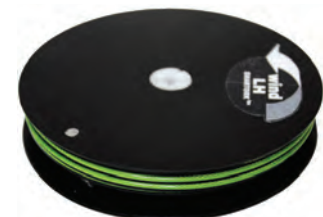

MIS-124-ST

Door Parts and Equipment



ADO-8



ADO-1A



ADO-11A



ADO-9



ADO-10



ADO-11

S.E.E.S. #	O.E.M. #	Description
ADO-1A	10349-01, B144001	Cam for #3 and #4 Door Operator
ADO-8	11177-01, A164035	Contact, movable
ADO-9	12610-01, A509018	Spring
ADO-10	11178-01	Contact, stationary normally open, stud
ADO-11	11176-01	Contact, stationary normally closed, flat
ADO-11A	11856-01, B144018	Switch Assembly for #3 and #4 Door Operator
ADO-28	10101-01	Arm and Roller Assembly with link for door clutch
ADO-32	10350-01, B0149-0011A, C149001/C149011	Catch for #1 Clutch
ADO-32A		Catch, for #1 clutch
ADO-44	10691-01, B254006	Gib, insert, 6" for 15 lb. rail
ADO-44A		Guide Shoe Insert, 6" L for 3/8" Rail



ADO-28



ADO-32A

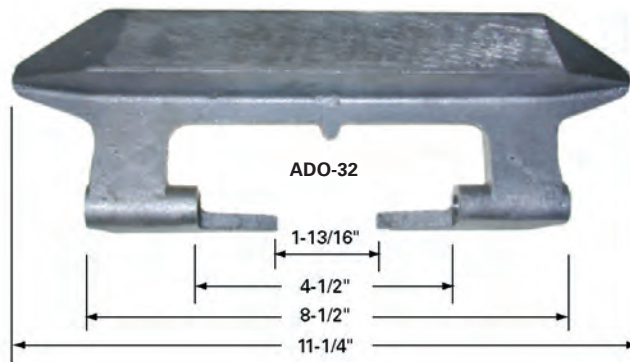

ADO-44



ADO-44A

Printed Circuit Boards and Timers

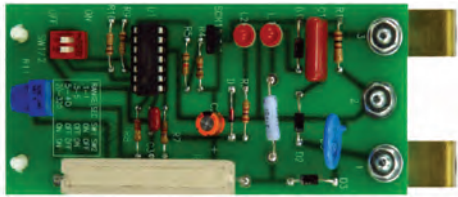

APC-1

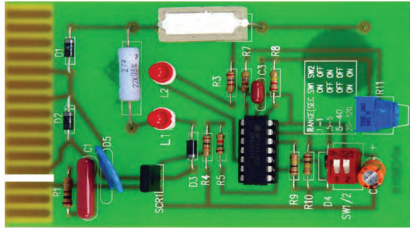

APC-8

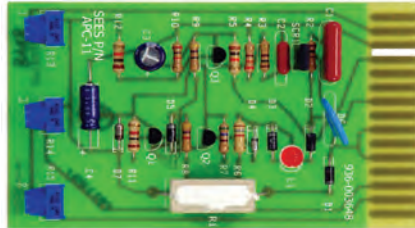

APC-11



APC-15



APC-18



ACAP-1A

S.E.E.S. #	O.E.M. #	Description
APC-1	12581-01, C058-8261-01, ML42318-2S-250V, 12582-01, C058-8261-02, ML42318-6S-250V	Timer module , .1-5 second range, stud mount timer, 250 VDC
APC-4	12589-01, C058-8261-04, ML42318-2S-110V 12590-01, C058-8261-05, ML42318-6S-110V	Timer module , .5-5 second range, stud mount timer, 110 VDC
APC-8	12583-01, ML42343-2A, C058-8262-01 12584-01, C058-8262-02, 12585-01, ML42343-15A, C058-8262-03, ML42343-60A, 12586-01, C058-8262-04, ML42343-180A	Timer module , .1-180 sec., 110 VDC one potentiometer, plug in style
APC-8A		PCB Socket , 15 Pin with solder eyelets, APC-8,11,12, APV-15,1
APC-11	12587-01, C058-8263-01, ML42338-15A, ML42361-15A	Timer module , 1-10 second timing range, 110 VDC three potentiometer, plug in style. NOTE: Replaces two potentiometer timer
APC-12	12588-01, C058-8263-02, ML42338-60A, ML42361-60A	Timer module , 5-50 second timing range, 110 VDC three potentiometer plug in style. NOTE: Replaces two potentiometer timer.

S.E.E.S. #	O.E.M. #	Description
APC-15	10326-01, C058-8369-01 ML34779G1	Zone Call Counter printed circuit board
APC-18	14240-01	P.C. Board , power touch button 24V

Capacitors

S.E.E.S. #	O.E.M. #	Description
ACAP-1A	11047-01	50 MFD 150 VDC
ACAP-2	11025-01	100 MFD 150 VDC
ACAP-3	11026-01	300 MFD 150 VDC
ACAP-4	11027-01	900 MFD 150 VDC
ACAP-5	11053-01	40 MFD 350-450 VDC
ACAP-6	11028-01	95 MFD 350 VDC
ACAP-1	11032-01	225 MFD 350 VDC
ACAP-7	11033-01	275 MFD 350 VDC
ACAP-8	11034-01	650 MFD 350 VDC
ACAP-9	11035-01	1K MFD 350 VDC
ACAP-10	11040-01	10 MFD 450 VDC
ACAP-11	11041-01	20 MFD 450 VDC
ACAP-12	11043-01	225 MFD 450 VDC
ACAP-13	11831-01	.1 MFD 600 VDC

Rectifiers

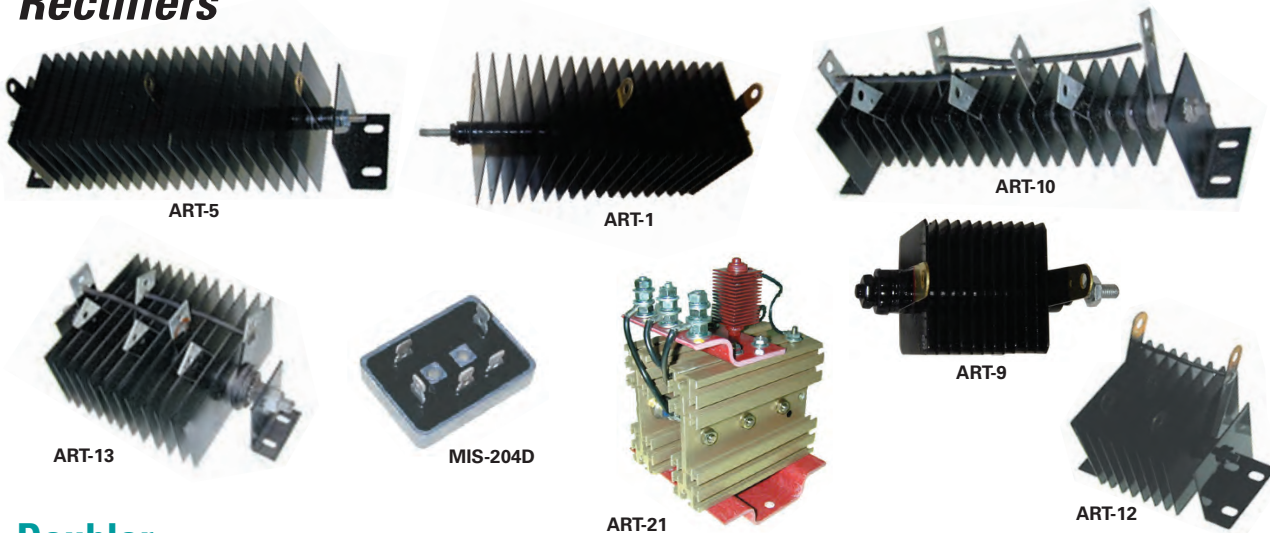

Doubler

S.E.E.S. #	O.E.M. #	Description	Max In	Max Out
ART-11	11279-01, C133S10D1H11G	20 plates 4 x 5	260 VAC	290 VDC, 2.6 Amp
ART-5	11282-01, C44S10D1H11G	20 plates 2.6 x 2.6	260 VAC	290 VDC, 10.0 Amp
ART-14	C25S10DD1H11G	20 plates 2 x 2	260 VAC	290 VDC, 6.0 Amp
ART-6	11281-01, C16S10D1H11G	20 plates 1.6 x 1.6	260 VAC	290 VDC, 3.5 Amp
ART-3	C6S10D1H12G	20 plates 1 x 1	260 VAC	290 VDC, 1.2 Amp
ART-1	11298-01, C44S9D1S12G	18 plates 2.6 x 2.6	230 VAC	265 VDC, 10.0 Amp
ART-2	C16S9D1S12G	18 plates 1.6 x 1.6	234 VAC	265 VDC, 3.5 Amp
ART-7	11296-01, C6S9D1S12G	18 plates 1 x 1	234 VAC	265 VDC, 1.2 Amp
ART-4	11285-01, C44S4BA1H11G	3 PHASE 24 plates 2.6 x 2.6	104 VAC	119 VDC, 3.5 Amp
ART-8	11280-01, C16S4BA1H11G	3 PHASE 24 plates 1.6 x 1.6	104 VAC	119 VDC, 3.5 Amp
ART-10	C11S3BA1H11G	3 PHASE 18 plates 2.6 x 2.6	78 VAC	89 VDC, 2.6 Amp
ART-13	11283-01, C44S2BA1H11G	3 PHASE 12 plates 2.6 x 2.6	52 VAC	68 VDC, 10.0 Amp
MIS-204D	11274-01, VTH400, 11295-01, 11659-01, VTH600, VTH200	3 PHASE	600 VAC	480 VDC, 27.5 Amp
ART-21	11292-01, SS-0623-AP	3 PHASE, Silicon	800 VAC	560 VDC, 54 Amp
ART-9	11288-01, C16-9919	12 plates 1.6 x 1.6	312 VAC	130 VDC, 1.2 Amp
ART-15	11286-01, C11S3B1H11G	12 plates 1.3 x 1.3	78 VAC	63 VDC, 1.7 Amp
ART-20	11300-01, C6N10H1E11R	10 plates 1 x 1	399 VAC	250 VDC, .30 Amp
ART-12	11287-01, C44S3B1H11G	8 plates 2.6 x 2.6	78 VAC	63 VDC, 7.2 Amp
ART-19	11284-01, C44S2H1S1G	2 plates 2.6 x 2.6	52 VAC	32 VDC, 3.3 Amp
ART-16	11290-01, C6S2H1E1G	2 plates 1 x 1	52 VAC	22 VDC, 0.8 Amp
ART-17	11276-01	6 plates 1 x 1	160 VAC	100 VDC, .30Amp
ART-18	11277-01	6 plates 1.6 x 1.6	180 VAC	112 VDC, 1.1Amp

Resistors

S.E.E.S. #	O.E.M. #	Description	S.E.E.S. #	O.E.M. #	Description
RES-50	11616-01	1 Ohm	RES-56	11629-01	100 Ohm
RES-51	11617-01	2 Ohm	RES-57	11631-01	150 Ohm
RES-51B	11619-01	4 Ohm	RES-59	11632-01	250 Ohm
RES-52	11620-01	5 Ohm	RES-59A	11633-01	300 Ohm
RES-53	11621-01	10 Ohm	RES-60	11634-01	500 Ohm
RES-53A	11623-01	15 Ohm	RES-61	11635-01	1K Ohm
RES-53B	11624-01	20 Ohm	RES-61A	11637-01	2K Ohm
RES-54	11625-01	25 Ohm	RES-62	11638-01	2.5K Ohm
RES-55	11626-01	50 Ohm	RES-63	11640-01	5K Ohm
RES-55A	11628-01	75 Ohm	RES-64	11641-01	10K Ohm



200 Watt Adjustable 10-1/2" long.

Relay Parts

No. 1 Stepping Relay

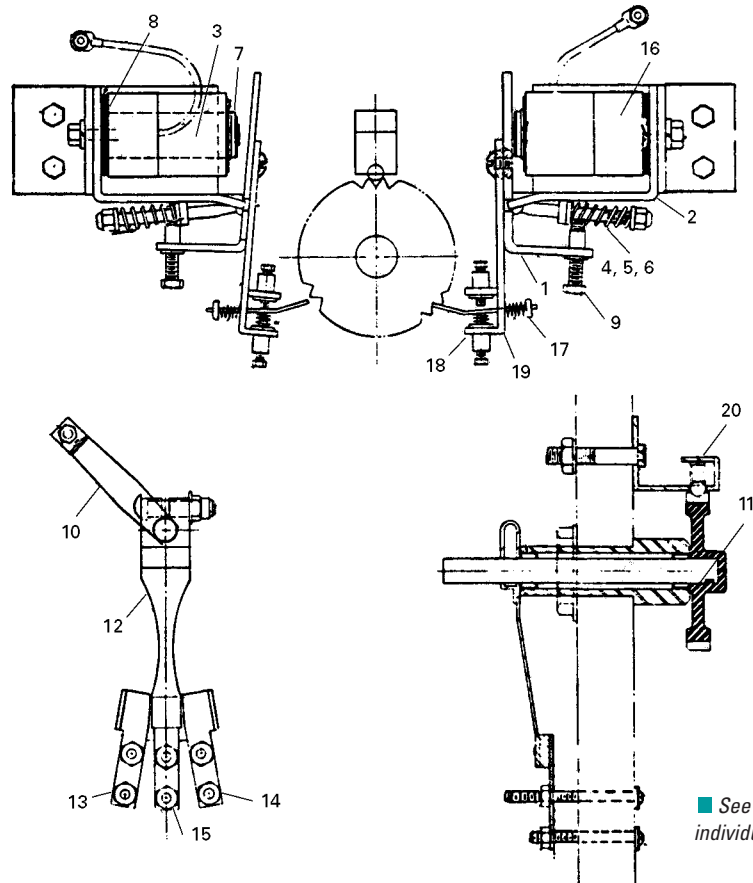

■ See page 521 for individual components.

Item	S.E.E.S. #	O.E.M. #	Description
1	ARP-40	10119-01, A006001	Armature
2	ARP-41	10656-01, B234001	Frame
3	ARP-42	10616-01, A165001	Magnet Core
4	ARP-17D	10355-01, A050001	T-Bolt, 10-24 x 2"
5	ARP-16A	10637-01, A171004	Cup Washer
6	ARP-14A	10748-01, A509033	Compression Spring
7	ARP-40B	10739-01, V468005	Retaining ring
8	ARP-40C	10827-01, V646001	Retaining washer
9	ARP-55	10338-01	Nylon bushing
10	AS-11	10357-01, A767001	Brush assembly
11	AS-1	10661-01, B252003	Gear with shaft
12	AS-5	10069-01, B008034	Movable contact brush assembly
13	AS-10	11171-01, A164029	Stationary contact R.H.
14	AS-9	11172-01, A164030	Stationary contact L.H.
15	AS-8	11173-01, A164031	Stationary contact, intermediate
16	AC-7	10477-01	Coil
17	ARP-16	10636-01, A171003	Cup Washer
18	AS-7	10712-01, A405002	Stepper pawl
19	AS-6	10137-01, B008026	Pawl assembly arm
20	AS-4	10662-01, B286028	Housing, with ball and spring

Relay Parts

No. 1 Relay

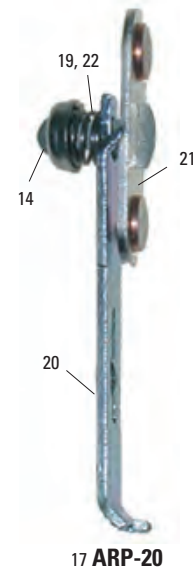
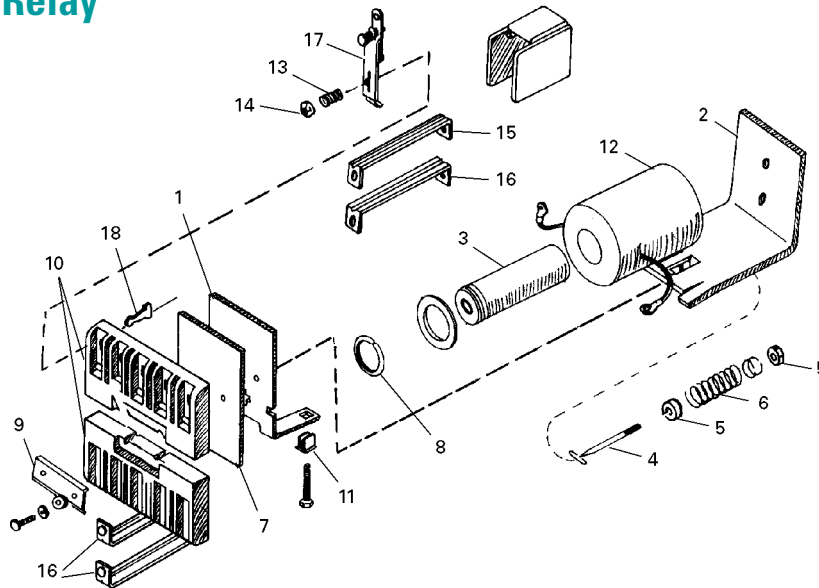

ARMOR

Item	S.E.E.S. #	O.E.M. #	Description
1	ARP-40	10119-01, A006001	Armature
2	ARP-41	10656-01, B234001	Frame
3	ARP-42	10616-01, A165001	Core, Magnet, standard
	ARP-59	10620-01, A165006, 516178	Core, Magnet, Timing with non-magnetic separator
4	ARP-17D	10355-01, A050001	Tee bolt, 10-24 x 2"
5	ARP-16A	10637-01, A171004	Cup washer
6	ARP-14A	10748-01, A509033	Compression spring
7	ARP-40A	10633-01, A304006	Armature insulator
8	ARP-40B	10739-01, V468005	Retaining ring
9	ARP-46	10429-01, A153002	Clamp for contact holder
10	ARP-43	10694-04, A283011, 304-006-1	Holder, (3) contact
	ARP-44	10694-03, A283012, 304-007-1	Holder, (4) contact
	ARP-45	10694-02, A283013, 304-008-1	Holder, (5) contact
11	ARP-55	10338-01	Bushing
12	AC-8	10478-01	Coil, 7 VDC (AR14; 0158-0011; B140-6006-01; LA-411)
	AC-19	10613-01	Coil, 26 VDC (AR100; B140-6006-02)
	AC-7	10477-01	Coil, 80 VDC (AR324; 0158-0010; B140-6006-03; LA-462)
	AC-4	10474-01	Coil, 270 VDC (AR4840; 0158-0006; B140-6006-04; LA-226)
	AC-3	10473-01	Coil, 270 VDC (AR7240; 0158-0005; B140-6006-05; LA-124)
	AC-11	10612-01	Coil, 110 VDC (AR1200; 0158-0040; B140-6006-06; LA-1409)
	AC-12	10501-01	Coil, 110 VDC (0158-0041; B140-6006-07)
	AC-5	10475-01	Coil, 60 VDC (AR450; 0158-0007; B140-6006-08; LA-219)
	AC-6	10476-01	Coil, 110 VDC (AR2000; 0158-0008; B140-6006-09; CA-100)
13	ARP-12	10747-01, A509032	Compression Spring for movable contact assembly
14	ARP-16	10636-01, A171003	Cup washer, 5/16" diameter, for movable contact assembly
15	ARP-24	11159-01, A164014, 756-007-1	Stationary contact, N.C. 2-1/4" L
16	ARP-25	11160-01, A164015, 756-008-1	Stationary contact, N.O. 2-13/32" L
17	ARP-20	10442-01, A150-8001-01	Movable contact assembly (includes items 18-22)
18	ARP-17B	10028-01, A-007-0001-01	Contact anchor, 13/16" for movable contact assembly
19	ARP-17	10029-01, A002-003, 801-102-1	Tee bridge, contact anchor
20	ARP-18	10753-01, A288-004, 801-105-1	Contact, finger
21	ARP-19	11182-01, A164-046, 801-101-1	Contact bridge
22	ARP-12A	10745-01, A509096	Spring for ARP-20 contact assembly

Relay Parts

No. 1 Contactor

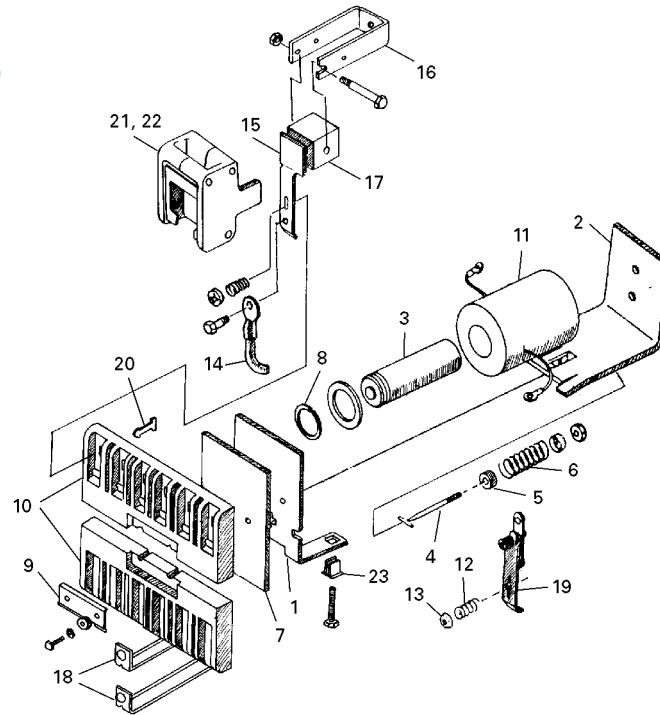

Item	S.E.E.S. #	O.E.M. #	Description
1	ARP-40	10119-01, A006001	Armature
2	ARP-41	10656-01, B234001	Frame
3	ARP-42	10616-01, A165001	Core, Magnet (standard)
4	ARP-17D	10355-01, A050001	Tee bolt, 10-24 x 2"
5	ARP-16A	10637-01, A171004	Cup washer
6	ARP-14A	10748-01, A509033	Compression spring
7	ARP-40A	10633-01, A304006	Armature insulator
8	ARP-40B	10739-01, V468005	Retaining ring
9	ARP-46	10429-01, A153002	Clamp for contact holder
10	ARP-43	10694-04, A283011, 304-006-1	Holder, (3) contact
	ARP-45	10694-02, A283013, 304-008-1	Holder, (5) contact
11	AC-8	10478-01	Coil, 7 VDC (AR14; 0158-0011; B140-6006-01; LA-411)
	AC-19	10613-01	Coil, 26 VDC (AR100; B140-6006-02)
	AC-7	10477-01	Coil, 80 VDC (AR324; 0158-0010; B140-6006-03; LA-462)
	AC-4	10474-01	Coil, 270 VDC (AR4840; 0158-0006; B140-6006-04; LA-226)
	AC-3	10473-01	Coil, 270 VDC (AR7240; 0158-0005; B140-6006-05; LA-124)
	AC-11	10612-01	Coil, 110 VDC (AR1200; 0158-0040; B140-6006-06; LA-1409)
	AC-12	10501-01	Coil, 110 VDC (0158-0041; B140-6006-07)
	AC-5	10475-01	Coil, 60 VDC (AR450; 0158-0007; B140-6006-08; LA-219)
	AC-6	10476-01	Coil, 110 VDC (AR2000; 0158-0008; B140-6006-09; CA-100)
12	ARP-12	10747-01, A509032	Compression Spring
13	ARP-16	10636-01, A171003	Cup washer, 5/16" diameter
14	ARP-10A	10743-01, A783-6361-01	Shunt lead (A521013)
15	ARP-6B	11164-01, A164021	Movable copper contact, 2-7/16"
16	ARP-6D	10697-01, A283010	Stationary contact holder, 2-3/8"
17	ARP-6C	11163-01, A164020	Stationary contact, N.O., Carbon
18	ARP-25	11160-01, A164015, 756-008-1	Stationary contact, N.O., 2-13/32" L
19	ARP-20	10442-01, A150-8001-01	Movable contact assembly
20	ARP-17B	10028-01, A-007-0001-01	Contact anchor, 13/16"
21	ARP-32C	10068-01	D.C. Arc barrier, with magnets, 2"
22	ARP-32D	10063-01, B725007	A.C. Arc barrier, with baffles, 2"
23	ARP-55	10338-01	Bushing

Relay Parts

No. 2 Relay

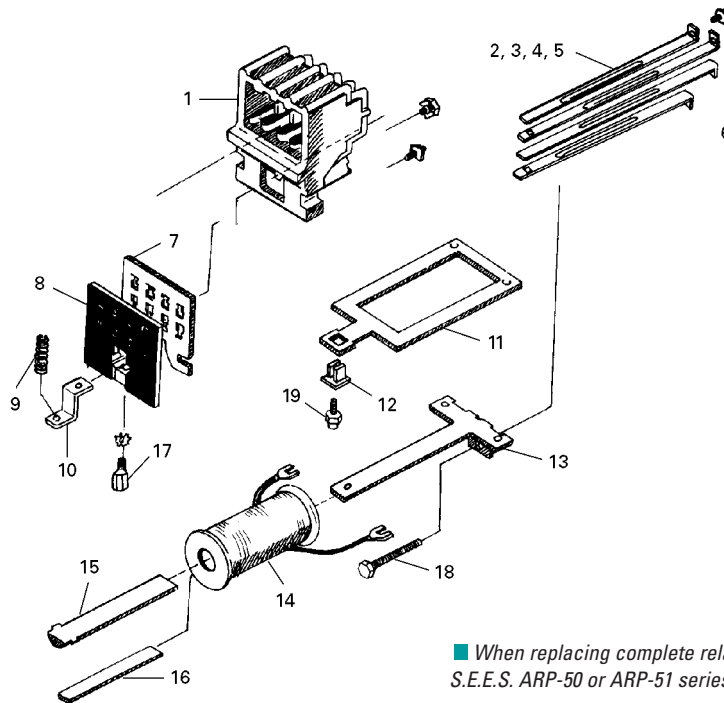

■ When replacing complete relay use Relay No. 2A, S.E.E.S. ARP-50 or ARP-51 series.

Item	S.E.E.S. #	O.E.M. #	Description
1	ARP-48	10192-01, B021005	Base
2	ARP-23A	11167-01, A164025	Movable short contact, 4-11/16" long
3	ARP-21	11165-01, A164023	Fixed short contact, 4-7/8" long
4	ARP-22	11166-01, A164024	Movable long contact, 5-1/16" long
5	ARP-23	11168-01, A164026	Fixed long contact, 5-1/4" long
6	ARP-48A	12063-01	Pan head screw, 6-32 x 5/16" cadmium plated with captive washer, N.O.
	ARP-48B	12064-01	Pan head screw, 6-32 x 5/16" brass plated with captive washer, N.C.
7	ARP-29-8&0	10744-09	Contact actuator, 8 N.O.
	ARP-29-0&8	10744-01	Contact actuator, 8 N.C.
	ARP-29-1&7	10744-02	Contact actuator, 1 N.O. - 7 N.C.
	ARP-29-2&6	10744-03	Contact actuator, 2 N.O. - 6 N.C.
	ARP-29-3&5	10744-04	Contact actuator, 3 N.O. - 5 N.C.
	ARP-29-4&4	10744-05	Contact actuator, 4 N.O. - 4 N.C.
	ARP-29-5&3	10744-06	Contact actuator, 5 N.O. - 3 N.C.
	ARP-29-6&2	10744-07	Contact actuator, 6 N.O. - 2 N.C.
	ARP-29-7&1	10744-08	Contact actuator, 7 N.O. - 1 N.C.
9	ARP-52	10750-01, A509047	Compression spring
10	ARP-53	10740-01, A454057	Spring retainer
11	ARP-54	10124-01, A006006	Armature
12	ARP-55	10338-01	Bushing
13	ARP-56	12078-01, A165003	Core
14	AC-10	10480-01	Coil, 140 VDC
	AC-14	12076-01	Coil, 110 VDC
	AC-15	12076-02	Coil, 55 VDC
15	ARP-57	10189-01, A018048	Core filler bar, 1/2 round
16	ARP-58	12074-01	Core filler spring, flat
17	ARP-55B		Threaded stud
18	ARP-56A		Screw, threaded hex head, 1-1/2" L
19	ARP-55A		Spring Seat

Relay Parts

No. 2A Relay

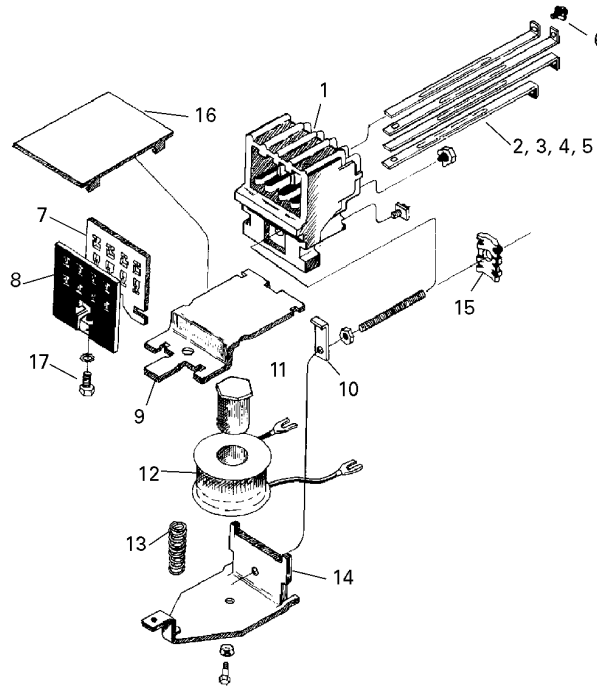

Item	S.E.E.S. #	O.E.M. #	Description
1	ARP-48	10192-01, B021005	Base
2	ARP-23A	11167-01, A164025	Movable short contact, 4-11/16" long
3	ARP-21	11165-01, A164023	Fixed short contact, 4-7/8" long
4	ARP-22	11166-01, A164024	Movable long contact, 5-1/16" long
5	ARP-23	11168-01, A164026	Fixed long contact, 5-1/4" long
6	ARP-48A	12063-01	Screw, 6-32 x 5/16", pan head, cadmium plated with captive washer
	ARP-48B	12064-01	Screw, 6-32 x 5/16", pan head, brass plated with captive washer
7	ARP-29-8&0	10744-09	Contact actuator, 8 N.O.
	ARP-29-0&8	10744-01	Contact actuator, 8 N.C.
	ARP-29-7&1	10744-08	Contact actuator, 7 N.O. - 1 N.C.
	ARP-29-6&2	10744-07	Contact actuator, 6 N.O. - 2 N.C.
	ARP-29-5&3	10744-06	Contact actuator, 5 N.O. - 3 N.C.
	ARP-29-4&4	10744-05	Contact actuator, 4 N.O. - 4 N.C.
	ARP-29-3&5	10744-04	Contact actuator, 3 N.O. - 3 N.C.
	ARP-29-2&6	10744-03	Contact actuator, 2 N.O. - 6 N.C.
	ARP-29-1&7	10744-02	Contact actuator, 1 N.O. - 7 N.C.
8	ARP-49	10693-02	Contact holder
9	ARP-48C	10125-01	Armature
10	ARP-48D	12068-01	Clip
11	ARP-48I	12079-01	Core, coil
12	AC-17	12077-01	Coil, 110 VDC
	AC-18	12077-02, A-140-6021-02	Coil, 55 VDC (red lead)
13	ARP-48E	10750-02	Compression spring
14	ARP-48F	10658-01, B-419-0006-01	Frame
15	ARP-48G	10353-01	Mounting clip
16	ARP-48H	12072-01	Armature insulator
17	ARP-55A		Spring Seat
	ARP-50-44		Relay #2A 110V 4 N.O. 4 N.C. Contact
	ARP-51-44	11142-44	Relay #2A 55V 4 N.O. 4 N.C. Contact

Relay Parts

No. 3 Contactor

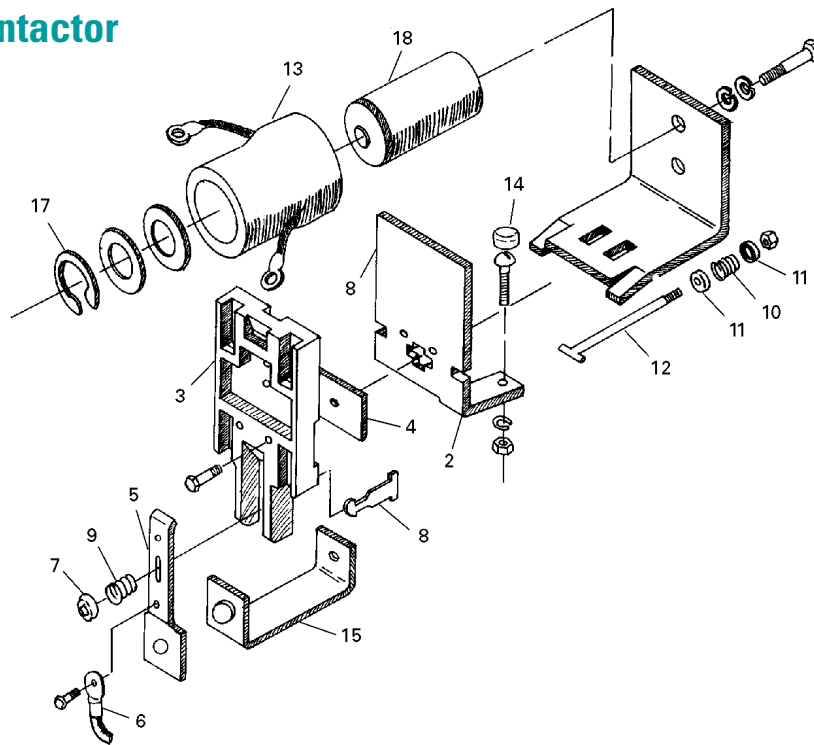

Item	S.E.E.S. #	O.E.M. #	Description
2	ARP-35A	10121-01, A006003	Armature
3	ARP-47	10441-01, B283004	Contact holder, movable
4	ARP-34D	10003-01, A001006	Adapter, plate
5	ARP-6A	10464-01, A32067	Silver contact, movable
6	ARP-10	10994-01, A521006	Shunt Lead (349-001)
7	ARP-15	10634-01, A171001	Cup washer
8	ARP-17A	10030-01, A002004	Contact anchor, Tee bridge
9	ARP-14	10746-01, A509023	Contact spring
10	ARP-13A	11994-01, A509022	Armature spring
11	ARP-15A	10635-01, A171002	Cup washer
12	ARP-17C	10356-01, A050003	Tee bolt
13	AC-1	10470-01	Coil, 270 VDC (MC1000; A0158-0002; B140-6011-01)
	AC-16	10472-01	Coil, 240 VDC (MC2500; A0158-0004; B140-6011-02)
	AC-2	10471-01	Coil, 80 VDC (MC218; A0158-0003; B140-6011-03)
	AC-20	13036-01	Coil, 110 VDC (A140-0585-01; B140-6011-04)
14	ARP-17E	12001-01	Rubber bumper
15	ARP-11	11156-01	Copper contact, Stationary
	ARP-11A	10465-01, A32066	Silver contact, Stationary
17	ARP-36B	10738-01, V468002	Retaining ring
18	ARP-36	10621-01, A165002	Core assembly

Relay Parts

No. 3A Contactor

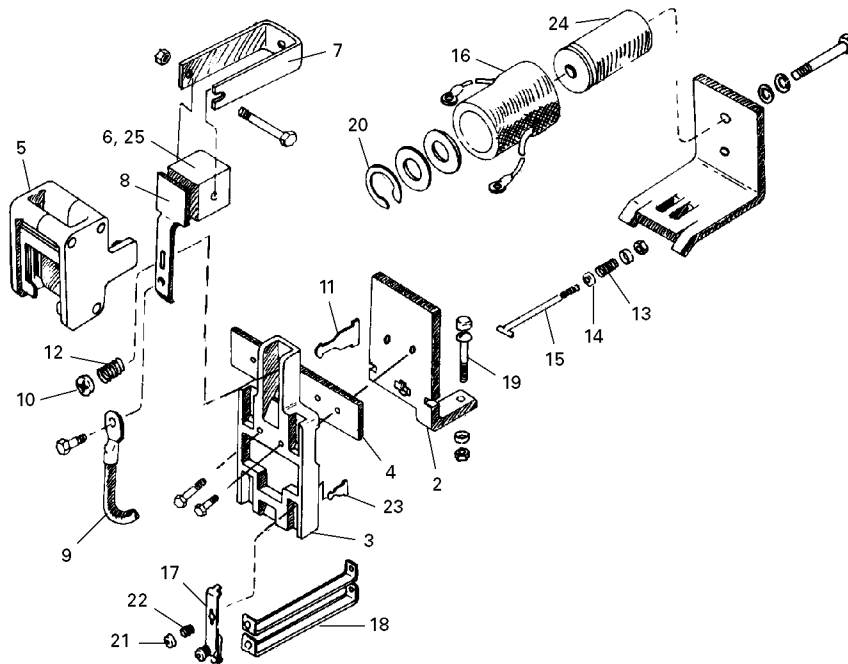

Item	S.E.E.S. #	O.E.M. #	Description
2	ARP-34A	10120-01, A006002	Armature, for 1, 2, & 3 pole
3	ARP-47	10441-01, A283004	Holder, for one movable contact
4	ARP-34B	10001-01, A001004	Adapter, 2 pole
	ARP-34C	10002-01, A001005	Adapter, 3 pole
	ARP-34D	10003-01, A001006	Adapter, 1 pole
5	ARP-32E	10064-01, B725004	Arc barrier assembly, A.C. 3"
6	ARP-4	11153-01, A164008	Contact, carbon stationary
7	ARP-3	10698-01	Holder, stationary contact
8	ARP-6	11151-01, A164006	Contact, main movable, 3-9/16" long
9	ARP-9	10742-01, A521004, 349-003-5	Shunt, movable contact, 11" long
10	ARP-15	10634-01, A171001	Cup washer
11	ARP-17A	10030-01, A002004	Contact anchor
12	ARP-14	10746-01, A509023	Contact spring
13	ARP-13A	11994-01, A509022	Armature spring
14	ARP-15A	10635-01, A171002	Cup washer
15	ARP-17C	10356-01, A050003	Tee bolt
16	AC-1	10470-01, A0158-0002	Coil, 270 VDC, (MC1000, B140-6011-01)
	AC-16	10472-01, A0158-0004	Coil, 240 VDC, (MC2500, B140-6911-02)
	AC-2	10471-01, A0158-0003	Coil, 80 VDC, (MC218, B140-6011-03)
	AC-20	13036-01, A140-0585-01	Coil, 110 VDC, (B140-6011-04)
17	ARP-20	10442-01, B756006	Contact assembly
18	ARP-26	11161-01, A164016	Contact, Stationary auxiliary, 3-17/32"
19	ARP-17E	12001-01, A045004	Rubber bumper
20	ARP-36B	10738-01, V468002	Retaining Ring
21	ARP-16	10636-01, A171003	Cup washer
22	ARP-12	10747-01, A509032	Contact spring
23	ARP-17B	10028-01, A002002	Contact anchor
24	ARP-36	10621-01, A768002	Core assembly
25	ARP-4A	11188-01, A164063	Contact, Stationary metallized carbon

Relay Parts

No. 5A Contactor

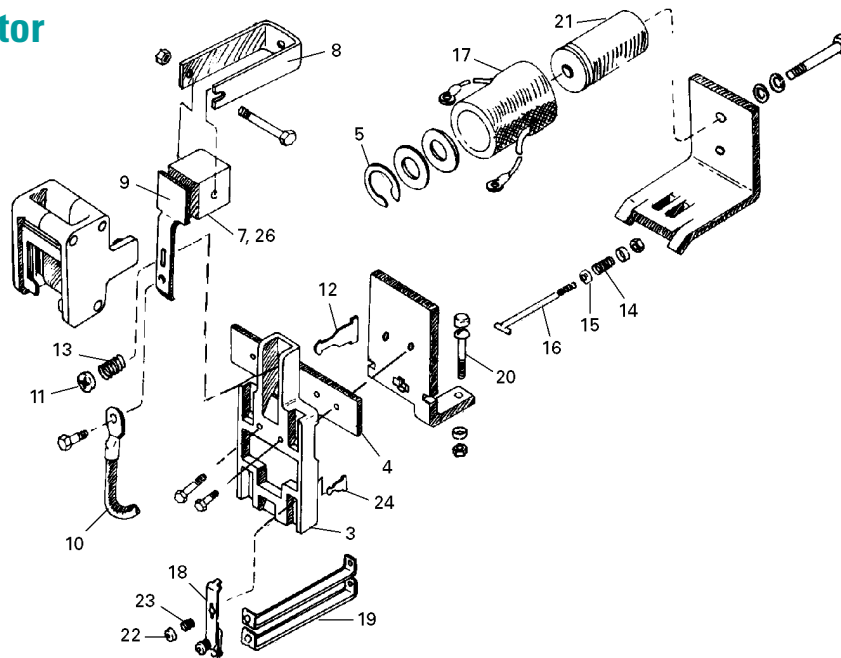

Item	S.E.E.S. #	O.E.M. #	Description
3	ARP-33	10695-01, A283006	Contact holder, for one movable contact
4	ARP-37A	10004-01, A001007	Adapter, 2 pole
	ARP-37	10005-01, A001008	Adapter, 3 pole
	ARP-37B	10006-01, A001009	Adapter, 1 pole
5	ARP-36B	10738-01, V468002	Retaining ring
7	ARP-2	11155-01, A164010, 10152-02, A164032	Contact, main stationary, standard duty, carbon Contact, main stationary, heavy duty, silver (tungsten)
8	ARP-1	10696-01, A283007	Stationary contact holder
9	ARP-5	11154-01, A164009, US504663	Contact, main movable standard duty, copper, 4-5/32" L
10	ARP-8	12148-01, A521005, 349-003-5	Shunt, movable contact, 13-1/4" L
11	ARP-15	10634-01, A171001	Cup washer
12	ARP-17A	10030-01, A002004	Contact anchor
13	ARP-13	10749-01, A509035	Contact spring
14	ARP-13A	11994-01, A509022	Armature spring
15	ARP-15A	10635-01, A171002	Cup washer
16	ARP-17C	10356-01, A050003	Tee bolt
17	AC-1	10470-01, A0158-0002	Coil, 270 VDC, (MC1000, B140-6011-01)
	AC-16	10472-01, A0158-0004	Coil, 240 VDC, (MC2500, B140-6911-02)
	AC-2	10471-01, A0158-0003	Coil, 80 VDC, (MC218, B140-6011-03)
	AC-20	13036-01, A140-0585-01	Coil, 110 VDC, (B140-6011-04)
18	ARP-20	10442-01, B756006	Contact, Auxiliary contact assembly
19	ARP-26	11161-01, A164016	Contact, Stationary auxiliary contact, 3-17/32" L
20	ARP-17E	12001-01, A045004	Rubber bumper
21	ARP-36	10621-01, A768002	Core
22	ARP-16	10636-01, A171003	Cup washer
23	ARP-12	10747-01, A509032	Auxiliary contact spring
24	ARP-17B	10028-01, A002002	Auxiliary contact anchor
26	ARP-2A	11187-01, A164062	Stationary contact, metallized carbon contact

Relays



PR-55



PR-53A



PR-7



PR-52



PR-36B

(Relay not included)



ACPM-001

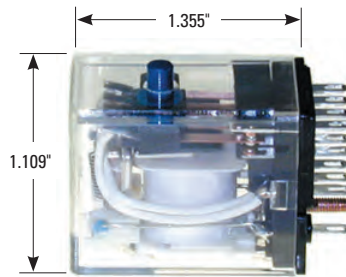

PR-64B

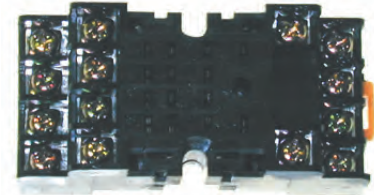

PR-89

S.E.E.S. #	O.E.M. #	Description
PR-55	11353-01	120 VAC 4 PDT
PR-56	11354-01	240 VAC 4 PDT
PR-54	11355-01	110 VDC 4 PDT
PR-64B	13602-01, 13633-01	48 VDC 4 PDT with Button & Light
PR-25A	13603-01, 13632-01	110 VDC 4 PDT with Button & Light
PR-89		Socket, Surface Mount

■ See also: PR-86, PR-87, PR-88 Sockets

P&B KUP Style

S.E.E.S. #	O.E.M. #	Description
PR-53A	11386-01	6 VAC 3 DPT
PR-15	11383-01	120 VAC 3 PDT with Button & Light
PR-18	11387-01	240 VAC 3 PDT with Button & Light
PR-71	13046-01	24 VDC 3 PDT
PR-22	11385-01	48 VDC 3 PDT with Button & Light
PR-21	11384-01	110 VDC 3 PDT with Button & Light
PR-32		Socket, surface mount

■ See also: PR-92, PR-93, PR-94 Sockets

S.E.E.S. #	O.E.M. #	Description
PR-7	11359-01	120 VAC DPDT
PR-3	11360-01	110 VDC DPDT
PR-6	11361-01	24 VAC DPDT
PR-9	11362-01	240 VAC DPDT

S.E.E.S. #	O.E.M. #	Description
PR-52	11340-01	Relay , 110 VDC, 3 PDT, replaces Guardian IR1225-3C-110D
PR-52A	13279-01	Relay , 110 VDC, DPDT, replaces Guardian IR1225-2C-100D
PR-52-KIT	11340-01 Alt	Guardian Kit Replacement , 3 PDT 110 VDC
PR-36A	12580-01	Socket , Panel Mount for 3P relays PR-52, PR-52A
PR-36B		Socket adaptor . This adaptor enables the use of KUP style 3 pole relays to replace the Guardian style. Plugs directly into the original Guardian relay socket. (Relay not included)

■ See complete listing of relays located in the Electrical Section starting on pg 283.

Phase Monitor

S.E.E.S. #	Description
ACPM-001	Phase Monitor, 250 VAC 15A, 3PH external

S.E.E.S. #	O.E.M. #	Description
ARP-31	11401-01	Overload Relay, 100 Amp
ARP-60	11356-01	Reverse Phase Relay, 208/220 VAC, New style replacement
ARP-60A	11357-01	Reverse Phase Relay, 80/85 VAC, New style replacement
ARP-61	12265-01	Contact, movable for 6572/2 Stahl
ARP-62		Contact, 40 AMP, 110 VDC Coil, 2 N.C., 4 N.O., 6571/1&2 Stahl
ARP-63		Contact, 80 AMP, 110 VDC Coil, 2 N.C., 4 N.O., 6573/1&3 Stahl
AC-28	10604-01	Coil for Stahl Contactors 6573/2 & 6574/2, 110 VDC
AC-29	10574-01, B733-9000-03	Replacement Coil, 208/220V for original reverse phase relay
AC-30	10576-01	Replacement Coil, 80/85V for original reverse phase relay



Switches

Magnetic Leveling Switches

S.E.E.S. #	O.E.M. #	Description
ARP-27	11845-01, B723006, B7230020	Magnetic leveling switch, variable voltage, yellow and black leads, N.C. contacts, PM #3
ARP-27A	13239-01, B723016	Magnetic leveling switch, variable voltage, red and black leads N.O., PM #3
ARP-27BA		Armor #1, 110V OPTO leveling rep kit
ARP-27DA		Armor leveling rep kit, N.C.
ARP-27-6A	10968-01	Nut, mounting for magnetic and photo switches
ARP-27-6B	10981-01	Stud, brass, mounting for magnetic and photo switches



Photo Switches

S.E.E.S. #	O.E.M. #	Description
ARP-27B	13626-01, 13817-8375	Photo switch #1, 110 VDC N.C.
ARP-27D	13626-03	Photo switch #3, 24 VDC N.C.
ARP-27G	13626-04	Photo switch #4, 24 VDC N.O., 4 wire



Limit Switches

S.E.E.S. #	O.E.M. #	Description
ARP-27C	11858-01, 11859-01, B723002, B723001	Limit switch replacement kit Kit includes all parts required to replace both #3 Limit switches. This part is a replacement kit for old style, N.O. & N.C.
ARP-27C-HDW		Hardware Kit, for ARP-27C Bracket & hardware
ARP-27F		Limit Switch N.O./N.C., only, (included in above kit)

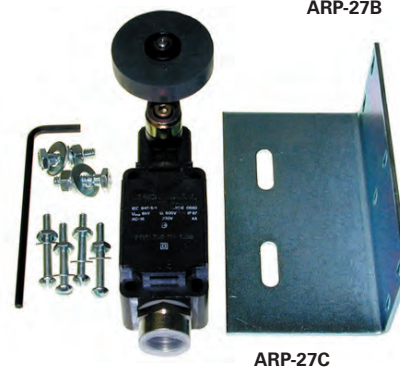

Machine Seals and Bearings



PAC-46



ABR-1



PAC-46A

S.E.E.S. #	O.E.M. #	Description
PAC-46	12331-01	Oil seal, split, for #2 and #2BB machines, 1-3/4" x 2-3/4" x 1/2"
PAC-46A	12080-02	Oil seal, split, for #3 machine, 1-15/16" x 2-7/8" x 1/2"
PAC-46B	12081-01	Oil seal, split, for #4 and #4BB machines, 2" x 3" x 1/2"
PAC-46C	12332-01	Oil seal, split, for #5 and #5BB machines, 3" x 4" x 3/8"
PAC-46D	12611-01	Oil seal, split, for #7 machine, 4" x 5" x 7/16"

S.E.E.S. #	O.E.M. #	Description
ABR-1	12911-01	Bearing for #2 Machine worm shaft thrust
ABR-2	12912-01	Bearing for #3 Machine worm shaft thrust
ABR-3	12913-01	Bearing for #4 Machine worm shaft thrust
ABR-4	12914-01	Bearing for #5 Machine worm shaft thrust

Brake Components



AM-1



AM-2



AM-3



AM-4



AM-5

S.E.E.S. #	O.E.M. #	Description
AM-1	13495-01, 513803	Brass brake sleeve assembly for #4 Machine
AM-2	13614-01, 516519	Brake plunger and rod assembly for #4 Machine
AM-3	US513154	Brake Sheave, Brass #2 and #3
AM-4	US516195	Belt, for Tach
AM-5	US515816	Brake plunger & rod assembly, for #2 & #3 Machine
AM-6		Pin, Brake, Brass Rod, 5/8" O.D. x 6.75" L

Selector Parts

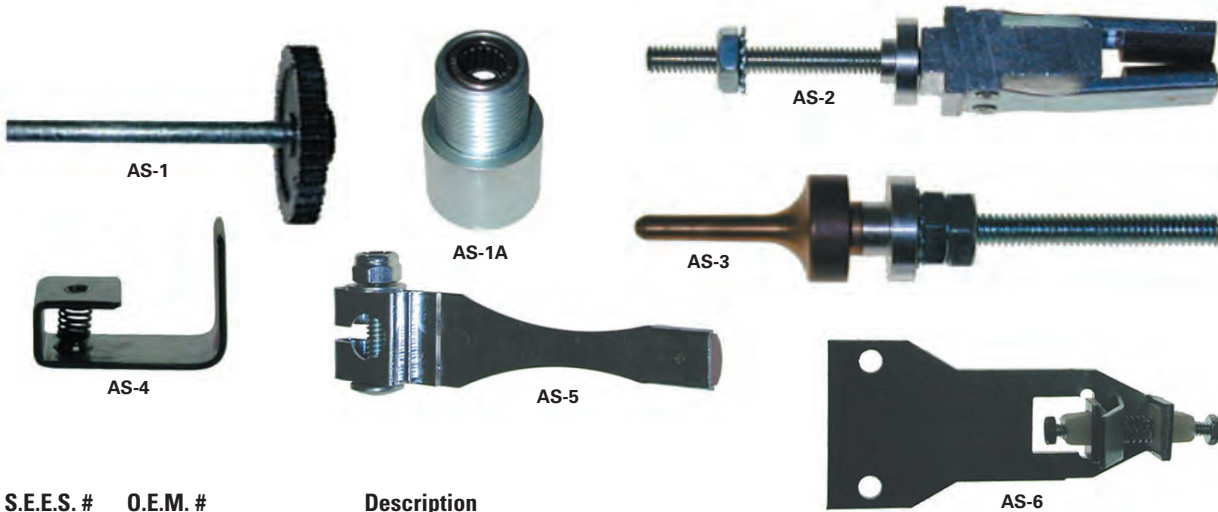

S.E.E.S. #	O.E.M. #	Description
AS-1	10661-01, B252003	Gear and shaft for O.E.M.#1 Stepping Relay
AS-1A	10337-01	Bushing assembly for stepper
AS-4	10662-01, B286028	Housing with ball and spring
AS-5	10069-01, B008034	Arm and contact brush assembly for #1 Stepping Relay
AS-2	10358-01, A363G1, A4747492	Selector brush with metal contacts 1-11/16", for graphite KM White style selector
AS-3	10982-01, A2949	Stud , stationary contact, 1/8" diameter point x 2" overall, for KM White style selector
AS-6	10137-01, B008026	Stepping arm pawl assembly
AS-7	10712-01, A405002	Pawl , stepper
AS-8	11173-01, A164031	Contact , brass stationary, intermediate
AS-9	11172-01, A164030	Contact , brass stationary, L.H.
AS-10	11171-01, A164029	Contact , brass stationary, R.H.
AS-11	10357-01, A767001	Brush assembly for #1 Stepping Relay
AS-12	10978-01/02	Selector tape , perforated spring 7900-200 steel for Armor & KM White selectors, cut to required length
AS-13	13427-01, A111-0586-01	Cam , Advancer Selector

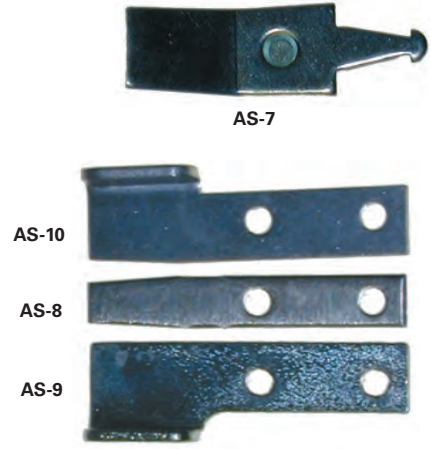

Transformers

Single-Phase Transformers



S.E.E.S. #	O.E.M. #	Description					
ATF-2	11758-01, B10825	75 VA	Primary	85 Volts	Secondary	35-40-45 Volts	
ATF-3	11810-01, V0611011	75 VA	Primary	208-230 Volts	Secondary	35-40-45 Volts	
ATF-4	11764-01, B4685	100 VA	Primary	240-220-200-180 Volts	Secondary	25 Volts	
ATF-5	11769-01, B4685	100 VA	Primary	240-220-200-180 Volts	Secondary	12-14-16 Volts	
ATF-6	13530-01, B905-0593-01	100 VA	Primary	480-240 Volts	Secondary	120 Volts	
ATF-7	13532-01, B905-0584-01	100 VA	Primary	85 Volts	Secondary	10-12-14 Volts	
ATF-8	13533-01, B905-0584-02	100 VA	Primary	85 Volts	Secondary	25 Volts	
ATF-9	11811-01, V06110003	150 VA	Primary	208 Volts	Secondary	55-65-75 Volts	
ATF-10	11765-01, B3136	250 VA	Primary	240-220-200-180 Volts	Secondary	25 Volts	
ATF-11	11774-01, B851	250 VA	Primary	240-220-200-180 Volts	Secondary	60 Volts	
ATF-12	11802-01, B36210, B905-0023-01	250 VA	Primary	240-220-200-180 Volts	Secondary	150-115 Volts	
ATF-13	11812-01, B905-0024-60	250 VA	Primary	85 Volts	Secondary	35-45 Volts	
ATF-14	13531-01, B905-0585-01	250 VA	Primary	85 Volts	Secondary	25 Volts	
ATF-15	11766-01, B3137	500 VA	Primary	240-220-200-180 Volts	Secondary	25 Volts	
ATF-16	11770-01, B5798	500 VA	Primary	480-460-440-420 Volts	Secondary	230 Volts	
ATF-17	11800-01, B36200	645 VA	Primary	240-220-200-180 Volts	Secondary	115-230 Volts	
ATF-19	11803-01, B36371	750 VA	Primary	240-220-200-180 Volts	Secondary	220 Volts	
ATF-20	11771-01, B6259	1 KVA	Primary	240-220-200-180 Volts	Secondary	25 Volts	
ATF-21	11777-01, B8634	1 KVA	Primary	480-460-440-420 Volts	Secondary	230 Volts	
ATF-22	11782-01, B10826	1.5 KVA	Primary	240-220-200-180 Volts	Secondary	25 Volts	
ATF-23	11801-01, B36201	1.5 KVA	Primary	480-460-440-420 Volts	Secondary	115-230 Volts	
ATF-24	11804-01, B36374	1.5 KVA	Primary	240-220-200-180 Volts	Secondary	220 Volts	
ATF-25	11805-01, B36375	1.5 KVA	Primary	480-460-440-420 Volts	Secondary	220 Volts	

Transformers

Three-Phase Transformers

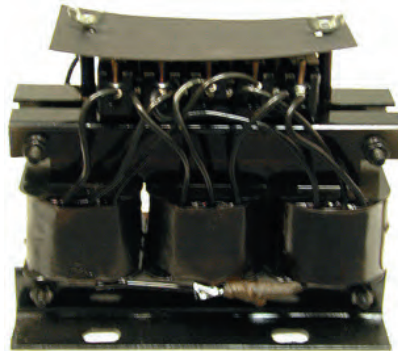

ATF-26

S.E.E.S. #	O.E.M. #	Description
ATF-26	11790-01, B905-0587-01	500 VA Primary 200-208-215-220 Volts Secondary 85 Volts
ATF-29	13536-01, B905-0588-01	1 KVA Primary 200-208-215-220 Volts Secondary 85 Volts
ATF-32	13539-01	1 KVA Primary 200-208-215-220 Volts Secondary 210 Volts
ATF-33	13540-01, B905-0588-07	1 KVA Primary 230-240-248-255 Volts Secondary 210Volts
ATF-34	13541-01, B905-0588-08	1 KVA Primary 465-480-495-510 Volts Secondary 210 Volts
ATF-36	13543-01, B905-0589-07	3 KVA Primary 230-240-248-255 Volts Secondary 210 Volts
ATF-37	13544-01, B905-0589-08	3 KVA Primary 465-480-495-510 Volts Secondary 210 Volts
ATF-39	13546-01, B905-0590-07	5 KVA Primary 230-240-248-255 Volts Secondary 210 Volts
ATF-40	13547-01, B905-0590-08	5 KVA Primary 465-480-495-510 Volts Secondary 210 Volts

■ S.E.E.S. maintains an extensive inventory of transformers to meet your needs Same day shipping available to serve any emergency. We welcome your inquiries and any suggested additions to our stock.

Door Equipment

Rollers & Roller Assemblies

S.E.E.S. #	O.E.M. #	Description
ADO-7	11921-01, A466022	Roller assembly, 1-1/4" O.D. with 2-3/4" shaft for lever
ADO-7A	11921-02, A466022	Roller assembly, 1-1/4" O.D. with 4" shaft for lever
ADO-7B	11912-01, B466005	Roller, 1-1/4" O.D.
ADO-7C	12161-01, A466026	Roller assembly, 1-1/4" O.D. with 1-7/8" threaded shaft for gate switch
ADO-7D	12161-02, A466026	Roller assembly, 1-1/4" O.D. with 3-1/32" threaded shaft for gate switch
ADO-7E	12005-01	E-Clip for 3/8" shaft diameter
ADO-12	11971-01, A776005	Eccentric upthrust roller, steel roller, 1-1/6" O.D. for #4. Hatch door hanger assembly
ADO-12A	11972-01, A776010	Eccentric upthrust roller, steel roller, 1-1/2" O.D.
ADO-12B	13240-01	Eccentric upthrust roller, 15/16" diameter, steel
ADO-12C	12576-01	Eccentric upthrust roller, 1-3/4" diameter, steel (concave)



Wheels and Roller Assemblies



Hanger Assemblies

S.E.E.S. #	O.E.M. #	Description
AW-1	12103-01, B733004	Hanger assembly with 3-1/4" steel roller
AW-2	11930-01, B025014	Roller, Steel, 3-1/4" diameter
AW-3	12103-01, B733004	Hanger assembly with 3-1/4" polyurethane roller
AW-4	B491115	Roller, Polyurethane 3-1/4" diameter
AW-13	12419-01, C748003	Sheave assembly for #7 car door hanger
AW-8	11943-01, V654002	Wiper for #4, #7 Door hanger sheave assembly
AW-11B	12094-01, A050035	Bolt, 3-5/16", for car door hanger
AW-11C	13312-01, A050035	Bolt, 6-5/16", for car door hanger
ADO-12A	11972-01, A776010	Roller, steel eccentric upthrust roller, 1-1/2" diameter

Hanger Wheels

S.E.E.S. #	O.E.M. #	Description
AW-11	11929-01, A491101	Sheave, 3-3/8" O.D., .6693 I.D., #7 Car door hanger ■ For concave track
AW-11A	11929-03	Sheave, 3-3/8" O.D., .6693 I.D., #7 Car door hanger. Machined aluminum with polyurethane tire. ■ For flat track
AW-9	11939-01, B653002	Roller Guide Wheel, 7" O.D. with threaded eccentric shaft. Threaded shaft 5/8-11" jam nut, 3-1/2" overall length. Tire face 1/2" wide, hub width 1-1/8"
AW-9A	11940-01, B653003	Roller Guide Wheel, 7" O.D., double bearing, .6693 I.D. Tire face is 1/2" wide, hub width is 1-1/8" wide. Similar to AW-9 but without eccentric.
AW-9B		Bushing for AW-9A and AW-10 (2 needed per assembly)
AW-9AH	11940-01, ARW422	Roller Guide Wheel, 7" O.D. x .67" I.D. w/o Eccentric, HD 90 Duro
AW-9H	11939-01, ARW423	Roller Guide Wheel, 7" O.D. x .67" I.D. w/ Eccentric, HD 90 Duro
AW-10	11942-01, B653010	Counterweight Roller Guide Wheel, 3-1/2" O.D., tire face 1/2" wide, hub 1.05" W double bearing, .6693 I.D.
AW-10A	11941-01, B653009	Counterweight Roller Guide Wheel, 3-1/2" O.D., double bearing with eccentric shaft, 1/2-13 hex nut, 1" long
AW-14	168962G01, 515606	Roller Guide Wheel, 7-7/8" O.D., Tire face .375" wide, Hub 1-1/2" wide, Double bearing with shaft, 2-3/4" overall length

DOVER

QUICK LOCATOR GUIDE

Belts	560
Brushes And Brush Holders	561
Car Signal Components	540-560
Emergency Light Components	556-577
Emergency Stop Switches	540
Gongs and Buzzers	560
Hall Lantern	544
Hall Station Assemblies	545
Key Switches, Keys	542-543, 549-555
Lamps, Lamp Holders	544-545
Position Indicator Components	544, 548, 559
Pushbutton Assemblies	541, 547
Capacitors	564
Carbon Contacts And Holders	561
Coils	565
Contacts And Contact Kits	562-564
Contactors, Starters	564, 590-591
Door Parts And Equipment	566-574
Clutch Components	572
Gibs, Guide Shoe	569-570
Hatch Equipment	574
Interlock Components	567
Motors	571
Operator, DMC	573
Pick-up Roller Assembly	566
Restrictor Assemblies	573
Encoders and Tachometers	575
Fan / Blower	586
Machine Parts	575-577
Printed Circuit Boards	578-585
Rectifiers	582, 586
Relays	587-590
Resistors	587
Safety Edge Equipment	592-593
Selector Parts	594-597
Transformers	598
Valve Components	598-600
Wheels and Rollers	600-602

Car Signal Components

DOVER

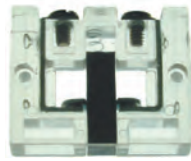

DB-5



DB-6



DB-6A

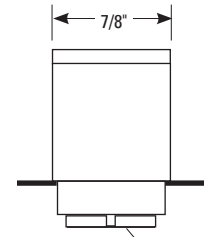

DB-6C

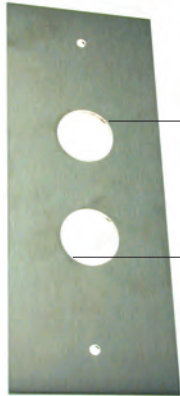

DB-14



DB-7

2-3/8"
c/c



DB-7A

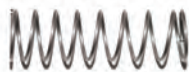

DB-80



TPB-004



TPB-213



DB-3A



DB-3D



DB-3B

S.E.E.S. #	O.E.M. #	Description
DB-1M	9827018	Pushbutton, Microswitch replacement for DB-1, 2, 3
DB-1M-SPECIAL		Pushbutton, Microswitch with Special Engraving & Lamp Holder
DB-3M	9930840	Pushbutton Assembly, Stop-FR
DB-5	9724522, 32455	Contact assembly, normally closed
DB-6-	9852130, 9850119	Pushbutton, 7/8" diameter x 1-5/32" long, black button with white character, specify marking, i.e. DB-6-2
DB-6A	9724989, 32489	Push plate, for button
DB-6C	32491	Retaining ring, for push plate
DB-7	9724588	Car Halo for pushbutton, 1-3/8" O.D. x 7/8" I.D.
DB-7A	9828230	Pushbutton Halo, back mounting, white halo for DB-6 button
DB-7B	9828199	Pushbutton Halo, back mounting, black halo for DB-6 button
DB-80	780AD1	Pushbutton Spring, V-7 Dover impulse switch
DB-13	9826919	Plate, stainless steel, 3-1/2" x 9" with single 1-1/4" dia. hole, mounting studs 7-1/8" c/c
DB-13A		Terminal Hole Plate, DB-8F-ARROW-ADA 3-3/8" x 9-3/4", 7-1/2" C-C Holes
DB-14	9826920, 9832609	Plate, stainless steel, 3-1/2" x 9" with two 1-1/4" dia. holes 2-3/8" c/c, mounting studs 7-1/8" c/c
DB-14A	9826920,	Terminal Hole Plate, DB-8F-ARROW-ADA 3-3/8" x 9-3/4", 7-1/2" C-C Holes
DB-14A-CB		Intermediate Hole Plate, DB-8F-ARROW-ADA (1) Code Blue Keyswitch, 3-1/2" x 9", 7-1/2" C-C Holes
TPB-004	9846352	Contact, Pushbutton
TPB-RING		Vandal Ring, for TPB Series
TPB-213	9872314	Button, Vandal Resistant Calif V10
TPB-200	9739490	Button, Blank Stainless for Vandal Resistant
TPB-002	9835641	Pushbutton, 24V Vandal Resistant, LED illuminated

Emergency Stop Switch

S.E.E.S. #	O.E.M. #	Description
DB-3A	9810857, 108150	Stop switch assembly, horizontal, red button 1-1/4" dia., 1 Make 1 Break, marked "PUSH STOP/PULL RUN"
DB-3B	9810985, 109888	Stop switch assembly, horizontal, red button 1-1/4" dia., marked "PUSH INSPECTION/PULL AUTO or PULL RUN", 1 Make 1 Break
DB-3D	9810845	Stop switch assembly, vertical, red button 1-1/4" dia., marked "PUSH STOP/PULL RUN", 1 Make 1 Break

Car Signal Components

S.E.E.S. #	O.E.M. #	Description
DB-3E		Key Switch , halo marked "DOOR HOLD", 2 position, key removable in OFF only, H2395 key, black, round bezel
DB-3F		Key Switch , halo marked "RUN/STOP", 2 position, key removable in ON only, H2395 key, red, round bezel
DB-3F-BLK		Key Switch , Run-Stop, Rnd Black 2 Pos, 2Rmv, H2395 Key
DB-3F-SH		Key Switch , Run-Stop 1-1/4" SQ 2 Pos, Rmv1, Horiz, H2395 Key, square bezel
DB-3F-SV		Key Switch , Run-Stop 1-1/4" SQ 2 Pos, Rmv1, Vert, H2395 Key, square bezel



DB-3E



DB-3F

Toggle Style Stop Switch

S.E.E.S. #	O.E.M. #	Description
DS-52	171AR46	Switch
DB-53	32554	Halo , black, marked "RUN/STOP", for toggle switch, 1-1/4" diameter, plate 1.56 x 2.44, 2" c/c mounting
DB-53A	42823	Halo , blank, black, for toggle style stop switch
DB-53B		Halo , black, marked "DOOR HOLD", for toggle switch
DB-53C	138595	Spacer , Round for Pushbutton
DB-54	32553	Bracket for toggle stop switch, 3/4" x 2-3/8" plate
DB-55	9867053, 76705	Switch , 3 PDT, two position, run/stop, 1.1" x 1.33"



DB-53



DB-54



DB-55

Pushbutton Assembly

Item	S.E.E.S. #	O.E.M. #	Description
1	DB-8CADA	9773150	Clear cap , Dover Calif. Code ADA 138354
2	DB-8-ADA	9806738, 106733	Clear cap for pushbutton, 1" diameter x 1/4"
3	DB-8B-"*" -ADA	98930-1, 9890087, 9890129	Button , new ADA style, specify marking, i.e. DB-8B-1-ADA, shown
4	DB-8E	9884063, 107406	Base assembly , 1 normally open, 1 normally closed contact
	DB-8D	9884075, 107407	Base assembly , 2 normally open contacts
5	ML-57	9727190	Lamp , 28 volt, #657
	ML-57-LED-W		Lamp , White 28V LED 4 Chip T3 1/4 Wedge 657 LED white
6	DB-52C	9778147, 10814	Lamp socket with resistor
6	DB-52D	9727164, 9711065	Lamp socket without resistor
	DB-52G	701AB2	Resistor Assembly , 600 Ohms
	DB-52H	900AB16	Wire Assembly , 20GA 110/187 4" Lg
	DB-52F	9719568	Resistor Assembly , 5W 600 Ohms
	DB-8F-"*" -ADA		Pushbutton Assembly , 2 normally open base, new ADA style, specify marking, i.e. DB-8F-1-ADA, shown
	DB-8F-CODE-BLUE-ADA		Pushbutton Assembly , P.B. Indicator, Marked "Code Blue"
	DB-8G-"*" -ADA		Pushbutton Assembly , 1 N.O., 1 N.C., new ADA style, specify marking
	DKS-8-BLANK-H		Bezel , adapts 1-1/4" Round button to keyswitch, horizontal
	DKS-8-BLANK-V		Bezel , adapts 1-1/4" Round button to keyswitch, vertical
	ML-108-LED-W	175AC1	LED , White 85 LED with socket
	DB-8C	9806349	Halo , for new style button



1



2



3



4



5



6



DB-8F-1-ADA



DKS-8-BLANK-H



DB-8C



DB-8F-CODE-BLUE-ADA



DB-8G-G-ADA

Car Signal Components

■ Select one from each section below (1 Rotary Switch, 2 Key Cylinder, and 3 Key Switch Collar) along with a DKS-1B mounting bracket to make a complete switch assembly.



DK-3



DK-4



DK-5



DKS-1A, DKS-2A, DKS-2B



DKS-1B



DKS-76D



DKS-76C



DKS-76E



DKS-8-OFF-ON-FIRE-BY

Rotary Key Switch Assembly

1 – ROTARY SWITCHES

S.E.E.S. #	O.E.M. #	Description
DK-3	H2111	Key H-2111
DK-4	H2007	Key H-2007
DK-5	H2011	Key H-2011
DKS-1	9772870, 77287	Rotary switch, 2 position, ON-OFF
DKS-1A		Key switch, rotary switch 2 position DPDT
DKS-2	9772868, 77286	Rotary switch, 3 position, ON-OFF-ON
DKS-2A		Rotary switch, 3 position, ON-ON-ON Old Style SP3T, Enclosed Switch
DKS-2B	102761	Rotary switch, 3 position, ON-ON-ON New Style Open Face Switch
DKS-1B	9826099, 32609	Bracket, mounting
DKS-1BA		Bracket, for key switch (new style)
DKS-76D		Keyswitch, 2 Pos. Remove 2, Keyed to 2252

2 – KEY CYLINDERS

S.E.E.S. #	O.E.M. #	Description
DKS-3A	9703135	Key H-2395
DKS-4A	9703196	Key H-2389 (Restricted Fire Service Key)
DKS-5A	9703202	Key H-2304
DKS-6	9759542, 35954	Special key cylinder, Two H-2454 keys
DKS-6A	9703214	Key H-2454
DKS-7	9759554, 35955	Special key cylinder, Two H-2567 keys
DKS-7A	9703240	Key H-2567
DKS-8A	9703299	Key H-2573
DKS-12A	9703160	Key H-2237
DKS-76A	9721654	Key H-2165
DKS-76B	H2252	Key Access chair lift H2252 Thyssen
DKS-76C		Key Switch 2 POS. Remove 1, Keyed to 2252
DKS-76E		Key Switch 2 POS. Remove 1, Keyed to 2252, Spring Loaded
DKS-21A	9710280	Key H-5009

3 - KEY SWITCH COLLARS

■ Collar 1-1/4" diameter. Markings are listed in the order that they appear, the first marking is at the 12 o'clock position; unless otherwise noted. Subsequent markings are in the 3 o'clock position, following clockwise to the next position. i.e. DKS-8-OFF-ON-FIRE-BYP, pictured. OFF (12 o'clock position) ON (3 o'clock position) FIRE (6 o'clock position) BYPASS (9 o'clock position).

S.E.E.S. #	O.E.M. # / Marking
DKS-8-ATT-ON-SERVICE	32738/Attendant-On-Service
DKS-8-BLANK	9822987/blank, black collar
DKS-8-BLANK-RED-BYP	117560/Key Core, red blank, for bypass halo
DKS-8-RED BLANK	117559/blank, red collar
DKS-8-DOOR-HOLD	Door-Hold (6)
DKS-8-EMER-ON-POWER	32743/Emergency-On-Power
DKS-8-EMER-ON-SERVICE	32737/Emergency-On-Service
DKS-8-FAN-OFF	32751/Fan-Off (9)
DKS-8-FLOOR-ON-LOCK	Floor-On-Lockout
DKS-8-HOLD-ON-FIRE-OFF	Red Hold-On-Fire-Off, Phase II Car
DKS-8-IND-ON-SERVICE	32736/Independent-On-Service
DKS-8-INDEP-SERVICE	Independent-Service (6)
DKS-8-INSPECTION-ON	32740/Inspection-On
DKS-8-LIGHT-FAN-OFF	32744/Light-Fan-Off (9)
DKS-8-LIGHT-OFF	32750/Light-Off (9)

S.E.E.S. #	O.E.M. # / Marking
DKS-8-MG-OFF	32741/MG-Off (9)
DKS-8-OFF-DN-HOISTWAY	Off-Dn-Hoistway Acc.-Up
DKS-8-OFF-ON	Off-On
DKS-8-OFF-ON-FIRE-BYP	Red Off-On-Fire-Bypass, Phase I Hall (new style) used only with DKS-2B
DKS-8-OFF-ON-FIRE-BY	Red Off-On-Fire-Bypass, Phase I Hall (old style) used only with DKS-2A (shown above)
DKS-8-OFF-ON-FIRESVC	Off-On-Fire Service
DKS-8-OFF-ON-INSPECT	Off-On-Inspection
DKS-8-ON-OFF	32753/On-Off (9)
DKS-8-PHOTO EYE-OFF	32742/Photo Eye-Off (9)
DKS-8-RUN-STOP	Run-Stop-Emergency
DKS-8-SERVICE-ON	32754/Service-On
DKS-8-SPEC-ON-SERV	32752/Special-On-Service

Car Signal Components

Toggle Key Switch Cylinders Non-Spring Return Key Removable "OFF" Position Only

S.E.E.S. #	O.E.M. #	Description
DKS-9	9759591, 35959	Standard key cylinder with two H-2395 keys
DKS-9A	9759797, 35979	Standard key cylinder with two H-2192 keys
DKS-9A-A	9703226	Key H-2192
DKS-9B-A	9703172	Key H-2399
DKS-9C-A	9703184	Key H-2448
DKS-10	9759610, 35961	Special key cylinder with two H-2304 keys
DKS-11	9859627, 35962	Special key cylinder with two H-2454 keys
DKS-12	9759803, 35980	Special key cylinder with two H-2237 keys
DKS-9B	9759815, 35981	Special key cylinder with two H-2399 keys

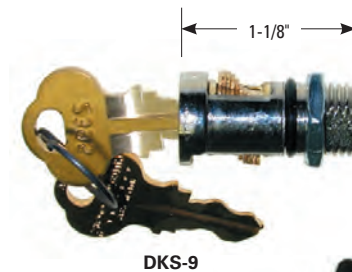

Toggle Switch

S.E.E.S. #	O.E.M. #	Description
DKS-1B-1A	9726287	Toggle Switch, SPDT, spring return
DKS-1B-2A		Toggle switch, DPST, 2 position ON/OFF
DKS-1B-1C	32631	Cam actuator 5/16" Slot for Toggle
DKS-1B-1D	35918	Washer, tab for bracket keyswitch
DKS-1B-1E	35344	Cam actuator 5/8" Slot for Toggle

Key Switch Assemblies Special Function

S.E.E.S. #	Description
DB-3E	Key Switch, black halo marked "DOOR HOLD", 2 position, key removable in ON only, H2395 key
DB-3F	Key Switch, red halo marked "RUN/STOP", 2 position, key removable in RUN only, H2395 key
DB-3J	Key Switch, black halo marked "OFF/ON", 2 position, removable in both, SEES. #2 key

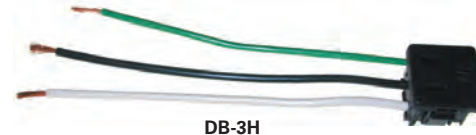

Car Top Inspection Station Components

S.E.E.S. #	O.E.M. #	Description
DB-3A	9810857, 108150	Stop switch assembly, horizontal use, 1 Make 1 Break, red button 1-1/4" diameter, marked "PUSH STOP/PULL RUN"
DB-3B	9810985, 109888	Stop switch assembly, horizontal use, red button 1-1/4" diameter, marked "PUSH INSPECTION/PULL AUTO"
DB-3G	76703, 9743637	Light Switch for Car Top Inspection Station marked ON/OFF
DB-3H	76704	Receptacle for Car Top Inspection Station
MIS-147	109789	Lamp Guard, metal clamp on guard for Car Top Inspection Station



Car Signal Components



DB-10-



DB-11-

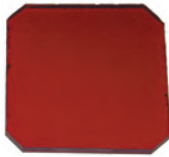

DB-12B



DB-69



DB-12



DB-59

Lighting

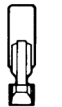

Fig. 1



Fig. 2



Fig. 3



Fig. 4



Fig. 5

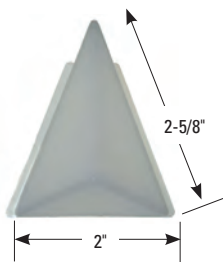

Fig. 6

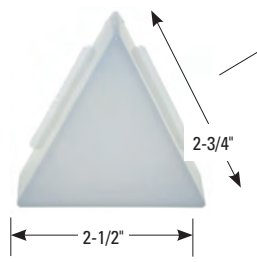

Fig. 7

■ This is a partial listing of Dover lamps. Additional lamps, including LED options, are listed in the Lighting Section.



DB-9



DB-9A

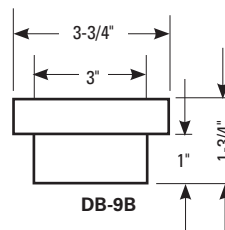

DB-9B-A



DB-9B-A

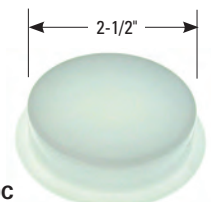

DB-9C

S.E.E.S. #	O.E.M. #	Description
DB-10-	9724-series	Position indicator lens , 1-5/8" square white lens with black character. Specify marking, i.e. DB-10-UP ARROW
DB-11-	9825-series	Position indicator lens , inclined white lens with black character. 1-3/8" height, 1-5/16" wide. Specify marking, i.e. DB-11-B
DB-12	9872097, 9863503	Lamp housing for position indicator, used with DB-52E
DB-52E	9851975, 35197	Lamp holder used with DB-12 for PSB type lamps
DB-12A	9863515, 76351	Lens , white frosted, for P.I., 1-9/16" square
DB-12B	9863527, 76352	Lens , red, for P.I., 1-9/16" square
DB-12C	9863539, 76353	Lens , green, for P.I., 1-9/16" square
DB-59	9719532	Fire Hat Jewel Assembly Square - Red Bezel 24V
DB-69	9724400	Divider for DB-11 position indicator

Lamps

Fig.	S.E.E.S. #	O.E.M. #	Lamp Description
1	ML-1	9769377, 76937	120 PSB
1	ML-3	9871664, 77167	48 PSB
1	ML-5	9871688, 77168	24 PSB
2	ML-57	9727190, 107189	#657, 28V
2	ML-93	A493L6	#161, 14V
3	ML-108	9721769, 175AA1	#85, 28V
4	ML-18	32462	6S6/120V
4	ML-15	32463	10S6/ 250V
5	ML-90	32464	25T8C, 120V
6	ML-67	32461	T4-1/2, 120V
7	ML-31	108248, 9782485	#503, 5.1V

Lantern Lenses

S.E.E.S. #	O.E.M. #	Description
DB-9	9863552	Arrow , for hall lantern signal. White arrow manufactured in durable Lexan
DB-9A	124081, 9722129	Hall lantern arrow , 2-3/4" x 2-1/2" white triangular arrow has smooth surface, mounting tabs hold it securely in place
DB-9B	138107	Lantern lens , 3-3/4" diameter, white frosted round lens
DB-9B-A		Lantern lens , 3-3/4" diameter 2" w
DB-9C	9730205	Lantern lens , 2-1/2" diameter
DB-9D	61491	Cab Fixture , Lens, Arrow

Lamp Holders

S.E.E.S. #	O.E.M. #	Description
DB-29	9727152, 138AD1	Lamp holder assembly for ML-108 lamp
DB-52	9772509, 770AE1	Lamp holder for ML-108 lamp
DB-52A	9711892, 9724710	Lamp holder assembly with resistor 1.2K, for P.I., Hall Station
DB-52B		Lamp holder assembly, same as above but without resistor
DB-52C	9778147, 108149	Lamp holder assembly with resistor for ML-93 & ML-57
DB-52D	9727164	Lamp holder assembly, same as above but without resistor
DB-52E	9851975, 35197	Lamp holder for PSB lamps



DB-52



DB-52E



DB-52A



DB-52C

Car Signal Components

Hall Station Assemblies

S.E.E.S. #	O.E.M. #	Description
DB-15A	176AL1	Terminal hall station assembly complete, Stainless steel plate, 9" x 3-1/2", complete with pushbutton module. Single white square button assembly and directional arrow.
DB-15A-1	9832646	Stainless steel plate, single rectangular opening 1-1/4" x 2-1/2"
DB-15A-1A		Terminal Hall Plate, 1.25" Square Hole, with studs
DB-15A-1B		Terminal Hall Plate, 1.25" Square Hole, with vertical studs
DB-15AE		Terminal Hall Station, Extended 11.75" x 3.375" Single Hole
DB-15B	176AL5	Intermediate hall station assembly complete, Stainless steel plate, 9" x 3-1/2", complete with two white square button assemblies and directional arrows.
DB-15BE		Intermediate Hall Station, Extended 11.75" x 3.375" Double Hole
DB-15B-1	9832658	Stainless steel plate, 9" x 3-1/2", double rectangular opening 1-1/4" x 2-1/2" each
DB-15C		Rear box cover, Galv Steel H 8.125" x W 2.5"
DB-15D	9828369	Hall Plate, Terminal with Fire Service PH1, 12" x 3.5"
DB-15D-1		Hall Plate, Terminal 3 Hole, 12" x 3.5"
DB-58	9780439	Impulse Fixture



DB-15A

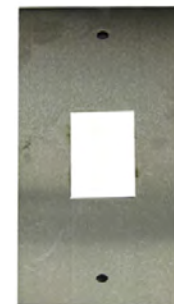

DB-15A-1



DB-15AE

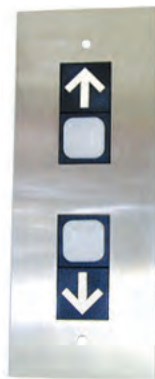

DB-15B



DB-15BE

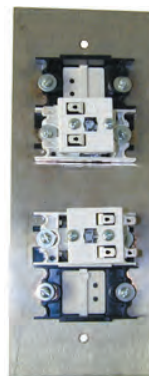

DB-15B (rear shot)



DB-15B-1



DB-15C



DB-15D

Car Signal Components

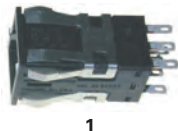
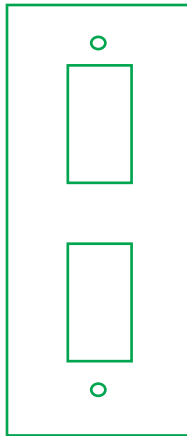

1



3



7



8



11



2



5

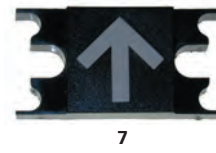

7

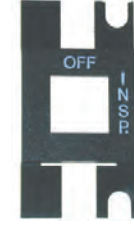

9



12



4



6

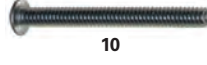

10

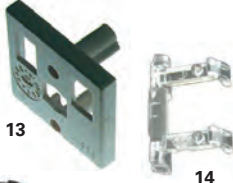

13



14



15



16



17



17



DB-44-1



DB-44-BLANK



DHDW-002

■ Items 1-6 are for the older style pushbutton assembly and are sold separately. Items 2, 5, 6, 13-17 are for the newer style pushbutton assembly and are sold separately and as a complete assembly, see below DB-77A, DB-77B and DB-77C.

Hall and Car Station Components

Item	S.E.E.S. #	O.E.M. #	Description
1	DB-16	9891717, 171AE1	Switch, 2 pole pushbutton switch
2	ML-108	9721769, 175AA1	Lamp, 28V, #85
3	DB-21	171AG1, 9818443	Clear cap
4	DB-22	9851288, 129AB1	Bracket, mounting
5	DB-42	9893209, 130AA1	Target lens
6	DB-43	9822690, 128AB1	Bezel, BLACK, 1-1/4" x 1-1/4"
	DB-43A	9822707, 128AB2	Bezel, BLUE, 1-1/4" x 1-1/4"
	DB-25	9822719, 128AB3	Bezel, RED, 1-1/4" x 1-1/4"
	DB-44-		Spacer, 1.25", square, specify marking
7	DB-44-	9893933, 131AE5	Spacer, arrow Horizontal mount, for hall
	ARROW HALL		
	DB-44-	9719398, 138200	Spacer, arrow Vertical mount, for car
	ARROW CAR		
	DB-44-1	9798160	Spacer, 1.25" square, marked #1
	DB-44-8		Spacer, 1.25" SQ Marked #8
	DB-44-9		Spacer, 1.25" SQ Marked #9
	DB-44-10		Spacer, 1.25" SQ Marked #10
	DB-44-11		Spacer, 1.25" SQ Marked #11
	DB-44-12		Spacer, 1.25" SQ Marked #12
	DB-44-14		Spacer, 1.25" SQ Marked #14
	DB-44-STAR-1	9798158	Spacer, 1.25", square, marked "Star 1"
	DB-44-BLANK		Spacer, 1.25" square, blank
8	DKS-13, DKS-14		Key Switch (See "Key Switches", page 550 for complete listing)
9	DKS-24-		Bezel, Key switch, (See "Bezels", page 550 for complete listing)
10	DB-57	200AA1	Fastener, Faceplate 10-24 x 2 Button head screw
11	DB-23	140809	Clip, spring
12	DB-73	129BC1	Housing, for pushbutton
13	DB-74	232AA1	Housing, for micro switch
14	DB-75	228AF1	Actuator for pushbutton
15	DB-76	780AB1, 780AD1	Spring
16	DB-52	9772509, 770AE1	Lamp socket
17	DKS-58	131AF1	Spacer
	DHDW-002	9752018	Speed Nut, Signal Fixtures #10-24 "Emerg Exits"

Pushbutton Assemblies

Item	O.E.M. #	Description
DB-77A	9817219, 171AV1, 171AV4	Pushbutton assembly complete, with two micro switches, black bezel
DB-77A-LED-R		Pushbutton assembly, Red LED with 2 Micro Switches
DB-77A-LED-O		Pushbutton assembly, Orange LED with 2 Micro Switches
DB-77A-LED-G		Pushbutton assembly, Green LED with 2 Micro Switches
DB-77A-LED-W		Pushbutton assembly, White LED with 2 Micro Switches
DB-77A-LED-Y		Pushbutton assembly, Yellow LED with 2 Micro Switches
DB-77A-VAN-A	9817219-VANDAL	Pushbutton assembly, Vandal Proof with 2 Micro Switches, Alum Finish
DB-77A-VAN-B	9817219-VANDAL	Pushbutton assembly, Vandal Proof with 2 Micro Switches, Black Finish
DB-77A-VAN-B-BLED		Pushbutton assembly, Vandal Proof with 2 Micro Switches, Black Finish, Blue LED
DB-77A-VAN-B-RLED		Pushbutton assembly, Vandal Proof with 2 Micro Switches, Black Finish, Red LED Bulb
DB-77A-VAN-B-KIT		Vandal Upgrade Kit, Black Bezel with Retaining Brackets
DB-77A-VAN-R	9817219-VANDAL	Pushbutton assembly, Vandal Proof with 2 Micro Switches, Red Finish
DB-77A-VAN-R-KIT		Vandal Upgrade Kit, Red Bezel with Retaining Brackets
DB-77A-VAN-BLU	9817219-VANDAL	Pushbutton assembly, Vandal Proof with 2 Micro Switches, Blue Finish
DB-77A-VAN-BLU-KIT		Vandal Upgrade Kit, Blue Bezel with Retaining Brackets
ML-108-LED-W		Lamp, #85 LED White
ML-108-LED-O		Lamp, #85 LED Orange
ML-108-LED-R		Lamp, #85 LED Red
ML-108-LED-Y		Lamp, #85 LED Yellow
DB-77B	171AV2, 171AV5	Pushbutton assembly complete, same style as DB-77A but with BLUE bezel
DB-77C	171AV3	Pushbutton assembly complete, same style as DB-77A but with RED bezel
DB-77E		Pushbutton assembly complete, Old Style with 2 Micro-switches, small tabs
DB-77F	9817190	Pushbutton assembly complete, New Style with 1 Micro Switch



DB-77A

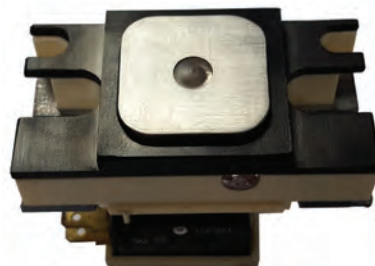

DB-77A-VAN-B



DB-77B



DB-77C

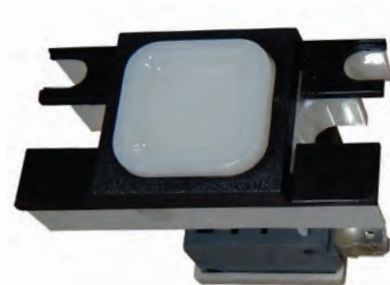

DB-77F

Car Signal Components

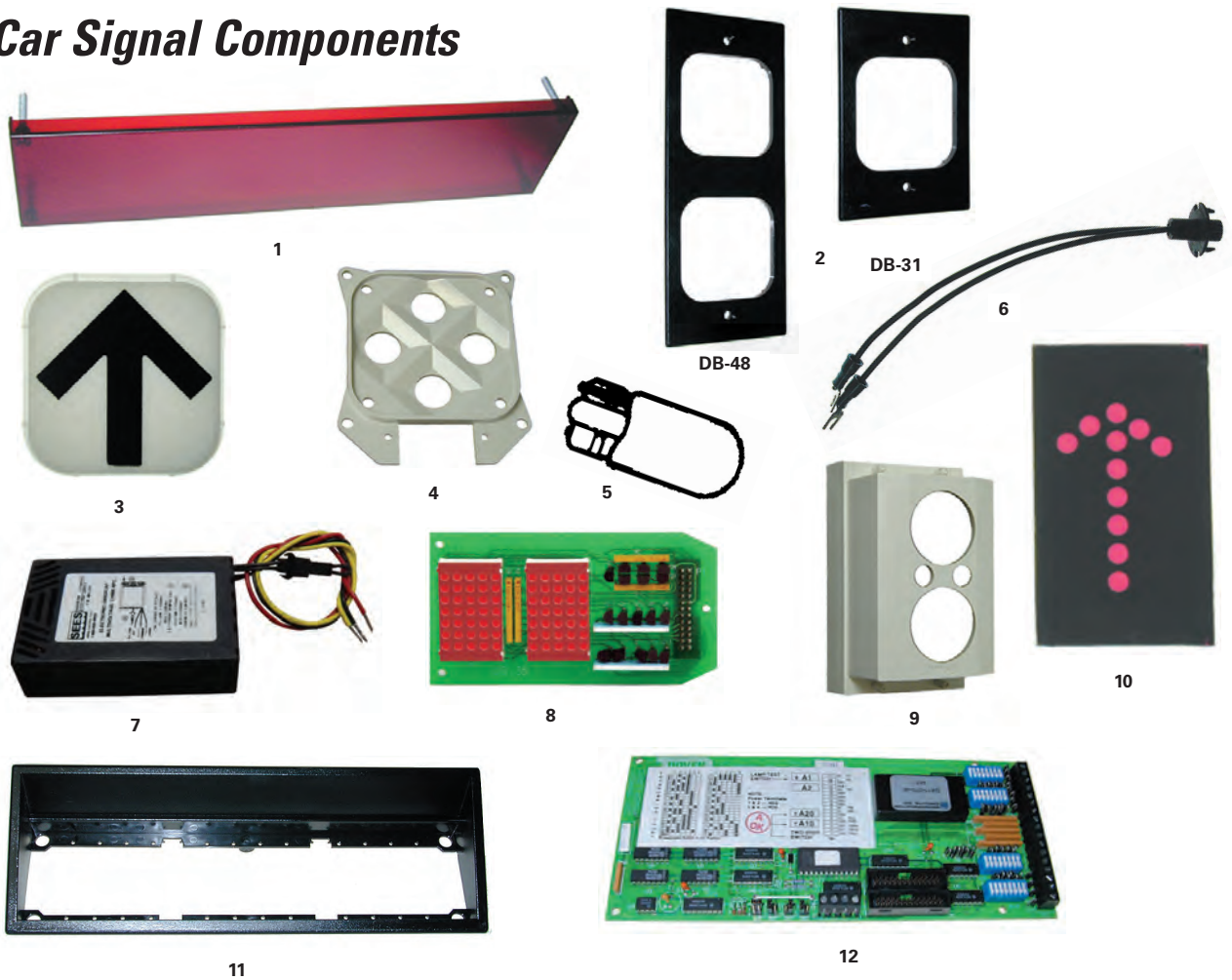

Hall Lantern and Position Indicator Assemblies

Item	S.E.E.S. #	O.E.M. #	Description
1	DB-30	9730618, 130AC2	Red Lens, 10" x 2-3/4", for position indicator
2	DB-31	9741215, 141AA1	Face Plate, 5" x 3-3/4", Jamb arrow frame, single
	DB-31-MF		Face Plate for Arrow, Mirrored Finish 6-3/4" x 5-1/4"
	DB-48	9741318, 141AA2	Face Plate, 9-1/4" x 3-3/4", Jamb arrow frame, double
	DB-48-MF		Frame, Jamb for Double Arrow, Mirrored Finish 10-3/4" x 5-1/4"
3	DB-32	9730266, 130AD2	Lantern Lens, arrow, 2-3/4" x 2-3/4" face, 3" square base
4	DB-33	134AD1, 9734144	Reflector, lantern lens
5	ML-108	9721769, 175AA1	Lamp, 28V
6	DB-29	9727152	Lamp Socket, Impulse lamp holder
7	MIS-CH1	9775717, 177A1	Chime, hall lantern, 24-130 VAC/DC. Non-polar
8	DB-35	9835878, 178AC1	PC Board, position indicator display board, dual
9	DB-36	134AA1	Reflector
10	DB-36A-	130AG1-24	Dot Film for discrete P. I., Specify marking, i.e. DB-36A-ARROW, 1.256" x 1.975"
11	DB-20	9832336, 138AA1, 138AA2	Inclined Housing
	DB-37	9713232, 178AD2	PC Board, Power board, logic, 24V
12	DB-38	9713244, 178AD1	PC Board, Power board, logic, 48V
	DB-CLS-001H		Car Lantern Assembly, Up Arrow - Red, Down Arrow - Green 28V Incandescent
	DB-CLS-002H		Car Lantern Assembly, (2) Arrows - Red 28V Incandescent

Car Signal Components

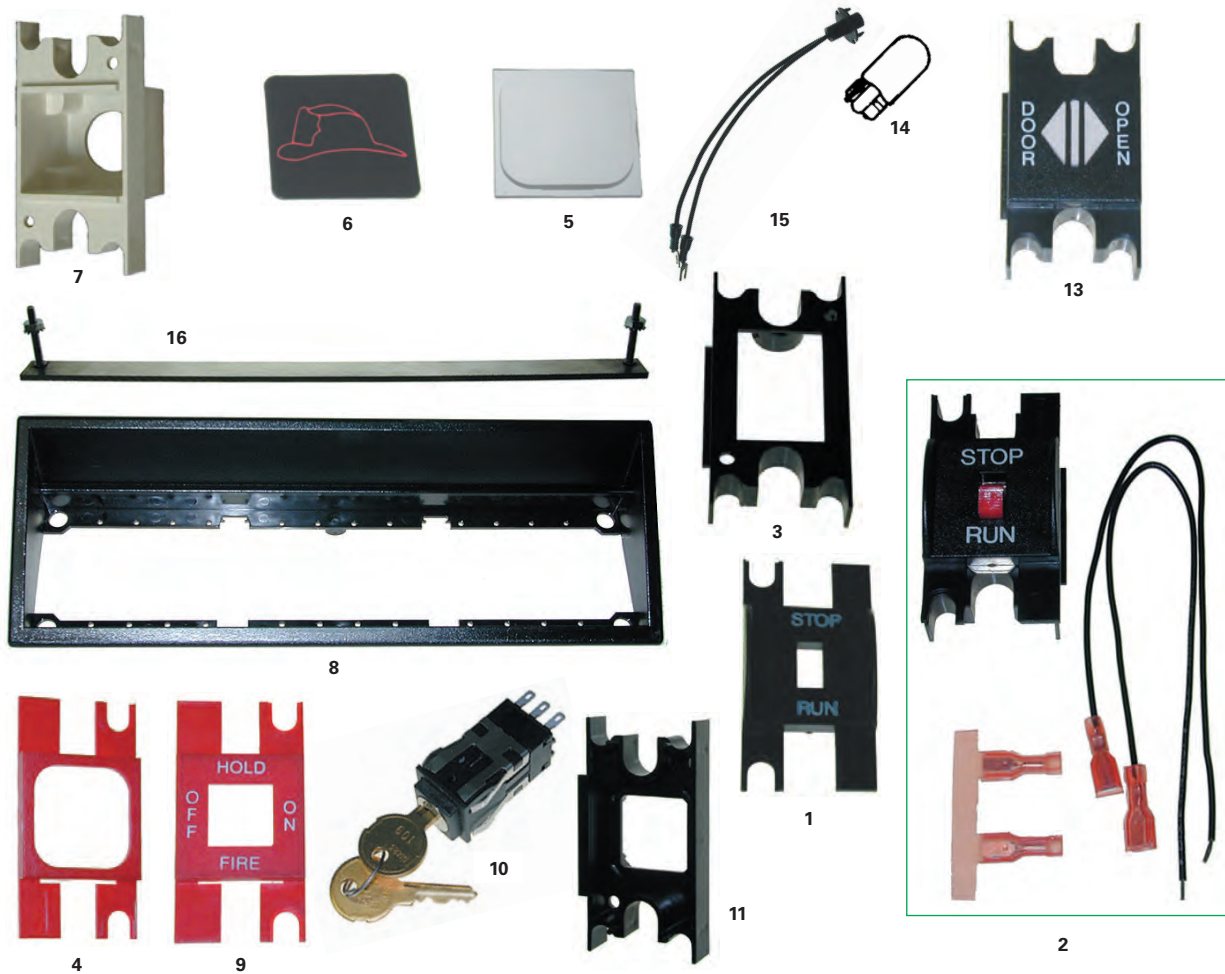

DOVER

Spacer, Fire Jewel and Switch Assemblies

Item	S.E.E.S. #	O.E.M. #	Description
1	DB-17 DB-17A	128AA2, 9728119 128AA3	Bezel, Run-Stop, face 1-1/4" x 1-1/4" Bezel, blank
2	DB-18	171AC2, 9810183, 9810158	Switch Assembly, DPST paddle switch, includes bezel
3	DB-19	129AA1	Mounting bracket
4	DB-25	128AB3, 9822719	Bezel, red, Fire Service
5	DB-26	130AB1	Lens, 1" square face, base 1.09" square, clear
6	DB-27A	130AF3	Lens, for Fire Service, with symbol of fire fighter's hat
7	DB-28	134AB1	Reflector
8	DB-20	138AA1, 138AA2	Inclined Housing
9	DKS-24-		Bezel, keyswitch (see listing next page for markings)
10	DKS-13, DKS-14		Key switch, (see listing next page)
11	DB-24	9851276, 129AC1	Bracket
13	DB-44-	132AE-	Spacer, 1.25" wide, black with white raised character with braille below specify marking, i.e. DB-44-OPEN (shown)
16	DB-70	129AF1	Hold Down Strip, Stainless, 10" L

Car Signal Components

Spacer, Fire Jewel and Switch Assemblies



DKS-13

Item	S.E.E.S. #	O.E.M. #	Description
	DB-44-FIRE-OPER	9805059, 131AE29	Spacer , Fire Fighter Operation
	DB-44-FIRE-INSERT	9805060, 131AE30	Spacer , "Insert Fire Key and Turn.."
14	ML-108	175AA1, 9721769	Lamp , 28V, #85
15	DB-29	138AD1, 9727152	Lamp housing
16	DB-70	129AF1	Hold down strip , stainless, 10" long

Key Switches

S.E.E.S. #	O.E.M. #	Key #	Description
DKS-13	171AA1, 9753140	5074, 109	2 Key positions , CTR, CW removeable key in both positions, suitable for PHOTO EYE, INDEP., EMERG. SVC., & LIGHT switches. ■ Switch is now furnished with 109 key
DKS-13A	9710279	5074	Key , replacement keys for "old style" switch
DKS-13B	9720091	109	Key , replacement keys for "new style" switch
DKS-14	171AA7	110	3 Key positions , CCW, CTR, CW key removable in CTR and CW positions, hall use, suitable for FIRE BYPASS. ■ Switch is now furnished with 110 key
DKS-14A	9710267	5027	Key , replacement keys for "old style" switch
DKS-14B		110	Key , replacement keys for "new style" switch
DKS-15A	9710255	5154	Key , replacement keys for "old style" switch
DKS-15B		107	Key , replacement keys for "new style" switch
DKS-16	171AA13	5027, 110	2 Key positions , CTR, CW key removable in both positions, suitable for EMERGENCY POWER. ■ Switch is now furnished with 110 key
DKS-18A	9710334	5140	Key , replacement keys for "old style" switch
DKS-18B	9720133	106	Key , replacement keys for "new style" switch
DKS-21	171AA2, 9753102	5140, 106	2 Key positions , CTR, CW key removable in CTR position only. INSPECTION. ■ Switch is now furnished with 110 key
DKS-25	9720133	H8020	Key

■ Bezel 1-1/4" square face with 5/8" x 5/8" square hole. Bezel markings are listed in the order that they appear, the first marking is at the 12 o'clock position, subsequent markings are in the 3 o'clock position, following clockwise to the next position (6) unless otherwise noted. i.e. see DKS-24-INDEPENDENT "Off" (12) "Serv" (3), "Indep" (9)

■ Additional markings available by Special Order.



DKS-24-INSPECTION

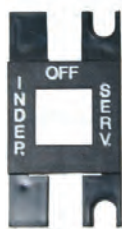

DKS-24-INDEPENDENT

Key Switch Bezels

S.E.E.S. #	O.E.M. #	Bezel Marking/Description
DKS-24-BLANK BLACK	128AC1	Bezel , blank, black
DKS-24-BLANK RED	128AC2	Bezel , blank, red
DKS-24-FIRE-BYPASS	128AC3	Off/On/Fire/Bypass , red bezel, hall use
DKS-24-FIRE-HOLD	128AC4	Hold/On/Fire/Off , red bezel, car use
DKS-24-INSPECTION	128AC5	Off/Insp , black bezel
DKS-24-INDEPENDENT	128AC6	Off/Serv/Indep (9) , black bezel
DKS-24-EMERGENCY	128AC7	Off/Serv/Emerg (9) , black bezel
DKS-24-OFF-ON	128AC11, 9822628	Off/On , black bezel for vertical car use
DKS-24A-OFF-ON	128AC12, 9822630	Off/On , black bezel for horizontal hall use
DKS-24-LIGHT	128AC13, 9822641	Light/Off , black bezel
DKS-24-LIGHT-FAN	128AC14, 9822653	Off/Fan/Light (9) , black bezel
DKS-24-HIGH-LOW-FAN	128AC15, 9822655	Off/High/Fan/Low , black bezel
DKS-24A-FIRE-BYPASS		Bezel , Red "Bypass-Off-On" Square, Horizontal

Car Signal Components

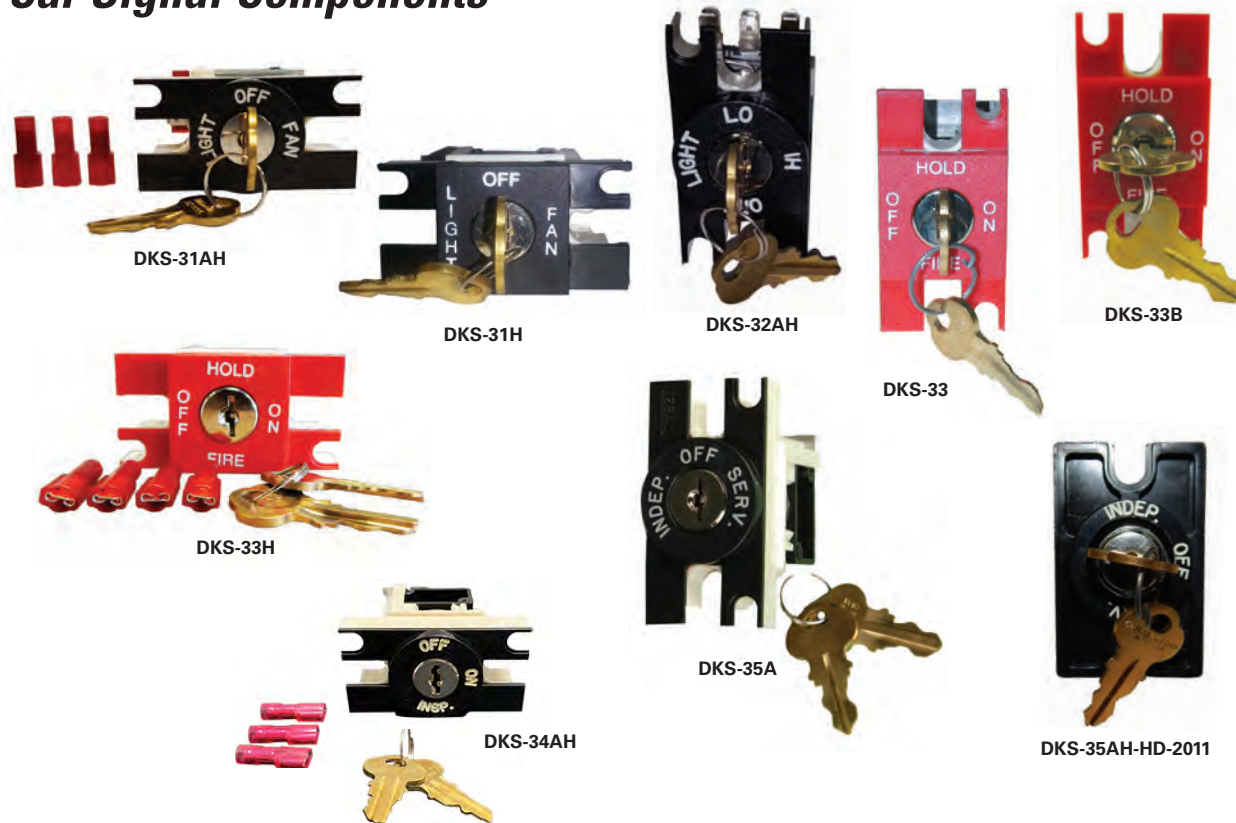

Key Switches

S.E.E.S. #	O.E.M. #	Key #	Marking/Description
DKS-30	9746006, 171AR1	H2395	Light/Off, 2 Position, Removable both, Vertical
DKS-30A		H2395	Key Switch Assembly, Light/Off, Round Vertical
DKS-30A-L203		L203	Key Switch Assembly, Light/Off L203, Round Black
DKS-31	9746018, 171AR2	H2395	Off/Fan/Light (9), 3 Position, Removable all, Vertical
DKS-31AH	9772935	H2395	Key Switch, Light/Fan, round, Horizontal
DKS-31AH-SEC		H2395	Key Switch, Sec-Off-Norm H2395 Round Black Horizontal, 3P, R3
DKS-31H		H2395	Key Switch, Light/Fan H2395 Square, Horizontal
DKS-32	9746020, 171AR3	H2395	Light/Lo/Hi/Off for Light and 2 Speed Fan, 4 Position, Removable all, Vertical
DKS-32H		H2395	KeySwitch, Light 2 Speed Fan, Square, Horizontal
DKS-32AH		H2395	KeySwitch, Light 2 Speed Fan, 4 Position, Round, Horizontal
DKS-33	9746031, 171AR4	H2389	Hold/On/Fire/Off for Car Fire Service, 3 Position, Removable all, Phase II, Vertical
DKS-33B		H2389	Key Switch Assembly, Car Fire Service, ON-ON-ON, Square Vertical
DKS-33BA		H2389	Key Switch Assembly, Car Fire Service, ON-ON-ON, Round, Vertical
DKS-33C		H2389	Key Switch, Fire Service PH2, Square Vertical, ON-ON-ON, 3 Pos Rmv2
DKS-33CA		H2389	Key Switch, Fire Service PH2, Round Vertical, ON-ON-ON, 3 Pos Rmv2
DKS-33H		H2389	Key Switch, Car Fire Service PH2, H2389, Square, Horizontal
DKS-34	9746043, 171AR5	H1846	Off/Inspection, 2 Position, Removable both, Vertical
DKS-34A		H1846	Key Switch Assembly, inspection, round
DKS-34AH		H1846	Key Switch Assembly, inspection H1846 Round, Horizontal
DKS-35	9746055, 171AR6	H2395	Off/Serv./Indep (9), 2 Position, Removable both, Vertical
DKS-35A		H2395	Key Switch, Independent Service, round, Vertical
DKS-35AH	9719775	H2395	Key Switch, Independent Service, round, Horizontal
DKS-35AH-HD		H2395	Key Switch, Independent Service, round, Horizontal, Heavy Duty
DKS-35AH-HD-2011		H2011	Key Switch, Independent Service H2011, Round, Horizontal, Heavy Duty, 2P2R
DKS-35AV-HD-2011		H2011	Key Switch, Independent Service H2011, Round, Vertical, Heavy Duty, 2P2R
DKS-35BV-HD-1848		H1848	Key Switch, Independent Service 1848 Sq, Vert, Heavy Duty, 2P2R

Key Switches

S.E.E.S. #	O.E.M. #	Key #	Marking/Description
DKS-36	9746067, 171AR7	H2395	Off/Eye/Photo (9), 2 Position, Removable both, Vertical
DKS-36AH		H2395	Key Switch, "Photo Eye", Round Horizontal
DKS-37	9746079, 171AR8	H2395	Off/Serv/Emergency (9), 2 Position, Removable both, Vertical
DKS-37H	9746079 Horiz	H2395	Keyswitch, "EMERG. SERVICE" Horizontal
DKS-38	9746080, 171AR9	H2395	Off/Hold/Door (9), 2 Position, Removable in Off only, Vertical
DKS-39	9746092, 171AR10	H1848	Off/On, for Car Call Lockout, 2 Position, Removable both, Vertical
DKS-39-HD		H1848	Key Switch, for Car Call Lockout, H1848
DKS-39-HD-L206		L206	Key Switch, Car Lockout L206 2P, R1 (Off/On), Heavy Duty, Vertical, Square
DKS-39-HD-#2		SEES #2	Key Switch, Car Call Lockout, SEES #2 Key 2P, 2KP (Off/On), Heavy Duty, Vet Sq
DKS-39-HD-#3		SEES #3	Key Switch, Car Call Lockout, SEES #3 Key 2P, 2KP (Off/On), Heavy Duty, Vet Sq
DKS-39A-HD		H1848	Key Switch, Car Call Lockout H1848 (Off/On) Heavy Duty, Vertical, Round
DKS-39-HD-A03		A03	Key Switch, Car Call Lockout, A03 Key (Off/On), Heavy Duty, Vertical, Square
DKS-41-HD-2395		H1846	Key Switch, Car Call Lockout H1846 (Off/On), Heavy Duty, Vertical Square
DKS-40	9746109, 171AR11	H1848	Off/On, for Car Call Register, 2 Position, Spring return, Vertical
DKS-40A		H1848	Key Switch, Car Call Register
DKS-40A-HD		H1848	Key Switch, Car Call Register Round, Vertical, Heavy Duty, H1848
DKS-40AH-HD		H1848	Key Switch, Car Call Register Round, Horizontal, Heavy Duty, H1848
DKS-40B-HD		H2395	Key Switch, Car Call Register Round, Vertical, Heavy Duty, H2395
DKS-40C-HD		H2395	Key Switch, Car Call Register Square, Vertical, Heavy Duty
DKS-40-HD-2011		2011	Key Switch, Off-On, 2 Pos Mom, Square, Black Vertical, Heavy Duty, 2011
DKS-41	9746110, 171AR12, 9739713	H1848	Off/On, for Hall Register, Terminal, 2 Position, Spring return, Horizontal
DKS-41A		H1848	Off/On, for Hall Register, Terminal, Round
DKS-41-DES1		DES-1	Key Switch, Term Hall Reg DES-1 Key
DKS-41A-DES1		DES-1	Key Switch, Term Hall Reg, Round Horizontal DES-1 Key
DKS-41-HD		H1848	Term Hall Reg. Square, Horizontal, Heavy Duty, 2 Position Mom
DKS-41-HD-1846		H1846	Key Switch, Term Hall Reg. Square, Horizontal
DKS-41-HD-2395		H2395	Key Switch, Off-On Square Horizontal Heavy Duty, H2395, 2 Position Mom
DKS-41A-HD		H1848	Term Hall Reg. Round, Horizontal, Heavy Duty, 2 Position Mom
DKS-41B-HD		H2395	Term Hall Reg. Round, Horizontal, Heavy Duty, 2 Position Mom
DKS-41C-HD		SEES#3	Key Switch, Term Hall Reg. Round, Horizontal, Heavy Duty, SEES#3, 2 Pos Mom
DKS-41V		H1848	Key Switch, Term Hall Reg H1848 Vertical, Square, Off-On
DKS-42	9746122, 171AR13	H1848	Off/Dn/Up (9), for Hall Reg., Intermediate, 3 Position, Spring return to Off, Horizontal
DKS-42V		H1848	Key Switch, Hall Reg. Intermediate Vertical
DKS-42-HD		H1848	Key Switch, Hall Reg Intermed 3 Position, MOM Horizontal, H1848 Heavy Duty
DKS-42A-HD		H1848	Key Switch, Hall Reg Intermed, Round Black 3Pos MOM Horiz, H1848 Hvy Duty
DKS-43	9746134, 171AR14	H1848	Off/On, for Hall Call Lockout, 2 Position, Removable both, Horizontal
DKS-43-HD	9746134-HD	H1848	Off/On, for Hall Call Lockout, Heavy Duty, 2 Position, 2KP, Horizontal
DKS-43A-HD		H1848	Keyswitch, Hall Lockout, Heavy Duty 2P, 2KP H1848 Key, Black Round Horiz
DKS-43-HD-1846		H1846	Keyswitch, Hall Lockout Off/On Heavy Duty, 2P/2KP, Horiz H1846
DKS-43-HDV-2395		H2395	Keyswitch, all Lockout Off/On Heavy Duty, 2P/2KP, Vert H2395
DKS-43A-HD-2395		H2395	Keyswitch, Hall Lockout Off/On Heavy Duty, 2P/2KP, Round, Horizontal, H2395



DKS-39-HD



DKS-40



DKS-40AH-HD



DKS-41



DKS-41-HD



DKS-41A-HD



DKS-41B-HD



DKS-40C-HD



DKS-42V

Key Switches

S.E.E.S. #	O.E.M. #	Key #	Marking/Description
DKS-44	9746146, 171AR15	H2395	On/Lobby (9) , 2 Position, Removable both, Horizontal
DKS-45	9746158, 171AR16	H2389	Off/Power/Emergency (9) , 2 Position, Removable both, Horizontal
DKS-46	9746160, 171AR17	H2389	Off/On/Fire/Byp. , for Hall Fire Service, PHI, 3 Position, Removable 2, Horizontal
DKS-46A		H2389	Key Switch , for Hall Fire Service, round
DKS-46B		H2389	Key Switch , Fire Service, Round, Horizontal, 2P/R2 H2389 Off-On
DKS-46C		H2389	Key Switch , Fire Service, Square, Vertical, 2P/R2 H2389 Off-On
DKS-46AR		H2389	Key Switch , Hall Fire Service, Round, Horizontal, Reset-Off-On
DKS-46R		H2389	Key Switch , Hall Fire Service, Square, Horizontal, Reset-Off-On
DKS-47	9746171, 171AR18	H1846	Off/Up/Hwy.Acc./Dn , 3 Position, Spring return to Off, Horizontal
DKS-47A		H1846	Key Switch , Hoistway Access, 48V, round
DKS-47A-2395		H2395	Key Switch , Rnd Black Hoistway Access Up-Off-Dn Hwy Access, 3Pos MOM
DKS-48	9746183, 171AR20	H2389	Off/On/Fire/Bypass , red, for Hall Fire Service, 3 Position, Removable 2, Vertical
DKS-48A		H2389	Key Switch , for Hall Fire Service, Vertical
DKS-48R		H2389	Key Switch , Fire Service PHI Vertical, Square, Reset-Off-On
DKS-48RA		H2389	Key Switch , Fire Service PHI Vertical, Round, Reset-Off-On
DKS-48-NY		3502	Key Switch , Fire Service PHI Vertical, Square, with 3502 Key
DKS-49	9746195, 171AR21	H1846	Stop/Run , for In Car Stop, 2 Position, Removable both, Vertical, (Square Bezel)
DKS-49A	138530, 9715952	H1846	Stop/Run , for In Car Stop, 2 Position, Removable both, Vertical, (Round Bezel)
DKS-49B	9735112	H2011	Key Switch , car Run/Stop 2 Position remove in both, Round, Vertical
DKS-49C		SEES#2	Key Switch , car Run/Stop 2Pos Remove 2, Square, Vertical
DKS-50	9746201, 171AR22	H1846	Off/Access , for In Car Access, 2 Position, Removable both, Vertical
DKS-50AH	H2395		Key Switch , In-Car Access Round Black Horizontal H2395, Off-Access
DKS-61	780ACI		Spring , return
DKS-74B	9845641	H1846	Cylinder Lock , H-1846, DKS-74 & DKS-74A
DKS-76	660AP1	H2011	Key plug for H2011 key Emergency Stop
DKS-78-LOCKOUT-SP			Key switch Special , 2 positions, Rmv2
DKS-79V		L206	Key Switch , Code Blue, Square Vertical Black, 2 Pos, Rmv1, (Off-Code Blue)
DKS-79H		L206	Key Switch , Code Blue, Square Horizontal Blk, 2Pos, Rmv1, (Off-Code Blue)
DKS-79AH		L206	Key Switch , Code Blue, Round Horizontal Black, 2 Position, R1, (Off-Code Blue)
DKS-80HR		H2395	Key Switch , Code Blue, Round Horizontal Black, 2 Position, R1, (Code-On-Blue)
DKS-100	9932057		Key Switch , Up and Down
DKS-200	9721757, 2174-2	2165	Cylinder , Key Switch 2174-2, E Lock, Removable 2
DKS-202	9776801		Key , for Fire Service #SC1000
DKS-203		H2389	Key switch , Fire Phase 1, 3 Position R2, Key H2389
DKS-204		H2389	Key switch , Fire Phase 2, 3 Position R2, Key H2389

- Bezel markings are listed in the order that they appear, the first marking is at the 12 o'clock position, subsequent markings are in the 3 o'clock position, following clockwise to the next position (6) unless otherwise noted. For examples, see DKS-31 "Off" (12) "Fan" (3), "Light" (9)
- Additional markings available by Special Order.



DO YOU KNOW FEO?

ASME A17.1 2007 AND UP 2.78.8 SWITCH KEYS

The key switches required by 2.27.2 through 2.27.5 for all elevators in a building shall be operable by the **FEO-K1 KEY**. The keys shall be Group 3 Security. A separate key shall be provided for each switch. These keys shall be kept on the premises in a location readily accessible to firefighters and emergency personnel...

...The key shall be coded "FEO-K1."



FEO-K1
ORDER YOUR
FIRE SERVICE
KEY TODAY!

FIRE SERVICE / FEO KEY SWITCH PARTS

SEES carries all elevator brands

FOR ALL
FEO PARTS SEE
PAGES 346-354
IN THE
SEES CATALOG

FEO-K1



UNIVERSAL



TRADITIONAL



IMPULSE



INNOVATION



DOVER



CYLINDER



GAL



ADAMS



KONE



SCHINDLER



OTIS



Always Smooth Sailing



@SEESinc



SEESinc.com/blogs



SEESinc



**SOUTHERN ELEVATOR
& ELECTRIC SUPPLY**

Car Signal Components

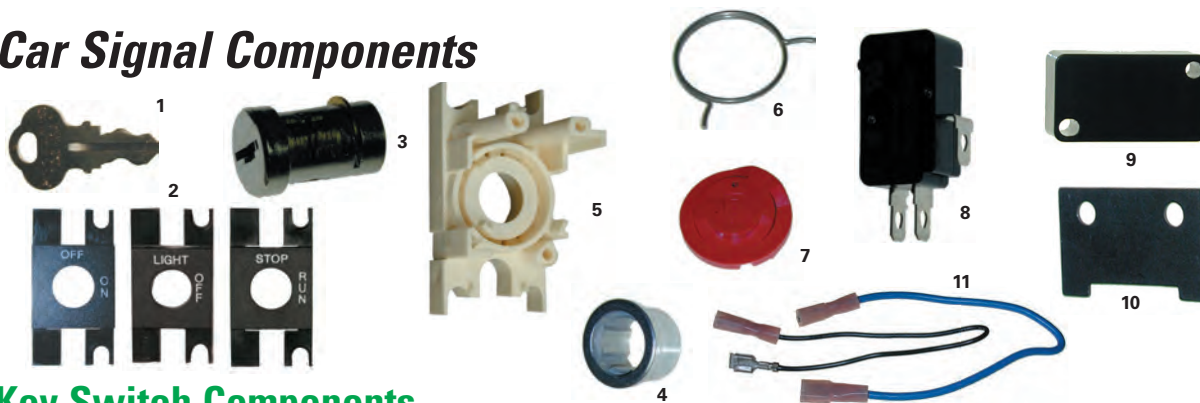

Key Switch Components

Item	S.E.E.S. #	O.E.M. #	Description
1	DKS-3A	9703135, 103105	Key , H2395
	DKS-4A	9703196, 103107	Key , H2389
	DKS-52A-	128AD-	Bezel , 1-1/4" Square face with 5/8" dia. hole, (specify marking & orientation)
	DKS-52B-	138174, 138485	Bezel , 1-1/4" diameter Round face with 5/8" dia. hole (specify marking & orientation)
	DKS-52BA-		Bezel , Round, Black, Horizontal, Specify Markings i.e. DKS-52BA-ACC, shown
	DKS-52BA-SPECIAL		Bezel , Round, Black, Horizontal, special marking
	DKS-52BA-ACC		Bezel , Off-On Hwy Acc, Round Black Horizontal Mt
2	DKS-52-	128AD-	Bezel , 1-1/4" Square face with 5/8" dia. hole, shown (specify marking & orientation)
4	DKS-53	662AA1	Lock , Barrel
	DKS-54	638AC1	Pin , 1/16" x 1/2"
5	DKS-55	129AY1	Bracket , mounting
7	DKS-56	228AA1	Cam for keyswitch , Black
	DKS-56A	228AA2	Cam for keyswitch , Clear
	DKS-56B	228AA3	Cam for keyswitch , White
	DKS-56C	228AA4	Cam for keyswitch , Red
8	DKS-57A	171AP1, 9818431	Micro Switch , 100 Gram pressure sensitivity
9	DKS-58	131AF1	Spacer
	DKS-58A	638AA1	Pin , key switch connector
10	DKS-59	711AA1	Retainer
	DKS-60	780AB1	Spring , detent, for keyswitch
6	DKS-61	780AC1	Spring , return
11	DKS-62	900AB14	Jumper , 7", 2 wire
	DKS-63	900AD36	Jumper , 6", 1 wire
3	DKS-72	660AC1	Plug , Key, 1 slot, H2389 key
	DKS-73	660AC2	Plug , Key, 1 slot, H2395 key
	DKS-74	660AD1, 9845641	Plug , Key, 2 slot, H1846 key
	DKS-75	660AD2	Plug , Key, 2 slot, H1848 key
	DKS-76	660AP1	Plug , Key, 2 slot, H2011 key
	DKS-74A	9731064, 103106	Key , H1846
	DKS-74B	9845641	Cylinder Lock , H-1846, DKS-74 & DKS-74A
	DKS-75A	9703391, 148008	Key , H1848



DKS-52A-OFF-ON



DKS-52B-BLANK BLACK



DKS-52B-BLANK RED



DKS-52BA-ACC



DKS-54



DKS-60

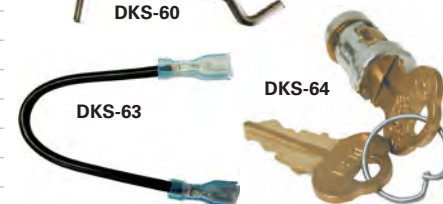

DKS-63

DKS-64

S.E.E.S. #	O.E.M. #	Description
DKS-64	9738605	Cylinder DES-1 key
DKS-64A	9718308	DES-1 key
DKS-65	9738629	Cylinder DES-3 key
DKS-65A	9718321	DES-3 key
DKS-66	9738630	Cylinder DES-4 key
DKS-66A	9718333	DES-4 key
DKS-67	9738642	Cylinder DES-5 key
DKS-67A	9718345	DES-5 key

S.E.E.S. #	O.E.M. #	Description
DKS-68	9738654	Cylinder DES-6 key
DKS-68A	9718357	DES-6 key
DKS-69	9738666	Cylinder DES-7 key
DKS-69A	9718369	DES-7 key
DKS-70	9738680	Cylinder DES-9 key
DKS-70A	9718382	DES-9 key
DKS-71	9738691	Cylinder DES-10 key
DKS-71A	9718394	DES-10 key

Car Signal Components



1



DB-41-2100



DB-39

2

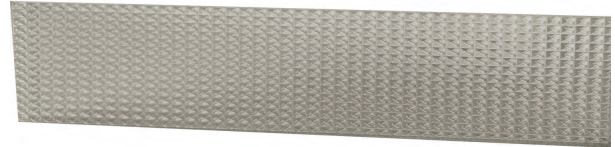

DB-90



3



5

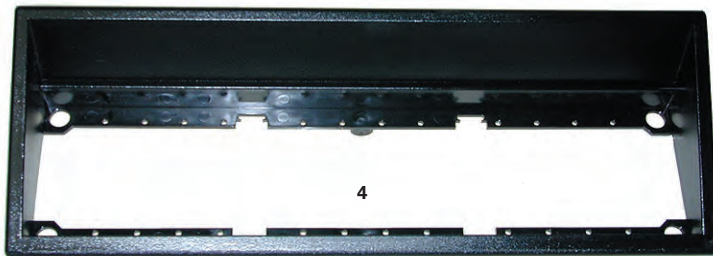

4



6

Emergency Light Components

Item	S.E.E.S. #	O.E.M. #	Description
1	DB-41	169AC12, 163AC24	Plate, blank, 10" x 2.44"
	DB-41-2000		Plate, 2000lb capacity lens
	DB-41-2100	9896820	Plate, 2100lb capacity lens
	DB-41-3000		Plate, 3000lb capacity lens
	DB-41-3500		Plate, 3500lb capacity lens
	DB-41-4500	9896879	Plate, 4500lb capacity lens
2	DB-39	130AC1	Clear lens, 10" x 2-3/4", for emergency light assembly
	DB-90	130AP1	Lens, old style Dover emergency light
3	DB-12	134AE1, 9872097	Reflector
4	DB-20	138AA1, 9832336	Inclined housing
5	DPC-37	118412, 9818420	PC board, emergency light printed circuit board, LED version
5	DPC-37A	9839720, 6300GD1	PC board, emergency light printed circuit board, new version to replace DPC-37
	ML-31	108248, 9782485	Lamp, 5.1V
6	DB-52B		Lamp holder
	MIS-194B	9880719	Battery, 7AH, 6V, replacement for emergency light



DB-49



DB-49B



DB-49C

S.E.E.S. #	O.E.M. #	Description
DB-49	168AA2, 9768117	Frame for telephone box, 10-1/2" W x 12-3/8" H
DB-49B	9846384, 168AA1	Handle for telephone box cover, black plastic handle, phone shaped for Braille use, 1-1/8" c/c mounting holes, 1.575" long
DB-49C	9766212	Magnetic Catch for phone box door
DB-49D	173AF2	Door , Stainless steel phone cabinet door, 10-1/2" x 12-1/2"
DB-50	9710619	Phone Jack Module , red, square, fire service
DB-50A		Phone Jack , red, round, horizontal, fire service
DB-50AV		Phone Jack , red, round, vertical, fire service
DB-50V	9710681	Phone Jack , red, square, vertical, fire service
DB-51	9885822	Phone Jack Module , fireman telephone for DB-50/50A
DB-60	169AV1, 9769249	Braille sheet consisting of an assortment of plastic self adhesive braille plates
MIS-T-100		Telephone box , stainless steel cover, 10" x 12.5", box 9" x 10.625"
MIS-TH-100		Replacement handle , for telephone box, aluminum, "PHONE"
MIS-TH-100-P	9846396	Replacement handle , for telephone box, plastic, "PHONE"



DB-49D



DB-50



DB-50A



DB-60



MIS-T-100



MIS-TH-100



MIS-TH-100-P



S.H.E. IS A 10

1. Machine RoomLess Elevator
2. Smooth ride counter-weighted traction equipment
3. No hydraulic oil
4. VVVF Drive
5. Standard LED lighting
6. Car Operating Panel with Emergency Light and Phone
7. Real Wood cab
8. 950 lb. capacity
9. 40 feet per minute
10. Made in the USA

CALL US : 800-526-0026



CUSTOMIZE

Choose from a wide range of features and options including wood types, handrails, light fixtures and cab styles. SEES will work with you to bring your vision to life.



MACHINE ROOM-LESS

No hydraulic cylinder, machine room or hydraulic oil. Instead, S.H.E. uses a small electric motor which fits within the hoistway overhead.



ENERGY SAVINGS

Thanks to the efficient motor and traction equipment, S.H.E. energy savings are estimated at 70-80% compared to hydraulic elevators.

WHY A SEES HOME ELEVATOR?

All SEES Home Elevators come with the SEEScreen Electronic Door Detector, designed to ensure maximum passenger safety. The SEEScreen's 94 infrared beams act as an invisible safety curtain across the door entrance. When an obstacle breaks the screen, the sensors detect it and immediately stop the elevator to avoid any accidents.



CONVENIENCE

S.H.E. improves in-home mobility and gives you the freedom to safely access any floor with ease.



INVESTMENT

S.H.E. is a sound investment and will increase your home's value and expand its marketability.

CONTACT US

By Phone:
800.526.0026
954.971.1115

By Fax:
954.917.7337
Visit Us: www.SEESinc.com



FLEXIBILITY

Purchase the S.H.E. with or without the cab. SEES will work with you to design and build exactly what you want.



MADE IN THE U.S.A.

S.H.E. is constructed from the finest materials at the SEES Modernization Center in Fort Lauderdale.



Car Signal Components

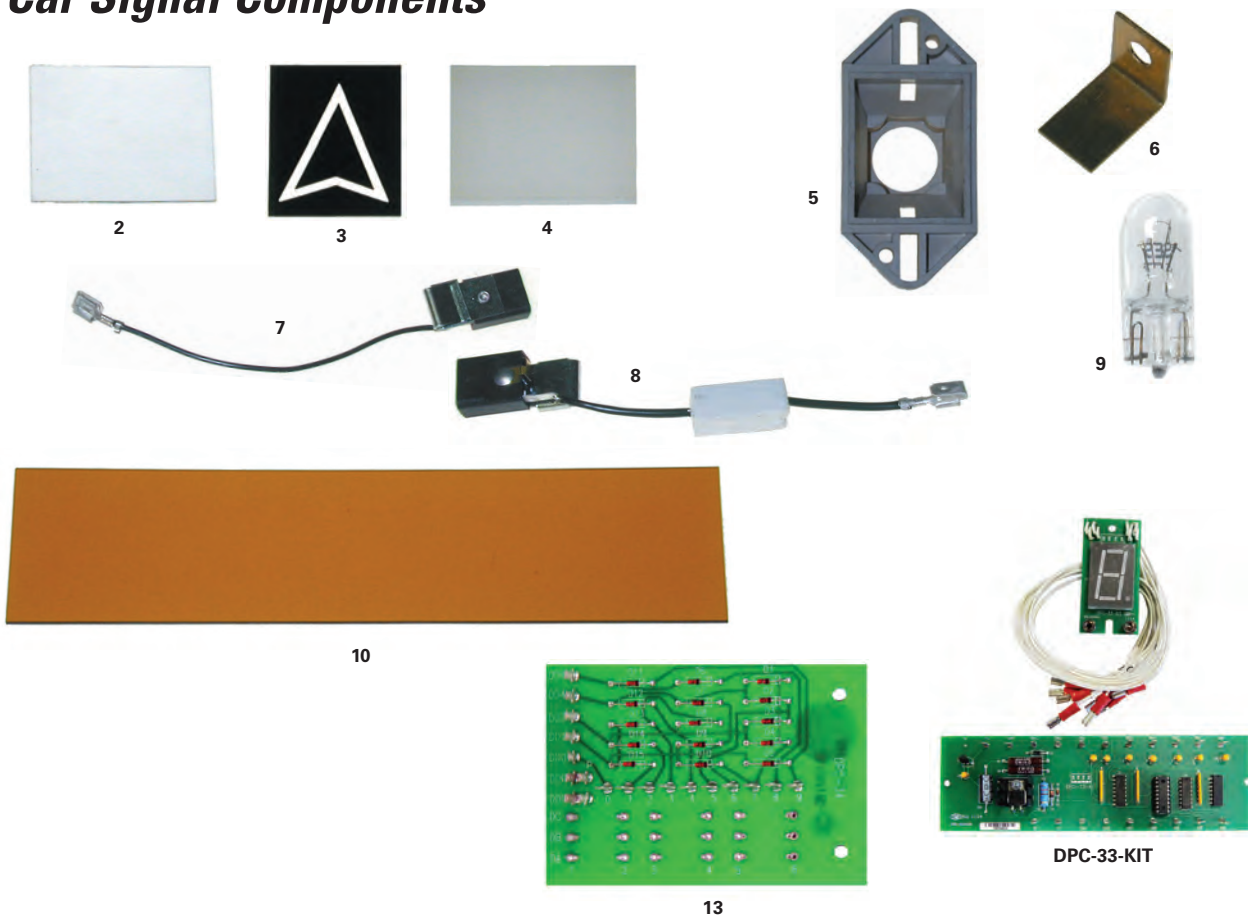

DOVER

Digital Position Indicator

Item	S.E.E.S. #	O.E.M. #	Description
2	DB-62	9714212, 114205	Reflector lens, 1.03" x 1.28", for digital position indicator
3	DB-67-	114212	Discrete film, 1-1/4" x 1", specify marking, i.e. DB-67-ARROW
4	DB-63	9714200, 114204	Reflector diffuser for digital position indicator
5	DB-64	114202, 9753746	Reflector for lamp for digital position indicator
6	DB-65	107184	Clip for digital position indicator assembly
7	DB-52D	9727164, 107186	Lamp holder assembly, for 24V position indicator assembly
8	DB-52C	9778174, 112639, 9712630	Lamp holder assembly, with resistor, for 48V position indicator
9	ML-57	9727190, 107189	Lamp, #657, 28V wedge base
	DB-67-6		Discrete Film, "6" for digital position indicator
10	DB-68	9844284, 114284	Amber lens, 6-1/2" x 1-9/16", for digital position indicator
	DB-56	9880239	Lens, 5-1/2" x 1-9/16", red, for digital position indicator
	DB-68A	9830595	Red lens, 6-1/2" x 1-9/16", for digital position indicator
	DPC-32B		P.C. Board, LED Driver Board Replaces Old DPC-32
	DPC-33-KIT		PCB & PI Led Display, DPC-32B, DPC-33A
	DPC-33A		P.C. Board, PI LED Display Replaces DPC-33 / Plasma
13	DPC-34	1133323, 9813378, 9813366	P.C. Board, decoder printed circuit board assembly 0-9, L & P
	DPC-18A	9830595	P.C. Board, PI interface

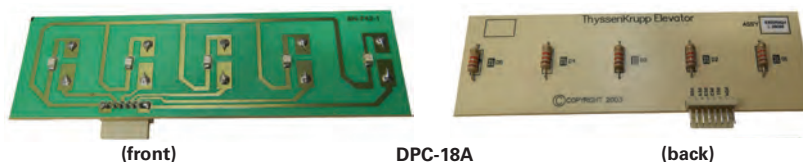

(front)

DPC-18A

(back)

Car Signal Components



Gongs and Buzzers

S.E.E.S. #	O.E.M. #	Description
DB-71	9871937, 107193	Gong assembly, 24 VDC, brass single stroke gong with mounting bracket
DB-71A	9737194, 107191, 9711818	Gong, 24 VDC, brass single stroke gong alone
DB-72	9871925, 107924	Gong assembly, 48 VDC, brass single stroke gong with mounting bracket
DB-72A	9751580, 9711820, 9737170	Gong, 48 VDC, brass single stroke gong alone
DB-72B	9724394, 32429	Gong, 120 VAC, single stroke gong
DB-72C	9882765	Buzzer, 24-130 VDC
DB-72D	9882753	Buzzer, 24-48 VDC
DB-72E	9726603	Buzzer, 120 VAC
CYB-382-S	9830169	Handicap tone alarm, 10-48 VDC
DB-72K		Handicap tone alarm, 3-28 VDC, 85d.b. 3.5kh range
DB-200	9727413	Gong Assembly, Single Stroke, Lantern, Includes brackets, brass
DB-201	9882777	Buzzer, 24V, Fire Service, TAC

Belts

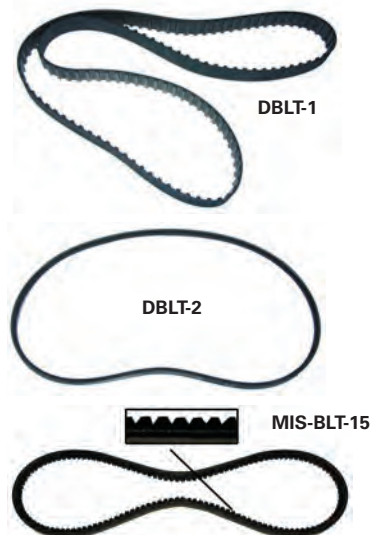

S.E.E.S. #	O.E.M. #	Description
DBLT-1	9749524, 77021	Timing belt, 48" x 1", 128 teeth, 48 arc, 3/8 pitch

S.E.E.S. #	O.E.M. #	Belt #	"V" Belt Dimensions
DBLT-2	9749512, 77018	1410, 3L410	41" x 3/8"
DBLT-3	9749152	1420, 3L420	42" x 3/8"
DBLT-7		1500	50" x 3/8"
DBLT-5		2500	50" x 1/2"
MIS-BLT9	9729756, 701975	3VX400	40" x 3/8"
MIS-BLT10	9729756	3VX425	42.5" x 3/8"
MIS-BLT11	9735252, 103515	3VX450	45" x 3/8"
MIS-BLT12	9749548	3VX475	47.5" x 3/8"
MIS-BLT13	9749433, 9772777	3VX500	50" x 3/8"
MIS-BLT14	9749550	3VX530	53" x 3/8"
MIS-BLT15	9749494, 77918	3VX560	56" x 3/8"
MIS-BLT16	9749408, 77919	3VX600	60" x 3/8"
MIS-BLT17	9749470, 77920	3VX630	63" x 3/8"
MIS-BLT17A	9749470	3V630	63" x 3/8"
MIS-BLT18	9749410, 77921	3VX670	67" x 3/8"

Brushes and Brush Holders



DBH-1



DBH-1A



DBH-2

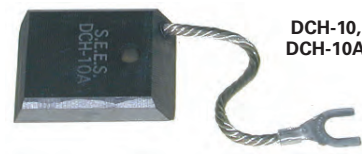

DCH-10,
DCH-10A



DCH-11A,
DCH-16



DCH-17, DCH-18



DCH-19



DCH-11



DCH-14



DCH-20



DCH-1



DCB-200



DCH-2



DCH-3



DCH-4

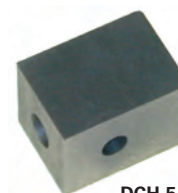

DCH-5

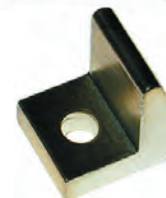

DCH-9

S.E.E.S. #	O.E.M. #	Description
DBH-1	9715307, 9745129	Brush holder for brushes DCH-10 and DCH-10A, .940 hole
DBH-1A	9745142	Spring clip for holder DBH-1
DBH-2	9717341	Brush Holder , for DCH-11A brush
DCH-10	9713888, 21388	Carbon brush , 1/2" x 1-1/2" x 2", bevel; shunt end 30 degrees, bottom 15 degrees
DCH-10A	9711533, 115316	Graphite brush , 1/2" x 1-1/2" x 2", bevel; shunt end 30 degrees, bottom 15 degrees
DCH-11A	9776898	Carbon brush , 5/16" x 1-1/4" x 2", top unbeveled, bottom bevel 15 degrees
DCH-12		Shunt , 12 3/4" Long
DCH-16	9711752	Carbon brush , 5/16" x 1-1/4" x 2", top bevel 30 degrees, bottom bevel 20 degrees, shunt 3-1/2"
DCH-17		Carbon brush , 3/8" x 1/4" x 7/8" replacement brush for SEES DDO-31 motor
DCH-18		Carbon brush , 5/16" x 5/8" x 1" replacement brush for SEES DDO-31E motor and Magnetek
DCH-19		Motor Brush , for 9801704 (DDO-31E Current Model), .375" W x .260" Th x .650" L
DCH-19A		Motor Brush , For 9801704, Set of 2.375" W x .260" Th x .650" L
DCH-20	9819447	Brush , 1/2" x 1-1/2" x 2"
DCH-11	9743601	Carbon brush , 3/8" x 1-1/4" x 2", bevel; shunt end 30 degrees, bottom 15 degrees
DCH-13	9743674	Carbon brush , 3/8" x 1" x 2", bevel; shunt end 30 degrees, bottom 15 degrees
DCH-14		Motor brush , 1/4" x 3/8" x 1", bevel; shunt end 15 degrees, bottom unbeveled
DCB-200	9710565	Brush , Door Motor Reliance Model M

Carbon Holders and Contacts

S.E.E.S. #	O.E.M. #	Description
DCH-1	9828229	Carbon holder , stem 4-3/4" L with 1/4 - 20 thread, overall 6" L
DCH-2	9770719	Carbon contact , 1/2" diameter x 3/4" L
DCH-3	9792910	Copper contact , 1/2" diameter x 3/4" L, silver face
DCH-4	9828175, 62817	Carbon holder , stem 5" L with 5/16- 24 thread, overall 6" L
DCH-5	9770800	Carbon contact , 1" x 1" x 1-3/8"
DCH-6	9828084, 62808	Carbon holder , stem 6" L with 3/8" - 16 thread, overall 7-1/2" L
DCH-7	9771189	Carbon contact , 1-1/2" x 1-1/2" x 1-1/2"
DCH-15	9740867	Carbon contact , 1-3/16" x 1" x 1-1/8"
DCH-9	9820565	Copper contact , silver plated with 1" x 1-1/4" face

Contacts



DC-1



DC-3



DC-4



DC-5



DC-6



DC-7



DC-2



DC-1A



DC-1C



DC-1S

S.E.E.S. #	O.E.M. #	Description
DC-1	9828205	Contact , shank 1/2" x 2-1/4" with 1/2" diameter copper tip
DC-1A	26992	Post , spring, with Cotter Pin
DC-1C	26993, 9769936	Cup , washer for post DC-1A
DC-1S	26994, 9769948	Spring , contact for post DC-1A
DC-2	9792909	Contact , shank 1/2" x 2-1/4" with 1/2" diameter silver tip
DC-3	9820589	Copper contact , 2-3/8" L x 5/8" W, with 9/32" diameter hole
DC-4	9820607	Copper contact , 2-3/8" L x 5/8" W, with 3/8" silver tip
DC-5	9810840	Copper contact , 1-15/16" L x 1/2" W, with 7/32" diameter hole
DC-6	9821284	Copper contact , 1-15/16" L x 1/2" W, with 3/8" diameter silver tip
DC-7	9828096, 1352	Contact with shank, 3/4" x 4-1/4", with 1-1/2" x 1-1/2" x 5/16" copper face. For 9771189 stationary contact
DC-8	9828217, 1350	Contact with shank, 5/8" x 3-1/4", with 1" x 1" x 1/4" copper face. For 9770800 and 9820565 stationary contact



DC-9

Threaded contact studs

S.E.E.S. #	O.E.M. #	Description
DC-9	9821302	Contact stud , threaded brass, 3/8" diameter silver tip, 3-7/8" L
DC-10	9821727, 60922	Contact stud , threaded brass, 1/4" diameter silver tip, 2-3/16" L
DC-11	9821739, 60923	Contact stud , threaded brass, 1/4" diameter silver tip, 2-15/16" L
DC-12	9821405	Contact stud , threaded brass, 1/4" diameter silver tip, 3-11/16" L



DC-13



DC-14

Contacts for 66089 Limit Switch

S.E.E.S. #	O.E.M. #	Description
DC-13	9861336, 66133	Stationary contact with silver tip
DC-14	9761585, 66158	Movable contact with silver tip

Contacts



CKF-1



CKF-3



CKF-5



CKF-8



CKF-10



CKF-11



CKF-12



CKF-13



CKF-14



CKF-16



CKF-15

Contact Kits

S.E.E.S. #	Contactor #	Contact Kit #	Description
CKF-1	9755330, 75533	9788785, 9755536 75553, 9790111	Size 2 Contact Kit , Furnas 75FB14A for "old style" vertical 75563 contactor
CKF-2	9755548, 75554	9755810, 35581	Size 2-1/2 Contact Kit , Furnas 75GB14 for vertical contactor
CKF-3	9755354, 75535, 75555, 75565	9755822, 35582, 9790238	Size 3 Contact Kit , Furnas 75HB14 for vertical contactor
CKF-4	9755366, 75536, 75556, 75566	9755834, 35583, 9790263	Size 3-1/2 Contact Kit , Furnas 75IB14 for Model B "old style" vertical contactor
CKF-5	9755378, 75537, 75557, 75567	9755834, 35583, 9790287	Size 4 Contact Kit , Furnas 75JB14 for Model B "old style" vertical contactor
CKF-8	9755317, 75531	9755792, 9790081, 35579, 75551, 75561	Size 1 Contact Kit , Furnas 75DF14 for "old style" vertical contactor
CKF-10	112194	9788748, 9790135	Size 2 Contact Kit , Furnas 75FF14 for 45 degree green contactor
CKF-11	9754714, 9713384	9790160	Size 2 Contact Kit , Furnas 75FP14 for 45 degree grey contactor
CKF-11A		75FP14	Size 2 Contact Kit , Furnas Size 2 #75FP14, Silver Contact
CKF-12	9755640, 75564	9790196	Size 2-1/2 Contact Kit , Furnas 75GF14 for 45 degree contactor
CKF-13	9755342, 75534	9790226	Size 2-1/2 Contact Kit , Furnas 75GP14 for 45 degree contactor
CKF-14	9755433, 9713396, 9818194	9790240	Size 3 Contact Kit , Furnas 75HF14. Starter goes in on a 45 degree angle
CKF-16	9790251	9790251	Size 3 (75A) Contact Kit , Furnas 75HF15 for vertical contactor
CKF-15	9755445	9790275	Size 3-1/2 Contact Kit , Furnas 75IF14 for Model B "old style" vertical contactor

Contacts



DCK-2

DCK-3



DC-15



DC-16



DC-17



DC-18



DC-20



DRP-20

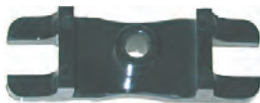

DRP-20I



DCM-001

Contact Kits

S.E.E.S. #	Contact #	Description
DCK-1	9955045	Auxiliary Contact, Furnas 49D54682N0
DCK-2	9790317	1 Pole Contact Kit, Furnas 75NB41
DCK-3	9790123	1 Pole Contact Kit, Furnas 75FE42

Contacts for DC Contactors "14 and 15" Switches

S.E.E.S. #	O.E.M. #	Description
DC-15	9759001	Stationary contact, normally closed
DC-16	9758902	Movable contact
DC-17	9759098	Stationary contact, normally open
DC-18	9758872	Spring, contactor, 8 turns
DC-19	9758884	Spring, contactor, 6 turns
DC-20		Spring, contactor, 6 turns, conical
DRP-20	9871184, 77118	Contact, 48 VDC coil, Single pole, double throw, make before break contacts, for #15 Switch
DRP-20A	9871196, 77117	Contact, 48 VDC coil, Single pole, double break contacts, for #14 Switch
DRP-20I	10074	Cradle block, contact guide for movable contact
DCM-001	9723596	Mount, Contactor Isolation 8-34" x 3/8" Long 2 Studs

Capacitors



DCAP-1



DCAP-2



DCAP-11



DCAP-7



DCAP-4



DCAP-9



DCAP-200



DCAP-201

S.E.E.S. #	O.E.M. #	Description
DCAP-1	9778044	Capacitor, 780 MFD, 250 VDC
DCAP-2	9779334, 77933	Capacitor, 4600 MFD, 25 VDC
DCAP-3		Capacitor, 270-324 MFD, 125 VAC
DCAP-4	9886667	Capacitor, 1 MFD, 600 VDC
DCAP-5	9768439	Capacitor, 2700 MFD, 40 VDC
DCAP-6	9764185, 76418	Capacitor, 1500 MFD, 50 VDC
DCAP-7	9763302, 76330	Capacitor, 500 MFD, 150 VDC
DCAP-8	9757600, 75760	Capacitor, 525 MFD, 300 VDC
DCAP-9	9755196	Capacitor, 2000 MFD, 450 VDC
DCAP-10	9713888	Capacitor, Dover, 440 VAC, 60mf, used On Tac-20 / 3 Per Motor
DCAP-11	9716865	Capacitor, 2800 MFD, 450 VDC
DCAP-12	9741379	Capacitor, Electrolytic 1300mf 50V CGS, Screw Caps
DCAP-200	238AD1	Capacitor, 90 MFD, 500 VDC/240 VAC
DCAP-201	9856250	Capacitor, 250 MFD, 50V with T Pins
DCAP-202		Capacitor, 100 MFD, 50V with T Pins

Coils

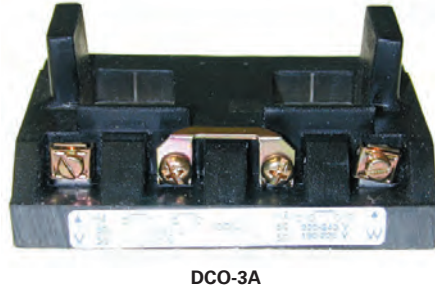

DC Contactor Coils 230V

S.E.E.S. #	O.E.M. #	Description	I.D.	O.D.	Length
DCO-1	9770124, 27012	1932 Ohm average	1-1/4"	2-3/4"	3"
DCO-2	9769870, 26987	462 Ohm average	1-5/16"	2-3/4"	2-7/8"

Starter Coils

S.E.E.S. #	O.E.M. #	Description
DCO-3A	9755469	Dual voltage coil, 110V/220V for starter sizes 3 - 3-1/2
DCO-3B	9788761	Dual voltage coil, 110V/220V for starter sizes 0 - 2-1/2

Coil 48VDC used on #14 and #15 switches

S.E.E.S. #	O.E.M. #	I.D.	O.D.	Length
DCO-4	9758940	1"	2"	2"

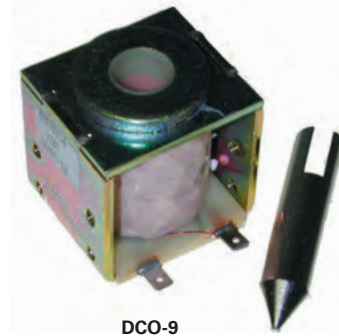

I-2 Valve Coils

S.E.E.S. #	O.E.M. #	Voltage	I.D.	O.D.	Length
DCO-5	9722300	120 VAC	1/2"	1-1/4"	1-1/4"
DCO-5B	9731659	220/230 VAC		1-1/2"	1-1/2"

Brake Coils

S.E.E.S. #	O.E.M. #	Description
DCO-7	9742440, 26326	Brake coil, 220 VDC, 395 Ohm, 3" I.D., 5.5" O.D., 5.45" L
DCO-8	9742463, 26327	Brake coil, 140 VDC, 170 Ohm
DCO-10	9742463, 26327	Inductor coil, with spade lugs

Solenoid Coil for Selector

S.E.E.S. #	O.E.M. #	Description
DCO-9	9869918, 76991	Solenoid coil, 24 VDC, for selector, coil .510" I.D., plunger .5" dia



Door Parts and Equipment

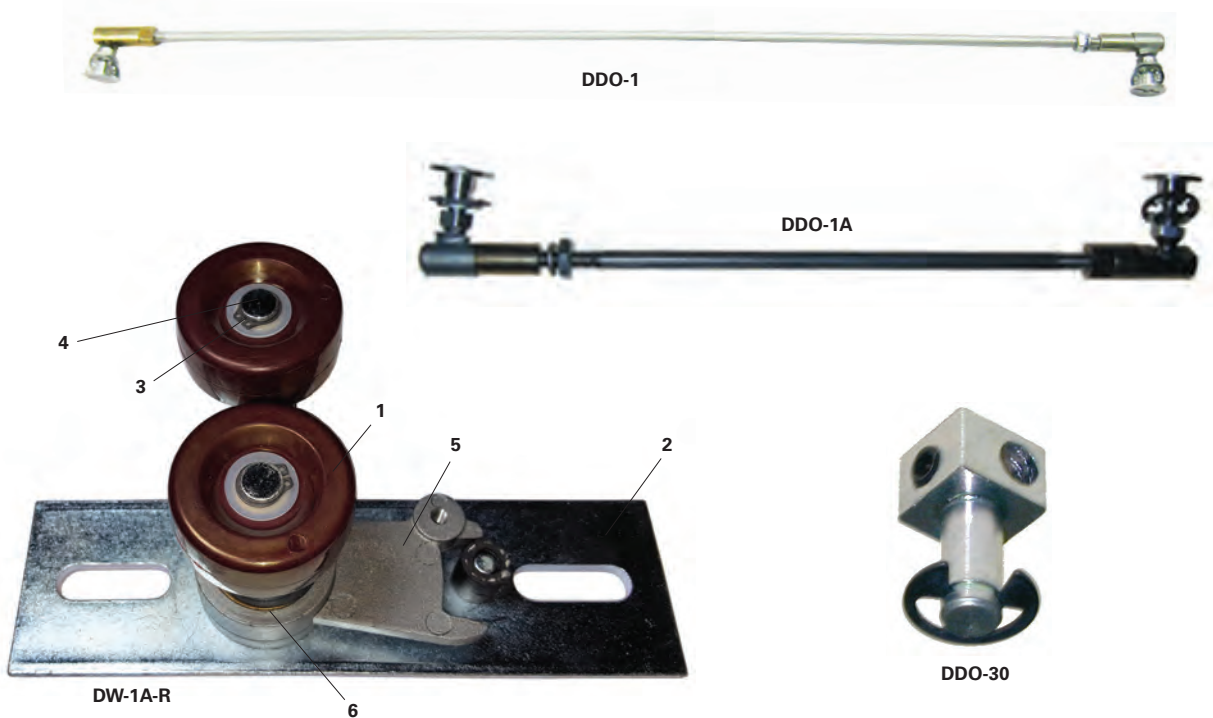

Rod Assembly

S.E.E.S. #	O.E.M. #	Description
DDO-1	9828667 9866760	Ball joint and rod link kit for interlock hook and Dover series door clutch roller assemblies, rod 18" L
DDO-1A	129995	Ball joint and rod link kit for restrictor clutch, rod 8" L
DDO-30	9747035	Rod Attachment

Door Pick-up Roller Assembly

Item	S.E.E.S. #	O.E.M. #	Description
1-6	DW-1A	9875256, 47526	Pick-up roller assembly, with steel mounting base. Assembled L.H. (interchangeable L.H. or R.H.)
	DW-1A-R	9875268, 47525	Pick-up roller assembly, as above. Assembled R.H. (interchangeable R.H. or L.H.)
1	DW-1-P	D-803R1-POLY	Roller kit, 1-5/8" O.D. Poly Blue with Bushing and ring
	DW-1-PS	D-803R1-POLY-SOFT	Roller kit, 1-5/8" O.D. Poly Black - Soft with Bushing and ring
2	DW-1B	9897641, 29764	Steel base for DW-1A assembly
3	DW-1C	9736141, 70115	Retaining ring for DW-1
4	DW-1D	9801157, 40115	Shaft for DW-1 roller
5	DW-1E	9838181, 47529	Roller crank
6	DW-1F	9759268, 75926	Ring Tru-Arc, 1" shaft
	DW-1G	D-803R1, 9721058	Roller Kit, Replacement for Ja IVO / 3S (3 wheels & Hdw)
	DW-1G-1		Shaft, for DW-1G
	DW-1-HDW		Hardware Kit for DW-1, Retaining Ring and Washer, Bag of 10
	DW-1S		Pickup Roller, with Shaft and Retaining Ring
	DDO-205R		Interlock Conversion Kit, R.H.
	DDO-205L		Interlock Conversion Kit, L.H.
	DDO-206R		PU Roller, Conversion Kit, R.H. - US
	DDO-206L		PU Roller, Conversion Kit, L.H. - US



DW-1-P

S.E.E.S. #	O.E.M. #	Description
DDO-3	9838521, 9892916	Door contact base block assembly , steel spring contact blades and silver contacts on a heavy duty insulator, used on DDO-3B, DDO-3C, DHE-3 and DHE-5
DDO-4	9751221	Contact , movable contact assembly
DDO-3B	9865056, 66505	Interlock assembly , R.H.
DDO-3C	9865044, 66504	Interlock assembly , L.H.
DDO-3E	9838466	Cover , only, for interlock
DDO-3E-A	9838466	Cover , only, for interlock, with UL Label
DDO-3F	9863021	Interlock , 297BJ2
DDO-5	9866760, 9838776, 9838375, 9801042, 9875219	Interlock latch assembly
DDO-6	9866760	Nose contact bridge included in DDO-5 assembly
DDO-6C	9801042	Contact , only, for DDO-6 contact bridge
DDO-32	9701230	Cam , slow down switch cam
DDO-33	9701692	Cam , stop/limit switch cam
DDO-33A	44127	Cam shaft , for DC-68 door operator, 5-1/4" L



DDO-3



DDO-4



DDO-3B



DDO-3E



DDO-5



DDO-6C



DDO-32



DDO-33



DDO-33A



DDO-5A



DDO-5B

S.E.E.S. #	O.E.M. #	Description
DDO-5A	9801352	Mounting bolt , 1-15/16" O.L., 3/8-24 thread for interlock latch assy. DDO-5
DDO-5B	9801224, 9801479	Mounting bolt , 1-1/4" O.L., 3/8-24 thread for interlock latch assy. DDO-5
DDO-7	9701011, 9758525	Bushing set , 4 piece, nylon, includes DDO-7A and DDO-7B
DDO-7A	9701011	Nylon bushing , 1/2" per print
DDO-7B	9758525	Nylon bushing , 1/4" per print



DDO-7A

DDO-7



DDO-7B

S.E.E.S. #	O.E.M. #	Description
DDO-8	9850909, 45090	Contact , gate switch, for Dover door operator, clear acrylic plastic with silver plated brass contact for gate switch contact
DDO-9	9772637, 77263	Gate switch contact for DC-68 Door Operator, makes with 9850909

Interlock 66000 & 66001 Components

S.E.E.S. #	O.E.M. #	Description
DDO-10	9761263, 66126	Interlock latch contact , movable, brass base with two 3/8" diameter silver contacts
DDO-10A	9780373, 28037	Insulator for DDO-10
DDO-10/10A-1		Base & Contact to make DDO-10 & 10A
DDO-11	9761457, 66145	Contact for interlock switch , stationary, two needed for DDO-10

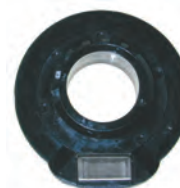

DDO-8

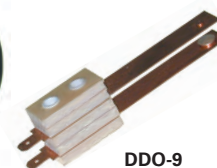

DDO-9



DDO-10



DDO-10A



DDO-10/10A-1



DDO-11



**No Maintenance!
No Repairs!
No Call Backs!**

*No field modifications needed.
All mounting hardware included.*

DO IT RIGHT THE FIRST TIME

"THE REQUIREMENTS FOR DOOR RESTRICTORS WAS IMPLEMENTED TO PREVENT PASSENGERS FROM FALLING INTO AN OPEN HOISTWAY UNDERNEATH THE ELEVATOR PLATFORM WHILE TRYING TO EVACUATE FROM AN ELEVATOR THAT IS STUCK BETWEEN FLOORS."

-AMERICAN SOCIETY OF MECHANICAL ENGINEERS

ELECTRICAL vs. MECHANICAL

Requires electric power & battery back up at all times.	vs.	Works even when power is out.
Coils burn up from continuous use.	vs.	Plastic edging protects wires & cables.
Functionality affected by severe temperatures (hot or cold).	vs.	Works in all types of weather conditions.
Required maintenance on plunger, battery, or PC Boards.	vs.	Maintenance Free!
Many false entrapments & call backs.	vs.	No Call Backs!
High Product Costs.	vs.	Lowest cost solution.

SEES RESTRICTOR: THE PREFERRED MECHANICAL DOOR RESTRICTOR



PART# SEES-RESTRICTOR-001 (CAM 60")



PART# SEES-RESTRICTOR-002 (CAM 50")

PART# SEES-RESTRICTOR-003 (FLAG SMALL ADJUSTABLE 1.25"-2")



PART# SEES-RESTRICTOR-004 (FLAG LARGE ADJUSTABLE 2"-2.875")



PART# SEES-RESTRICTOR-005 (SHIM KIT w/ HARDWARE)



PART# SEES-RESTRICTOR-006 (FLAG FIXED 1" LENGTH)



PART# SEES-RESTRICTOR-007 (FLAG FIXED 3" LENGTH)



SEES-DWT-001 SEES DOOR WEDGE TOOL

Always Smooth Sailing **SEES**[®]



Door Parts and Equipment

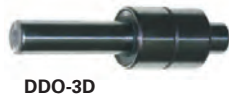
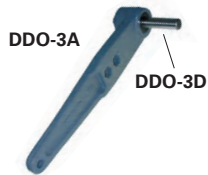

DC-68 Mark II Components

S.E.E.S. #	O.E.M. #	Description
DDO-3A	9838820, 40006	Idler arm with bearing
DDO-3D	9759372, 85107	Bearing for DDO-3A
DDO-17	9791577, 69157	Switch assembly for DC-68 Operators
DDO-18	9876686, 67668	Sheave, 12" for jack shaft, mounts on DDO-3A Arm assembly, replaces old style 13" sheave, for DC-73 & DC-85 Operator
DDO-18A	9843954, 44395, 9820966, 9811667	Motor pulley
DDO-18B	9842214	Drive Sheave, 14" for DC 68 Operator, for DC 68 & 91 Operator



Gibs

S.E.E.S. #	O.E.M. #	Description
DDO-13F	9807871	Shoe Liner
DDO-13G	9808383	Guide Shoe, 30# Rail, without liner
DDO-15	9881980, 11819	Door guide kits, door gib assembly (replaces 118192)
DDO-15A	9782114, 118190, 76345, 9818170	Gib insert for DDO-15, gib width 1/2"
DDO-15-SS		Door Gib Assembly, Stainless Steel with S/S hardware
DDO-34	9885273, 559AB1, 9897951	Gib, insert Omega, guide liner 7/8" x 6"
DDO-34B	9897940, 9897938	Omega Guide Shoe Assembly, upper & lower, 454AC3/454AC4
DDO-34C	196CE2	Mounting Bracket, for Omega Guide Shoe Assembly #256AX1 for 2"
DDO-34D		Pivot Shaft, for Omega Guide Shoe
DDO-41	9885237	Gib, Freight gate guide shoe gib, metal
DDO-41A	9811400	Liner, Freight gate shoe liner phenolic
EPCO-GIB-T T		Door Gib, Adjustable 1/2" W blue nylon
DDO-203	9875220	Hook Assembly, for Low Pocket Interlock Right Hand
DDO-204		Door Gib, Guide Assembly Heavy Duty Plow Replacement
DDO-204A		Door Gib, Guide Assembly with Shaft Heavy Duty Plow Replacement
DDO-204B		Shaft, Only for DDO-204 and DDO-204A Heavy Duty Plow Replacement
DDO-204C		Door Gib, Bracket & Guide Assembly with Shaft Heavy Duty Plow Replacement
DDO-207	9710398	Stiffener Angle
DDO-208		Retainer Linear (EA51-11)
DDO-209		Shim Retainer
DDO-210		Retainer, Saftey Door



DDO-13F



DDO-15

DDO-15A



DDO-34



DDO-15-SS



DDO-34B



DDO-34C



DDO-204



DDO-204B



DDO-204A



DDO-41



DDO-41A

Door Parts and Equipment



DDO-25



DDO-25A



DDO-25B



DDO-25C



DW-12



DW-12A



DW-12B

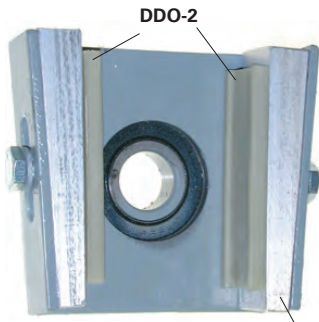

DDO-21

DDO-21B

■ DW-12 Spacer and DW-12B Bolt used for DDO-21, DDO-21A, DDO-25 and DDO-25A



DDO-13



DDO-13A



DDO-13B



DDO-13C



DDO-13D



DDO-37



DGS-200

S.E.E.S. #	O.E.M. #	Description
DDO-25	9723997, 9811667, 123992	Arm , adjustable 8-1/2" L x 2" W x 1/2" Thick
DDO-25A	9723985, 9801947, 103260, 123990	Arm and bearing assembly , for slide assembly 5" L x 2" W x 1/2" Thick
DDO-25B	98384541, 108678	Connecting Arm , 12" DC 68 2 with bearing
DDO-25C	9838831	Link , Connecting 7.5" Print 111195
DDO-21	9838697, 63869	Slide Assembly complete
DW-12	9801236, 40121	Spacer , arm bearing, used with DDO-21, 21A, 25, 25A
DW-12A	9801170, 40117	Spacer for door hanger, used with DDO-21, 21A, 25, 25A
DW-12B	9700742	Screw socket , 3/8-16 x 1-1/4"
DDO-21A		Bracket and bearing for slide assy DDO-21
DDO-21B	9806623	Slide holder for DDO-21 assembly
DDO-2	9838685	Slide insert for DDO-21 assembly 2-1/2" L x 3/4" W
DDO-13	9805266, 10526	Ivo slide guide shoe , 5-1/2" x 1", 3-1/2" c/c mtg., used with DDO-13C Holder
DDO-13A	9808267, 40826	Base , guide shoe
DDO-13B	40828	Shaft with nut , guide shoe
DDO-13C	9808279, 40827	Holder , guide shoe, 5-1/2" x 2.15", includes DDO-13 guide shoe installed
DDO-13D	9808292	Cushion
DDO-13E	9753485	Bumper , Door, Rubber 3/4" diameter
DDO-37	9814656, 114653	Door stop bracket
DRP-32B	298AG2	Interlock , Mechanical, for Dover
DGS-200	9769286	Insert , Guide Shoe Liner, IVO
DHDW-001	131AKI, 9898653	Spacer , Rubber 1.125 O.D.

Door Parts and Equipment

S.E.E.S. #	O.E.M. #	Description
DDO-18A	9820966, 9811667 9843954, 44395	Motor pulley , 2" O.D., 1-1/2" O.D. for two V-belts, I.D. for 1/2" shaft, used with DDO-31 for HD-73 Operator
DDO-31	9746602	Door Motor , permanent magnet door motor 1/6 HP 230 VDC, 1140 RPM, shaft 1/2", uses DCH-17 brush. 8 amps & 48 frame
DDO-31A	9711739, 101172	Rear bearing assembly , includes DDO-31C strap
DDO-31C		Strap upper and lower for rear bearing assy
DDO-31D	9711715, 101171	Main bearing assembly
DDO-31E	9801704, 141707	Door motor , 1/6 HP, 1340 RPM, 115 VDC, uses DCH-18 brush, shaft 1/2"
DDO-31EA	9872070	Door motor , 1/6 HP 1145 RPM, 230 VDC PM
DDO-31F	9741770	Pulse Tach , assembly for DDO-31E
DDO-31F-A	141771	Interrupter , photo sensor
DDO-31F-B	228AE2	Interrupter Wheel
DDO-31F-C	OJ3703/OS3701	Harness Assembly
DDO-31F-D		Magnetic Switch , 2 wire used on Tach, hamlin
DDO-31F-E	711AB2	Housing , for Pulse Tach
DDO-31G	9877228	Encoder for Tach 20/50 1024cpr, for governor
DDO-31H	9861982	Door Motor Encoder , for Smart Tech HD9, includes mounting plate & hardware
DDO-31I	9815740, 6300FA1	Encoder , for governor
DDO-31M	9723420	Motor mount , rubber shock absorber
DDO-46	9779504	Motor , Door with Encoder, 1/6HP, 115 VDC, 1.4 amp, RPM 1150, Class F type 1350
DDO-46A	9825431	Encoder , For door motor DDO-46
DDO-47	9841775	Motor , with sensor, 1/6HP, 115 VDC, 1.4 amp, RPM 1150, Class F type 1350
DS-54	9807536	Transducer , Terminal, NTSD/ETSD
DS-55	9780853	Transducer Assembly , Position
TDO-01	9817920	Door motor , R/H 120 VDC 1/6HP encoder & drive pulley assembly



DDO-18A

DDO-31



DDO-31A

DDO-31C



DDO-31E



DDO-46



DDO-31F-C

DDO-31F-B

DDO-31F-D

DDO-31F
(Replaces all prior models)



DDO-31EA

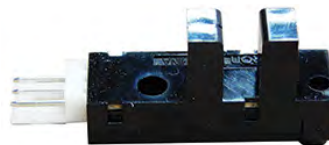

DDO-31M



DDO-31G



DDO-31H



DDO-46

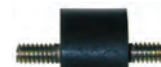

DDO-31M



DDO-46



DDO-31G



DDO-47

Door Parts and Equipment

DOVER

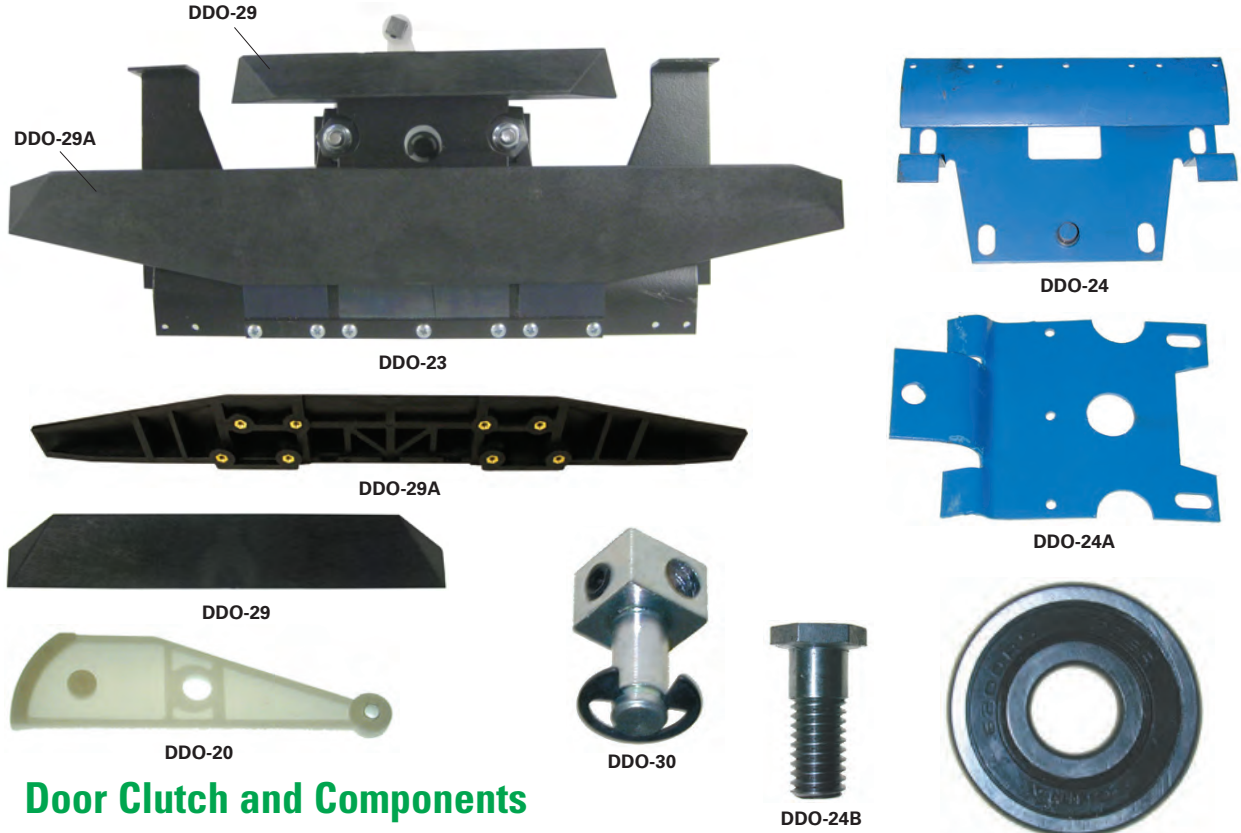

Door Clutch and Components

S.E.E.S. #	O.E.M. #	Description
DDO-22	9863862, 63856, 9951568, 127235	Clutch assembly, L.H.
DDO-23	9863898, 63891, 9951570, 127236	Clutch assembly, R.H.
DDO-29	9801443, 9811667	Closing clutch vane 9"
DDO-29A	9800955, 40099	Opening clutch vane 20"
DDO-24	9838703	Clutch base, R.H. or L.H.
DDO-24A	9800141, 40014	Closing vane support
DDO-24B	9819642, 41964	Bolt used with DDO-24C
DDO-24C	9870076, 77007	Bearing used with DDO-20 actuating cam
DDO-24D	392CH1	FS, Screw, CSH Shoulder, CE 2.25" OA Length Shank
DDO-24E	392CH2	FS, Screw, CSH Shoulder, CE 1.875" OA Length Shank
DDO-20	9800888	Cam, clutch actuating cam
DDO-30	9747035	Rod attachment
DSE-1L	9822276	Link Rod
DDO-12	9801066	Spring vane, flat, 2-1/2" H x 2" W
DDO-14	9838806	Spring vane, flat, 4" x 4"
S.E.E.S. #	O.E.M. #	Description
DW-13	9780158 9701588	Sheave, 2.4" O.D. x .3937" I.D. for 40158 DW-13B assembly
DW-13A	9838594	Bracket for DW-13B assembly
DW-13B	9838594 9950965	Relating cable assembly, includes DW-13 and DW-13A

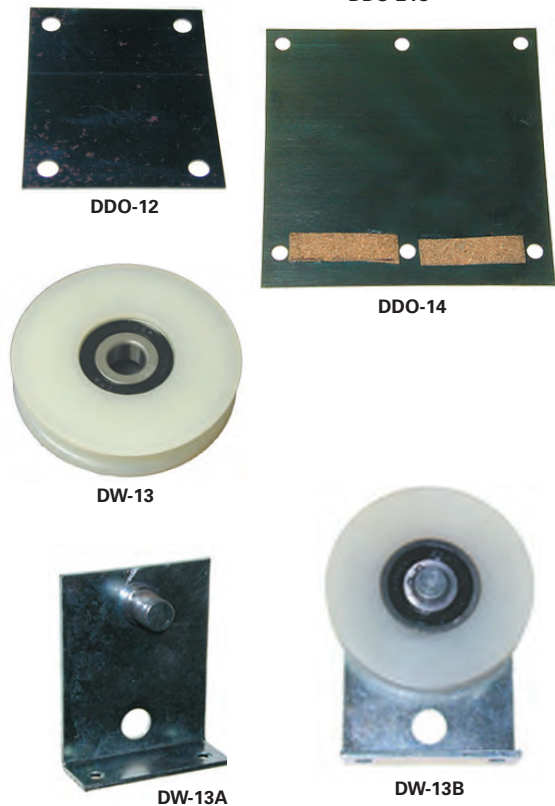

Door Parts and Equipment

S.E.E.S. #	O.E.M. #	Description
DDO-40	9954090	Door restrictor assembly , 5ft length
DDO-40A	147721	Spring for DDO-40 Door restrictor
DDO-40B	9954144	Angle Bracket , set, angle for restrictor
DDO-40C	9954132	Header Bracket for restrictor
DDO-40D	9779486	Restrictor Angle Assembly , 72" for 8ft Pivoting Door
DDO-40E	9779498	Restrictor Angle Assembly , 9ft Pivoting Door
DDO-40BC-KIT	9743297	Hoistway Restrictor Kit , includes one each DDO-40B & DDO-40C
DDO-42	860AE14	Car Door Hanger Rail , 98" Dover, "J" (no holes)
DDO-43	9782266	Old Style Central Cable , for LDO-3 door operator
DDO-45	9836408	LDO-3 Operator Magnet & Sensor kit , N.O.
DDO-200	9710190	Bumper , for Door Recess Mounting
DDO-201	118194	Retainer , Fire Tab Z Bracket
DDO-202	9848071	Door Guide , Gib Assembly
DDO-203	9875220	Hook Assembly , for Low Pocket Interlock Right Hand

Center opening doors need two each DDO-40B for intermediate floors, one each for top and bottom (terminal) floors. Single opening doors need one each DDO-40B and DDO-40C per floor, per car.



DDO-40



DDO-40A



DDO-40B



DDO-40C

For more door restrictor options, see SEES Restrictors on page 261.



DDO-42
Close up



DDO-200



DDO-40BC-KIT



DDO-45



DDO-201



DDO-202

DMC Operator Components

S.E.E.S. #	O.E.M. #	Description
DDO-35	9741227, 141222	Door cam limit for HD-85
DDO-36	9741252, 141251	Magnet for DDO-35
DDO-36A	9741653, 141555	Reed switch assembly for DMC Car Top
DCB-200	9710565	Brush , Door Motor Reliance Model M
DMC-001C	9850922	Cable , for DMC Laptop Tool



DDO-36A



DMC-001C



DDO-35



DDO-36



DHE-1

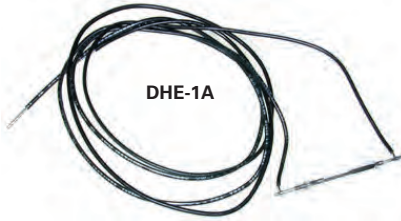

DHE-1A

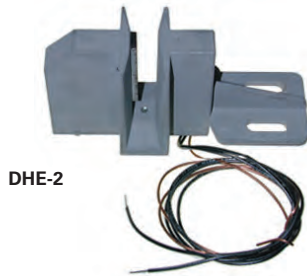

DHE-2



DHE-3A



DHE-200

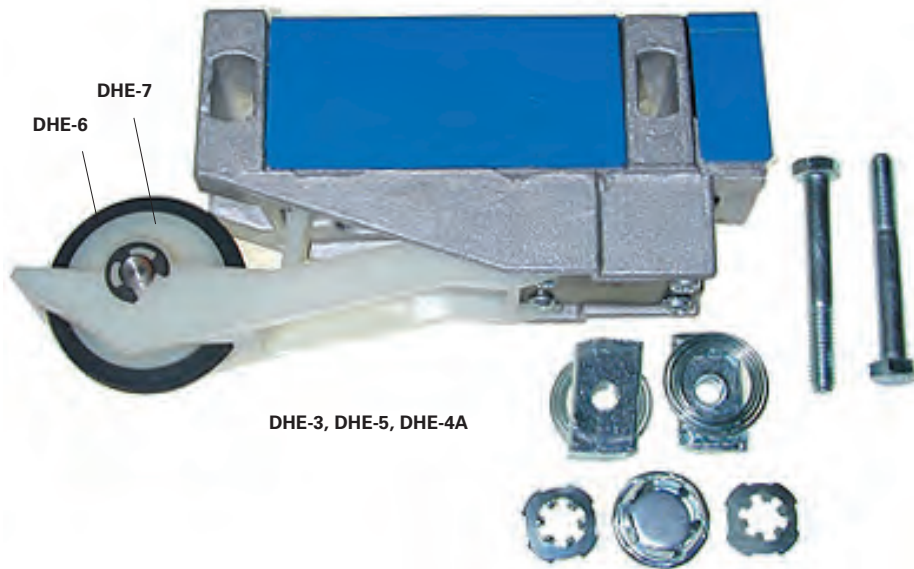

DHE-3, DHE-5, DHE-4A

Hatch Equipment

S.E.E.S. #	O.E.M. #	Description
DHE-1	9769729, 45731, 69726	Switch , magnetic leveling, N.O., wires out of side Max. voltage 270 AC or DC
DHE-1A	9865743	Reed switch assembly , Replacement parts to repair Magnetic Leveling Switches DHE-1, DHE-2
DHE-2	9813421, 113204	Switch , magnetic leveling N.O., wires out of back. Max. voltage 270 AC or DC
DHE-3	9711557, 69290	Limit switch , 230V, normally closed
DHE-3A		Spring Hinge , for DHE3 and DHE-5
DHE-5	9711545, 115164, 105701	Limit switch , 230V, normally open
DHE-6	9768695	Tire for DHE-3, DHE-5 and DHE-4A
DHE-7	9706847	Plastic wheel without tire
DHE-8	9857072	Contact block , stationary for DHE-5
DDO-3	9892916	Contact block , for DHE-3
DPC-32A	298AG2	Auxiliary Contact Block , N.O/N.C.
DHE-4A	9755585	Limit Switch , D.P./N.C., DMC-1
DHE-200	9848903	Reed Switch Kit , [TIII]

Encoders and Tachometers

S.E.E.S. #	O.E.M. #	Description
DMP-16	9716154, 373AA1	Encoder flange mount, 2048 CPR
DDO-48	9716166	Encoder, 5VDC, 5000 CPR
DDO-49	9716520	Encoder assembly, flange mount, T4 and VVF geared, 2048 CPR, coupling (.5" x 3/8") included
DRP-33	9740521	Tachometer, Tandem Style
DMP-23	9849257	Tachometer, 50V, 1000RPM, foot mount, 1/2" shaft
DMP-200A	9875261, 9877228	Encoder, Positioning 5-28 V [This replaces the 373AR1]
DMP-200B	9719234	Encoder Regulator Kit, Includes Regulator Card, Brackets and Hardware
DMP-17	9780233	Flexible Coupling, for MM II Tachometer
DMP-17A		Coupling, 3/8" x 3/8"



DMP-16



DDO-48



DMP-200A



DRP-33



DMP-200B



DMP-17



DMP-17A



Machine Parts

Jack Packing for Dover

S.E.E.S. #	O.E.M. #	Description	Plunger Size
PAC-44	1A084-10, 9832907	Autopak for IVO-3S (includes "O" ring)	3-7/8"
DPAC-20	3EA023-01	Packing, Rotary Lift (2 Seals, Lantern Ring)	4-3/8"
DPAC-20A	3EA024-04	Packing, Set (2 Seals, Lantern Ring)	4-1/2"
DPAC-21	3EA023-02	Packing, Rotary Lift (2 Seals, Lantern Ring)	5-7/16"
DPAC-22	3EA023-03	Packing, Rotary Lift (2 Seals, Lantern Ring)	6-1/2"
DPAC-22A	3EA023-11, 9787239, 9870349	Packing, 3S, (Rota Seal & Wiper)	3-1/2"
DPAC-22B	9844600	Jack Seal Kit, 3T	
DPAC-22C	9851094	Packing, 3S, (Rota Seal & Wiper)	
DPAC-22D	9844612	Jack Seal Kit, 2.5T	
DPAC-23	3EA023-12, 9787240, 9705272	Packing, 4S, (Rota Seal & Wiper)	4-3/8"
DPAC-23A	4E003, 9787240, 9708467	Packing, 4S (Rota Seal Only)	4-3/8"
DPAC-24	3EA023-13, 9787252, 9705442	Packing, 5S, (Rota Seal & Wiper)	5-7/16"
DPAC-24A	4E004, 9787252	Packing, 5S, (Rota Seal Only)	5-7/16"
DPAC-24B	9851010	Jack Packing Parker, 5S	
DPAC-25	3EA023-14, 9787264, 9705612	Packing, 6S, (Rota Seal & Wiper)	6-1/2"
DPAC-25A	4E005, 9787264, 9708480	Packing, 6S, (Rota Seal Only)	6-1/2"
DPAC-25C	9743066	Packing, 7S, (Rota Seal & Wiper)	7-1/2"
DPAC-25D	10-72-R06500-LF10Z	Dover S Head	6-1/2"
DPAC-26	06-00S03000	Packing Set, holeless LF2 OZ packing set (1 jack)	3"
DPAC-29	9723821	Jack Wiper Ring, 3S	

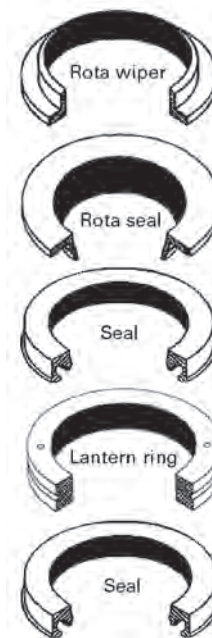

DPAC-21



DPAC-21A



DPAC-21B

Machine Seals

Designed for dependable service with ease of installation.
Heat and oil resistant material provides positive sealing performance.

S.E.E.S. #	O.E.M. #	Doover Worm Gear Seals	Seal Dimensions
DPAC-21A	5E006, 9767897, 76789, 9808644, 108644	Spider Seal , (Split), for GD-45	5-1/8" x 7" x 1/2"
DPAC-21B	9767894	Pedestal Shaft Seal for GD-45	5-1/8" x 7" x 1/2"
DPAC-25B	5E004, 9825526, 112733	Spider Seal , (Split) for GD-105	7-1/8" x 8-5/8" x 1/2"
DPAC-30A	1R043, 9763326, 76332 9752110, 75211	Worm Gear Seal , Split, with Deflector, machine # GD-45, GD-50, GD-75	1.749" x 2.650" x .500"
DPAC-31	1R002, 9825514 9752122, 26586	Worm Bearing Seals , Split with Deflector for GD-105, GD-200 and GD-240	2.345" x 3.220" x .500"
DPAC-31A	1R048	Worm Gear Seal , Split (Inner), for 1R048	4.5" x 5.5" x .625"
DPAC-31B	5E005, 9824479, 72447 9722701, 72270, 9808760, 108763, 108763	Spider Seal , (Split) for GD-50, GD-75, GD-200, GD-240 and GD-300	8-1/2" x 10-1/4" x 1/2"
DPAC-32	9779231, 77924	Worm Seal , Gland packing, for GD-300	3" x 4" x .500"
DPAC-33	9840503	Worm seal , for GDF-25	2" x 4.5" (flange) x .75"
DPAC-36	9857648	Worm seal , for GD1	



DPAC-27

S.E.E.S. #	O.E.M. #	Description
DPAC-27	9873200	Seal , Oil Output GD1, 5.256" x .438"
DPAC-28	9873223	Seal , Oil Worm with Carrier
DPAC-28A	9873223	Seal , Oil Worm
DPAC-31C	9824479	Pedestal side seal , for GD-240, GD-200, 4.88" x 6.25" x .5"
DPAC-34	9825538	Oil Seal , for GD 45, GD 105
DPAC-35	9740053	Adapter Seal , 10.125" for GD 105



DPAC-28



DPAC-34



DPAC-35

Bearings and Shims



DMP-1



DMP-3A



DMP-5A



DMP-6A



DMP-6B

S.E.E.S. #	O.E.M. #	Description
DMP-1	9818121	Shim , .002 red, GD45
DMP-1A	9818110	Shim , .005 blue, GD45
DMP-2	9745099	Shim , .002 red, GD75
DMP-2A	9745105	Shim , .005 blue, GD75
DMP-3	9812740, 112730	Shim , .002 red, GD105
DMP-3A	9812726, 112732	Shim , .005 blue, GD105
DMP-4	9778780	Shim , .002 red, GD240
DMP-4A	9778792	Shim , .005 blue, GD240
DMP-5	9880276, K91509	Thrust bearing for GD-45 machine, I.D. 1.875", O.D. 3.730", Thick. 1.224" x 2 + .250" Shim
DMP-5A	9767903	Spider shaft bearing set , GD-45 pedestal side
DMP-5B	9767915	Spider shaft bearing set , GD-45 ring & oil seal side
DMP-6	9702453, K91509	Thrust bearing for GD-105 machine
DMP-6A		Thrust Bearing Cover Gasket , GD105
DMP-6B	9812787	Gasket , D105 Adjustment cover GD105
DMP-7	9789807	O-Ring , (outboard) 4.012" x 3.734"
DMP-8	9715113	O-Ring , worm cover plate 4.9" x 5.2"
DMP-8A	9812763, 112758	O-Ring , GD-105 4.609" x 4.877"
DMP-9	9715101	O-Ring , thrust end 5.6" x 5.8"

Machine Parts

Bearings and Shims

S.E.E.S. #	O.E.M. #	Description
DMP-10	863230, 26323	Brass sleeve for brake assembly, 5.25" L x 2.625" O.D.
DMP-10A	9792790	Gasket , neoprene 2-1/2" O.D. x 2.15" I.D. x 1/16" thick, for DMP-10 Brass sleeve
DMP-11	98063242	Plunger for brake assembly 4.187" L
DMP-11A	9833316	Plunger for brake assembly 5.2" L
DMP-11B	9814286	Brake Solenoid Retrofit Kit Plunger , Sleeve & end plates
DMP-12	9715125	O-Ring , thrust end, 5.9" x 6.2"
DMP-13	9824820, 9830145	Thrust bearing set for GD-75-1
DMP-13A	9824856, 32485	Thrust bearing set for GD-75-2
DMP-14	9880288	Thrust bearing kit for GD-240, includes bearing set, shims, o-ring seal, washer, nut
DMP-14A	9778779	Thrust bearing for GD-240
DMP-14B	9778809	Inner bearing for GD-240
DMP-15	9813512	Oiler , felt wick
DMP-15A		Lubricator Wick , 22-1/2 lbs. - 30 lbs.
DMP-18	9723584	Dampening/Vibration Pad , 1" x 3.25" x 6"
DMP-19	9742906	Wick , Lubricator, felt formed to fit rail
DMP-21	9844636	Bearing Kit , Jack 2.5 T, 2.5"
DMP-24	9858214	Pad , ISO 6" x 3.25" x 2"
DMP-25	9754816	Pad , ISO with plug
DMP-26	9713154	Pad , ISO pad 5 pack
DDO-26	9705478, 70547	Rubber cushion , 2" O.D. x 1-1/2" brake pulley or machines GD-45, GD-50, GD-75, GD-105, GD-200, GD-240, GD-300
DDO-26A		Rubber cushion , brake pulley, 1-1/4" x 3/4" x 1-3/8" L
DDO-26B	20980	Shoulder bolt , Drum Bush For DDO-26
DMP-105-KIT		GD-105 Rebuild seal kit 15 pc. Less bearings
DMP-200	9863254 / 26325	Cork , Geared Solenoid Brake Pad, 5.25" x 2.875" x .125"
DMP-201	9772017	Bearing , for 66700 and 5501AE Governor
DMP-202	9833511	Inspection Cover , Geared Machine, Clear



DMP-10



DMP-11



DMP-11A



DMP-13



DMP-14B



DMP-18



DMP-24



DMP-25



DMP-26



DMP-200



DMP-201



DMP-202

Printed Circuit Boards

S.E.E.S. #	O.E.M. #	Description
DPC-71	9746250	Power Supply +5V @16A
DPC-77A	9773113	PCB Pushbutton, 48VDC Print# 6300KJ2
DPC-77B	9773101	PCB Pushbutton, 24VDC Print# 6300KJ1
DPC-118	9749160	Regulator Card PC Board
DPC-122	9781444	Power Log 24V PC Board
DPC-126	9803877	Door Operator Board
DPC-160	9816653	Current Regulator Board
DPC-154	9803889	UDC Tac PC Board
DPC-149	9716853	Digital Current Regulator T4 PC Board
DPC-158	9816380	Inverter T-IV PC Board
DPC-155	9813925	LSZ Card, T2 PC Board
DPC-166	9835842	Motor Field Regulator Board
DPC-159	9816392	QSR PC Board
DPC-207	9875247	Door Operator Board
DPC-208	9875851	Dover S5ST Speed Control
DPC-150	9755470	Snubber Board T-IV
DPC-165	9835647	Inverter Card PC Board
DPC-209	9815600	Processor PC Board
DPC-173	9816124	Board PC Board
DPC-174	9719817	Software DMC-1 CLC Type 12
DPC-161	9816770	IGBT PC Board
DPC-101	9716830	HDW/VAC. CON T4 PC Board
DPC-133	9839628	Optical Detector PC Board
DPC-135	9840266	Optical Level PC Board
DPC-136	9840965	Optical Emitter PC Board

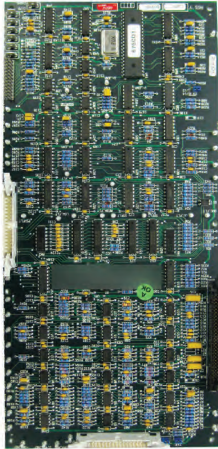

DPC-118

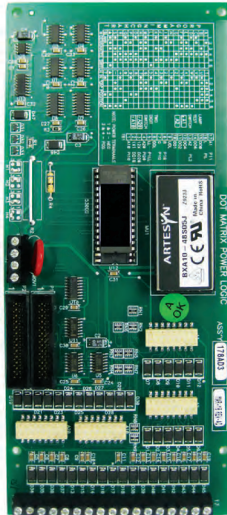

DPC-122



DPC-126



DPC-133



DPC-150

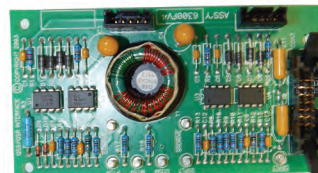

DPC-159



DPC-136



DPC-135



6ea. come with DPC-135

Printed Circuit Boards

S.E.E.S. #	O.E.M. #	Description
DPC-201	9841362	Optical Sensor, Lens & Fiber
DPC-202A	9781146	PC Board, Hall Node
DPC-202B	9782278	Power Supply, with Harness, DM
DPC-200	9823888	Locking Standoff, .5"
DPC-40C	9720315	Suppressor, Transient Assembly
DPC-206	9782813	PCB, I/O Exp., 24 VDC TAC20
DPC-207	9740375	PCB, Card Assy SPI Hi Voltage



DPC-202A

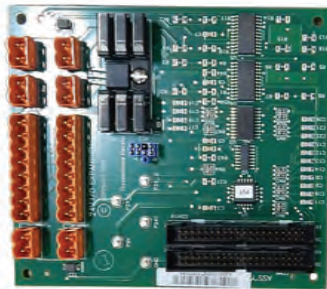

DPC-206

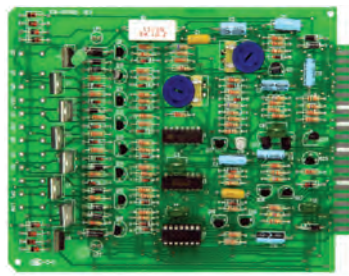

DPC-1A

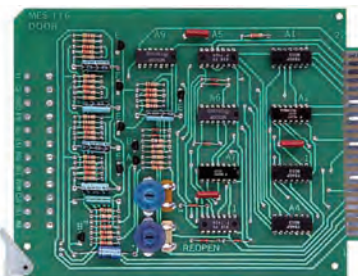

DPC-2A

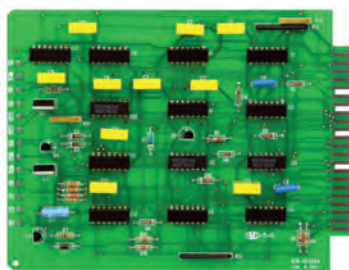

DPC-3A

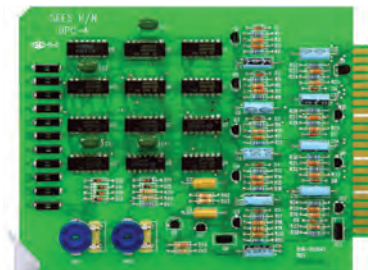

DPC-4

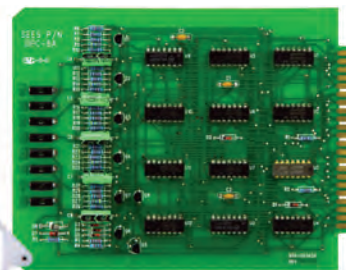

DPC-6A

Hydro PC Boards

S.E.E.S. #	O.E.M. #	Description
DPC-1A	68177, 9855245, 105248	Power PC Board, 4 slot
DPC-2A	68178, 9855233, 124519	Door PC Board, 4 slot
DPC-3A	68179, 9855221, 123948	Car PC Board, 4 slot
DPC-4	68180, 9781808	Logic PC Board, 3 slot
DPC-5	68433, 9884336	Duplex PC Board, 3 slot
DPC-6A	9805254, 105254, 68525	Option PC Board, 4 slot
DPC-7A	9855257, 105251, 6843, 6669	Top & bottom PC Board, 4 slot
DPC-8A	9855269, 105252, 68432, 68432, 66690, 10252	Intermediate PC Board, 4 slot
DPC-9	9781870, 111973, 68187	Reverse phase relay
DPC-30	9768324, 76832	Guide for PC Boards, black plastic
DPC-30A	106364, 106365	Base for DPC-1A, 22 pin socket

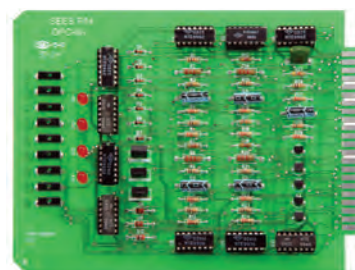

DPC-8A

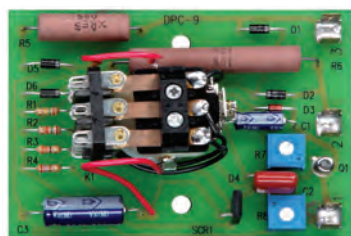

DPC-9



DPC-30

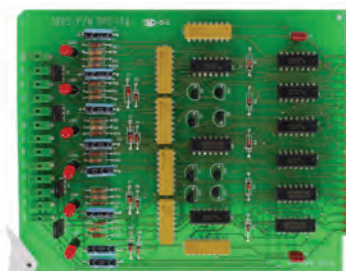

DPC-7A

Printed Circuit Boards

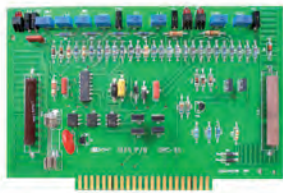

DPC-25



DPC-35

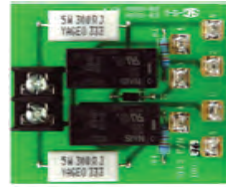

DPC-36

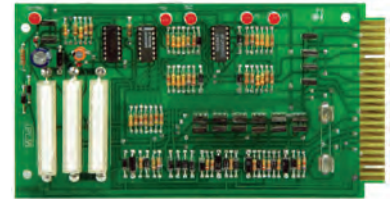

DPC-38



DPC-38A



DPC-39



DPC-39A



DPC-39A-D



DPC-39A-E

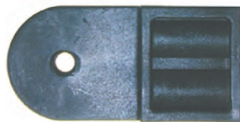

DPC-39C



DPC-39D



DPC-39H



DPC-39H-D



DPC-39H-E



DPC-45

Traction PC Boards

S.E.E.S. #	O.E.M. #	Description
DPC-25	9811989, 111980	Motor field, control PC board
DPC-35	9821170, 102117, 67416	Hall call, single relay PC Board, 48V
DPC-36	9821168, 102116, 67491	Hall call, double relay PC Board, 48V
DPC-38	9811266, 126125	Optical leveling, PC Board
DPC-38A	9834140	Optical Leveling Control PC Board Kit
DPC-39	9812258, 112267, 112264	Emitter/Detector assembly, original version
DPC-39A	124945, 124942	Emitter/Detector assembly, updated version
DPC-39A-D	124942	Detector PC Board, mounting holes .156" diameter
DPC-39A-E	124945	Emitter PC Board, mounting holes .156" diameter
DPC-39B	125750	Base, mounting block for emitter & detector boards
DPC-39C	106365	Mounting bracket for DPC-39
DPC-39D	112264	Detector PC Board, mounting holes .125" diameter
DPC-39E	112267	Emitter, PC Board, mounting holes .125" diameter
DPC-39F	9715460, 610AF1	Emitter, photo emitter assembly module
DPC-39G	9715472, 610AE2	Detector, photo detector assembly module
DPC-39H	9840138	Emitter/Detector assembly with amplifier and filter
DPC-39H-D	6300FC1	Detector, with transistor amplifier
DPC-39H-E	6300FD1	Emitter, with noise filter
DPC-44	9853492	Power supply assembly 24 VDC OUT, 110 VAC IN
DPC-45	9853509	Power supply assembly 24 VDC, 6.25 amps

Printed Circuit Boards and Timers

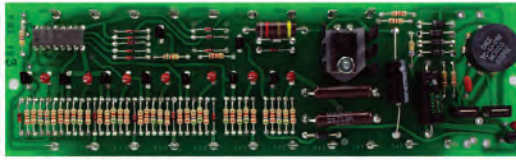

DPC-32

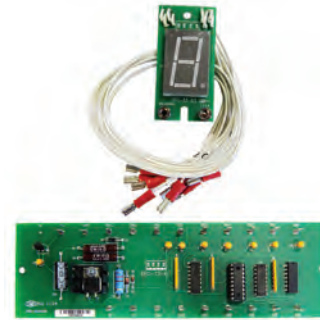

DPC-33-KIT

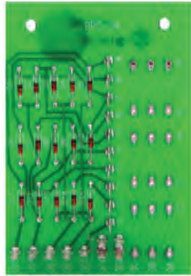

DPC-34

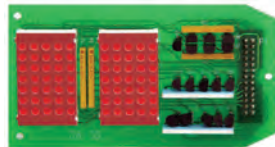

DB-35



DPC-37



DB-37

Car Signal PC Boards

S.E.E.S. #	O.E.M. #	Description
DPC-32	9811382, 9811370, 3329	Power supply card, up-graded version
DPC-33-KIT		PCB & PI LED Display
DPC-34	9813378, 9813366, 3332	Decoder assembly PC Board
DPC-37	9818420, 118412	Emergency light PC Board, LED version, for battery replacement order MIS-194B
DB-35	9835878, 178AC1	Position indicator display board
DB-37	9713232, 178AD2	Power board, logic, 24V
DB-38	9713244, 178AD1	Power board, logic, 48V



DPC-21



DPC-22



DPC-23

Timers

S.E.E.S. #	O.E.M. #	Description
DPC-21	9852037, 124566, 9852001, 9852803, 05201, 65280	Timer, 110 VAC, .1 - 260 sec. timing range
DPC-22	9852049, 124561, 9815284, 9852797, 101528, 65278, 68536, 9885365, 9805278, 105238, 102313	Timer, 20 - 60 VDC, .1 - 260 sec. timing range
DPC-23	9711934, 75301	Timer, 120 VAC, SPDT, 4.5 minutes timing range
DPC-24	9812611, 111261	Timer, for brake relay
DPC-27	9741306, 72533	Timer, 115 VAC, 120 sec timing range
DPC-28	9728375, 62837-1, 78230	Timer, 115 VAC, .1 - .25 sec. timing range, used on "SET" Traction
DPC-29	9728387, 62838-1	Timer, 230V max used on "TLT" and "TMT"
DPC-30	9955215	Timer, 24 VDC
DPC-31	9752810, 75281	Time delay relay, 115V, 60 cycle, 2 - 12 second timing range, octal plug in



DPC-24



DPC-27



DPC-28



DPC-29



DRP-30



DPC-31

Printed Circuit Boards

DOVER

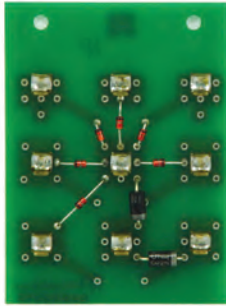

DPC-10

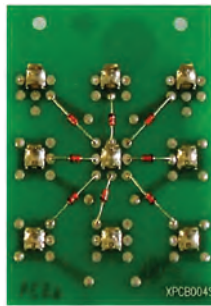

DPC-11

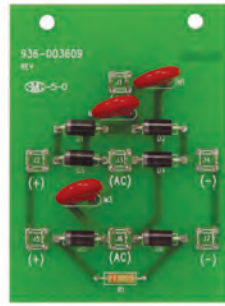

DPC-12

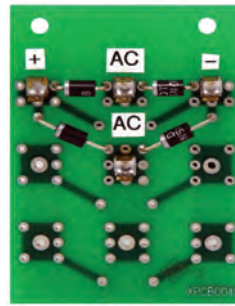

DPC-13



DPC-41

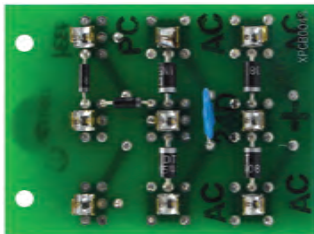

DPC-42

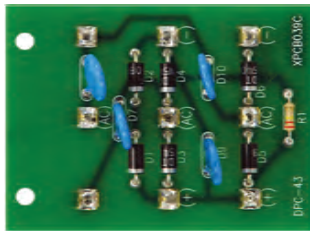

DPC-43

Rectifiers

S.E.E.S. #	O.E.M. #	Description
DPC-10	9892680, 69268, 69283	Zener, diode assembly with regulator
DPC-10A	9892692, 69269	Zener, diode assembly
DPC-11	9892679, 69267	Zener, diode assembly
DPC-12	9879675, 67967, 113149, 111207, 76785	Rectifier, 3 phase, to 300 VDC, 3 amp
DPC-13	9879810, 67968, 67981, 72109, 76824	Rectifier, single phase, to 300 VDC, 3 amp
DPC-41	9841246, 114129	Rectifier assembly, 3 phase, to 300 VDC, 3 amp
DPC-42	9892989, 113065, 67968, 69298, 111208	Rectifier assembly, 2-single phase full wave with diode arc suppressor, 24 volt supply
DPC-43	9715289, 9719842, 115298	Rectifier assembly, 3 phase, to 300 VDC, 18 amp
DPC-26	9841350, 114135	Protector assembly, door operator surge protection assembly
DPC-26A	9804420	Suppressor, Transient Assembly 220V
DPC-40	9856213, 65621	Thyrector assembly, 82V with spade lug
DPC-40A	9791619	Thyrector assembly, used on wire contact realy
DPC-40B	9719880 / 890AF1	Supressor assembly

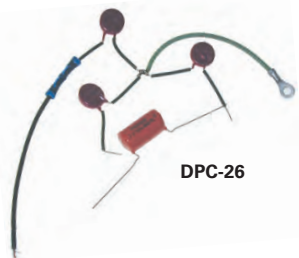

DPC-26



DPC-40



DPC-40B

Printed Circuit Boards and Timers -DMC

DOVER



DPC-47 (FRONT AND BACK)



DPC-58



DPC-48



DPC-48A



DPC-49A



DPC-51



DPC-52

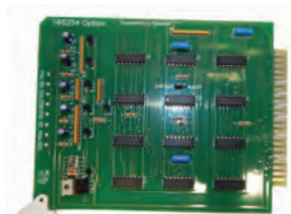

DPC-56



DPC-57MA

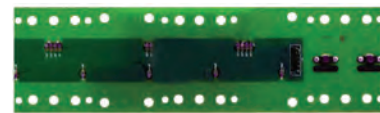

DPC-57



DPC-57M

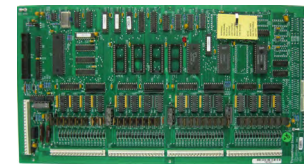

DPC-59

S.E.E.S. #	O.E.M. #	Description
DPC-47	9841507	Power Supply, DMC, 5 VDC, harness not included
DPC-58	9741331	Card Auxiliary Sensor, for DMC 1 and T3
DPC-48	9841313	DMC-1 Selector, PCB 6300CV1/2
DPC-48A		DMC-1 Selector, PCB 6300CV3
DPC-49A	9832875	Door PC Board, HD98, TAC20, and TAC22
DPC-50	9832520	Power Supply, 5V
DPC-51	9816112	Power Supply, DMC, (2) +12, +5, -12 VDC
DPC-52	9853480	Power Supply, 15V 9 Amps
DPC-55	9804304	Power Supply, UPC 500 VAC
DPC-56	9753217	Card, option 6 slot
DPC-57	9841325	Card Sensor, main, DMC-1
DPC-57M		Magnet Holder for DPC-57
DPC-57MA		Magnet, 1.25" L x .365" Diameter
DPC-59	9715710	DMC-1 Card, CLC 6300BP4
DPC-61	9773125	Card, Call Register Light Assembly, 115 VAC
DPC-62	9816124	Power Supply, PCB 110 VAC 24 VDC Out TAC50
DPC-63	9782916	Serial Button Board 6300LL3
DPC-64	9773113	PCB, Lon Node, 6300LM1
DPC-65	9714911	Semiconductor, for GE Drive # 104X125DC061
DPC-137	9841301	Power Unit Relay
DPC-167	9836494	Power Unit Relay with Relays
DPC-171	9851379	Power Unit Relay without Relays



DPC-62



DPC-63



DPC-137



DPC-167

Printed Circuit Boards

Magnetek

S.E.E.S. #	O.E.M. #	Description
DPC-189	9845872	Main, all ratings PC Board

ETSL

S.E.E.S. #	O.E.M. #	Description
DPC-178	9860125	ETSL PC Board

LMH

S.E.E.S. #	O.E.M. #	Description
DPC-179	9804298	Timer X Board
DPC-181	9804286	Control X Board

Load Weigher

S.E.E.S. #	O.E.M. #	Description
DPC-182	9841600	Load weighing Control, T IV

Loop Selector

S.E.E.S. #	O.E.M. #	Description
DPC-183	9833183	Terminal Slowdown Reed, (TFS), 4.7 Ohm, TIII
DPC-156	9813950	LSC PC Board
DPC-129	9836548	PCB, DMC Power Relay Board
DPC-184	9813937	LSS, Signal Shaper PC Board
DPC-185	9812398	LS8 PC Board
DPC-186	9816306	LS3 PC Board
DPC-187	9813779	LS1 PC Board
DPC-188	9812568	LS10 PC Board

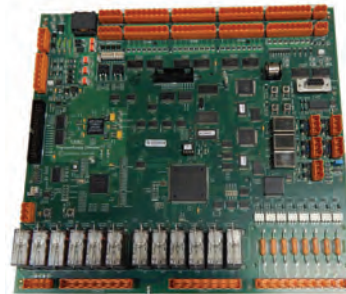

DPC-124

DSP

S.E.E.S. #	O.E.M. #	Description
DPC-104	9719490	VVVF PC Board, without software, T IV, PC Board
DPC-109	9731817	VVVF, SW Vector, without software, T IV
DPC-138	9841349	SCR PC Board, without software T IV
DPC-198	9841349	PCB, Closed Loop BRG GE

MM II

S.E.E.S. #	O.E.M. #	Description
DPC-190	9780040	Field Regulator PC Board, 4 Quad

CPU

S.E.E.S. #	O.E.M. #	Description
DPC-134	9840114	Board ENH, Car, T IV
DPC-124	9782552	Board TAC20M
DPC-177	9782576	Board TAC20S



DPC-198

Printed Circuit Boards

T II

S.E.E.S. #	O.E.M. #	Description
DPC-197	9762218	I/O Transistor Output
DPC-198	9761627	I/O Input
DPC-164	9832063	Generator Field Half Bridge, Generator Field Module Assembly
DPC-199	9832051	Generator Field Module Assembly
DPC-200	9832026	I/O Call, I/O Module Assembly, Locking Standoff

T III

S.E.E.S. #	O.E.M. #	Description
DPC-148	9714881	RTG Board
DPC-144	9863000	PMI I/O Board, 48 Pos, without Modules
DPC-172	9853704	PMI I/O Board, 16 Pos, without Modules
DPC-143	9853686	Main Sensor Board
DPC-170	9841908	DDI PC Board
DPC-119	9760027	DAR-3 PC Board
DPC-202	9853832	Communication Interface, Car/Group
DPC-120	9760052	Regulator Board, Arm Volt 360

Signal Fixture

S.E.E.S. #	O.E.M. #	Description
DPC-131	9835210	LED, Lantern, Hall
DPC-157	9814050	Logic, Dot Matrix Position Indicator
DPC-163	9830431	Dot Matrix Display 1" Position Indicator
DPC-195	9830236	Dot Matrix Display 5/8"

MSC-1 and Model 3

S.E.E.S. #	O.E.M. #	Description
DPC-191	9740259	Tachometer Load Board
DPC-193	9840485	Power, with plug-in terminals, MSC-1

T IV

S.E.E.S. #	O.E.M. #	Description
DPC-102	9716841	Gate Driver, VVVF

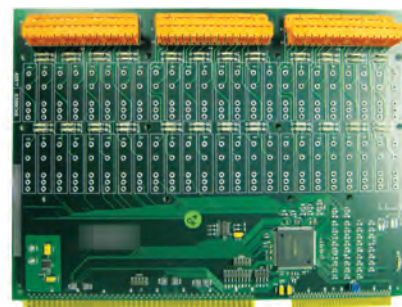

DPC-144

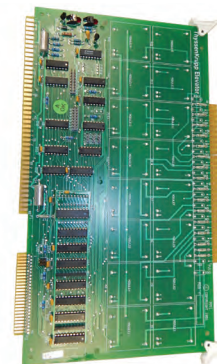

DPC-172

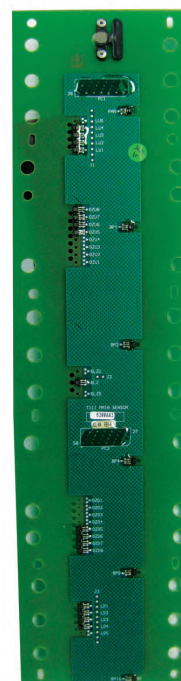

DPC-143



DPC-170

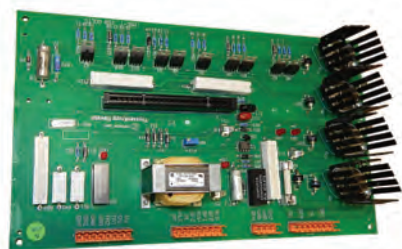

DPC-193



DPC-131

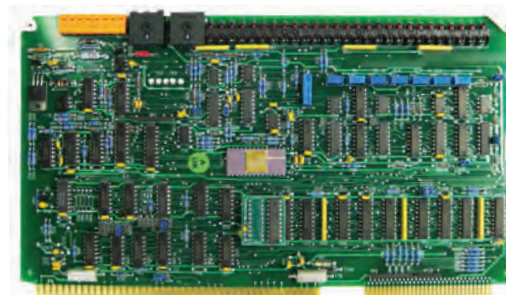

DPC-119

Rectifiers

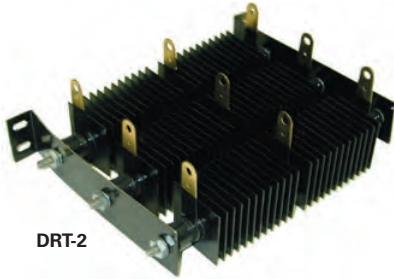

DRT-2



DRT-5



DRT-13-1

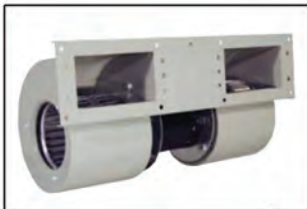

DRT-7-1



DRT-9

Fan / Blower

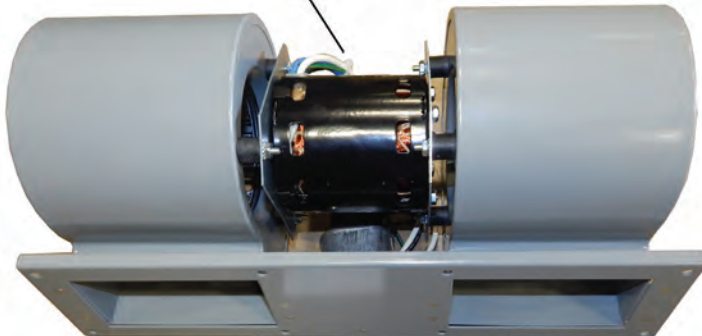

DMP-20

S.E.E.S. #	O.E.M. #	Description
DRT-1	9719842	Doubler , 18 plates, 2.6" x 2.6"
DRT-2	9712082, 27858	Rectifier , Ladder network, 3 phase bridge, 72 plates
DRT-3	9756577	Power block , IGBT, 200 AMP
DRT-4	9756589	Power block , IGBT, 300 AMP
DRT-5	9851719	Rectifier , Toshiba IGBT block 300 AMP kit with thermal compound
MIS-CHEM-002		Thermal Compound , 3CC syringe
DRT-6	9756565	Rectifier , PRX IGBT block 150 AMP kit with thermal compound
DRT-7	9756577	Rectifier , PRX IGBT block 200 AMP kit with thermal compound
DRT-7-1	9756577	Rectifier , PRX IGBT block 200 AMP
DRT-8	9756589	Rectifier , PRX IGBT block 300 AMP kit with thermal compound
DRT-9	9717134	Rectifier , Toshiba IGBT block 100 AMP kit with thermal compound
DRT-10	147260, 9756553	Rectifier , PRX, 3PH kit with thermal compound
DRT-11	9717171	Rectifier , Toshiba IGBT block 150A kit with thermal compound
DRT-12	9717330	Rectifier , Toshiba IGBT block 200A kit with thermal compound (MIS-CHEM-002)
DRT-13	9756619	IGBT Block , 100 Amp @ 1200 VAC six pack drive block with thermal compound
DRT-13-1		IGBT Block , six pack 100 Amp, 1200VAC

S.E.E.S. #	O.E.M. #	Description
DMP-20	378AT2	Fan / Blower , extremely quiet, rugged construction. 115 VAC 550 CFM capacity, for mounting in any position, for Dover VVF Equipment

Resistors

S.E.E.S. #	O.E.M. #	Description
DRES-1	9752857, 75285	100 Ohm 10 Watt
DRES-2	9879857, 47985	5K Ohm 10 Watt
DRES-3	9884282, 68428	250 Ohm 5 Watt
DRES-3A	9805310	8 Ohm 50 Watt
DRES-4	9818522	1.8k Ohms 100 Watt
DRES-5	9818534	3.6k Ohms 100 Watt
DRES-6	9818546	50 Ohms 100 Watt
RES-29	9744400	10K Ohm 50 Watt
RES-38	9744332	50 Ohms 100 Watt
RES-39	9744344	100 Ohms 100 Watt
RES-40	9744319	250 Ohms 100 Watt
RES-42	9744356	500 Ohms 100 Watt
RES-44	9744368	1,000 Ohms 100 Watt
RES-50	9734107	1 Ohm 200 Watt
RES-53	9744423	10 Ohms 200 Watt
RES-54	9720467	25 Ohms 200 Watt
RES-55	9720479	50 Ohms 200 Watt
RES-55A	9720480	75 Ohms 200 Watt
RES-56	9720492	100 Ohms 200 Watt
RES-59	9744435	250 Ohms 200 Watt
RES-60	9744447	500 Ohms 200 Watt
RES-61	9744459	1,000 Ohms 200 Watt
RES-62	9720509	2.5 K Ohms 200 Watt
RES-63	9720583	5 K Ohms 200 Watt

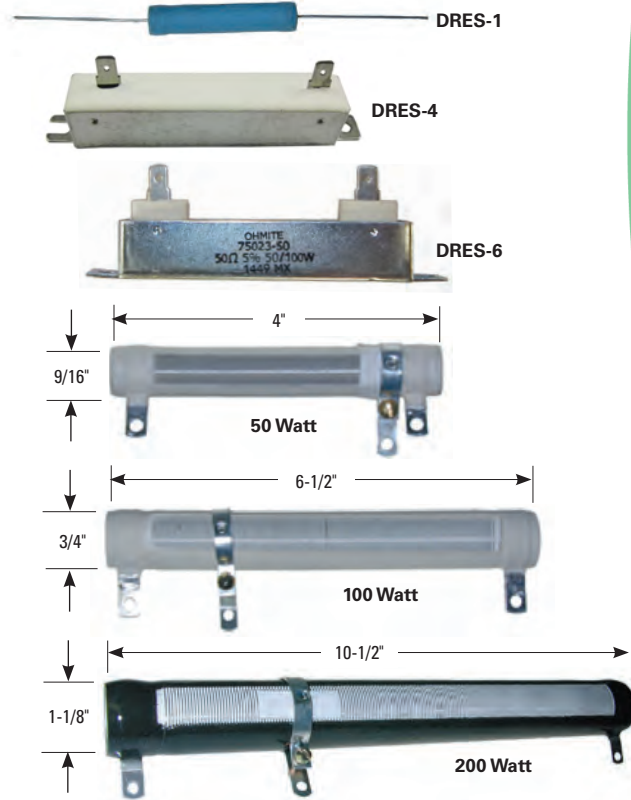

Relays

IBM Relays

S.E.E.S. #	O.E.M. #	Description
DRP-4	9791012, 109100	Relay, 32 VDC, 4 PDT
DRP-4S	769009	Solid State Replacement for DRP-4
PR-30	9767540, 76754, 769489	Relay, 48 VDC, 4 PDT
PR-30S		Relay, 48 VDC, 4 PDT W/LED solid state, alternate to PR-30
PR-30-S	769489	Relay, Solid State IBM 4 Pole 48 VDC
PR-31D	9756711	Relay, with diode arc suppressor, 45 VDC, 6 PDT
PR-31-S	769019	Relay, Solid State IBM 6 Pole 48 VDC
PR-33-S	186685	Relay, Solid State IBM 4 Pole Latching relay, 48 VDC
PR-34-S	769488	Relay, Solid State IBM 12 Pole
DRP-36	9787769	Relay, Card, G6B SPST 5A 690BX5
DRP-37	9718941	Relay, DC to AC T-4-IN



PR-30-S



PR-33-S



PR-31-S

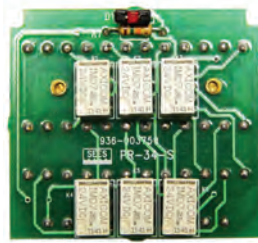

PR-34-S



DRP-36



DRP-37

Relays

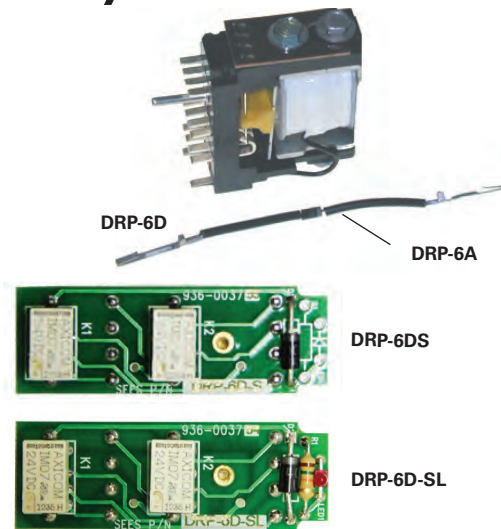

IBM Relays w/ Diode Arc Suppression

S.E.E.S. #	O.E.M. #	Description
DRP-6A	9856286, 65628, 9842081	Diode arc suppressor, diode with leads
DRP-6B	65261, 9852610	Diode assembly with leads for base
DRP-6D	9708960	Relay, with diode arc suppressor, 48 VDC, 4 PDT
DRP-6DS	9708960	Solid State Replacement for DRP-6D
DRP-6D-S	9708960	Relay, 4 PDT Solid State 48 VDC relay with Diode
DRP-6D-SL	9708960	Relay, 4 PDT Solid State 48 VDC relay with Diode & LED
PR-31D	9756711, 65671	Relay, with diode arc suppressor, 45 VDC, 6 PDT
PR-34D	9756723, 65672	Relay, with diode arc suppressor, 45 VDC, 12 PDT

IBM Relay Accessories

S.E.E.S. #	O.E.M. #	Description
PR-35	9767654, 76765, 159941	Receptacle, base for 4 PDT relay
PR-35C	9767678, 76767, 159942	Receptacle, base for 6 PDT relay
PR-35D	9767630, 76753, 159943	Receptacle, base for 12 PDT relay
PR-28-BC	9710322	Clip, bottom hold down clip for relay
PR-28-TC	9710310	Clip, top hold down clip for relay
PR-35A	149878	Contact, wire (not pictured)
PR-35L6	9702519	Jumper, insulated wire with taper pins 6" O.L.
PR-35L10	9702532	Jumper, insulated wire with taper pins 10" O.L.
PR-35L18	9702556	Jumper, insulated wire with taper pins 18" O.L.
PR-35T	9702611	Tool, for contact removal or insertion
MIS-301T		Universal Relay Tester For IBM style relays



DP Normally Open Front Connected Power Relays

S.E.E.S. #	O.E.M. #	Description
DRP-7	9769018, 76901	Relay with magnetic blowout, DPST, 48 VDC
DRP-14	9713256	Relay, DPST, N.O., 120 VAC
DRP-11	9768257	Relay, DPST, N.O., 24 VDC
DRP-8	9769020, 76902	Relay, DPST, N.O., 48 VDC
PR-101	9721733	Relay, DPST, 110 VDC
DRP-16	9753084	Relay with magnetic blowout, DPST, 6 VDC
DRP-13A	9909151	Relay with magnetic blowout, DPST, 12 VDC
DRP-14A	9741008, 71924	Relay with magnetic blowout, DPST, 120 VAC
DRP-12A	9740145, 72014	Relay with magnetic blowout, DPST, 110 VDC

Relays

DPDT Normally Closed Front Connected Power Relays

S.E.E.S. #	O.E.M. #	Description
PR-5	9752006, 75200	Relay , DPDT, 12 VAC
DRP-5A		Relay with magnetic blowout, DPDT, 48 VDC
PR-2	9768269, 76826	Relay , DPDT, 24 VDC
DRP-2	9768993, 76899	Relay , DPDT, 48 VDC
PR-7	9713207, 71922	Relay , DPDT, 120 VAC
PR-3	9713360, 72015	Relay , DPDT, 110 VDC
PR-9	9713219, 71923	Relay , DPDT, 240 VAC
DRP-13	9776357, 9776345	Relay with magnetic blowout, DPDT, 12 VDC
DRP-15	9755240, 75524	Relay with auxiliary contacts, DPDT, 120 VAC



DRP-5A



DRP-9



DRP-13

Field Protection Relay

S.E.E.S. #	O.E.M. #	Description
DRP-21	9764010, 76401 9769092	Field Protection Relay , current sensitive, pull in .75 amps, drop out .3 amp, operate 25.0 amp
DRP-9	9741884	Reverse Phase Relay , 440 VAC
DRP-9A	9834612	Reverse Phase Relay , 220 VAC
DRP-9B	9832555	Relay Monitor , reverse phase, 230 VAC



DRP-21



DRP-9A



DRP-17



DRP-18B



DRP-18E

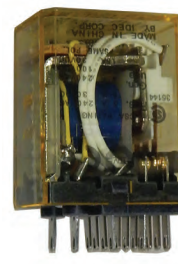

DRP-200



DRP-19A

DPDT 10 Amp Plug-in Relays

S.E.E.S. #	O.E.M. #	Description
DRP-17	9728648, 9783398, 132909	Relay , DPDT, 24 VDC, with diode
DRP-18	9832427, 9811060, 132426	Relay , DPDT, 110 VDC, with diode
DRP-18A	9783295, 132908	Relay , DPDT, 12 VDC, with diode
DRP-18B	9791061	Relay , 4PDT, 24 VDC, with diode and LED
DRP-18C	9811060	Relay , 4PDT, 110 VDC, with diode
DRP-18E	RH2B-ULC-AC120	Relay , DPDT, 10A, 120 VAC
DRP-19S		Relay , 6PDT, 48 VDC, Solid State
DRP-19A	9719970, 171AH1	Relay , DPDT, 48 VDC with push to test and lamp
DRP-19B	9953887	Relay , DPDT with diode, 48 VDC
DRP-19C	9951854	Relay , 110 VDC, DPDT w/ Neon Indicator
PR-102SS	HG2-SS	Socket , solder terminal for DP relay
DRP-200	9954922	Relay , 4PDT, 120 VAC
DRP-201	9954922	Relay Finder , 24 VDC



DRP-19S

■ 3/16" quick connect terminals for plug-in socket capability



DRP-19B



PR-102SS

Relays

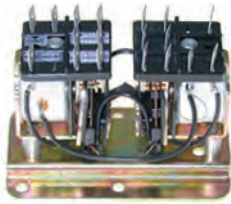

DRP-1



DRP-22



DRP-22F



DRP-22J

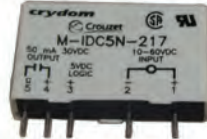

DRP-22K



DRP-25



DRP-26

Dual Coil Mechanical Latching Relay

S.E.E.S. #	O.E.M. #	Description
DRP-1	9724140	Latching relay, 2 sets 3 PDT, 240 VAC, door reverse function
DRP-10	9753047, 9813809	Latching relay, 2 sets 3 PDT, 120 VAC, door reverse function

S.E.E.S. #	O.E.M. #	Description
DRP-22	9853352, 518AC1	Output module, 24 VDC, black
DRP-22A	9851847, 518AF1	Output module, 200 VDC, black
DRP-22B	9853340, 518AB1	Input module, 90 VAC to 140 VAC, black
DRP-22C	9853339, 518AA1	Input module, 10 VDC to 32 VDC, black
DRP-22D	9853364, 518AD1	Output module, 120 VAC, black
DRP-22E	9719349, 518AK1	Output module, 280 VAC, black
DRP-22F	9719374, 518AJ1	Output module, 60 VDC, red
DRP-22G	9719362, 518AH1	Input module, 90 VAC to 140 VAC, yellow
DRP-22H	9719350, 518AG1	Input module, 10-48 VDC, white
DRP-22J	9852931	Module, I/O, DC Output 10-200V 4-Pin
DRP-22K	9809820	Module, I/O, DC Input 18-60V 5-Pin

DRP-25	9723780	Relay, 2P, 12V
DRP-26	9708091	Relay, 2P, 24V
DRP-27	9953711	Relay, IDEC 24 VDC
DRP-29	9840643	Relay, O/L, 45-90 Amp manual reset
DRP-35	9782195	Overload Relay, Solid State



DRP-27



DRP-29

Contactors



DRP-23



DRP-24



DRP-32



DRP-31

A.C. Reversing Contactor

S.E.E.S. #	Description
JC-7	Reversing contactor, 208-240 VAC, 50-60 Hz, 160 pick up volts, 680 ohms resistance D.C. 6" L, 3-3/4" W, 3" H with auxiliary contact

■ This reversing contactor is mechanically and electrically interlocked for low cost motor reversing applications. It is the first choice for door open/close function because of its proven reliability. Standard assembly includes mechanical interlock with four SPDT auxiliary contacts for electrical interlocking. Mounting bracket allows for easy installation. Double 1/4" quick connects on each coil terminal and easy access quick connects on right hand contactor with screw terminals on left hand contactor assure installation ease.

A.C. Contactor

S.E.E.S. #	O.E.M. #	Description
DRP-23	9853110	Contact, 4 Pole N.O. 24A, 120 coil for TIII
DRP-24	9837243	Relay, reversing, square "D" 120 VAC
DC-21	9817475	Contact, 3 Pole, 18.5KW, 400 VAC, 30 HO
DRP-31	9738289	Relay Part, for Overload heater
DRP-32	9722713	Contact, 3 Pole Siemens 42EF35AF
DRP-32B	298AG2	Interlock, Mechanical

Contactors

D.C. Contactor and Components

FOR #14 AND #15 SWITCHES, 100 AMPS AT 12VDC

S.E.E.S. #	O.E.M. #	Description
DRP-20	9871184, 77118	Contactor , 48 VDC coil, Single pole, double throw, make before break contacts, for #15 Switch
DRP-20A	9871196, 77117	Contactor , 48 VDC coil, Single pole, double break contacts, for #14 Switch

S.E.E.S. #	O.E.M. #	Description
DRP-20B	35893	Moving core
DRP-20C	35902	Guide , core
DRP-20D	36926	Fixed core
DRP-20E	10150	Core tube
DRP-20F	10152	Bushing for core tube
DRP-20G	35892	Guide stud
DRP-20H	35891	Bolt for movable assembly
DRP-20I	10074	Cradle block
DC-15	9759001	Stationary contact , normally closed
DC-16	9758902	Movable contact
DC-17	9759098	Stationary contact , normally open
DC-18	9758872	Spring , contactor, 8 turns
DC-19	9758884	Spring , contactor, 6 turns
DCO-4	9758940	Coil , 48 VDC. 1" I.D. x 2" O.D. x 2" L. Replacement coil for #14 & #15 Switches



Starter Assembly

S.E.E.S. #	O.E.M. #	Description
DPC-117	9747333	Starter assembly , Size 2-3, Y-MS, used on 147283 contactor

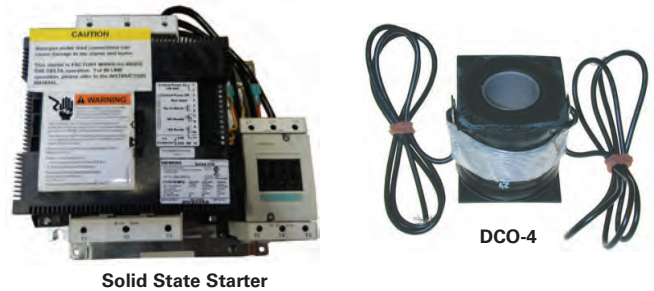

Solid State Starters

Selection Guide

S.E.E.S. #	O.E.M. #	Hydro 200V	Traction 200V	Hydro 220V	Traction 220V	Hydro 230V	Traction 230V	Hydro 380/400V	Traction 380/400V	Hydro 415V	Traction 415V	Hydro 460V	Traction 460V
MIS-NOR-004	9739040	5-15 HP	5-10 HP	5-15 HP	5-10 HP	5-20 HP	5-15 HP					5-40 HP	5-30 HP
MIS-NOR-005	9739051	20 HP	15 HP	20 HP	15 HP	25 HP	20 HP	40 HP	30 HP	40 HP	30 HP	50 HP	40 HP
MIS-NOR-007	9739087	25-30 HP	20-25 HP	25-30 HP	20-25 HP	30-40 HP	25-30	50 HP, 60 HP	40 HP, 50 HP	50 HP, 60 HP	40 HP, 50 HP	75 HP	60 HP
MIS-NOR-008	9739099	40 HP	30 HP	40 HP	30 HP	50 HP	40 HP	75 HP	60 HP	75 HP	60 HP	100 HP	75 HP
MIS-NOR-009	9739129	50 HP	40 HP	50 HP	40 HP	60 HP	50 HP			100 HP	75 HP	125 HP	100 HP

For additional Solid State Starters, see page 301.

Safety Edge Equipment

Item	S.E.E.S. #	O.E.M. #	Description
1	DSE-4	9873971, 47397	Auxiliary mounting arm
2	DSE-5	9874136, 120854	Switch assembly, L.H. for safe edge
	DSE-5A	9874586, 120853	Switch assembly, R.H. for safe edge
	DSE-6	9775535, 47553	Micro Switch, BZ-2RD-D82, quick connect
	DSE-6A	9750447	Micro Switch, BZ2RS-A2
	DSE-6B		Bracket for Micro Switch
	DSE-6C	9775535	Micro Switch, BZ-2RD-A2, screw terminal
3	DSE-8	9701461, 40146	Retractor spring
4	DSE-1B	44693	Mounting strip, steel
5	DSE-13	9851320	Spacer
6	DSE-14	9861415, 66141	Bumper
7	DSE-1S	9701837	Stiffener, 81-3/4" long U channel
8	DSE-3	9818248, 118249	Actuating arm assembly
9	DSE-3A	9801110, 40111	Shaft, roller pin for DSE-3 Actuating arm assembly
	DSE-15A	9732548, 77008	Bearing rod end, R.H.
10	DSE-15B	9732550, 77009	Bearing rod end, L.H.
11	DSE-16	102208	Screw, hex head 3/8-24 x 1-3/4" L
12	DDO-30	9747035, 44703	Rod attachment
	DSE-7	9774087, 47408	Ball bearing
	DSE-2	9735963, 100848	Retainer, Socket head screw
	DSE-12	9874392, 47439	Nut, Safety edge mounting arm nut, outer, on DSE-3
	DSE-11	9874045, 47404	Nut, Safety edge mounting arm nut, inner, on DSE-3
13	DSE-1L	9822276, 122217	Rod link, 21", R.H. & L.H.
14	DSE-17		Cable, 4 conductor, 18 gauge
	DSE-15	9701849	Rod, connecting rod assembly for Safety Edge 63899 Older Style. (Not DSE-9, DSE-10, pictured here)

SEES Light Curtain

S.E.E.S. #	Description
SEES-SCREEN-001B	SEES Screen II, Light Curtain, blue/red combo, 120 VAC
SEES-SCREEN-001G	SEES Screen II, Light Curtain, green/red combo, 120 VAC
SEES-SCREEN-001N	SEES Screen II, Light Curtain, Door Edge with Nudging Power Supply
SEES-SCREEN-001NC	SEES Screen II, Nudging Power Supply Only
SEES-SCREEN-001C	SEES Screen II, 120 VAC Controller Only
SEES-SCREEN-001R	SEES Screen II, Receiver Only
SEES-SCREEN-001T	SEES Screen II, Transmitter Only
SEES-SCREEN-001-MOVFR-CH	SEES Screen II, Light Curtain Direct Connect MOVFR, with Chip
SEES-SCREEN-001-MOVFR	SEES Screen II, Light Curtain Direct Connect MOVFR, without Chip
SEES-SCREEN-002	SEES Screen II, Light Curtain Waterproof
SEES-SCREEN-002N	SEES Screen II, Light Curtain Waterproof, with Nudging

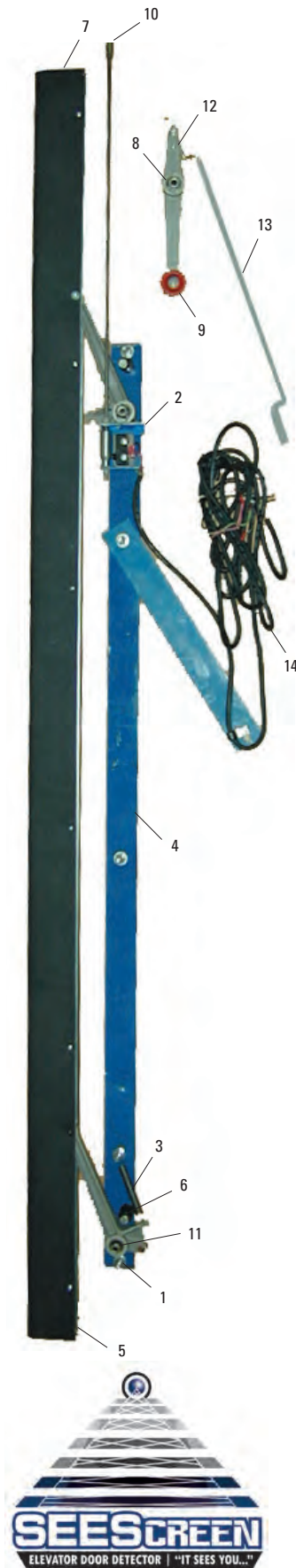

Safety Edge Equipment

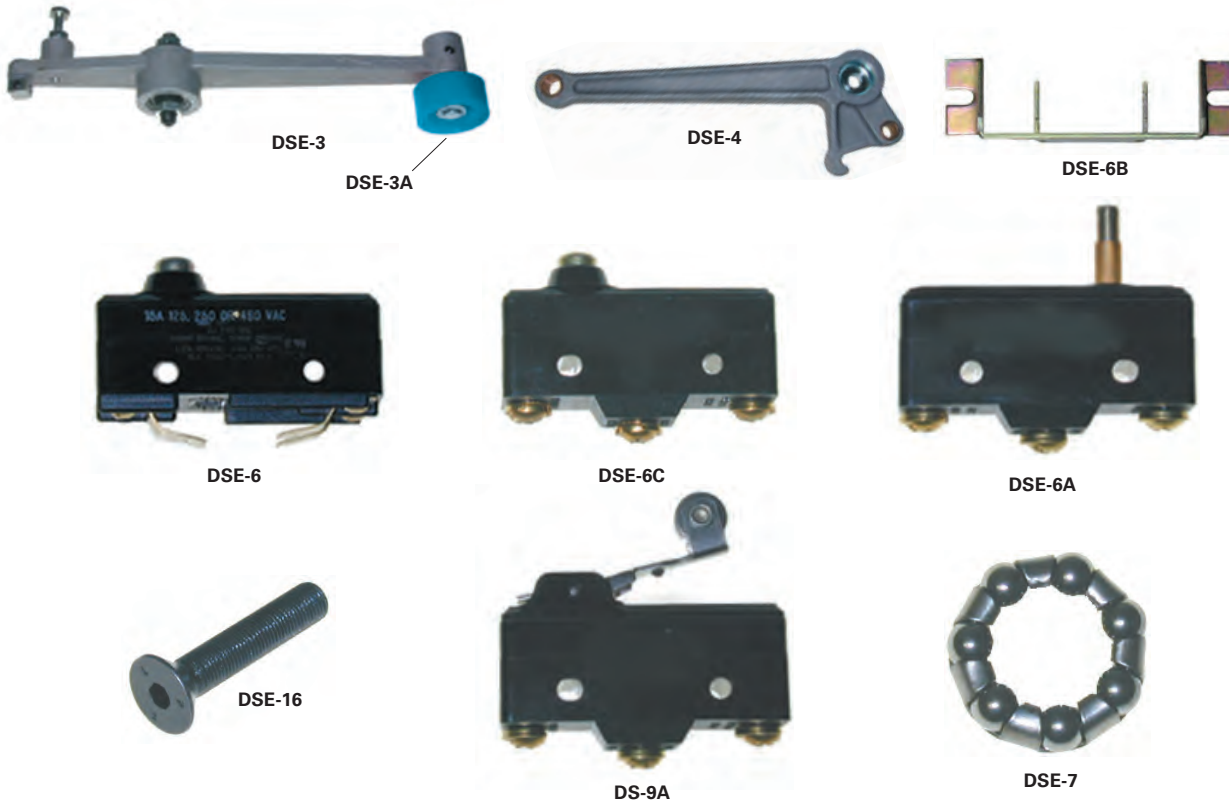

S.E.E.S. #	O.E.M. #	Description
DSE-3	9818248, 118249	Actuating arm assembly
DSE-3A	9801110, 40111	Shaft , roller pin for assembly
DSE-4	9873971, 47397	Auxiliary mounting arm
DSE-2	9735963	Screw , retainer 1/4-20, for DSE-4
DSE-13	100549	Spacer , for DSE-4
DSE-6	9775535, 47553	Micro Switch , BZ-2RD-D82, quick connect
DSE-6C	9775535	Micro Switch , BZ-2RD-A2, screw terminal (original version)
DSE-6A	9750447	Micro Switch , BZ-2RS-A2
DSE-6B		Bracket , for Micro Switch
DSE-16	102208	Screw , hex head 38-24 x 1-3/4" L used in conjunction with DSE-4
DS-9A	9758896, 75889	Micro Switch with arm and roller for safety edge
DSE-7	9774087, 47408	Bearing , for DSE-3 and DSE-4 ball bearing for pivot arms
DSE-8	9701461, 40146	Retractor spring
DSE-11	9874045	Nut , for safe edge inner arm
DSE-12	9874392	Nut , for safe edge outer arm
DSE-13	100549	Spacer , for stiffener, 1/4-20 internal threaded for DSE-2 screw
DSE-14	9861415, 66141	Bumper , eccentric rubber bumper



Selector Parts

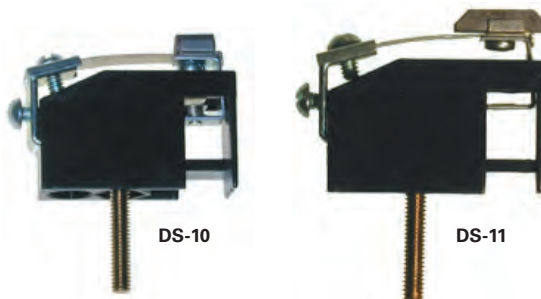
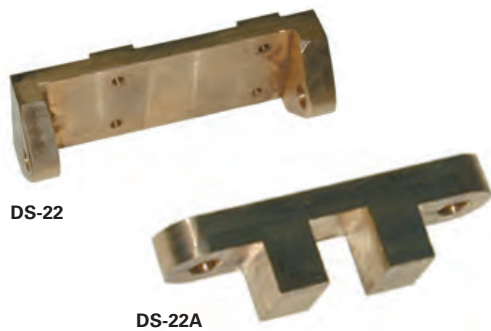
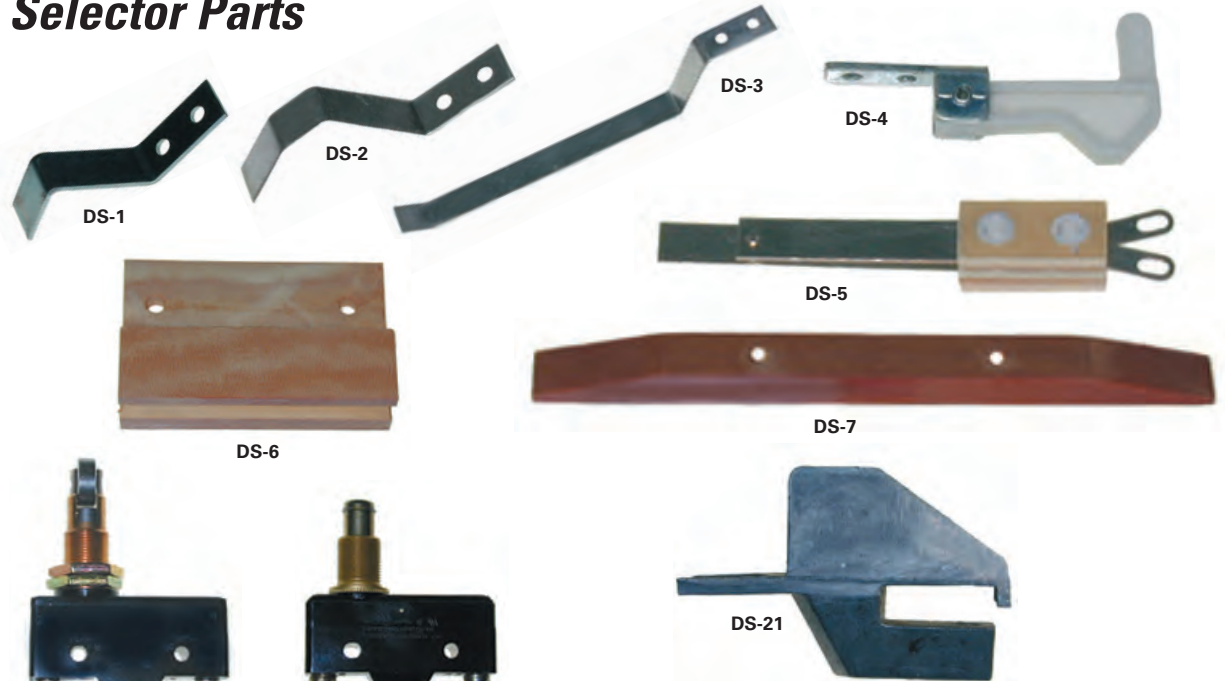

S.E.E.S. #	O.E.M. #	Description
DS-1	9722191, 22219	Short contact , 2-19/64" x 1/2"
DS-2	9722415, 22241	Medium contact , 2- 51/64" x 1/2"
DS-3	9722233, 22223	Long contact , 6-1/8" x 1/2"
DS-4	9748672	T.M. Switch actuator cam assembly for screw type selector
DS-5	9870556, 77055	T.M. Switch contact assembly with silver contacts
DS-5A	9889474, 68947	T.M. Switch assembly includes DS-4 and DS-5
DS-6	9772087, 22206	Guide for channel type selector, 3" x 2" x 7/8" with 3/8" slot, made of durable canvas base phenolic
DS-7	9822264, 22226	Cam for channel type selector, 6-3/8" Long
DS-8	9870570, 77057	Micro Switch , roller activated for carriage assembly on screw type selector
DS-9	9715642, 71565	Micro Switch for channel type selector
DS-10	9748623, 64862	Direction Switch , 5/16" L carbon contact and breaking silver to silver contacts, for floor bar assembly on screw type selector
DS-11	9848617	Brush Switch , 21/32" L carbon contact, (no silver contacts) for crosshead on screw type selector
DS-21	9846086, 41416	Selector clamp , aluminum, for microswitch
DS-22	9765645	Bracket , leveling ring mounting bronze bracket
DS-22A	102184	Bracket , lower leveling ring mounting bronze bracket
CKDS-1	101335	Contact Kit , Carbon Replacement For DS-11, 12 & 13

Selector Parts

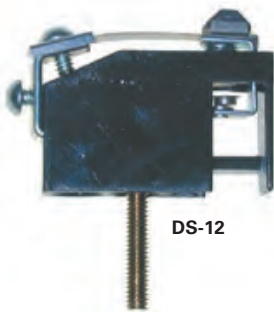

DS-12



DS-13



DS-14



DS-14A



DS-15



DS-15A



DS-16B



DS-17

S.E.E.S. #	O.E.M. #	Description
DS-12	9848539	Brush Switch assembly , 5/16" L carbon contact with breaking silver to silver contacts, for crosshead on screw type selector
DS-13	9848605	Brush Switch assembly , 5/16" L carbon contact, (no silver contacts) for crosshead on screw type selector
DS-14	9871317	Make break contact assembly , used on carriage assembly on screw type selector
DS-14A	9714390, 41439	Spring , bronze kick-off spring, 9/16" O.D. x 1"
DS-15	41424	Carbon plunger with 8-32 threaded brass stem, 2-3/4" L
DS-15A	9856791	Reset contact assembly complete
DS-16	D-320, 9763673	Leveling cam
DS-16B	9763636, 106363	Cap for leveling cam
DS-17	9813895, 41388	Leveling cam for 100:1 ratio, screw type selector, 300 feet, max. travel
DS-17B	9822446	Interlock Conversion Kit , Center Opening
DS-18	9714339, 41433	Floor bar contact used for screw type selector, 1-3/8" L with 8-32 thread
DS-18A	9714376, 41437	Contact insulator (back)
DS-18B	9714364, 41435	Contact insulator (front)
DS-18C	9950862, 41436	Contact insulator
DS-18D	9950837	Contact insulator , mount
DS-19	9722038, 22205	Washer , phenolic 5/8" O.D. x 1/4" I.D. x 1/8"
DS-48	9870179	Sensor , Optical 10-30 VDC Fiber Optic 10" Leads

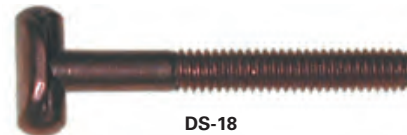

DS-18



DS-18A



DS-18B



DS-18C



DS-18D



DS-48

Selector Parts

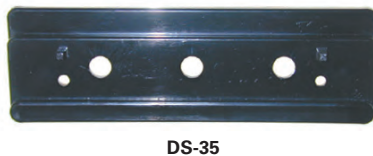
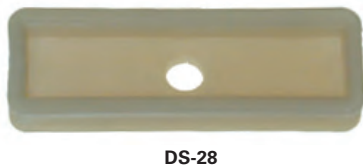

S.E.E.S. #	O.E.M. #	Description
DS-20C	9729045	Carbon ski contact 3-1/2" replacement contact for conducting butt brush assembly, used on assembly 9729045
DS-20D	9729057	Carbon ski contact 3-1/16" replacement contact for insulated butt brush assembly, used on assembly 9729057
DS-20	9879092, 9856833	Position Indicator brush assembly with insulated butt, brass surface
DS-20A	9897719	Position Indicator brush assembly conducting butt, brass surface
DS-23	9823360, 102336	Switch assembly , long, 11/16" carbon contact
DS-24	9813380, 101330	Switch assembly , short, 5/16" carbon contact
DS-25	9768932, 68932	Cable assembly , 36 conductor ribbon cable, 122" L, with quick connect plugs each end
DS-27	114104	Flat cable , 18 conductor ribbon cable, 96" long with pins
DS-26	106328	Pivot for selector guide shoe
DS-28	9842068	Crosshead guide shoe 2-1/4" L x 3/4" W
DS-29	9859998, 65999	Cam , direction selector
DS-30	9841441	Leveling guide
DS-31	9870600, 77060	Bearing , flange 1-1/4"
DS-32	9870593, 77059	Bearing , flange 3/4"
DS-35	9841544	Selector tape guide , 4" L x 1-1/4" W, plastic, Sold Separately
DS-35A		Selector tape guide , Brass, Heavy Duty version of DS-35. Sold Separately
ES-001	9745312	Vane Magnetic Selector tape , ELGO Selectors, Absolute Positioning for Dover/Thyssen

Selector Parts



S.E.E.S. #	O.E.M. #	Description
DS-33	9763818, 68953	Switch assembly , slack cable
DS-33A	127595	Contact , stationary for DS-33
DS-34	9847730, 66354	Idler sheave , 5-1/2" O.D. x .6693" I.D. for 1/8" cable, MIS-300
DS-34A	9847730, 66354	Idler sheave assembly 5-1/2" O.D. with bracket and hardware (DS-34 and 34B)
DS-34B	26743	Bracket for idler sheave
MIS-300	9871421	Cable , 1/8" galvanized, for DS-34 7 x 19 strand
DS-36	9829430	Pressure spring , 15-1/2" L x 7/8" O.D.
DS-37	9722270	Contact
DS-37A	9722026	Holder , contact insulator
DS-38	9881396, 28139	Cam
DS-39	9840795, 44079	Composite selector pinion
DS-39A	9875438	Gear , pinion, 48 tooth, 100:1
DS-40	9814437	Selector Traveling Nut and HDW
DS-41	9814477	Bearing , Linear Selector
DS-42	9811230	Selector Lead Screw , 53", works w/ DS-41
DS-43	141618	DMC Selector tape , .032" x 3" W 141618
DS-44	9810078	DMC Magnet Strip , 2-1/2" L 141077
DS-45	9741070	DMC Magnet Strip , 8" L 141078
DS-46	9853388	Magnet Strip , 12" 568AA1
DS-47	9864672	Toggle Switch , Carling
ES-001	9745312	Vane Magnetic Selector Tape , ELGO Selectors, Absolute Positioning for Dover/Thyssen



DS-44



DS-45



DS-46

Transformers



DTR-1



DTR-6



DTR-7



DTR-9



DTR-10



DTR-11



DTR-13

S.E.E.S. #	O.E.M. #	V.A.	Primary Volt.	Secondary Volt.
DTR-1	9768658, 76865	150	230/460	24/48
DTR-2	9720972, 71545	250	230/276	120/230
DTR-2A	9706562, 129826	250	230/460	115/230
DTR-2B	9829829, 129827	250	230/460	24/48
DTR-3	9767848, 76784	250	230/460	35
DTR-4	9716725, 75199	500	230/460	115/230
DTR-5	9716890, 77073	750	230/460	115/230
DTR-6	9745956, 74595	1000	230/460	115/230
DTR-7	9779309, 77930	602.5	120/133/139/266/277	34.4/183
DTR-8	9779310, 77931	1182	120/133/139/266/277	93/35
DTR-9	9786971, 108697	715	200/230/240/460/480	48/24
DTR-10	9882248, 78224	1190	200/230/240/460/480	38.5/115
DTR-11	9882250, 78225	685	200/230/240/460/480	38.5
DTR-12	9871305, 77130	100	230/460	115
DTR-13	9737480	200	240/480	120/240
DTR-14	9781916, 102834	690	230/550/575/600	38.5
DTR-16	9786960	815	208/480	115
DTR-17	9754378		Transformer, PWR 1PH .5KVA -MX	120/240

Valve Components



DV-1



DV-2



DV-2A



DV-3



DV-4



DV-5



DV-6



DV-200



DV-202



DV-203



S.E.E.S. #	O.E.M. #	Description
DV-1	9788566, 28856	Solenoid seat , N.C. for up and down pilot sections, brass, 5/8" O.D. x 5/8" L with O-ring, for 9715060 plunger and needle assembly
DV-2	9788554	Solenoid seat , N.O. for 63426 and 3431 up pilot sections, steel, 5/8" O.D. x 5/8" L, for 9715060 plunger and needle assembly
DV-2A	9724722	Solenoid seat
DV-3	9731143, P150-24	Regulator spring , 11/16" O.D. x 5-3/4" L, 27 turns
DV-4	9807524, P149-7	Washer spring seat for 9731143 regulator spring, brass 11/16" O.D. x 5/8" L with steel pivot ball
DV-5	9730904, P14915	Regulator control piston for 63427 and 63432 down pilot sections, Delrin piston, 1/2" O.D. x 1-5/8" L
DV-6	9754076, 76407, 63432	Orifice control piston for 63427 and down pilot sections Delrin piston, 1/2" O.D. x 1-5/16" L
DV-201	9712112	O-Ring , for Valve P Series, #0 1.18" x 1.0625"
DV-202	9779700	Nipple NPT , Pipe, 1/8" x 1" Lo Valve and EP Power Units
DDO-51	9815855	Solenoid, Brake, Retrofit Kit , G4 & G5 w/ Armatures, sleeve & nameplate for 150 VDC 205AV1 Solenoid
DDO-52	9815818	Solenoid, Brake, Retrofit Kit , GD1, Single Solenoid, with armature, sleeve, plates, dustcover & nameplates for 140 VDC 799AE1 solenoid
DDO-53	9815806	Solenoid, Brake, Retrofit Kit , Geared Single Solenoid, w/ armature, sleeve, plates, dustcover & nameplates for 140 VDC 126689 solenoid
DV-200	9754672	O-Ring , for Valve P Series, #0 1.18" x 1.0625"
DV-200A		Coil , Solenoid Kit, 120 VAC with Plate & Nut
DV-203		Telescopic Jack Check Valve

Valve Components

Springs for Pistons on Lowering and Constant Speed Lowering Sections

S.E.E.S. #	O.E.M. #	Description
DV-7	9730254, P12533	Spring, 2-1/8" O.D. x 4-1/4" L, 5-3/4 turns
DV-8	9730760	Spring, 1-11/16" O.D. x 3-3/4" L, 6 turns
DV-9	9730564, P12579	Strainer assembly for up and down pilot sections, 7/8" hex brass body with strainer screen and O-ring
DV-10	9805590, P125139	Assembly needle valve manual for down pilot sections
DV-10A	9715060, P56431	Plunger and needle valve for Pilot Solenoids
DV-11A	9730590, P12592	Control piston spring, 7/16" O.D. x 1-1/16" L
DV-11B	9754064, 75406	Orifice spring, 1/4" O.D. x 1-3/4" L
DV-12	9861610, 66161	Assembly needle valve for up and down pilot sections
DV-13	9730576, P12590	Control piston for up and down section, steel piston 1/2" O.D. x 1-3/4"
DV-46	9724709	Gasket, Tube Valve Pilot Solenoid
DV-47	9897227	Valve, Integral Valve
DV-48	9842007	Valve, I-3
DV-100	9722282	Washer, Insulated, 2-1/4" Diameter
DV-100A	100010	Post Insulating Bushing used w/ SEES DV-100
DV-102	9729124, 9781456	Adjuster Leveling Kit, I-1 & I-2 Valve, with "O" rings
DV-103	9729525	Adjuster Leveling Kit, I-3, with "O" rings
DPAC-31D	9824467	Strainer Assembly, Valve 1-2, .3125" Diameter, Stainless Steel

Valve Coils

S.E.E.S. #	O.E.M. #	Description
DV-15	9715563	Solenoid coil, 115 VAC, I.D. 3/4", O.D. 2-3/4", 2-1/8" L, 1386 Coil
DV-15A	9803452	Solenoid coil Kit, 120 VAC with Flux Plate & Nut
DV-16	9753965, 75396 9715575, 9755895	Solenoid coil, 115-230 VAC, I.D. 3/4", O.D. 2-3/4", 2-1/8" L, Coil 1224
DCO-5	9722300	Coil, works with I-2 & I-3 Valves, 120 VAC, I.D. 1/2", O.D. 1-1/4", 1-1/4" L
DCO-6	9768981	Coil, 24 VDC, I.D. 7/8", O.D. 1-7/8", 1-7/8" L

Valve Springs

S.E.E.S. #	O.E.M. #	Description
DV-27	9730163	Spring, 3/4" O.D. x 2-3/4"
DV-28	9730140	Spring, 3/4" O.D. x 2-3/8"
DV-29	9730151	Spring, 3/4" O.D. x 2-3/8"

Silencer Components

S.E.E.S. #	O.E.M. #	Description
KHM-001	9817843, USP12000/USP12000019	Muffler, 2" x 2" x 18.5" Pancake Style Muffler, Grooved
KHM-002	9726731	Muffler, 2" Submersible
DV-34	9848836, 44883	Core, with springs for muffler for 2" and 3" Silencer



Valve Components



DV-24



DV-37

DV-40

DV-44

Wheels and Rollers

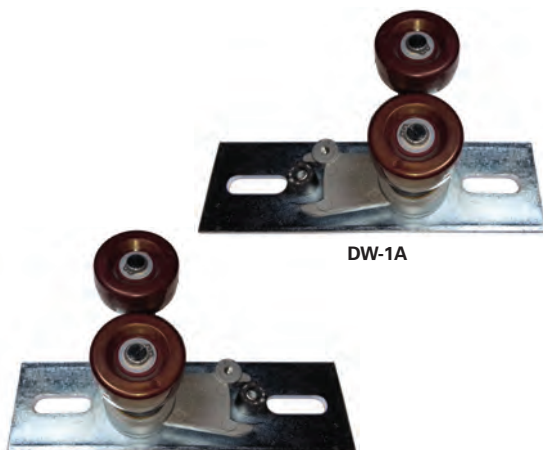

DW-1A

DW-1A-R



DW-1

S.E.E.S. #	O.E.M. #	Description
DV-24	9754179	Repair Kit , Gasket/O-ring repair kit, for P125 and P126 Valve
DV-25	9754179	Repair Kit , O-ring repair kit, for 60,000 series oildraulic
DV-26	9708327	Repair Kit , Gasket/O-ring repair kit, for 60,000 series/lowering-down
DV-30	9732860	Repair Kit , Gasket/O-ring repair kit for I-2 Valve
DV-30A	9720911	Repair Kit , Gasket/O-ring repair kit for I-3 Valve
DV-35	9723067	Seal , neoprene valve seal P-144-5

* See more seals starting on pg 390.

Valve Gaskets, O-Rings, Repair Kits

S.E.E.S. #	O.E.M. #	Description
DV-17	9707750	Gasket
DV-18	9708108	Gasket
DV-19	9708145	Gasket
DV-20	9724941	Gasket
DV-22	9708169	Gasket
DV-23	9731260	Gasket
DV-21	9709733	O-Ring
DV-31	9709861	O-Ring
DV-32	9709903	O-Ring
DV-33	9754647	O-Ring
DV-36	9742943	O-Ring
DV-37	9754660	O-Ring
DV-38	9709812	O-Ring
DV-39	9709836	O-Ring
DV-40	975470	O-Ring
DV-41	9754635, 75463	O-Ring
DV-44	9754659	O-Ring , for I-2 Valve, 13/16" x 15/16"
DV-45	9754817	O-Ring , 3.375" O.D. x 3.125" I.D.

S.E.E.S. #	O.E.M. #	Description
DW-1A	9875256, 47525	Pick-up roller assembly , 1-5/8" dia., polyurethane rollers with a STEEL mounting base. Assembled L.H. (interchangeable L.H. or R.H.)
DW-1A-R	9875268, 47525	Pick-up roller assembly , as above. Assy R.H. (interchangeable R.H. or L.H.)
DW-1	9838351, 63835	Replacement roller kit for door pick-up roller assembly 1-5/8" dia., polyurethane with bronze bushing, nylon washers and retaining ring

Wheels and Rollers

S.E.E.S. #	O.E.M. #	Description
DW-1B	9897641, 29764	Steel base for pick-up roller assembly
DW-1C	9736141, 70115	Retaining ring for DW-1
DW-1D	9801157	Shaft for DW-1 pick-up rollers
DW-1E	9838181, 47529	Roller crank
DW-1F	9759268, 75926	Retaining ring for 1" shaft
DW-1H	9870052	Bumper, for Door Pick Up Assy DW-1A, DW-1A-R
DDO-42	860AE14	Car Door Hanger Rail 98" Dover, "J" (no holes)



DW-1F



DW-2

S.E.E.S. #	O.E.M. #	Description
DW-2A	9838340	Hanger assembly, low pocket, consists of mounting bracket DW-2B, hanger roller DW-2, and eccentric upthrust shaft DW-9, with roller tire assembly DW-10
DW-2	9838302, 63830	Hatch door hanger roller, .6693" I.D. aluminum with polyurethane tires, 2-7/8" dia.
DW-2B	9752249	Frame, low pocket hanger
DW-2C		Hanger Assy Rebuild Kit, Low Pocket Hanger
DW-3A	9838533	Hanger assembly, high pocket, consists of mounting bracket DW-3B, hanger roller DW-3, and eccentric upthrust shaft DW-9, with roller tire assembly DW-10
DW-9	9752160	Eccentric upthrust shaft, 3/4" x 1-3/8" L, used with DW-10, 1/8" shoulder
DW-9A	9861191	Eccentric upthrust shaft, 1-3/8" O.D.
DW-10	9875426, 67542	Roller tire assembly, for DW-9
DW-10A		Bearing, 5/8" I.D. x 3/4" L (heavy duty replacement for DW-10)
DW-3	9864295	Hanger roller, .6693" I.D., steel with polyurethane tire, 3-5/16" diameter
DW-3B	9752158	Frame, high pocket hanger



DW-1B



DW-1D



DW-1E



DW-2A



DW-2B



DW-10



DW-3A



DW-10A



DW-9



DW-9A



DW-3



DW-3B

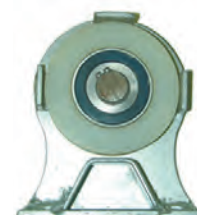

DW-5



DW-5A



DW-6A

Sheave and Bracket Assembly

S.E.E.S. #	O.E.M. #	Description
DW-5	9811102, E40034	Sheave and bracket assembly, for vertical gate
DW-5A		Sheave, 3.275" O.D. x .750" I.D. for DW-5 sheave assy.
DW-6	9831873, 63187	Roller guide wheel, 4" O.D. x 3/4" W, single bearing, .6693" I.D., 1/2" tire face
DW-6A	29253	Eccentric shaft for roller guide wheel DW-6
DW-6H	D421, 9831873	Roller Guide Wheel, 4" O.D. x 3/4" W x .6693" I.D., HD 90 Duro
DW-7	9872309	Counterweight roller guide, 3" O.D., 13/16" W, bearing .7874"
DW-7S		Counterweight roller guide, 3" O.D., 13/16" W, bearing .7874", soft poly



DW-6

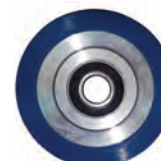

DW-6H



DW-7



DW-7S

ESCO

QUICK LOCATOR GUIDE

Relays	604
Capacitors	604
Timers	604
Selector Parts	604
Striker Assemblies.....	604
Tape Guide Assembly.....	604
Stepper Wheel.....	604
Blade Spring.....	604
Cams.....	604
Packing Set	605
Switches	605
Transformers	606
Wheels and Rollers	606
Hanger Rollers.....	606
Guide Wheels.....	606

Relays

S.E.E.S. #	O.E.M. #	Description
MIS-206		Capacitor, 124-149 MFD, 330 VAC
PR-107S		Socket, octal 12 pin, tube type
PR-108		Relay, latching 240 VAC 12 pin Octal
PR-109	RTE-P21-AC120	Relay, off delay, timing, 120 VAC, 11 pin round, 1sec-10min
MIS-231		Plug in, Freeman timer kit #17>31

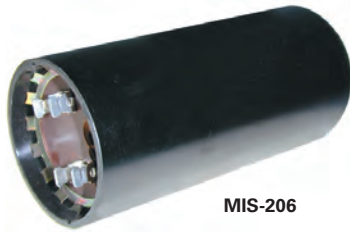

MIS-206



PR-108



PR-109



MIS-231



MIS-217



MIS-218

Selector Parts

S.E.E.S. #	O.E.M. #	Description
MIS-217	3-410-001	Single Striker Assembly
MIS-218	33-410-007	Dual Striker Assembly
MIS-224B		CAM, for ESCO selector
MIS-227	3-364-029	Cam, R.H.
MIS-228	3-364-029	Cam, L.H.
MIS-219	0013-016-031	Tape Guide Assembly
MIS-229	3-010-027	Spring Selector, 7" center to center
MIS-230	3-070-014	Selector tape, 1/2" W x .020" T
MIS-224	3-021-004	Stepper Wheel, for selector
MIS-224A	3-00379-003	Stepper Wheel, 6 point
MIS-234	3-034-034	Selector Cam, 1 lobe for 7A selector
MIS-235	3-034-035	Selector Cam, 6 lobe for A7 selector
MIS-236	3-614-001	Selector Blade Spring, ESCO A-Selector



MIS-224B



MIS-227



MIS-219



MIS-229



MIS-230



MIS-224



MIS-224A



MIS-234



MIS-235

Packing

S.E.E.S. #	O.E.M. #	Description
DPAC-20A	3EA024-04	Packing Set , consists of 2 seals and a lantern Ring, for 4-1/2" plunger size

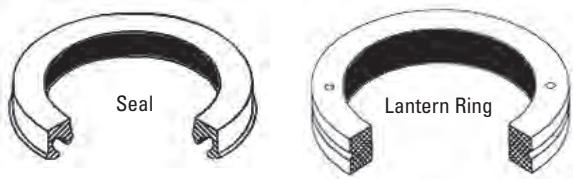

Switches

S.E.E.S. #	O.E.M. #	Description
MIS-232	3-376-159	Micro Switch , SW 4A8M
MIS-232A	3-376-051	Micro Switch , for A5 & A6
MIS-232B	3-376-129 3-376-130	Micro Switch , for A7, A8, & 8D



Transformers



MIS-TR1

S.E.E.S. #	O.E.M. #	Description
MIS-TR1	3-368-024	Transformer, 400VA, three phase, primary voltages 440/480/550, secondary voltage 214
MIS-TR2	3-368-021	Transformer, 75VA, single phase, primary voltages 208/220/240/260, secondary voltage 120
MIS-TR3	3-368-028	Transformer, 600VA, three phase, primary voltages 440/480/550, secondary voltage 214
MIS-TR4	3-368-020	Transformer, 50-60VA, single phase, primary voltage 115, secondary voltage 10
MIS-TR5	3-368-023	Transformer, 75VA, three phase, primary voltages 440/480/550, secondary voltage 120
MIS-TR6	3-368-002	Transformer, ESCO Pri 440, 480, 550, 1 PH, 120V Sec 250VA
MIS-TR7		Transformer, 18 VCT 3.0A
MIS-TR8		Transformer, Open, Single Primary 115V 18CT 2A 36VA



MIS-TR2



MIS-TR4



MIS-TR5



MIS-TR3



MIS-TR6



MIS-TR7



MIS-TR8

Rollers

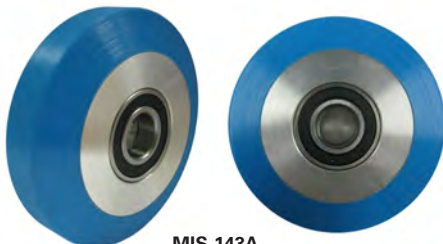

MIS-143A

S.E.E.S. #	O.E.M. #	Description
MIS-143A		Roller Guide Wheel, 3-1/4" O.D. x .5906" bearing I.D., .935" wide polyurethane tire, double bearing
MIS-143B	3-018-037	Hanger Roller, ESCO 3-11/16" 3-1/4" Run O.D. with Bushing
MIS-143C	03-018-08	Hanger Roller, ESCO 3-11/16" 3-1/4" Run O.D. without Bushing

** for more replacement rollers see pg 499.*

FUJITEC

QUICK LOCATOR GUIDE

Door Parts	608
Contacts	608
Door Gib	608
Door Lock Assemblies	608
Guide Shoe Insert	608
Door Motor	608
Escalator Parts	608
Handrail Chain	608
Reversing Chain	608
Keys	609
Push Button	608
Wheels / Rollers	609
Contacts	609
Door Gib	609
Door Lock Assemblies	609

Door Parts



FJDS-1



FJGS-4



FJLO-2D



FJLO-2

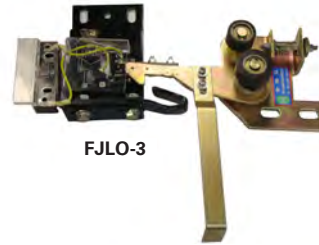

FJLO-3



FUJ-067



FUJ-074

S.E.E.S. #	O.E.M. #	Description
FJDS-1		Door Gib, Plastic Slider
FJGS-4		Guide Shoe Insert, Set of three, (1) 120mm x 28mm x 6mm, (2) 120mm x 24mm x 9mm
FJLO-2	5245AN2	Door Lock Assembly
FJLO-2C	D35092001	Contact, for FJLO-2
FJLO-2D	FJLO-2D	Fujitec Interlock, Contact Blade Assembly
FJLO-3	5245AD3	Door Lock Assembly
FUJ-067	D46149004	Door key (D46149004)
FUJ-074		Contact, Upper Interlock Bridge used on 5245AH box only

Door Motor



FUJ-077

S.E.E.S. #	O.E.M. #	Description
FJDM-001		Door Motor, MS7126/B0.25kw

Escalator

S.E.E.S. #	O.E.M. #	Description
FUJ-077	D62451001	Escalator Handrail Chain, #60, 178 Pitch
FJCH-1		Reversing Chain Pitch Line, 60 Width: 34 Length

Push Button

S.E.E.S. #	Description
FJBT-PCB-001	Hall Push Button PCB
FJBT-2-BLANK	Ultra Thin Button, Blank, HSA6000A
FPB-PCB-001	PCB, Pushbutton Board



FPB-PCB-001

Keys

S.E.E.S. #	Description
FUJK-001	Key, #80 Tubular
FUJK-002	Key, #81 Tubular
FUJK-003	Key, KA Tubular
FUJK-004	Key, KB Tubular
FUJK-005	Key, KC Tubular



FUJK-001



FUJK-002



FUJK-003



FUJK-005

Wheels/Rollers

S.E.E.S. #	O.E.M. #	Description
FJFP-1		Handrail Drive Wheel, Dim O.D. 440 mm x 35 mm
FJHR-1		Roller, Hanger, 68mm O.D. x 14mm W, bearing 6202
FJLO-5		Wheel, for Door Lock, 38mm O.D. x 16mm W, ID:14mm
FJLO-6		Wheel, for Door Lock, 30mm O.D. x 16mm W, ID:14mm
FJWH-5		Handrail Roller, Nylon with Aluminum, Black, 70 mm x 50mm, 620
FUJ-072	D00403001	Door Hanger Roller, 78mm x 17mm
FUJ-078		Door Hanger Roller, 75mm x 70mm x 20mm I.D. (6004 Brg)
FJGS-4		Guide Shoe Insert 3pcs One 120*28*6, 78mm x 17mm Two 120*24*9
FJGS-4		Guide Shoe Insert 3pcs One 120*28*6, 78mm x 17mm Two 120*24*9



FJFP-1



FJHR-1



FJLO-5



FJLO-6

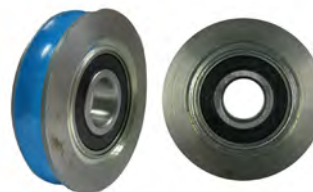

FUJ-072

The ENFORCER

SAFETY FIRST... BUILT TO LAST

PATENT PENDING

Door Gibs. Redefined.

CAN HANDLE OVER 18,000 lb OF FORCE!



SEES-ENFORCER-001

7/16"



SEES-ENFORCER-002

15/32"



SEES-ENFORCER-003

1/2"

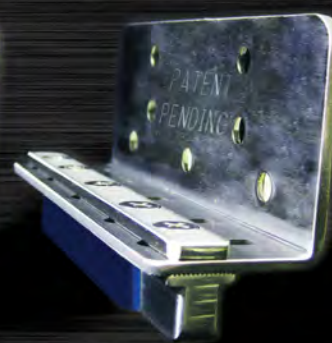

SEES-ENFORCER-004

17/32"

SAFETY: Limits liability due to door failure | **DURABILITY:** Less call backs, reduce door damage | **SAVINGS:** Reduce service calls with fewer gib replacement/door alignment.



@SEESinc



SEESinc.com/blogs

Always Smooth Sailing



SOUTHERN ELEVATOR
& ELECTRIC SUPPLY

2781 West McNab Rd., Pompano Beach, FL 33069 • 800-526-0026 • www.SEESinc.com

Car Signal Components	638-641
Battery	641
Emergency Lights	641
Emergency Stop Switch Assemblies	640-641
Fire Service Key Switches	638
Key Switches, Keys	638-639
Limit Switches	641
Position Indicators	640
Pushbutton Caps	640
Pushbutton Modules	640
Coils	644
Contacts	644-645
Door Operators	612-613
MOVFR	612
MOD, MODL Operators	613
Door Parts And Equipment	614-636
Arm & Roller	623-624
Bridging Cam	625, 627
Car Door Clutch, Clutch Kits, Links, Locking Assemblies	629-634
Clutch and Restrictor Parts, Cam, Links	633-636
Door Keys	619
Door Hanger Rollers, Wiper, Roller Kit	615-617
Door Contacts	623
Electric Eye Assembly Type T	615
Gate Switch, Contacts, Interlock Switch, Door Lock	621-624
Hanger and Track Assemblies	616-617
MO Jumper, Drive Pulleys, Cams, Bearing Block Assembly	625, 628
MOH/MOM Interlock	621-622
MOM Drive & Bearing Block, Limit Control, Clutch	628
Pick-Up Roller Assembly MOM & MOH Release	620-621
Reel Closer, Spirators and Mounting Bracket	619
Safety Edge Equipment, Type RA	614
Tension Pulley Assembly	620
Motors	637
Printed Circuit Boards	642-643
Relay Parts	646-647
Selector Contact	648
Timers	644
Wheels And Rollers	615, 648

Door Operators

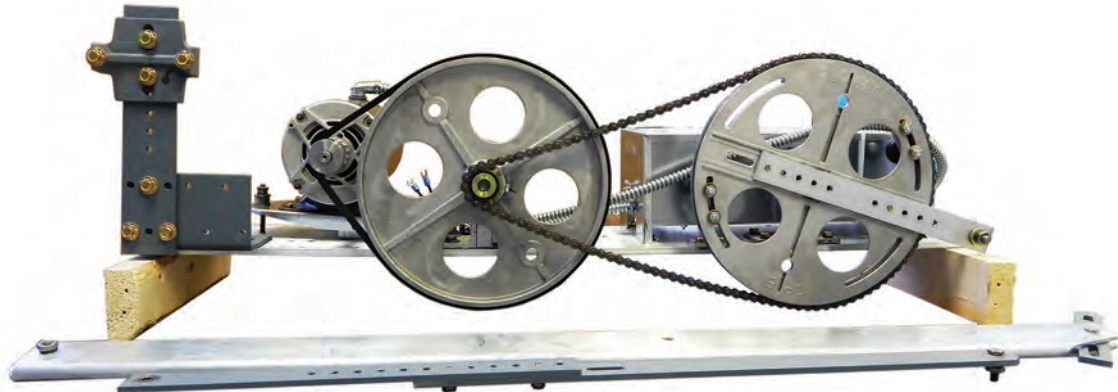

GDO-MOVFR-002R

S.E.E.S. #	O.E.M. #	Description
GDO-MOVFR-002L	OP99-0002L	Door Operator, L.H., MOVFR, Single Speed-2 Speed 25"-29", 208 VAC, 13" Hdr
GDO-MOVFR-002R	OP99-0002R	Door Operator, R.H., MOVFR, Single Speed-2 Speed 25"-29", 208 VAC, 13" Hdr
GDO-MOVFR-003L	OP99-0003L	Door Operator, L.H., MOVFR, Single Speed-2 Speed 30"-34", 208 VAC, 13" Hdr
GDO-MOVFR-003R	OP99-0003R	Door Operator, R.H., MOVFR, Single Speed-2 Speed 30"-34", 208 VAC, 13" Hdr
GDO-MOVFR-004L	OP99-0004L	Door Operator, L.H., MOVFR, Single Speed-2 Speed 35"-39", 208 VAC, 13" Hdr
GDO-MOVFR-004R	OP99-0004R	Door Operator, R.H., MOVFR, Single Speed-2 Speed 35"-39", 208 VAC, 13" Hdr
GDO-MOVFR-005L	OP99-0005L	Door Operator, L.H., MOVFR, Single Speed-2 Speed 40"-44", 208 VAC, 13" Hdr
GDO-MOVFR-005R	OP99-0005R	Door Operator, R.H., MOVFR, Single Speed-2 Speed 40"-44", 208 VAC, 13" Hdr
GDO-MOVFR-006L	OP99-0006L	Door Operator, L.H., MOVFR, Single Speed-2 Speed 45"-48", 208 VAC, 13" Hdr
GDO-MOVFR-006R	OP99-0006R	Door Operator, R.H., MOVFR, Single Speed-2 Speed 45"-48", 208 VAC, 13" Hdr
GDO-MOVFR-006L-A	OP99-0006L	Door Operator, LH, MOVFR, SS-2Spd 45-48", 115 VAC, Drive V

S.E.E.S. #	O.E.M. #	Description
GDO-MOVFR-200	OP101-0028N	Door Operator, MOVFR II 2SCP Special, with Door Drive Arm
GPC-201	MOVFR-0072N	Drive, 115 VAC for MOVFR II Oper Includes Drive Ribbon Cable

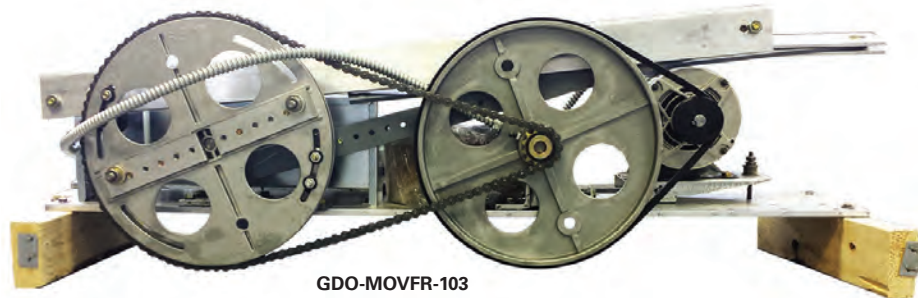

GDO-MOVFR-103

S.E.E.S. #	O.E.M. #	Description
GDO-MOVFR-101	OP100-0003N	Door Operator, CP, MOVFR, Single Speed-2 Speed, 30"-33" D.O., 208 VAC, 15" Hdr
GDO-MOVFR-102	OP100-0003N	Door Operator, CP, MOVFR, Single Speed-2 Speed, 34"-39" D.O., 208 VAC, 15" Hdr
GDO-MOVFR-103	OP100-0003N	Door Operator, CP, MOVFR, Single Speed-2 Speed, 40"-49" D.O., 208 VAC, 15" Hdr
GDO-MOVFR-104	OP100-0003N	Door Operator, CP, MOVFR, Single Speed-2 Speed, 50"-54" D.O., 208 VAC, 15" Hdr
GDO-MOVFR-105	OP100-0003N	Door Operator, CP, MOVFR, Single Speed-2 Speed, 55"-59" D.O., 208 VAC, 15" Hdr

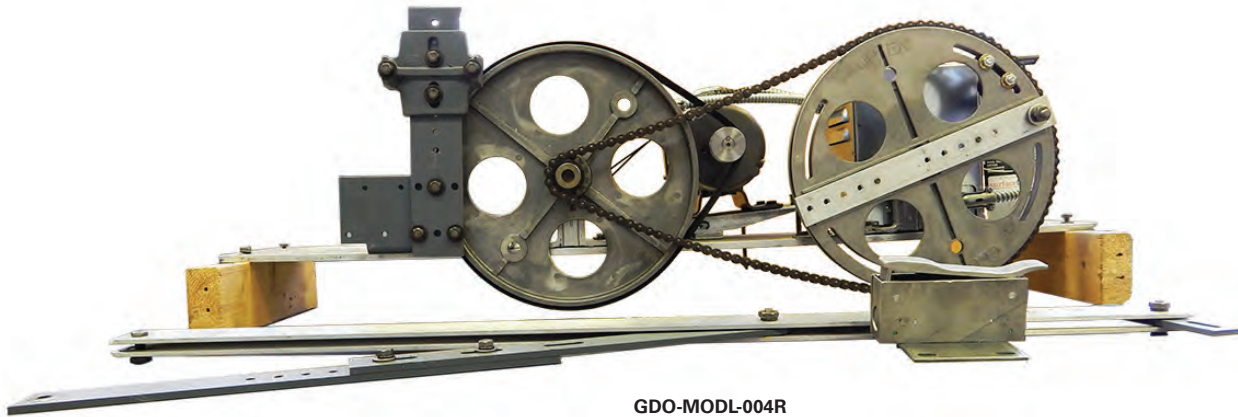

S.E.E.S. #	O.E.M. #	Description
GDO-MODL-001L	OP1-0001L	Door Operator, L.H., MODL Single Speed 22-24" D.O. 220 VDC Motor, 13" Hdr
GDO-MODL-001R	OP1-0001R	Door Operator, R.H., MODL Single Speed 22-24" D.O. 220 VDC Motor, 13" Hdr
GDO-MODL-002L	OP1-0002L	Door Operator, L.H., MODL Single Speed 25-29" D.O. 220 VDC Motor, 13" Hdr
GDO-MODL-002R	OP1-0002R	Door Operator, R.H., MODL Single Spd 25-29" D.O. 220 VDC Motor, 13" Hdr
GDO-MODL-003L	OP1-0003L	Door Operator, L.H., MODL 2 Speed 24-29" D.O. 220 VDC Motor, 13" Header
GDO-MODL-003R	OP1-0003R	Door Operator, R.H., MODL 2 Speed 24-29" D.O. 220 VDC Motor, 13" Header
GDO-MODL-004L	OP1-0004L	Door Operator, L.H., MODL Single Speed-2 Speed 30-34" D.O. 220 VDC Motor, 13" Header
GDO-MODL-004R	OP1-0004R	Door Operator, R.H., MODL Single Speed-2 Speed 30-34" D.O. 220 VDC Motor, 13" Header
GDO-MODL-005L	OPI-0005L	Door Operator, L.H. MODL Single Speed-2 Speed 35-39" D.O. 220 VDC Motor, 13" Header
GDO-MODL-005R	OPI-0005R	Door Operator, R.H. MODL Single Speed-2 Speed 35-39" D.O. 220 VDC Motor, 13" Header
GDO-MOD-001L	OP1-0006L	Door Operator, L.H., MODL, Single Speed-2 Speed 40-44" D.O., 220 VDC, 13" Hdr
GDO-MOD-001R	OP1-0006R	Door Operator, R.H., MODL, Single Speed-2 Speed 40-44" D.O., 220 VDC, 13" Hdr
GDO-MODL-KIT	OP1-0089L	MODL Door Operator Kit, ss-2s, with 220 VDC Motor
GDO-VFE2500-001L		Door Operator, L.H., VFE2500-HL, Closed Loop, 42x84, Single Speed
GDO-VFE2500-001R		Door Operator, R.H., VFE2500-HL, Closed Loop, 42x84, Single Speed

Door Parts and Equipment



GDO-10



GDO-22



GDO-22A



GDO-10B



GDO-22C



GDO-22D

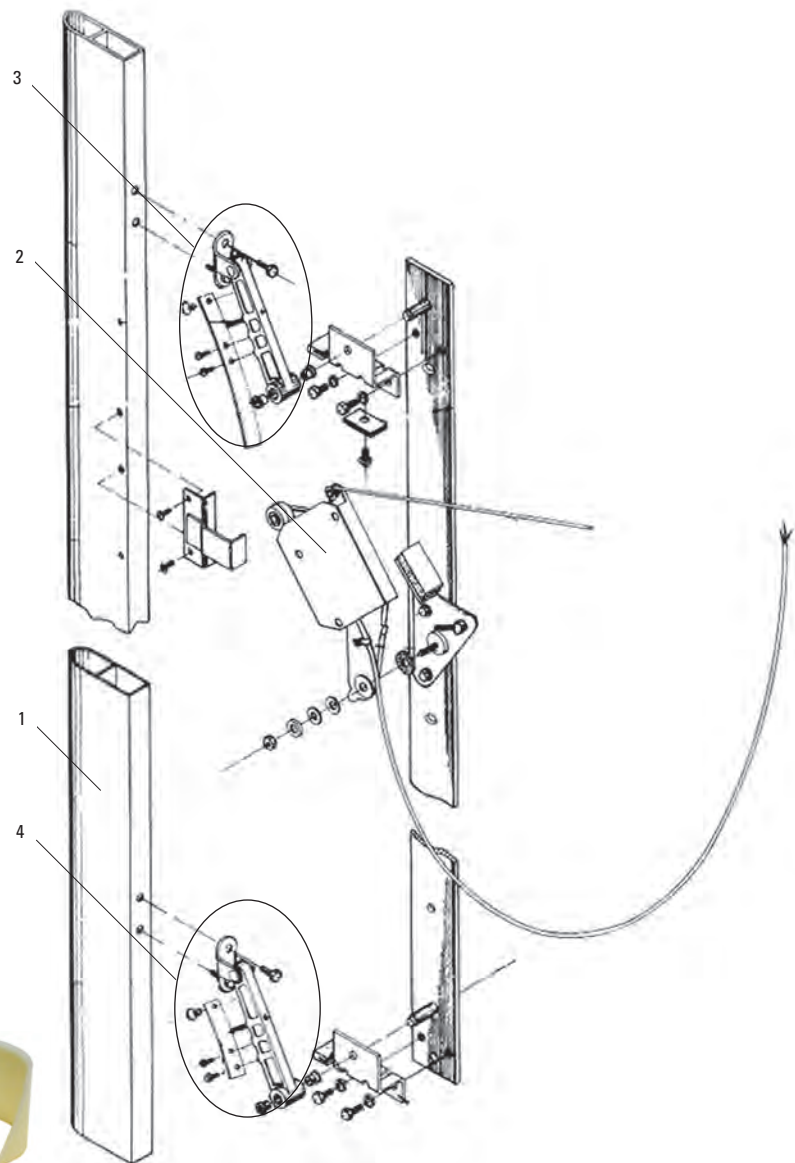

Type RA Safety Edge Equipment

Item #	S.E.E.S. #	O.E.M. #	Description
1	GSE-1B	SE5-0015N	Nosing , replacement for Safety Edge, Type RA
	GDO-10	SE2-0001R	Switch Assembly, R.H.
2	GDO-10A	SE2-0001L	Switch Assembly, L.H.
	GDO-10B	SE2-0006N, SE-2-9	Micro Switch , sold separately, also included in GDO-10 and GDO-10A
3	GDO-22	SE-5-5, SE5-0018N	Pivot Arm and Leaf Spring , assembly, Upper
4	GDO-22A	SE5-0020N, SE-5-5	Pivot Arm and Leaf Spring , assembly, Lower
	GDO-22C	SE-5-12, HWBS-0003N	Bushing , plastic for pivot arm, 7/16"
	GDO-22D	HWBS-0002N	Bushing , Nyliner 5/8 I.D. TYPE 4 Sleeve Type 4

Door Parts and Equipment

Belts

S.E.E.S. #	O.E.M. #	Description
GBLT-1	2440, 4L40, 4L440	Door Operator Belt , 1/2" x 40" V Belt HWBL-0001N



GBLT-1

Electric Eye Assembly Type "T"

S.E.E.S. #	O.E.M. #	Description
GDO-27B	EE-1-1	Power Pack
GT-4	EE-1-6	Lamp Assembly , 253X lamp, lamp socket with leads
ML-111	SE-7	Lamp , 253X, replacement lamp



GDO-27B



Hanger Rollers

S.E.E.S. #	O.E.M. #	Description
GDO-2	456DH4, HH1-0025N	Door Hanger Roller Kit , 3-1/4" diameter roller with bushing and hardware kit, aluminum hub with polyurethane tire
GDO-2W-30PK		Wiper , only for GDO-2, Pack of 30 (Oiled)
GDO-2A	HH10-0041N	Door Hanger Roller Assembly , assembly includes; nylon wheel 2-1/4" O.D. x 9/16" shown above, mounting bracket and hardware required to replace "old style" steel roller.
GDO-2AW	DRP9999N	Wiper , replacement wiper for GDO-2A door roller
GDO-2AP		Hanger Roller , 2-1/4" O.D. aluminum hub with polyurethane tire
GDO-2AP-S		Stud , Hex Bolt for GDO-2AP 3/4" Hex, 1/2-20 thread, with Grease Hole
GDO-2B		Door Hanger Roller , 3-1/4" diameter roller, aluminum hub with polyurethane tire. Used in GDO-2
GDO-2C	G401AM	Hanger Roller , 3-1/4" O.D. X .6693" I.D. with axle stud, 7/16-20 thread
GDO-2D		Hanger Roller , 3-1/4" O.D. with 7/16-20 Stud & Hardware
GDO-2N	HH1-0025N	Door Hanger Roller Kit , 3-1/4" Dia. roller with wiper, steel hub with nylon tire
GDO-2N-KIT		Door Hanger Roller Kit , 3-1/4" diameter roller with wiper and hardware kit, steel hub with nylon tire
GDO-2N-SET		Door Hanger Roller Set , 3-1/4" O.D. Nylon with Wiper, Hdw, Bushing
GDO-2S	456DH4	Door Hanger Roller , 3-1/4" diameter roller, steel hub with polyurethane tire
GDO-2SKW-B	HH5-0028N	Roller Kit , 3-1/4" steel roller with Type "C" wiper & hardware
GDO-2SK		Door Roller , 3-1/4" O.D. with hardware, steel version, made of GDO-2S and GDO-2-XHDW-KIT
GDO-2W	HH1-0026N	Wiper , replacement wiper for GDO-2N door roller
GDO-2W-B	HH5-0029N	Wiper , Oiler for Type "C" 3-1/4" hanger roller
GDO-2-INSERT		Reducer Bushing , insert for GDO-2, GDO-2N and GDO-2S
GDO-2-XHDW-KIT		Hardware Kit for hanger roller used in GDO-2 & GDO-2SK



GAL

Hanger & Track Assemblies

S.E.E.S. #	O.E.M. #	Description
GDO-CDT-001	CDH1-0104N	Hi Cab Kit, 4" Channel - 44-1/2" Long
GDO-CDH-001	CDH4-0110N	Car Hanger Assembly, A-2SCP 32-49 D.O., Ungearred Car, For Hi-Cab
GDO-CDH-001A		Car Hanger Assembly, A-2SCP 32-35 D.O. = 61" Track and Header, Ungearred Car, For Hi-Cab
GDO-CDH-001B		Car Hanger Assembly, A-2SCP 36-38 D.O. = 64" Track and Header, Ungearred Car, For Hi-Cab
GDO-CDH-001C		Car Hanger Assembly, A-2SCP 39-41 D.O. = 67" Track and Header, Ungearred Car, For Hi-Cab
GDO-CDH-001D		Car Hanger Assembly, A-2SCP 42-44 D.O. = 70" Track and Header, Ungearred Car, For Hi-Cab
GDO-CDH-001E		Car Hanger Assembly, A-2SCP 45-47 D.O. = 73" Track and Header, Ungearred Car, For Hi-Cab
GDO-CDH-001F		Car Hanger Assembly, A-2SCP 48-49 D.O. = 76" Track and Header, Ungearred Car, For Hi-Cab
GDO-CDH-001R		Car Hanger Assembly, A-2SCP 48-49 D.O. = 76" Track and Header, Ungearred Car, For Hi-Cab
GDO-CDH-002	CDH29-0010R	Car Hanger Assembly, A-2S 47-48 For CWZ-2 Car Geared
GDO-HDT-001	HH1-0017N	Hanger Track, Hatch Door 40-42 Single Speed 82" Lg with hardware
GDO-HDT-001A	HH19-0026N	Hanger Track, Hatch Door 40-42 Single Speed 82" Lg Zinc Plate
GDO-HDT-002	HH1-0016N	Hanger Track, Hatch Door 37-39 Single Speed 76" Lg with hardware
GDO-HDT-003	HHN-0018N	Hanger Track, Hatch Door 43-45 Single Speed 88" Lg with hardware
GDO-HDT-004	HH1-0015N	Hanger Track, Hatch Door 34-36 Single Speed 70" Lg with hardware
GDO-4	HH19-0007N	Hanger Assembly, Hatch door AW-SS 40"- 42" with top safety retainer
GDO-4A	HH19-0005N	Hanger Assembly with Track, AW-SS 34" D.O. with top safety retainers Yellow Zinc
GDO-4B	HH1-0100N	Hanger Assembly, Hatch Single Speed Type A 34"-36" with Top Ret
GDO-4C	HH1-0101N	Hanger Assembly, Hatch Single Speed Type A 37"-39" with Top Ret
GDO-4D	HH1-0102N	Hanger Assembly, Hatch Single Speed Type A 40"-42" with Top Ret
GDO-4E	HH1-0103N	Hanger Assembly, Hatch Single Speed Type A 43"-45" with Top Ret
GDO-4F	CDH2-0010L	Hanger, A-2SP 47"-48" D.O. Car Geared
GDO-4H	HH2-0165L	Hanger, A-2SP 47"-48" D.O. Ungearred Hatch

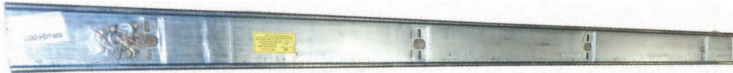

GDO-HDT-003



GDO-4



GDO-4D



GDO-4H



GDO-HDT-001

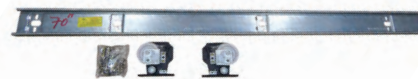

GDO-4B



GDO-4F



GDO-CDH-001R

Hanger & Track Assemblies

S.E.E.S. #	O.E.M. #	Description
GDO-4HR	HH2-0165R	Hanger, A-2SP 47"-48" D.O. Ungeared Hatch, Right Hand
GDO-11	HH1-0022R	Door Hanger Assembly, sheave assembly complete R.H. 4-1/8" CL with 3/8-16 Bolts
GDO-11-P		Door Hanger Assembly, Type A, R.H. with poly roller
GDO-11A	HH1-0022L	Door Hanger Assembly, sheave assembly complete L.H. 4-1/8" CL with 3/8-16 Bolts
GDO-11A-P		Door Hanger Assembly, Type A, L.H. with poly roller
GDO-11B	HH3-0034R	Door Hanger Assembly, Sheave assembly complete, R.H. with Top Safety Retainers
GDO-11C	HH3-0034L	Door Hanger Assembly, Sheave assembly complete, L.H. with Top Safety Retainers
GDO-11D		Shim, "C" washer 0.030" TK for door hanger (Bag of 50)
GDO-11E		Kit, Shims & Hardware for GAL door hanger assembly
GDO-11F	HH1-0027N	Shim, 1/32 "A" sheave 3/8" bolts
GDO-11G	HH1-0031N	Shim, 1/8 "A" sheave 3/8" bolts
GDO-11H	HH1-0112N	Retainer, Type "A" Top Safety with hardware
GDO-11J	HH12-0094R	Bumper, Type "OS" CP Assembly Stop, R.H.
GDO-11K	HH12-0094L	Bumper, Type "OS" CP Assembly Stop, L.H.
GDO-11L		Pendant Bolt, for GAL Hanger 3/8-16 x 6" with hardware
GDO-11M		Track Spacer, 1/8" 11 Gauge
GDO-240L	HH2-0206L	Sheave, 4.125 CL 3/8-16 2SP Fast, with Top Safety Retainers
GDO-240R	HH2-0206R	Sheave, 4.125 CL 3/8-16 2SP Fast, with Top Safety Retainers
GDO-241L	HH2-0208L	Sheave, 4.125 CL 3/8-16 2SP Slow, with Top Safety Retainers
GDO-241R	HH2-0208R	Sheave, 4.125 CL 3/8-16 2SP Slow, with Top Safety Retainers



Closers and Grasshoppers

S.E.E.S. #	O.E.M. #	Description
GDO-60	CL5-0072N	Bracket, assembly, 2/SP Slow Door Closer 3" C.L.
GDO-112L	CL5-0012L	Closer, L.H., 2S 36-40 DO & 2CP 71-82 DO Spring
GDO-113L	CL5-0013L	Closer, L.H., 2S 41-44 DO & 2CP 83-90 DO Spring
GDO-120	CL5-0020N	Closer, Arm SS-CP 36"
GDO-121	CL5-0021N	Closer, Arm SS 42"
GDO-122	CL5-0022N	Closer, Arm 2S-2SCP 42"
GDO-123	CL5-0023N	Closer, Arm SS 48"
GDO-124	CL5-0024N	Closer, Arm 2S-2SCP 48"
GDO-125	CL5-0025N	Closer, Arm SS 52"
GDO-157	CL5-0057N	Closer, Base, Double Spring
GDO-159	CL5-0059N	Closer, Guide, Double Spring
GDO-164	CL5-0064N	Closer, Link Slow door Closer (6 3/4" - 8") Combo (S + A)
GDO-168	CL5-0068N	Closer, Link Slow door Closer (10 3/4"-11 3/4") Combo (S + J)
GDO-201L	CL5-0101L	Closer, LH, 3SP 43 D.O. & 3SCP 87-88 D.O. Spring
GDO-201R	CL5-0101R	Closer, RH, 3SP 45 D.O. & 3SCP 91-92 D.O. Spring
GDO-220	CL5-0259N	Plate, Closer Reinforcement with Studs, 4-20 x1"



GDO-60



GDO-157



GDO-159



GDO-168



GDO-113L

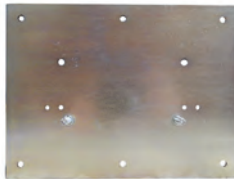

GDO-220



GDO-124

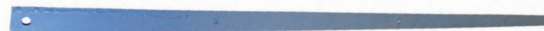

GDO-125

Door Parts

S.E.E.S. #	O.E.M. #	Description
GDO-25	HH1-0024N	Sheave Eccentric replacement roller, incl. in above assemblies
GDO-25A	HH1-0021N	Cam Kit , Hanger Track Adj Cam, 5/16"-18, lock washer and screw
GDO-86	HH2-0172L	Mechanical Interconnecting Device , set 1-1/2" CL- 3/8" MTG bolts, Left Hand, (shown)
GDO-86B	HH2-0173L	Door Part , Mechanical L.H. A set 1-1/2" CL- 3/8" MTG
GDO-86C	HH2-0177L	Door Part , Mechanical L.H. A set 1-1/2" CL- 1/2" MTG
GDO-87	HH2-0172R	Mechanical Interconnecting Device , set 1-1/2" CL- 3/8" MTG bolts, R.H.
GDO-87B	HH2-0173R	Door Part , Mechanical R.H. A set 1-1/2" CL- 3/8" MTG
GDO-87C	HH2-0177R	Door Part , Mechanical R.H. A set 1-1/2" CL- 1/2" MTG
GDO-88L	CLU16-0016R	Linkage , CWZ-2, Left
GDO-88R	CLU16-0016R	Linkage , CWZ-2, Right
GDO-89	CLU4-0024N	Cable & Cam , Type "C Low & CW Low" Clutch
GDO-89A	CLU4-0023N	Cable & Cam , Type "C & CW" Clutch
GDO-89B	CLU4-0025N	Cable & Cam , Type "C & CW" Clutch
GDO-91L	CLU16-0019L	Cam , C-2/CW-2/CWZ-2 Clutch Cable Locking, L.H.
GDO-91R	CLU16-0019R	Cam , C-2/CW-2/CWZ-2 Clutch Cable Locking, R.H.
MIS-119	INT1H-0034N	MO Key , door key with flapper and collar, slide door
MIS-119-P		Door Key , Flapper with plastic handle and flexible safety shaft
MIS-121A	INT5-0030N	M/N Key , swing door
MIS-124		Spirator , reel closer with cable, for square shaft
MIS-124-ST		Spirator , 6" SmarTork door closer, up to 20% more tension
MIS-124-ST-BK		Bracket , for Smar-Tork door closer
GDO-7	CL6-0003N	Spirator Bracket , 3-1/2" x 2-1/2"
SEES-KCDK-001		SEES Keychain Door Key , "GAL" Flapper Flexible Shaft with Key Ring



GDO-25



GDO-25A



GDO-86



GDO-88R



GDO-7



GDO-89



GDO-89A



MIS-119



MIS-119-P

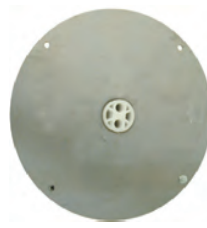

MIS-124



MIS-124-ST



SEES-KCDK-001



GDO-8A

GDO-8C

Door Parts and Equipment

Tension Pulley Assembly

S.E.E.S. #	O.E.M. #	Description
GDO-8A	HH3-0042R,	Tension Pulley Assembly , R.H., (shown)
GDO-8B	HH3-0042L	Tension Pulley Assembly , L.H.
GDO-8C	HWPL-0010N	Idler Pulley , only
GDO-8D	HH3-0032N	Relating Cable , center parting doors, 48" standard or specify required length
GDO-8D-A	CDH2-0078N	Relating cable , for side parting doors 48" L
GDO-8D-C	HH3-0028N	Relating cable assembly , 36", center opening
GDO-8D-E	HH3-0030N	Relating cable , for center parting doors 42" L
GDO-8D-SWG		Swage for Relating Cables , Pack of 5



GDO-8D

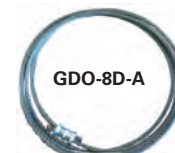

GDO-8D-A



GDO-8D-C



GDO-8D-E

Tension Pulley Assembly

S.E.E.S. #	O.E.M. #	Description
GDO-8E	HH3-0030N	Cable Kit, CYR PT 42" center relating
GDO-8E-A	HH3-0070N	Relating Cable Assy, with GDO-8A, B Pulleys
GDO-8F	CDH2-0079N	Pulley Assembly, 2SP gearing bolt, use for jobs after mid Nov. 1991, roller dia. 2-3/4"
GDO-8D-SPECIAL		Relating Cable Assembly, special size



GDO-8E



GDO-8E-A



GDO-8F

Pick-Up Assembly MOH Release

S.E.E.S. #	O.E.M. #	Description
GDO-12	INT1H-0022R	Pick-Up Roller Assembly, MOH Horizontal Release, R.H.
GDO-12-IRON-KIT		MOH Release, Cast Iron, R.H. Horizontal with Upper Link, Kit
GDO-12A	INT1H-0022L	Pick-Up Roller Assembly, MOH Horizontal INT-1-9-1 L.H. Release, L.H.
GDO-12A-IRON-KIT		MOH Release, Cast Iron, L.H. Horizontal with Upper Link, Kit
GDO-12-KIT		Pick-Up Roller Assembly Kit, MOH - Release, R.H. Horizontal with rod GDO-14
GDO-12A-KIT		Pick-Up Roller Assembly Kit, MOH Release, L.H. Horizontal with rod GDO-14
GDO-12-IRON		Pick-Up Roller Assembly, MOH Horizontal Release, R.H., Iron Base (heavy duty)
GDO-12A-IRON		Pick-Up Roller Assembly, MOH horizontal Release, L.H., Iron Base (heavy duty)
GDO-12B		Hardware Kit, snap pin with nylon bushing for GDO-12/GDO-12A

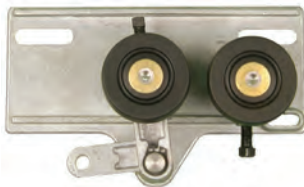

GDO-12

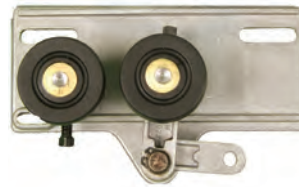

GDO-12A

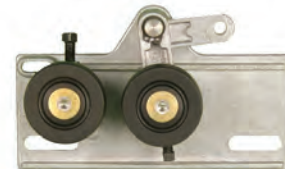

GDO-12-KIT

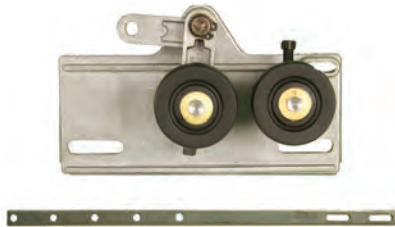

GDO-12A-KIT



GDO-12-IRON



GDO-12A-IRON



GDO-12B

Door Parts and Equipment

Pick-Up Assembly MOH & MOM Release

S.E.E.S. #	O.E.M. #	Description
GDO-6	456ES1, INT-1-10, INT1H-0023N	Pick-Up Roller , replacement for roller assemblies. Roller 1-1/2" O.D., 1-5/8" shaft
GDO-6-A	INT-1-10- SHALLOW	Door Pick-up Roller , Shallow Delrin Roller 1-1/2" O.D. x 7/16" TK, with Shaft
GDO-6-S	INT1H-0093N	Roller & Shaft , MO Cut Down 2" OAL
GDO-6-G		Pick-Up Roller , with shaft
GDO-6-P		Pick-Up Roller , 1-1/2" O.D., 1-5/8" shaft, polyurethane
GDO-13	INT1M-0033R	Pick-Up Roller Assembly , MOM Vertical Release, R.H.
GDO-13A	INT1M-0033L	Pick-Up Roller Assembly , MOM Vertical Release, L.H.
GDO-14	INT1H-0026N	Lower Link Assembly , 18-1/2" L
GDO-14A	INT1H-0018N	Upper Link Assembly , 11" L
GDO-14B	HWRV-014N	Retaining Link Pin , for Upper & Lower Interlock Kits
GDO-14C	INT1H-0028N	Lower Link "D" , MO Interlock 26-3/4" Length
GDO-14E	INT1H-0157N	Clamp Set , KMO Emergency Key Flag
GDO-15	INT1H-0016R	MO Keeper Assembly , R.H.
GDO-15A	INT1H-0016L	MO Keeper Assembly , L.H.
GDO-18	INT2H-0015N	MOCP Keeper , Fixed for center parting doors
GDO-19	INT1H-0002R	Interlock Kit , MO Assembly R.H.
GDO-19A	INT1H-0002L	Interlock Kit , MO Assembly L.H.
GDO-19B	INT1H-0031N	Mounting Plate , MO Switch, used on GDO-16
GDO-19C		Hardware kit , for MO interlock assembly
GDO-19D	INT2H-0001N	Interlock Kit , MOCPH A link, C/P 24-39" D.O., includes switch assembly, switch track, mounting plate, horizontal release upper/lower and mounting hardware
GDO-19E	INT1H-0004L	Interlock Kit , MO Assembly L.H. SS45-48 D.O., 2SP 45-52 D.O.
GDO-23		Stationary Cam , Florida flag. Release stationary cam



GDO-6



GDO-13



GDO-13A



GDO-14



GDO-19E



GDO-14B



GDO-15



GDO-18



GDO-23

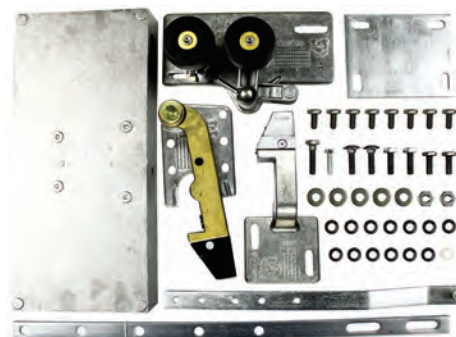

GDO-19D

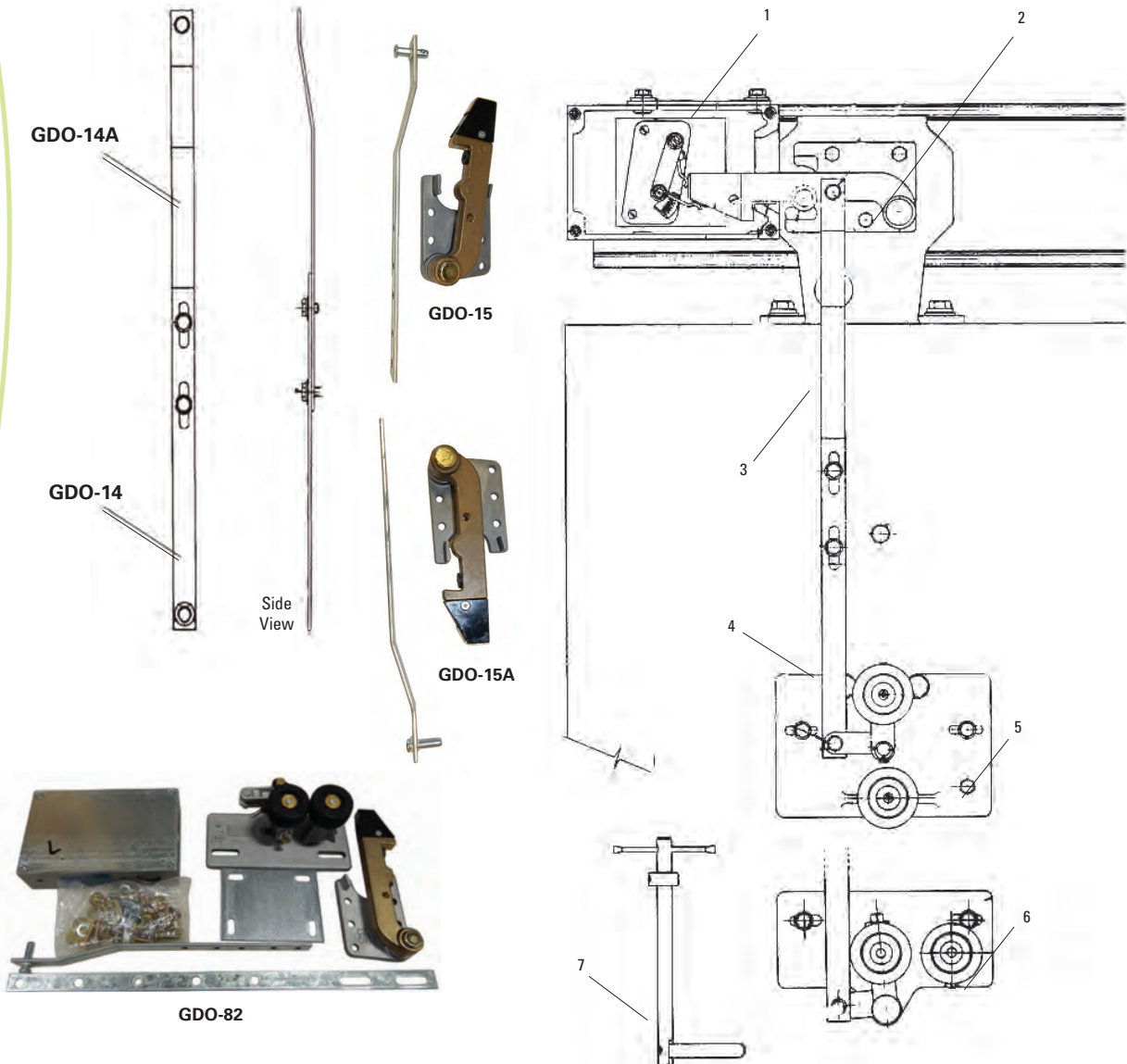

MOH/MOM Interlock

Item #	S.E.E.S. #	O.E.M. #	Description
1	GDO-17A	INT1H-0013R	MO Interlock Switch, R.H.
	GDO-17B	INT-1-1-LH, INT1H-0013L	MO Interlock Switch, L.H.
	GDO-17C	INT2H-0008N	Cover for Dual Interlock
2	GDO-15	INT1H-0016R	Keeper Assembly, R.H.
	GDO-15A	INT1H-0016L	Keeper Assembly, L.H.
3	GDO-14A	INT1H-0018N	Upper Link Assembly, 11" L
	GDO-14D	INT1H-0027N	Lower Link "C", MO Interlock 22-3/4" Length
4	GDO-14	INT1H-0026N	Lower Link Assembly, 18-1/2" L
5	GDO-13	INT1M-0033R	Vertical Release Assembly, R.H.
	GDO-13A	INT1M-0033L	Vertical Release Assembly, L.H.
6	GDO-12	VP282023, INT-1-9-1-RH	Horizontal Release Assembly, R.H.
	GDO-12A	CTIH-0022L, INT-1-9-1-LH	Horizontal Release Assembly, L.H.
7	MIS-119	INT5-0030N, INT-5-15, INT1-0034N	Flapper Key
	MIS-119-P		Door Key, Flapper with plastic handle and flexible safety shaft
	GDO-82	INT1E-0001L	Interlock Kit, MOH A link BSI-CE S/S 20"-29" 2sp/Cp & Cp 33"-39" D.O., Left Hand
	GDO-82A	INT1E-0001R	Interlock Kit, MOH A Link, R.H. SS (20-29), 2 Sp,Cp 33-39 D.O.

Door Parts and Equipment

Gate Switches

S.E.E.S. #	O.E.M. #	Description
GW-3	SW1-0007N	Roller and Bolt , Roller 1.25" O.D. x 1/2" W, Bolt 1.40" L x .43 W, for gate switch
GDO-3	INT2H-0017R, INT1H-0036R, INT-1-15RH(MOKT)	Door Contact Kit, R.H. , includes GDO-3C
GDO-3A	INT1H-0036L, INT-1-15LH, INT-1-15LH(MOKT)	Door Contact Kit, L.H. , includes GDO-3C
GDO-3C	INT2H-0015N, INT-1-5, INT1H-0017N	Contact , Bridging Block for GDO-3 & 3A
GDO-3D	INT1H-0024L	Contact Base , Left Hand interlock with insulator and hardware
GDO-3E	INT1H-0024R	Contact Base , Right Hand interlock with insulator and hardware
GDO-3E-A	INT2H-0018R	Contact Base , RH MOCP interlock with insulator and hardware
GDO-5	SW1-0003N, SW1-0012N, SWC-1-445, SW-1-15	Gate Contact Kit For GDO-16 Gate Switch
GDO-16	SW-G-1 SW1-0001N	Gate Switch complete, Type G, made of die-cast aluminum, the two studs permit left or right hand use
GDO-16-KIT	SW1-0048N	Switch Assembly , "G" Gate, MODL Kit with Gate Switch Roller
GDO-16B	SW-1-6 SW1-0005N	Arm and Roller Assembly , to make with gate switch
GDO-16G	INT5-0027N	Roller Arm Wheel , roller with bolt
GDO-16K	SW1-0044N	Switch Assembly , "G" Gate including Mounting Bracket & Hardware



GW-3

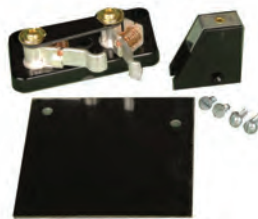

GDO-3A



GDO-3C



GDO-3D



GDO-5



GDO-16



GDO-16B



GDO-16G



GDO-16K

Door Parts and Equipment

Gate Switches

S.E.E.S. #	O.E.M. #	Description
GDO-17	INT-2-1, INT2H-0007N	Dual Interlock Switch Assembly , for center parting doors
GDO-17A	INT-1-1-RH, INT1H-0013R	MO Interlock Switch , R.H.
GDO-17B	INT-1-1-LH, INT1H-0013L	MO Interlock Switch , L.H.
GDO-17D	INT1H-0014N	Cover for Interlock MO
GDO-56	SM-INT-6-RH	Door Lock Assembly , Right Hand INT6-0001R
GDO-56A	SM-INT-6-LH	Door Lock Assembly , Left Hand
GDO-56B	INT5-0025N	Arm & Roller , for Door Lock
GDO-56C	INT5-0017N	Contact Base , Lower for M Interlock
GDO-56D	INT5-0016N	Contact Base , Upper for M Interlock
GDO-56E	INT5-0018N	Contact , M/N/NHA Cam bridging
GDO-56F	INT5-0024N	Arm & Roller , for Door Lock 3" CL
GDO-56G	INT5-0026N	Arm & Roller , for Door Lock 7-1/2" CL
GDO-56H	INT5-0014	Contact Kit , Upper for M Interlock
GRP-45	INT5-0015N	Contact Kit , M interlock lower
GDO-56J	INT18-0015N	Contact , WP/WX Interlock Bridging
GDO-56K	INT007-0020N	Interlock , "DM" with 4-1/2" CL Roller Arm
GDO-56M-R	INT22-0007R	Interlock , Kit Slide Type N, R.H.
GDO-56N-R	INT18-0001R	Interlock , Swing Manual Hatch, R.H.
GDO-56N-L	INT18-0001L	Interlock , Swing Manual Hatch, L.H.



GDO-17



GDO-17A

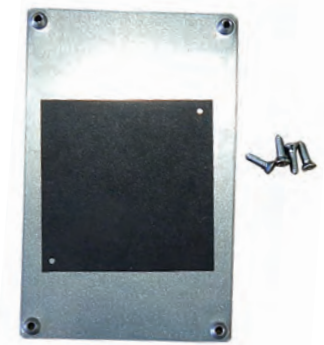

GDO-17D



GDO-56



GDO-56D



GDO-56K



GDO-56G



GDO-56J



GDO-56H



GDO-56N-L

Door Parts and Equipment

Door Operator Components

S.E.E.S. #	O.E.M. #	Description
GDO-9	INT1H-0035N, INT-2-24, INT-1-19	MO Jumper (Tomahawk)
GDO-9A	INT5-0029N	Jumper , M/N Interlock
GDO-9B	INT5-0024N	Jumper , M/N/MO Interlock
GDO-16A	OP10-0007N, OP-10-2D	Bridging Cam Assembly (4 pieces; 2 large, 2 small)
GDO-16D	OP-10-0014N, PIN-0045N	Nylon Cam Pin , 1/8" x 5/8" for GDO-16A
GDO-16E	OP-10-0013N, PIN-0044N	Nylon Cam Pin , 5/32" x 5/8" for GDO-16A
GDO-30	OP-10-5RH	Drive Pulley , "MOD", R.H., Operator Drive Pulley and bearing block assembly includes chain and U bolts, nuts and lockwashers, rubber suppressor with rivets, bearing with bearing block, stop roller and bracket, roller and bolt
GDO-30A	OP-10-5LH OP10-0029N	Drive Pulley , "MOD", L.H.
GDO-30B	OP-10-0037N	U-Bolt Kit , 3/8", MOD Drive Chain
GDO-30C	OP10-0036N	Chain Assembly , MOD drive pulley
GDO-30D	RC1-0017N	Clamp Kit , Retiring Cam Pick Up



GDO-9



GDO-9A



GDO-9B

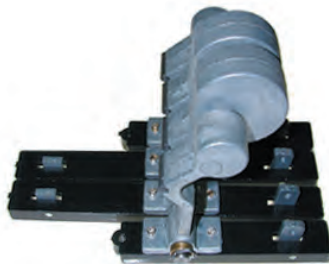

GDO-16A



GDO-30



GDO-30B

Door Operator Components

S.E.E.S. #	O.E.M. #	Description
GDO-31	OP10-0005R	Contact Base Assembly, R.H. , includes contact base and 3/8" silver contact screw 3/4" long, 12 required
GDO-31A	OP-10-2A, OP10-0005L	Contact Base Assembly, L.H. , includes contact base and 3/8" silver contact screw 3/4" long, 12 required
GDO-32	OP10-0010N, OP-10-2E	Bridging Contact, Upper, with Pin
GDO-32A	OP-100011N	Bridging Contact, Lower, with Pin
GDO-33	OP-10-5C, OP10-0034N	Bearing with Bearing Block , replacement for MOD operator drive pulley. Shaft 5/8" diameter extends 1.5" and 3.250"
GDO-83	OP10-0004R	Switch assembly, MOD limit, R.H.
GDO-90	OP10-0004L	Switch assembly, MOD limit, L.H.
GRP-3	CONT-0003N, OP10-006N	Contact , silver contact screws 3/8" diameter x 3/4" long for contact base
GDO-35	OP-10-5D1, OP10-0040N, LC-0058N	Roller and Bolt
GDO-35A	OP10-0032N, OP-10-0032N	Stop , operator pulley aluminum block
GDO-35B	OP10-0072N	Stop Assembly , for Operator Pulley Jobs after April 30, 2006
GDO-35C	OP21-0018N	Stop Assembly , for Operator Pulley MOVFR before 5-1-06
GDO-35D	OP21-0025N	Stop Assembly , for Operator Pulley Jobs After 4-30-06
GDO-35E	OP11-0015N	Roller Assembly , Oper Retiring, Cam-Pickup before 5-1-2006
GDO-35F	OP11-0031N	Roller Assembly , Oper Retiring, Cam-Pickup After 4-30-2006
GDO-35G	OP26-0003N	Stop Roller , Old Style Power Failure Emergency Unlocking Device PFU-1/2
GDO-35H	OP21-0014N	Roller Plate Assembly , Oper Retir Cam Pick Up for CT Panel Operator
GDO-35J	OP21-0015N	Roller Plate Assembly , Oper Retir Cam Pick Up for MOM/MOH Operator
GDO-35K	OP21-0016N	Roller , Bolt, Retiring Cam Pick Up Roller for All Operator



GDO-31A



GDO-32



GDO-32A



GRP-3

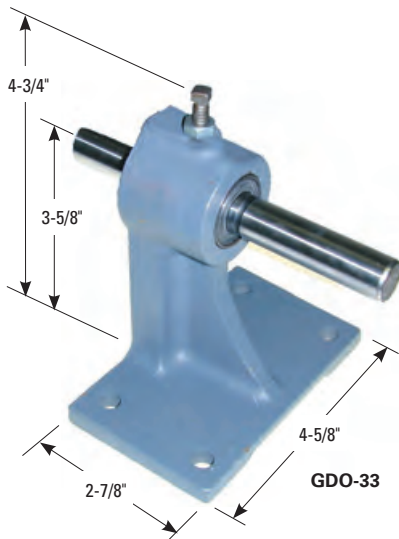

GDO-33



GDO-83



GDO-90



GDO-35

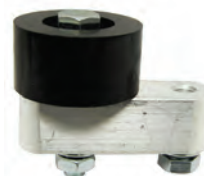

GDO-35A



GDO-35B

Door Operator Components

S.E.E.S. #	O.E.M. #	Description
GDO-34	OP-10-3, OP10-0015L, LC-0057N	Cams , set of activating cams, six pieces, MOD Limit Control
GDO-34A	OP-10-0015N	Cam , set of activating cams, R.H., set 6 pieces
GDO-36	OP10-0009N,OP-12-2D-1	Bridging Cam , Large
GDO-37	OP10-0008N,OP-12-2D-2	Bridging Cam , Small
GDO-39	OP-12-2F	Spring for Bridging Contact, positioned between cam and bridging contact
GDO-40	OP-12-3, OP-12-0006R	Activating Cam set , assembly includes eight cams for MOM and MOH Operator Limit Control to control opening and closing cycles
GDO-56F	INT5-0024N	Arm & Roller for Door Lock 3" CL
GDO-56G	INT5-0026N	Arm & Roller for Door Lock 7-1/2" CL
GDO-57	CL5-5A, CL5-0051N, SPG-0046N	Spring Closer , 18-1/2" L
GDO-57A	CL-5-5, CL5-0051N	Door Closer Assembly , spring, rod and yoke
GDO-57B		Nylon Sleeve , for GDO-57A
GDO-58	INT5-0019N	Contact Block , for GDO-51, 52, 53, 54 keeper assemblies
GDO-16A	OP10-0007N, OP-10-2D	Bridging Cam Assembly (4 pieces; 2 large, 2 small)



Door Parts and Equipment

Door Operator Components

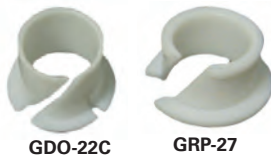

GDO-22C

GRP-27



GRP-32

GDO-41



GDO-42



GDO-43



GDO-44H



GDO-59Q



GDO-45



GDO-44B

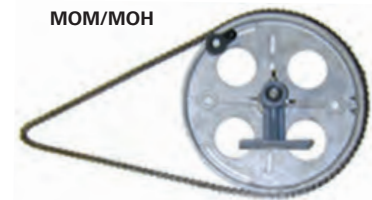

GDO-44

S.E.E.S. #	O.E.M. #	Description
GDO-22C	SE-5-12, HWBS-0003N	Bushing , plastic, for pivot arm
GRP-27	LC-8.1-70, HWBS-0001N	Nylon Bushing
GRP-32	LC-23.1-60, HWBS-0006N	Nylon Bushing
GDO-41	OP-12-4F, HWBS-0004N	Nylon Bushing, 5/8"
GDO-42	OP20-0002N, OP-20-0002N	Intermediate Pulley and bearing block assembly for 1/2" chain, MOML, 1/2" 12 tooth
GDO-42A	PL-0001N, OP20-0001N	Intermediate Pulley and bearing block assembly for 3/8" chain, MOD, 3/8" 15 tooth
GDO-43	OP-20-2, OP-20-0005N	Bearing Block , block only, replacement for above assemblies
GDO-44	OP-21-1RH, LH, OP-21-0001N	Drive Pulley and bearing block , R.H. or L.H.
GDO-44C	OP21-0005N	Chain Assembly , MOM drive pulley
GDO-44B	OP21-0006N, OP10-0037N	U-Bolt Kit , 1/2", MOM Drive Chain
GDO-44E	OP21-0017N	Pully Assembly , MOVFR/MOVR II Operator Drive, MOCT (Old)
GDO-44FL	OP21-0009L	Drive Pulley Assembly , MOML/MOHL "L" Type Panel Operator, L.H.
GDO-44FR	OP21-0009R	U-Bolt Kit , MOML/MOHL "L" Type Panel Operator, RH
GDO-44G	OP71-0022N	Pully Assembly , MOX with Sprocket Drive
GDO-44H		Chain , "MOVFRW"/"MOW", #40 Drive Pully, 60" Long with Clamps, Nickel Plated
GDO-44J	OP-21-0026N	Drive Pully , Block, Bearing
GDO-45	OP-21-1C, OP21-0003N	Bearing Block , block only, replacement
GDO-59Q	PMDG-0144N	Link , Type "LWZ-1" Retracting
GDO-59R	CLU9-0005L	Door Clutch Kit , LWZ-2 with 5-1/4" Link, L.H. with hardware
GDO-59T	CLU9-0008L	Door Clutch Kit , LWZ-2 with 16" Link, L.H. with hardware
GDO-59U	CLU9-0008R	Door Clutch Kit , LWZ-2 with 16" Link, R.H. with hardware
GDO-84	OP10-0001R	Limit control , 230V MOD with #35 chain, use for jobs before 5-1-2006
GDO-85	OP10-0001L	Limit control , 230V MOD with #35 chain, use for jobs before 5-1-2006

Door Parts and Equipment

Door Operator Components

S.E.E.S. #	O.E.M. #	Description
GDO-100	OP24-0033N	Support Arm , "HA" Drive Arm with 12" LG Plate
GDO-200	OP12-0001L	Limit Control , 230V MOM/MOH with #35 chain
GDO-202	OP22-0009N	Drive Arm Assembly , CP 40"-49" Door Opening
GDO-202A	OP22-0006L	Drive Arm Assembly , SS-2S 45" - 48" D.O.
GDO-202B	OP22-0005L	Drive Arm Assembly , SS-2S 40" - 44" D.O.
GDO-202C	OP22-0004L	Drive Arm Assembly , SS-2S 35" - 39" D.O.
GDO-204	OP34-0079N	Plate Assembly , CP-2SCP 5" CL Arm Support
GDO-204A	OP22-0178N	Link , for Operator 17-1/4" Long Connecting
GDO-205	CLU3-0335N	Locking Bar , for LWZ-1 Clutch
GDO-210	OP22-0127R	Arm Assembly , SS-2S 45"- 48" D.O.
GDO-230	OP22-0742N	Crank Arm Assembly , CP-2SCP OP Splt C/P 30" - 49" D.O. & 2S/CP 32-49 D.O.
GDO-230A	OP22-0740N	Crank Arm Assembly , S/S, 2/SP, 3SP 13-7/16" Lg
GDO-231	CHD1-0146N	Channel , Type Unistrut Adaptor with Hardware
GDO-232	INT1H-0043N	Plate , Unistrut
GDO-233	INT1H-0197N	Idler Pulley , only
GDO-234	INT1H-0042N	Relating Cable , center parting doors, 48"
GDO-235	OP22-0069N	Bracket , 14" CL Drive Arm Door Link
GDO-236	OP22-0067N	Bracket and 10" CL Drive Arm Door Link
GDO-303R	INT22-0003R	Interlock , for "N" Swing 4-1/2 Flush Mounted Lock (Kalamein Doors)
GDO-303L	INT22-0003L	Interlock , for "N" Swing 4-1/2 Flush Mounted Lock (Kalamein Doors)

*Also see page 618 for more GAL door closers.



GDO-200



GDO-202



GDO-202A



GDO-204



GDO-205



GDO-204A



GDO-303R



GDO-230



GDO-230A



GDO-235

GAL

Door Parts and Equipment

Clutch Links

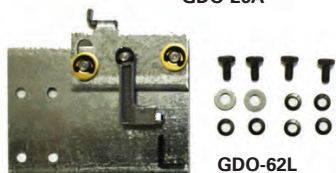
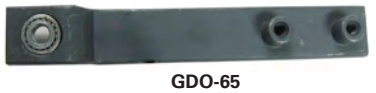
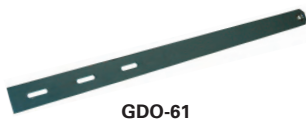

S.E.E.S. #	O.E.M. #	Description
GDO-59Q	PMDG-0144N	Link, LWZ-1 Retracting
GDO-61	OP22-0179N	Link, Type I, 16-1/2" L Slotted link with bearing
GDO-61A	OP22-0180N	Link, Type II, 24-3/4" L Slotted link with bearing
GDO-61B	OP22-0181N	Link, Type III, 31" L Slotted link with bearing
GDO-61C	CLU9-0090N	Link, Clutch, 12" L for LWZ-2 Clutch
GDO-61D	CLU9-0088N	Link, Clutch, 10" L for LWZ-2 Clutch
GDO-61E	CLU9-0086N	Link, Clutch 8" L for LWZ-2 Clutch
GDO-61F	CLU9-0084N	Link, Clutch 6" L for LWZ-2 Clutch
GDO-61G	CLU9-0085N	Link, Clutch 7" L for LWZ-2 Clutch
GDO-61H	CLU9-0087N	Link, Clutch 9" L for LWZ-2 Clutch
GDO-61J	CLU9-0089N	Link, Clutch 11" L for LWZ-2 Clutch
GDO-61K	CLU9-0091N	Link, Clutch 14" L for LWZ-2 Clutch
GDO-61L	CLU9-0092N	Link, Clutch 16" L for LWZ-2 Clutch
GDO-61M	CLU9-0064N	Link, Clutch 6" with Offset CL LWZ-2-LOW/LWZ-2-RC, LW2-LOW
GDO-61N	CLU9-0065N	Link, Clutch 7" with Offset CL LWZ-2-LOW/LWZ-2-RC, LW2-LOW
GDO-61P	CLU9-0066N	Link, Clutch 8" with Offset CL LWZ-2-LOW/LWZ-2-RC, LW2-LOW
GDO-61Q	CLU9-0067N	Link, Clutch 9" with Offset CL LWZ-2-LOW/LWZ-2-RC, LW2-LOW
GDO-61R	CLU9-0068N	Link, Clutch 10" with Offset CL LWZ-2-LOW/LWZ-2-RC, LW2-LOW
GDO-61S	CLU9-0069N	Link, Clutch 11" with Offset CL LWZ-2-LOW/LWZ-2-RC, LW2-LOW
GDO-61T	CLU9-0070N	Link, Clutch 12" with Offset CL LWZ-2-LOW/LWZ-2-RC, LW2-LOW
GDO-61U	CLU9-0071N	Link, Clutch 14" with Offset CL LWZ-2-LOW/LWZ-2-RC, LW2-LOW
GDO-61V	CLU9-0072N	Link, Clutch 16" with Offset CL LWZ-2-LOW/LWZ-2-RC, LW2-LOW
GDO-65	CLU9-0063N	Link, Clutch 5-1/4" For CL LWZ-2-LOW/LWZ-2-RC, LW2-LOW
GDO-65A	CLU9-0083N	Link, Clutch 5-1/4" L for LWZ-2 Clutch
GDO-65B	CLU9-0259N	Link, Clutch 18" CL LWZ2-LOW/LWZ-2-LRC
GDR-115	CLU3-0336N	Link, LWZ-1 3 15/16" Connecting 2 1/2" x 1/4" Rod
GDR-116	CLU3-0337N	Link, LWZ-1 7 15/16" Connecting 2 1/2" x 1/4" Rod
GDR-117	CLU3-0338N	Link, LWZ-1 11 15/16" Connecting 2 1/2" x 1/4" Rod
GDR-118	CLU3-0339N	Link, LWZ-1 15 15/16" Connecting 2 1/2" x 1/4" Rod
GDR-119	CLU3-0340N	Link, LWZ-1 19 15/16" Connecting 2 1/2" x 1/4" Rod
GDR-120	CLU3-0341N	Link, LWZ-1 23 15/16" Connecting 2 1/2" x 1/4" Rod
GDR-121	CLU3-0342N	Link, LWZ-1 27 15/16" Connecting 2 1/2" x 1/4" Rod
GDR-122	CLU3-0343N	Link, LWZ-1 7 15/16" Connecting 5 1/2" x 1/4" Rod
GDR-123	CLU3-0344N	Link, LWZ-1 15 15/16" Connecting 2 1/2" x 1/4" Rod
GDR-124	CLU3-0345N	Link, LWZ-1 19 15/16" Connecting 2 1/2" x 1/4" Rod
GDR-125	CLU3-0346N	Link, LWZ-1 23 15/16" Connecting 5 1/2" x 1/4" Rod

Locking Assemblies

S.E.E.S. #	O.E.M. #	Description
GDO-26	BR-0009N, OP-22-12, HWBR-0009N	Bearing Kit for Operator Crank Arm
GDO-26A	HWBR-0008N	Bearing Kit, 7/8" Shoulder for clutch and door links
GDO-62L	CLU9-0115L	Locking Assembly, L.H. For LWZ-2 with 36" Rod and standard cam
GDO-62R	CLU9-0115R	Locking Assembly, R.H. For LWZ-2 with 36" Rod and standard cam



Door Parts and Equipment

Locking Assemblies

S.E.E.S. #	O.E.M. #	Description
GDR-001	CLU3-0254L	Locking Assembly, LWZ-1 SS 22-29 D.O. CP 30-39 D.O.
GDR-002	CLU3-0254R	Locking Assembly, LWZ-1 SS 22-29 D.O. CP 30-39 D.O.
GDR-003	CLU3-0255L	Locking Assembly, LWZ-1 CP 24-29 D.O. & 2SCP 32-39 D.O.
GDR-004	CLU3-0255R	Locking Assembly, LWZ-1 CP 24-29 D.O. & 2SCP 32-39 D.O.
GDR-005	CLU3-0256L	Locking Assembly, LWZ-1 2SCP 40-49 D.O.
GDR-006	CLU3-0256R	Locking Assembly, LWZ-1 2SCP 40-49 D.O.
GDR-007	CLU3-0257L	Locking Assembly, LWZ-1 SS-2SP 30-3 D.O., CP 40-49 D.O., Left Hand
GDR-008	CLU3-0257R	Locking Assembly, LWZ-1 SS-2SP 30-3 D.O., CP 40-49 D.O., Right Hand
GDR-009	CLU3-0258L	Locking Assembly, LWZ-1 2SCP 50-59 D.O.
GDR-010	CLU3-0258R	Locking Assembly, LWZ-1 2SCP 50-59 D.O.
GDR-011	CLU3-0259L	Locking Assembly, LWZ-1 SS 40-44 D.O. 2SP 24-29 D.O. 40-44 D.O. CP 50-59
GDR-012	CLU3-0259R	Locking Assembly, LWZ-1 SS 40-44 D.O. 2SP 24-29 D.O. 40-44 D.O. CP 50-59
GDR-013	CLU3-0260L	Locking Assembly, LWZ-1 SS 45-48 D.O. 2SP 45-52 D.O. CP 60-83 D.O. 2SCP 60
GDR-014	CLU3-0260R	Locking Assembly, LWZ-1 SS 45-48 D.O. 2SP 45-52 D.O. CP 60-83 D.O. 2SCP 60
GDR-015	CLU3-0261L	Locking Assembly, LWZ-1 2SP 53-60 D 2SCP 80-83 D.O.
GDR-016	CLU3-0261R	Locking Assembly, LWZ-1 2SP 53-60 D 2SCP 80-83 D.O.
GDR-017	CLU3-0262L	Locking Assembly, LWZ-1 2SP 61-68 D
GDR-018	CLU3-0262R	Locking Assembly, LWZ-1 2SP 61-68 D
GDR-019	CLU3-0263L	Locking Assembly, LWZ-1 2SP 69-72 D
GDR-020	CLU3-0263R	Locking Assembly, LWZ-1 2SP 69-72 D
GDR-021	CLU3-0271L	Locking Assembly, LWZ-1 "C" Hngr SS 22-29 D.O. CP 30-39 D.O. 2SCP 32-39 D
GDR-022	CLU3-0271R	Locking Assembly, LWZ-1 "C" Hngr SS 22-29 D.O.
GDR-023	CLU3-0272L	Locking Assembly, LWZ-1 "C" Hngr SS 2SP 30-39 D.O. CP & 2SCP 40-49 D.O.
GDR-024	CLU3-0272R	Locking Assembly, LWZ-1 "C" Hngr SS 2SP 30-39 D.O.
GDR-025	CLU3-0273L	Locking Assembly, LWZ-1 "C" Hngr SS 2SP 40-44 D.O. CP & 2SCP 50-59 D.O.
GDR-026	CLU3-0273R	Locking Assembly, LWZ-1 "C" Hngr SS 2SP 40-44 D.O.
GDR-027	CLU3-0274L	Locking Assembly, LWZ-1 "C" Hngr SS 45-48 D.O. 2SP 45-52 D.O. 3SP 30-5
GDR-028	CLU3-0274R	Locking Assembly, LWZ-1 "C" Hngr SS 45-48 D.O. 2SP 45-52 D.O. 3SP 30-54 D
GDR-029	CLU3-0275L	Locking Assembly, LWZ-1 "C" Hngr 2S 53-60 D.O. 3SP 53-64 D.O.
GDR-030	CLU3-0275R	Locking Assembly, LWZ-1 "C" Hngr 2S 53-60 D.O. 3SP 53-64 D.O.
GDR-031	CLU3-0276L	Locking Assembly, LWZ-1 "C" Hngr 2S 61-68 D.O. 3SP 65-69 D.O.
GDR-032	CLU3-0276R	Locking Assembly, LWZ-1 "C" Hngr 2S 61-68 D.O. 3SP 65-69 D.O.
GDR-033	CLU3-0277L	Locking Assembly, LWZ-1 "C" Hngr 2S 69-72 D.O.
GDR-034	CLU3-0277R	Locking Assembly, LWZ-1 "C" Hngr 2S 69-72 D.O.
GDR-035	CLU3-0285L	Locking Assembly, LWZ-1 SS 22-29 D.O.
GDR-036	CLU3-0285R	Locking Assembly, LWZ-1 SS 22-29 D.O.
GDR-037	CLU3-0286L	Locking Assembly, LWZ-1 SS-2SP 30-39 D.O.
GDR-038	CLU3-0286R	Locking Assembly, LWZ-1 SS-2SP 30-39 D.O.
GDR-039	CLU3-0287L	Locking Assembly, LWZ-1 SS-2SP 40-44 D.O.
GDR-040	CLU3-0287R	Locking Assembly, LWZ-1 SS-2SP 40-44 D.O.
GDR-041	CLU3-0288L	Locking Assembly, LWZ-1 3SP 30-54 D
GDR-042	CLU3-0288R	Locking Assembly, LWZ-1 3SP 30-54 D
GDR-043	CLU3-0289L	Locking Assembly, LWZ-1 SS-2SP 45-48 D.O.
GDR-044	CLU3-0289R	Locking Assembly, LWZ-1 SS-2SP 45-48 D.O.



Door Parts and Equipment

Locking Assemblies

S.E.E.S. #	O.E.M. #	Description
GDR-045	CLU3-0290L	Locking Assembly, LWZ-1 3SP 55-64 D
GDR-046	CLU3-0290R	Locking Assembly, LWZ-1 3SP 55-64 D
GDR-047	CLU3-0291L	Locking Assembly, LWZ-1 2SP 53-60 D
GDR-048	CLU3-0291R	Locking Assembly, LWZ-1 2SP 53-60 D
GDR-049	CLU3-0292L	Locking Assembly, LWZ-1 3SP 65-69 D
GDR-050	CLU3-0292R	Locking Assembly, LWZ-1 3SP 65-69 D
GDR-051	CLU3-0293L	Locking Assembly, LWZ-1 2SP 61-68 D
GDR-052	CLU3-0293R	Locking Assembly, LWZ-1 2SP 61-68 D
GDR-053	CLU3-0294L	Locking Assembly, LWZ-1 2SP 69-72 D
GDR-054	CLU3-0294R	Locking Assembly, LWZ-1 2SP 69-72 D
GDR-055	CLU3-0295L	Locking Assembly, LWZ-1 CP 24-29 D.O. 2SCP 32-39 D.O.
GDR-056	CLU3-0296L	Locking Assembly, LWZ-1 CP 30-39 D.O.
GDR-057	CLU3-0297L	Locking Assembly, LWZ-1 CP 40-49 D.O.
GDR-058	CLU3-0298L	Locking Assembly, LWZ-1 2SCP 40-49
GDR-059	CLU3-0299L	Locking Assembly, LWZ-1 2SCP 50-59
GDR-060	CLU3-0300L	Locking Assembly, LWZ-1 CP 50-59 D.O.
GDR-061	CLU3-0301L	Locking Assembly, LWZ-1 CP 60-83 D.O. 2SCP 60-79 D.O.
GDR-062	CLU3-0302L	Locking Assembly, LWZ-1 2SCP 80-83
GDR-063	CLU3-0303L	Locking Assembly, LWZ-1 "C" Hngr SS 22-29 D.O.
GDR-064	CLU3-0303R	Locking Assembly, LWZ-1 "C" Hngr SS 22-29 D.O.
GDR-065	CLU3-0304L	Locking Assembly, LWZ-1 "C" Hngr SS 2SP 30-39 D.O.
GDR-066	CLU3-0304R	Locking Assembly, LWZ-1 "C" Hngr SS 2SP 30-39 D.O.
GDR-067	CLU3-0305L	Locking Assembly, LWZ-1 "C" Hngr SS 2SP 40-44 D.O.
GDR-068	CLU3-0305R	Locking Assembly, LWZ-1 "C" Hngr SS 2SP 40-44 D.O.
GDR-069	CLU3-0306L	Locking Assembly, LWZ-1 "C" Hngr SS 45-48 D.O. 2SP-3SP 45-52 D.O.
GDR-070	CLU3-0306R	Locking Assembly, LWZ-1 "C" Hngr SS 45-48 D.O. 2SP-3SP 45-52 D.O.
GDR-071	CLU3-0307L	Locking Assembly, LWZ-1 "C" Hngr 2S 3SP 53-60 D.O.
GDR-072	CLU3-0307R	Locking Assembly, LWZ-1 "C" Hngr 2S 3SP 53-60 D.O.
GDR-073	CLU3-0308L	Locking Assembly, LWZ-1 "C" Hngr 2S 3SP 61-68 D.O.
GDR-074	CLU3-0308R	Locking Assembly, LWZ-1 "C" Hngr 2S 3SP 61-68 D.O.
GDR-075	CLU3-0309L	Locking Assembly, LWZ-1 "C" Hngr 3S 69-72 D.O.
GDR-076	CLU3-0309R	Locking Assembly, LWZ-1 "C" Hngr 3S 69-72 D.O.
GDR-077	CLU3-0310L	Locking Assembly, LWZ-1 "C" Hngr CP 30-39 D.O. 2SCP 32-39 D.O.
GDR-078	CLU3-0311L	Locking Assembly, LWZ-1 "C" Hngr CP 2SCP 40-49 D.O.
GDR-080	CLU3-0313L	Locking Assembly, LWZ-1 "C" Hngr CP 2SCP 60-83 D.O.
GDR-081	CLU3-0314L	Locking Assembly, LWZ-1 3SP 30-54 D
GDR-082	CLU3-0314R	Locking Assembly, LWZ-1 3SP 30-54 D
GDR-083	CLU3-0315L	Locking Assembly, LWZ-1 3SP 55-64 D
GDR-084	CLU3-03153	Locking Assembly, LWZ-1 3SP 55-64 D
GDR-085	CLU3-0316L	Locking Assembly, LWZ-1 3SP 65-69 D
GDR-086	CLU3-0316R	Locking Assembly, LWZ-1 3SP 65-69 D
GDR-087	CLU3-0320L	Locking Assembly, LWZ-1 SS(HA) 24-29 D.O.
GDR-088	CLU3-0320R	Locking Assembly, LWZ-1 SS(HA) 24-29 D.O.
GDR-089	CLU3-0321L	Locking Assembly, LWZ-1 SS(HA) 30-39 D.O.
GDR-090	CLU3-0321R	Locking Assembly, LWZ-1 SS(HA) 30-39 D.O.
GDR-091	CLU3-0322L	Locking Assembly, LWZ-1 2SP(HA) 30-32 D.O.
GDR-092	CLU3-0322R	Locking Assembly, LWZ-1 2SP(HA) 30-32 D.O.
GDR-093	CLU3-0323L	Locking Assembly, LWZ-1 2SP(HA) 33-39 D.O.
GDR-094	CLU3-0323R	Locking Assembly, LWZ-1 2SP(HA) 33-39 D.O.
GDR-095	CLU3-0324L	Locking Assembly, LWZ-1 2S(HA) 40-44 D.O.
GDR-096	CLU3-0324R	Locking Assembly, LWZ-1 2S(HA) 40-44 D.O.
GDR-097	CLU3-0325L	Locking Assembly, LWZ-1 2SP(HA) 45-48 D.O.
GDR-098	CLU3-0325R	Locking Assembly, LWZ-1 2SP(HA) 45-48 D.O.

Door Parts and Equipment

Locking Bar Guides

S.E.E.S. #	O.E.M. #	Description
GDR-099	CLU3-0326L	Guide, LWZ-1 Locking Bar SS 22-48 D.O. 2SP 24-72 D.O. 3SP 30-69 D.O. C
GDR-100	CLU3-0326R	Guide, LWZ-1 Locking Bar SS 22-48 D.O. 2SP 24-72 D.O. 3SP 30-69 D.O. C
GDR-101	CLU3-0327L	Guide, LWZ-1 Locking Bar CP 24-29 D.O. 2SCP 32-59 D.O.
GDR-102	CLU3-0327R	Guide, LWZ-1 Locking Bar CP 24-29 D.O. 2SCP 32-59 D.O.
GDR-103	CLU3-0328L	Guide, LWZ-1 "C" Hngr Locking Bar 22-48 D.O. 2SP 30-72 D.O. 3SP 30-6
GDR-104	CLU3-0328R	Guide, LWZ-1 "C" Hngr Locking Bar 22-48 D.O. 2SP 30-72 D.O. 3SP 30-6
GDR-105	CLU3-0329L	Guide, LWZ-1 Locking Bar SS 24-42 D.O.
GDR-106	CLU3-0329R	Guide, LWZ-1 Locking Bar SS 24-42 D.O.
GDR-107	CLU3-0330L	Guide, LWZ-1 Locking Bar 2SP 33-4 D.O.
GDR-108	CLU3-0330R	Guide, LWZ-1 Locking Bar 2SP 33-4 D.O.



GDO-46E



GDO-46C-A

Door Clutch Kits

S.E.E.S. #	O.E.M. #	Description
GDO-46	OP-30, CLU11-0004N	Car Door Clutch, Type LWZ-2, 8" Arm
GDO-46A	OP-30, CLU11-0006N	Car Door Clutch, Type LWZ-2, 10" Arm
GDO-46B	OP-30-2, CLU1-0033N	Door Open Vane, 24-5/8" for Type L
GDO-46C-A	CLU1-0037N	Roller, 15/16" for GDO-46C
GDO-46C-B	CLU1-0036N	Roller, 13/16" for LW Clutch
GDO-46E	SPG-0019N	Spring, Clutch Vane Return LW & LWZ 4 Per Clutch Assembly
GDO-46F	CLU11-0001N	Clutch LW-2 5-1/4" Link, 2SP 24-26 D.O., 3SP 30-34 CP 23-33
GDO-51	M-14-2, INT4-0001N	Swing Door Keeper
GDO-52	M-14-20, INT4-0002N	Concealed Mounted Keeper
GDO-53	M-14-K, INT4-0003N	Kalomin Keeper
GDO-54	M-14-5, M-14-21-2, INT4-0004N	Slide Door Keeper for swing door
GDR-109	CLU3-0331L	Cam, LWZ-1 Standard Locking assembly
GDR-110	CLU3-0331R	Cam, LWZ-1 Standard Locking assembly
GDR-110A		Cam, LWZ-1 Locking assembly RH Modified
GDR-111	CLU3-0333L	Cam, LWZ-1 Replacement Locking For S/S & 2/SP Jobs Prior June 9
GDR-112	CLU3-0333R	Cam, LWZ-1 Replacement Locking For S/S & 2/SP Jobs Prior June 9
GDR-113	CLU3-0334L	Cam, LWZ-1 Replacement Locking For C/P, 2SP/CP Jobs Prior June 9

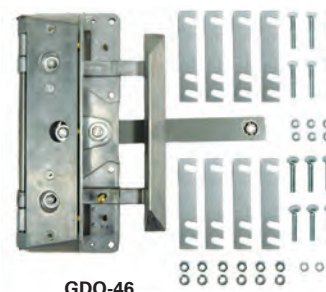

GDO-46



GDO-46A



GDO-46B

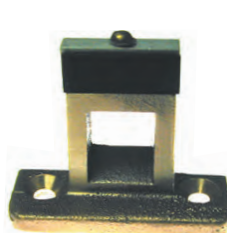

GDO-51



GDO-52



GDO-53



GDO-54



GDR-112

Door Clutch Kits

S.E.E.S. #	O.E.M. #	Description
GDO-59	CLU3-0006L, CLU9-000L	Door Clutch Kit , LWZ-2 with 10" Link, L.H., with HW
GDO-59A	CLU3-0006R, CLU9-000R	Door Clutch Kit , LWZ-2 with 10" Link, R.H., with HW
GDO-59B	CLU9-0002L	Door Clutch Kit , LWZ-2 with 6" Link, L.H., with HW
GDO-59C	CLU9-0004L	Door Clutch Kit , LWZ-2 with 12" Link, L.H., with HW
GDO-59D	CLU9-0003L	Door Clutch Kit , LWZ-2 with 8" Link, L.H., with HW
GDO-59E	CLU9-0002R	Door Clutch Kit , LWZ-2 with 6" Link, R.H., with HW
GDO-59F	CLU9-0003R	Door Clutch Kit , LWZ-2 with 8" Link, R.H., with HW
GDO-59G	CLU9-0004R	Door Clutch Kit , LWZ-2 with 12" Link, R.H. with HW
GDO-59H	CLU9-0013L	Door Clutch Kit , LWZ-2-LOW w/ 10" Link, with HW
GDO-59I	CLU9-0013R	Door Clutch Kit , LWZ-2-LOW w/ 10" Link, R.H., w/ HW
GDO-59J	CLU9-0014L	Door Clutch Kit , LWZ-2-LOW w/ 6" Link, L.H., w/ HW
GDO-59K	CLU9-0014R	Door Clutch Kit , LWZ-2-LOW w/ 6" Link, R.H., w/ HW
GDO-59L	CLU9-0015L	Door Clutch Kit , LWZ-2-LOW w/ 8" Link, L.H., w/ HW
GDO-59M	CLU9-0015R	Door Clutch Kit , LWZ-2-LOW w/ 8" Link, R.H., w/ HW
GDO-59N	CLU9-0016L	Door Clutch Kit , LWZ-2-LOW w/ 12" Link, L.H., w/ HW
GDO-59P	CLU9-0016R	Door Clutch Kit , LWZ-2-LOW w/ 12" Link, R.H., w/ HW
GDO-80	CLU16-0003L	Clutch , CWZ-2 with roller & lock cable with door mounting plate, left
GDO-80A	CLU17-0005R	Clutch , C-2 with Sheave Mntg Plate Cable R.H.
GDO-80B	CLU17-0005L	Clutch , C-2 with Sheave Mntg Plate Cable L.H.
GDO-80R	CLU16-0001R	Clutch , CWZ-2 with Roller & Lock Cable Right
GDO-80L	CLU16-0001L	Clutch , CWZ-2 with Roller & Lock Cable Left
GDO-81	CLU15-0008N	Clutch , L-2 12" Link, SS 45-48 D.O. 2SP 45-56 D.O. 3SP 55-59 D.O.
GDO-81R	CLU16-0003R	Clutch , CWZ-2 with roller and lock cable, with door mounting plate, right
GDO-86A	HH2-0176L	Mechanical Interconnecting Dev Set A2 , with 1/2" Mounting Bolts, Left
GDO-87A	HH2-0176R	Mechanical Interconnecting Dev Set A2 , with 1/2" Mounting Bolts, Right

GDO-59 - GDO-59G

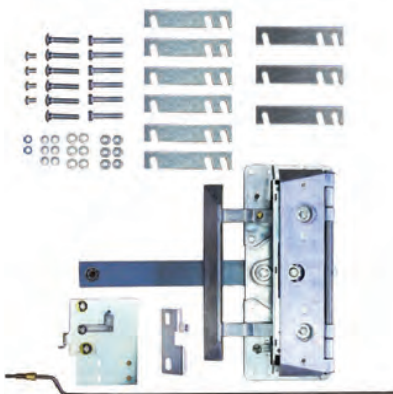

* LWZ-2 Clutches come with hardware and restrictor parts.

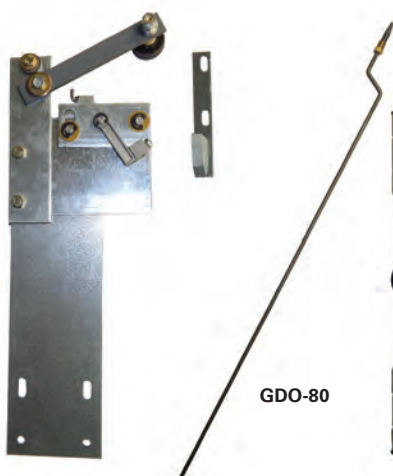

GDO-80



GDO-86A

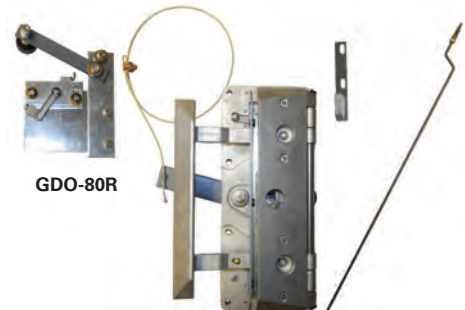

GDO-80R

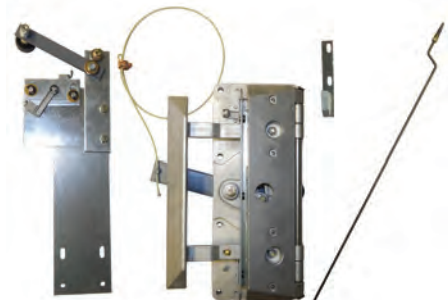

GDO-81R

Door Parts and Equipment

Clutch and Restrictor Parts

S.E.E.S. #	O.E.M. #	Description
GDO-63	CLU9-0045N	Hardware, Clutch Mounting LW2/LW2-LRC STD/LWZ-2/LWZ-2-LRC
GDO-63A	CLU9-0046N	Hardware, Clutch Mounting, LW2-LOW/LW2-LRC LOW/LWZ-2-LOW/LWZ-2-LRC
GDO-64L	CLU9-0049L	Cam, LWZ-2 Standard Locking L.H., includes Hardware
GDO-64R	CLU9-0049R	Cam, LWZ-2 Standard Locking R.H., includes Hardware
GDO-69	CLU9-0111N	Cam, Clutch Actuating LW2/LWZ2 LW2-LOW & LWZ-2-LOW
GDO-69L	CLU9-0238L	Cam, L.H. Clutch Actuating For LW-2-LRC/LWZ-2-LRC
GDO-69R	CLU9-0238R	Cam, R.H. Clutch Actuating For LW-2-LRC/LWZ-2-LRC
GDO-66L	CLU9-0101L	Guide, Clutch Locking L.H. LWZ-2
GDO-66R	CLU9-0101R	Guide, Clutch Locking R.H. LWZ-2
GDO-67	CLU9-0103N	Vane, Clutch Rear Assembly LWZ-2-HA
GDO-68	CLU9-0108N	Rod, 36" Clutch Zone Locking LWZ-2
GDO-68A	CLU9-0094N	Rod, 24" Clutch Zone Locking LWZ-2

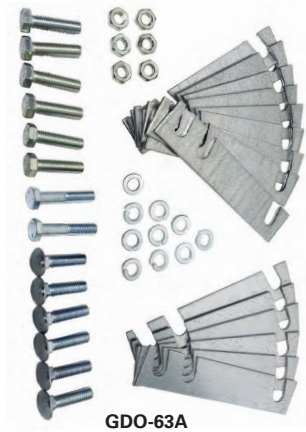

Door Parts and Equipment

Clutch and Restrictor Parts

S.E.E.S. #	O.E.M. #	Description
GDO-70	CLU9-0113N	Roller , 1-1/4" Dia. Used On LWZ-2/LZ-2 Clutch
GDO-70A	SPG-0019N	Spring , 7/8" LG x .250" O.D. for LW2-LWZ-2 Clutches
GDO-70B	SPG-0036N	Spring , Conical 1-1/4" x 3/4" O.D. for LW2-LWZ-2 Clutches
GDO-71L	CLU9-0114L	Locking Assy , LWZ-2 Clutch L.H. 36" Rod with California Cam
GDO-71R	CLU9-0114R	Locking Assy , LWZ-2 Clutch R.H. 36" Rod with California Cam
GDO-73	CLU9-0116N	Vane , Door Close for LWZ-2/LW-2 Clutch
GDO-74	CLU9-0255N	Sensing Bar & Pivot , LW-2 Zone Lock W/2, 1-9/32" L Pins
GDO-75	CLU9-0256N	Arm , LWZ-2 Retracting Assy Rep For Jobs After 07-31-2006
GDO-76L	CLU9-0257L	Vane , LWZ-2 L.H. Door Open
GDO-76R	CLU9-0257R	Vane , LWZ-2 R.H. Door Open
GDO-77	SHF-0065N	Shaft , 7/16" x 11-7/8" LG LWZ2 Open Vane 11-1/2" Headless



GDO-70



GDO-70A



GDO-70B



GDO-73



GDO-74



GDO-75



GDO-76L



GDO-76R



GDO-77

Motors

S.E.E.S. #	O.E.M. #	Description
GCB-01	MTR-00018N SET	Brush, FHP HRG.25 x .375 x 1.06 for GDO-24 Original GAL Motor
GCB-02	63913688	Brush, FHP-234 .25 x .50x 1.13 for GDO-24 SEES AOS Motor
GDO-24	MTR-0008N	Operator Motor, 1/6 HP, 230 VDC, 1140 RPM, shunt wound, does not come with pulley
GDO-24A	HWPL-00-1N	Pulley, 2" O.D. for 5/8" shaft, for motor GDO-24 and GDO-24B
GDO-24B	MTR-0009N	Operator Motor, 1/4 HP, 230 VDC, 1140 RPM, shunt wound, does not come with pulley
GDO-24D	MTR-0008N-PM	Motor, Door Operator, 1/6 HP, 1140 RPM, 230 VDC, MOD Type, permanent magnet
GDO-24DA		Shaft Pulley, 1-3/8" x 1/2"
GDO-24E	MTR-0011N	Door Motor, PM, 115 VDC, 1/6 HP, 1140 RPM MOD
GDO-24F	MTR-0010N	Door Motor, 1/2 HP 230 VDC PM (MOH OPP), 1140 RPM
GDO-24H	MTR-0021N	Door Motor, 1/2 HP 230 VAC 3Ph, 60 Hz, 1140 RPM (MOVFR operator)
GDO-24J	MTR-0023N	Door Motor, 1/2 HP 208-230/460V, 3Ph, 1724/1425 RPM Water Resistant



GDO-24



GDO-24A



GDO-24B



GCB-01



GCB-02

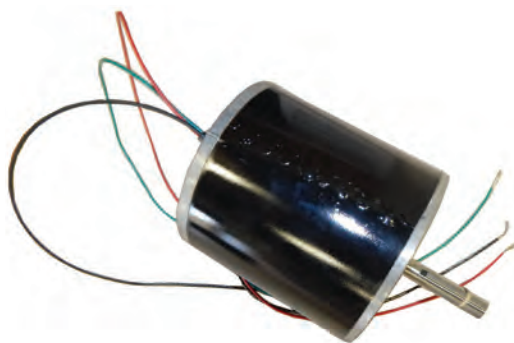

GDO-24D



GDO-24E



GDO-24F



GDO-24H



GDO-24DA



GDO-24J

Car Signal Components

Key Switches

S.E.E.S. #	O.E.M. #	Marking/Description
GKS-2	KS3-0059H	Fire Service Key Switch, PH II, Horizontal, car (1617 key)
GKS-2V	KS3-0059V	Fire Service Key Switch, PH II, Vertical, Remove All (1617 key)
GKS-2R	KS3-0088-H	Fire Service Key Switch, PH II, Horizontal, Remove 2 Pos (1617 key)
GKS-2RV	KS3-0088V	Fire Service Key Switch, Fire OP, PH II, RKR 3 Pos (1617 key)
GKS-3	KS3-00584, KS3-0057H	Fire Service Key Switch, PH I, Horizontal, Hall (1617 key)
GKS-3V	KS3-0057V	Fire Service Key Switch, PH I, Vertical, (1617 key)
GKS-4	KS1-0112H	Key Switch, round, Independent Service, Hall, (1601 key)
GKS-4V	KS1-0112V	Key Switch, round, Independent Service, Key #G1601X Vertical
GKS-5	KS1-0101H	Key Switch, round, OFF/ON Horizontal (1601 key)
GKS-6	KS1-0101V	Key Switch, round, OFF-ON vertical, removable both positions (1601 key)
GKS-7	KS1-0141H	Key Switch, Stop/Run horizontal (1601 key)
GKS-7V	KS1-0141V	Key Switch, Stop/Run, vertical (1601 key)
GKS-7R	KS1-0141H	Key Switch, Run/Stop, Red Round, Horizontal (1601 key)
GKS-7RV	KS1-0141V	Key Switch, Run/Stop, Red Round, Vertical (1601 key)
GKS-8	KS1-0096V	Key Switch, "ACCESS DN-OFF-UP", Vertical, round, black, (1612 key)
GKS-8H		Key Switch, 3pos Access Dn-Off-Up, Horizontal, black (1612 Key)
GKS-9	KS3-0087H	Fire Service Key Switch, PHI, "RESET-OFF-ON", horizontal (1617 key)
GKS-9A	KS3-0087V	Fire Service Key Switch, PHI, vertical "RESET-OFF-ON" (1617 key)
GKS-SPECIAL		Key Switch, Specify Markings, Positions, Key pull and Key number



Key Switches

S.E.E.S. #	O.E.M. #	Marking/Description
GKS-10H	KS1-0093H	Key Switch , Horizontal RKB Blank 2 Position Momentary 1 Remove (1613 key)
GKS-10V	KS1-0093V	Key Switch , Vertical RKB Blank 2 Position Momentary 1 Remove (1613 key)
GKS-11H	KS3-0097H	Key Switch , Horizontal RKR, 3P-R3, 1-AUTO-2-EMERG PWR, (1617 key)
GKS-11V	KS3-0097V	Key Switch , Vertical RKR, 3P-R3, 1-AUTO-2-EMERG PWR, (1617 key)
GKS-12V	KS3-0001V	Key Switch , Vertical RKR, 2P-R2, NORM, FIRE SERV, (2642 key)
GKS-12H	KS3-0001H	Key Switch , Horizontal RKR, 2P-R2, NORM, FIRE SERV, (2642 key)
GKS-13V		Key Switch , Vertical, 2P-R2 Off-On-Access, USE #2
GKS-13H		Key Switch , Horizontal, 2P-R2 Off-On-Access Round Black
GKS-14V		Key Switch , Vertical, 3P-Sprg Ret Cntr, UP Off-Down-Access, Black, Round, USE #2
GKS-15H	KS3-0005H	Key Switch , 3 POS, 2KP, Norm. Hold-Fire-Svc, Key 2642
GKS-16H	KS3-0005H	Key Switch , Horizontal, 2 POS, 2R, Off On Light, Key 1601
GKS-17H	KS1-0107H	Key Switch , Horizontal, 2 POS, 2R, Off On Fan, Key 1601
GKS-18H-SPECIAL		Key Switch , Horizontal, 2 POS, 2R, Off On, Special Marking, Key 1601
HAZ-KS-001	XCS-0K2A1-KLRK	Key Switch , 2 Position, Hazardous Areas
HAZ-KS-002	XCS-0S2A1-KLRK	Selector Cover Switch , Hazardous Areas
KAZ-KS-002	XCS-0S2A1-KLRK	Selector Cover Switch , 2 Positions, Hazardous Areas



GKS-10H



GKS-10V



GKS-11H



GKS-11V



GKS-12H



GKS-13V



GKS-14V



GKS-17H



GK-1

GK-2

Keys

S.E.E.S. #	O.E.M. #	Marking/Description
GK-1	G1612X	Key , 1612, for access or inspection
GK-2	G1613, KEY-0069N	Key , 1613, for spring return switches
GK-200	KEY-0063N	Key , Medeco "LF" Code
GK-201	KEY-0064N	Key , Medeco "FS" Code
GKS-1	G1601X, KEY-0067N	Key , 1601 Key
GKS-2A	G1617, KEY-0070N	Key , 1617 Key, Fire Service



GK-200



GK-201



GKS-1



GKS-2A

Car Signal Components



GB-1B-1



GB-100

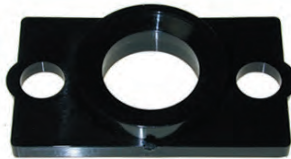

GB-1C



GB-1-ARROW



GB-1A-GREEN ARROW



ML-117



GDO-20A



GDO-20B



GDO-21

Pushbutton Module

S.E.E.S. #	O.E.M. #	Description
GB-1B-	PB1-	Pushbutton Module , button assembly complete, 2 N.O. contacts, 120v. Black halo/mounting plate with white illuminated button with black marking. Button cap 7/8" dia., halo 1-3/8" O.D., mounting holes 2" center to center. Vertical or horizontal mount. Specify marking, i.e. GB-1B-1
GB-1B-EMERGE-POWER		Pushbutton Assembly Complete , "Emergency Power" Indicator
GB-1B-HOSP-SERV		Pushbutton Assembly Complete , "Hospital Service" Indicator
GB-1B-SEISMIC		Pushbutton Assembly Complete , "Seismic" Indicator
GB-100	PB3-0007N	Pushbutton , VPMC11 2 N.O. Non-Illuminated SS 1/8 Cover
GB2-0137	PB2-0137N	Pushbutton , GAL, VPW 120V S.S Marked "Arrow" 2 N.O. Incandescent

Pushbutton Caps

S.E.E.S. #	O.E.M. #	Description
GB-1-	PB-1	Pushbutton Cap , white button with black marking, for pushbutton assembly. Button cap 7/8" diameter. Specify marking, i.e. GB-1-ARROW
GB-1C	PMDG-0066N	Halo , black, for pushbutton
GB-1D	PMDG-0067N	Halo , white, for RRB Push Button

Position Indicator Inserts

S.E.E.S. #	O.E.M. #	Description
GB-1A-	SFP-	Position Indicator Insert , white, round insert 1-1/8" dia. with black marking, specify marking, i.e. GB-1A-GREEN ARROW
ML-117		Neon Lamp Assembly , single, 120V neon "electric plug" style

Emergency Stop Switch Assembly

S.E.E.S. #	O.E.M. #	Description
GDO-20A	PB4-0001H	Pull to Stop , Emergency Stop Switch Module, collar is marked "PULL TO STOP/PUSH TO RUN". Eliminates accidental switch actuation.
GDO-20B	PB4-0020H	Stop Switch , Pull-Stop/Push-Run 2 N.O. - 1 N.C. Flat Insert-Muntz Cap
GDO-21	6073F4	Toggle Style , Emergency Stop Switch, 1 N.O., 1 N.C. PB6-0005V contacts. For vertical mount. Round, black insert/collar with red toggle and red markings "RUN" and "STOP" symbols

Car Signal Components

Emergency Stop Switch Assembly

S.E.E.S. #	O.E.M. #	Description
GDO-20	PB4-0011H	Push to Stop , Emergency Stop Switch Module, horizontal mount, 1 N.O., 2 N.C. (2 N.C. / 1 N.O. In Run Position) contacts. Round, black insert/collar with red button marked "STOP", collar marked "PUSH TO STOP/PULL TO RUN"
GDO-78	PB4-0019H	Pull-Stop/Push-Run button , VP 2 N.C. - 1 N.O., stainless steel



GDO-20



GDO-78

Limit Switches

S.E.E.S. #	O.E.M. #	Description
GDO-83	OP10-0004R	Switch Assembly , MOD Limit control, R.H.
GDO-90	OP10-0004L	Switch Assembly , MOD Limit control, L.H.
GDO-31	OP10-0005R	Contact Base Assembly , R.H. includes contact base and 3/8" silver contact screw 3/4" long, 12 required
GDO-31A	OP10-0005L	Switch Assembly, Contact Base Assembly , L.H. includes contact base and 3/8" silver contact screw 3/4" long, 12 required
GDO-301L	OP10-0001L	Switch Assy , Limit Control, 230V MOD with #35 Chain L.H.
GDO-301R	OP10-0001R	Switch Assy , Limit Control, 230V MOD with #35 Chain R.H.
GHE-200	SW5-0001N	Limit Switch , Type "LS" 1 N.C.
GLS-001	SW16-0001N	Switch , LD Limit, 2 N.C. Contacts
GLS-002	SW5-00020N	Switch , "LSO" Limit, 1 N.O. Contact
GLS-003	SW4-0002N	Switch , "LTD" Limit, 1 N.O. / 1 N.C. Contact
GLS-004	SW4-0001N	Switch , "LTS" Limit, 1 N.O. Contact
GLS-005	SW5-0003N	Switch , "LS" Limit, 1 N.C. Contact, Manual Reset



GHE-200

GLS-004

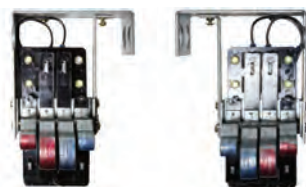

GDO-83

GDO-90



GDO-301L



GLS-001



GB-202

Emergency Equipment

S.E.E.S. #	O.E.M. #	Description
GB-100	PB3-0007N	Push Button , VPMC11 2 N.O. non-illuminated SS 1/8 Cover
GB-200	PMDG-0136N	Emergency Light Lens , white molded plastic, 6-1/2" x 3-1/4" replacement lens for GB-201
GB-201	EMER-0001N, EL-2, EL-4	Emergency Light Assembly , with battery MIS-194I
GB-201A	EMER-0007N, EL4NL	Emergency Light Assembly , New Version No Lights or Sockets
GB-201B	EMER-0034N	Emergency Light , with LED Board
GB-201C	EMER-0067N	PCB , LED for Emergency Light
GB-201E	EMER-0068AN	Emergency Light , with LED Board, EL-5
GB-202 ML-10	SW19-0003N,	Emergency Exit Switch , TOC button with keyswitch CTE-3 Lamp, 6.3, Watts 1.575, Bulb T-3/4, Mini Bayonet, M.O.L. 1.19
MIS-194Q	BAT-0003N	Battery , 6V, 4.6 AMP, 2.76" x 1.87" x 4.25"
MIS-194I	BAT-001N	Battery , 4.8V, 4.0 AH, 3-3/4" L x 2-1/2" H 5 D cells stacked 2 on 3. - See page 270.
MIS-194J		Battery , E Light 6V 10AH 6L-3.7, 5H-2W
MIS-194Q	BAT-0003N	Battery , 6V, 4.6 AMP, 2.76" x 1.87" x 4.25"



GB-200



GB-201



GB-201C



MIS-194I



MIS-194J

Printed Circuit Boards

S.E.E.S. #	O.E.M. #	Description
GPC-001	MOVFR-0001N	PCB, Main Door, Operator MOVFR Input PCBs Not Included
GPC-002	MOVFR-0002N	Auxiliary Input PCB for door operator
GPC-004	MOCT-0004L	PCB, MOCT enhanced without relays and fuses, L
GPC-005	MOCT-0004R	PCB, MOCT enhanced without relays and fuses, R
GPC-007	MOVFR-0070N	PCB, MOVFR II & MOVFRW II Main PC with (3) Input PCBs
GPC-008	MOVFR-0070N	Interface, PCB, MOD
GPC-009	DPPC-0001N	Chip, Door Protection Enabling
GPC-200	MOVFR-0072N	Drive, MOVFR II Operator Frequency 230 VAC, Includes Drive Ribbon Cable
GPC-203	MOVFR-0070N	PCB, MOVFR II & MOVFRW II MAIN PC w/ (3) Input PC Boards (W/4)
GPC-203A	MOVFR-0070N	PCB, MOVFR II & MOVFRW II MAIN PC w/out Input PC Boards (W/4)
GPC-204	GALX-1064AN	PCB, Traction Main I/O Revised
GPC-205	ECIA045.00012348	MOVFR 3.0 LCD Board Kit
GPC-206	2500-3050	PCB/Drive MOVFE, 230 VAC
G-TOOL-003	2500-3051	Parameter Tool, for MOVFE
GBPC-1	LED-00062	PCB, LED Red PB
GPC-207		MOVFR I to MOVFR II Conversion Kit, 115V
GPC-208		MOVFR I to MOVFR II Conversion Kit, 230V
GPC-209	MOVFR-0102N	MOVFR-0102N Board Kit, 230V



GPC-001



GPC-002



GPC-004



GPC-005



GPC-007



GPC-008



GPC-009



GPC-200



GPC-203

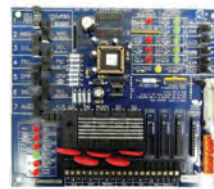

GPC-203A

GPC-205

Features & Benefits

The GPC-205 offers the very latest in door control technology, including advancements in power management providing for longer service life. State of the art design includes no removable modules or relays, eliminating intermittent failures and unnecessary field service labor.

The new design simplifies parameter adjustments and diagnostics through the on-board LCD display, while eliminating the need of a hand held tool. The main control board and elevator specific variable frequency drive greatly reduces field set-up labor.

- Identical foot print application, fit, form and function, for replacing MOVFR I & MOVFR II
- On-board LCD display - parameter adjustment in real time "no hand-held tool required for parameter adjustment".
- User friendly LCD rotation - work from either side of the operator.
- On-board LED function indicators.
- Job specific variable frequency drive board - advanced design reduces heat for superior drive efficiency.
- Universal input voltage - no plug-in modules required, reducing maintenance cost.
- Door detector enabled through LCD display - no chip purchase required.
- Control board contains no antiquated removable modules or relays, utilizing current state of the art components, further reducing wasted field service labor.

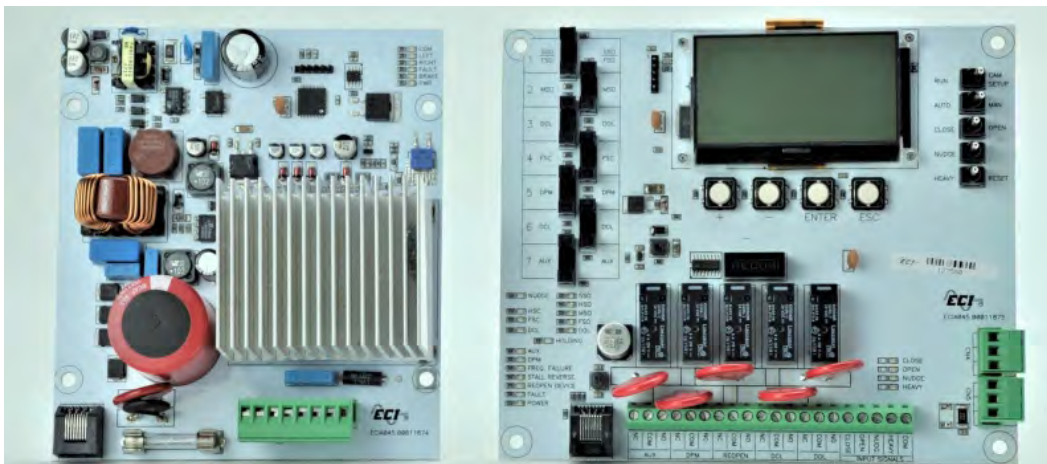

VARIABLE FREQUENCY DRIVE

LOGIC CONTROL BOARD

Timers

S.E.E.S. #	O.E.M. #	Description
GT-1	0A4G	Electronic Tube for Tube Type Timers #10041
GT-2	TMR-0001N, 10121-1, 10121-3	Solid State Timer , Replacement for Single and Double Potentiometers, .01 to 640 sec. Replaces tube type timers #10041-1, #10041-2, #10041-3 and #10041-4
GT-2A	TMR-0008N	Hardware Kit only , for GT-2 Timer
GT-2B		Kit , GT-2 and GT-2A Timer with Hardware



GT-1



GT-2



GT-2A

Coils

S.E.E.S. #	O.E.M. #	Description	I.D.	O.D.	C/C	STYLE
GC-1	5632	Coil , 265 VDC	7/8	1-3/4	2-1/4	A
GC-2	5693	Coil , 208/220 VAC	7/8	1-3/4	2-1/4	A
GC-3	5631	Coil , 230 VDC	15/16	2-1/4	2-5/8	A
GC-4	5630	Coil , 265 VDC	1-1/8	2-13/16	3-5/16	B
GC-5	5785	Coil , 230 VDC	1-1/16	2-3/8	3	B
GC-6	6437	Coil , 265 VDC	1-1/8	1-7/16		C
GC-7	5744	Coil , 230 VDC	3/4	1-3/4	2-1/4	A
GC-8	5761	Coil , 1.4 Ohm	1-3/16	2-13/16	3-1/4	B
GC-9	6439	Coil , 85 VDC	5/8	1-7/16		C
GC-10	6438	Coil , 230 VDC	5/8	1-7/16	7/8	C
GC-11	6202	Coil , 130 VDC	1-3/16	2-13/16		B
GC-12	6779N	Coil , 265 VDC	1-1/5	2-1/5		D



GC-10



GC-11



GC-12



GDO-304



GDO-304A



GDO-305

Contacts

S.E.E.S. #	O.E.M. #	Description
GDO-304	INT22-0020N	Contact Kit , "N"/"SN" Interlock Lower
GDO-304A	INT22-0019N	Contact Kit , "N"/"HNA" Interlock Upper
GDO-305	INT8-0008N	Cover , SMD Lock & Contact
GRP-1	LC-0029L, LC-25-#8	Movable Contact , Left Hand
GRP-2	LC-25-#7, LC-0029R	Movable Contact , Right Hand
GRP-3	CONT-0002N, LC-16-#22	Stationary Contact , Silver 3/8", 3/4" thread length, 15/16" O.L.
GRP-3A	LC-26-#9, CONT-0002N	Stationary Contact , Silver 3/8", 3/8" thread length, 9/16" O.L.



GRP-2



GRP-3



GRP-3A

Contacts

S.E.E.S. #	O.E.M. #	Description
GRP-4	CONT-0001N, LC-16-#23	Stationary Contact , Carbon 3/8", 3/4" thread length, 1-1/4" O.L.
GRP-5	LC-16-18, LC-0003N	Main contact holder , 3/8"
GRP-6	LC-0016N	Copper Contact , 1-3/4" dia. x 3/8" thick with 1" stem
GRP-7	LC-0015N	Copper Contact , 1-1/2" dia. x 5/16" thick with 1" stem
GRP-8	LC-0018N	Copper Contact , 1" diameter x 5/16" thick with 1" stem
GRP-9	CONT-0009N	Carbon Contact , 1-3/4" dia. x 1"
GRP-9A	LC-0041N	Holder for Carbon Contact 1-3/4" diameter, thread 1/2-13
GRP-9B	LC-0041N	Supporting Stud for GRP-9A, 1/2-13 Female w/ 3/8-16 Stud
GRP-9S	LC-0097N	Supporting Stud for GRP-9A holder
GRP-10	CONT-0008N	Carbon Contact , 1-1/2" dia. x 7/8"
GRP-10A	LC-0083N	Holder for Carbon Contact 1-1/2" diameter, thread 3/8-16
GRP-11	CONT-006N	Carbon Contact , 1" diameter x 3/4"
GRP-11A	LC-0042N	Holder for Carbon Contact 1" dia., thread 5/16
GRP-11S	LC24.1-47, LC-0098N	Supporting Stud for GRP-11A holder
GRP-14	LC-7.1-12A	N.C. Contact Post assembly , 2-3/4"
GRP-18	LC-7.1-18A, LC-0090N	N.O. Contact Post assembly , 3-1/4"
GRP-19	LC-7.1-50A, LC-0095N	Supporting Stud for GRP-10A holder
GRP-38	LC-28-8, LC-0085N	N.O. Contact Post assembly , 1-7/8"
GRP-39	LC-28-9, LC-0084N	N.O. Contact Post assembly , 1-7/16"
GRP-40	LC-28-10, LC-0082N	N.C. Contact Post assembly , 1-5/8"
GRP-44	INT3-0010N	Contact , MOW/MOX bridging Yellow Zinc
GRP-45	INT5-0015N	Contact kit , M interlock lower
GRP-47	LC-0090N	Post , 3-1/4", LG contact

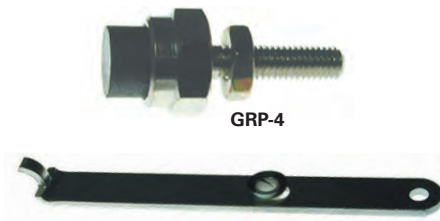

GRP-4



GRP-5



GRP-6



GRP-7



GRP-8

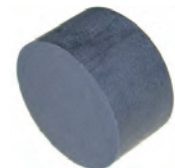

GRP-9



GRP-9A



GRP-9S



GRP-14



GRP-18



GRP-19



GRP-40



GRP-44



GRP-45



GRP-47

Relay Parts



GRP-13

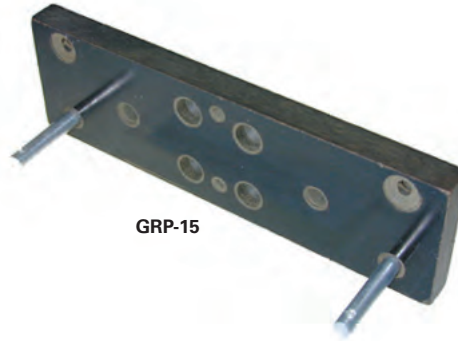

GRP-15



GRP-16



GRP-32A

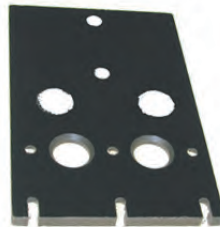

GRP-36

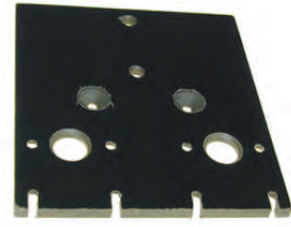

GRP-37



GRP-33



GRP-34



GRP-35

Contact Plates

S.E.E.S. #	O.E.M. #	Description
GRP-13	LC-7.1-9, LC-0075N	Plate for Auxiliary Contact, N.C.
GRP-15	LC-7.1-13, LC-0059N	Plate 1 for Main Contact
GRP-16	LC-7.1-14, LC-0076N	Plate 2 for Auxiliary Contact, N.O.
GRP-32A	LC-25#2, LC-0078N	Contact Plate
GRP-33	LC-28-2, LC-0056N	Contact Plate, (2) Main, (0) Auxiliary
GRP-34	LC-28-3, LC-0057N	N.O. Contact Plate, (2) Main, (1) Auxiliary
GRP-35	LC-28-4, LC-0058N	N.O. Contact Plate, (2) Main, (2) Auxiliary
GRP-36	LC-28-5, LC-0078N	N.C. Contact Plate, (3) Contacts
GRP-37	LC-28-6, LC-0076N	N.C. Contact Plate, (4) Contacts

Relay Parts

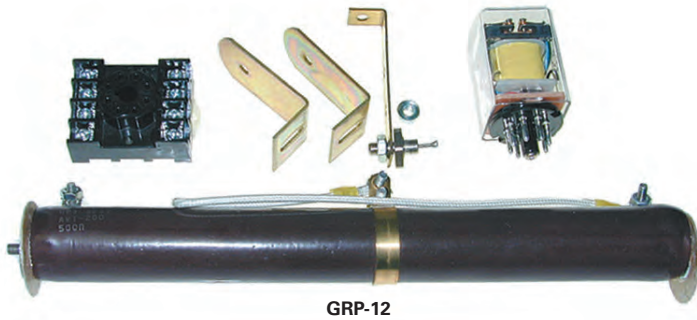

GRP-42

GRP-49

S.E.E.S. #	O.E.M. #	Description
GRP-12	250-30, LC56-0001N	Relay, replacement kit to replace Ward Leonard "CC" or "HC"
GRP-20	LC-7.1-55, LC-0014N	Flexible Connector, #8 Wire, 13-1/4"
GRP-22	LC-8.1-60, LC-0105N	Knurled Rivet, F.H. 1/4" x 1-1/2"
GRP-23	LC-8.1-62	Compression Spring
GRP-24	LC-8.1-63	Spring Washer
GRP-25	LC-8.1-64	Cotter Pin
GRP-26	LC-8.1-65, LC-0014N	Flexible Connector, #8 Wire, 15-1/4"
GRP-28	LC-23.1-21	Rivet, F.H. 3/16" x 1-1/4"
GRP-29	LC-23.1-52	Compression Spring
GRP-30	LC-23.1-53	Spring Washer
GRP-31	LC-23.1-54	Cotter Pin
GRP-41	LC-28-11	Terminal Stud Assembly
GRP-42	LC-28-17, LC-0104N	Main Contact Spring Assembly
GRP-43	LC-28-20, LC-0011N	Flexible Connector, #14 Wire, 13-1/2"
GRP-49	LC-0137N	Bracket & Spring, Kick Off for Relays LC28, LC49, & LC49P
GRP-200	LC-0105N	Spring Assembly, 7/8", 1-1/2" for Main Contacts
RES-59	974435	Resistor, Adjustable, 250 OHM 20 OW



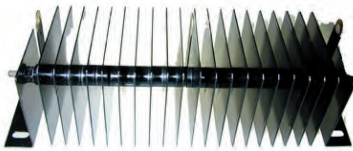

GR-1



GS-1

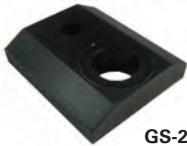

GS-2



GS-2A



GS-3

S.E.E.S. #	O.E.M. #	Description
GR-1	C44S10D1H11G, DIOD-0019N	Doublers , 20 plates, 2" x 4"
GR-2	C11S10D1H11G	Doublers , 20 plates, 1.3" x 1.3"

S.E.E.S. #	O.E.M. #	Description
GS-1	SEL-0086N	Selector contact brush , with spring and nuts
GS-2	SEL-0001N	Selector segment holder for #3
GS-2A		Selector Segment , Bottom Half for #3
GS-2B	SEL-0023N	Selector Holder Assembly Segment (GS-2 & GS-2A)
GS-3	GALX-0307N	Tape Guide , for GAL Selector

Guide Rollers

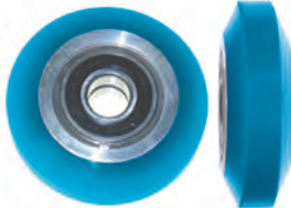

GW-1

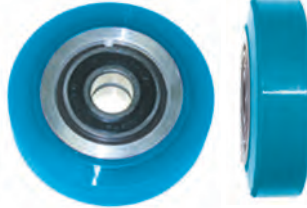

GW-1A



GW-2



GW-2A



GW-3

S.E.E.S. #	O.E.M. #	Description
GW-1	377-12	Roller Guide Wheel , 3-1/4" O.D. with 1/2" face, 2 bearings, .6693" I.D.
GW-1A	377-13	Roller Guide Wheel , 3-1/4" O.D. with 3/4" face, 2 bearings, .6693" I.D.
GW-2	378-12	Roller Guide Wheel , 6" O.D. with 1/2" face, 2 bearings, .6693" I.D.
GW-2A	378-13	Roller Guide Wheel , 6" O.D. with 3/4" face, 2 bearings, .6693" I.D.
GW-3	SW1-0007N	Roller and Bolt , Roller 1.25" O.D. x 1/2" W, Bolt 1.40" L x .43" W, for gate switch
HWW-001	377-14	Roller Guide Wheel , Hollister Whitney, 3-1/4" diameter face roller, .420" face
HWW-001A	377-15	Replacement Wheel , 3-1/4" Dia. Hollister Whitney side roller, .665" face, for HWRG-001
HWW-002	378-14	Roller Guide Wheel , Hollister Whitney, 6" diameter face roller, .430" face
HWW-002A	378-15	Roller Guide Wheel , Hollister Whitney, 6" diameter side roller, .865" face
HWMP-001		Eyebolt Slotted Plunger , #92 Disc Brake
HWMP-002		Eyebolt Housing , #92 Disc Brake
HWMP-003	207-092	Solenoid , Remote Trip Pin
HWMP-004	207-087	Solenoid Assembly , Resettable Governor
HWMP-63		Split Seal Kit , Hollister, 63 Machine

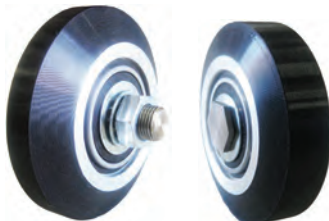

HWW-001



HWW-001A



HWW-002



HWW-002A

HAUGHTON

QUICK LOCATOR GUIDE

Belts	650
Brushes	652
Capacitor	664
Car Signal Components	650
Button Components	650
Key Switches and Keys	650
Coils	651-652
Gongs	650
Door Parts and Equipment	653-656
Contacts	656
Door Clutch Roller Assemblies	655
Key, Lunar	653
Photo Cell Components	653
Resistors	655
Safe Ray System Components	653
Safety Edge Assembly	655-656
Sheaves	654
Machine Parts	657
Seals, Gaskets, Bearings	657
Tachometers	657
Motors	654, 657
Printed Circuit Boards	664
Rectifiers	658
Relay Parts	658-663
Contacts	658-662
Magnetic Leveling Switches	658
Optical Leveling Switches	658
Plug-in Relays	659
Telephone Type Relays	663
Resistors	655, 664
Stepper Switches	664
Timers	664
Transformers	664
Wheels and Rollers	665-667
Door Clutch Roller Assembly	655, 665
Hanger Rollers	665-666
Interlock Roller	656, 665
Limit Switch Roller	658, 667
Roller Guide Assemblies	666-667
Roller Guide Wheels	666-667
Tach Roller	667

HAUGHTON

Car Signal Components



HB-1



HB-1B



HB-1C

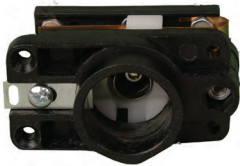

HB-1D



HB-3



HB-4



HK-1



HK-2



HK-3



HK-4



HBLT-1



HBLT-2



HB-2

S.E.E.S. #	O.E.M. #	Description
HB-1-	3-40080-	Button for type "H" pushbutton assembly. White button with black marking, face 1-3/32" diameter x 1-3/32" long. Specify marking, i.e. HB-1-3
HB-1-BLANK-ADA		Button , Type H, Blank ADA
HB-1B	3-40218-14	Collar , black for type "H" buttons
HB-1C	3-40150-54	Switch Element , 2 N.O., "H" button
HB-1D	3-40229-36	Button , switch element assembly "H" series 1 N.O. & 1 N.C.
HB-3	3-400063-32	Halo , red "RUN-STOP" for toggle switch
HB-4	3-40218-98	Lens , Hall lantern lens, 3" diameter, white
HKB-1	3-40078-11	Key Switch Bezel , Red
HKB-2	3-40078-18	Key Switch Bezel , Black
HK-1	3-40079-51	Key , 332CLC key code
HK-2	3-40216-69	Key , Haughton XX3117 key
HK-3		Fire Service Key , barrel ACE type
HK-4	#2007	Key , Haughton car cop key #2007
HK-5	AE102	Key , Emergency Car Call AE102
HK-5	AE102	Key , Emergency Car Call AE102
HK-6		Key , Haughton Esc #T112, Up-Down Direction Run
HK-7		Key , AE101
HK-8		Key , AE103
HK-9		Key , AE104
HK-10		Key , AE105

Belts

S.E.E.S. #	O.E.M. #	Description
HBLT-1	3-40133-54	Belt for door operator, Poly-V-Belt type 6J, 55"
HBLT-2	3-40139-87	Belt for limit switch, Poly-V-Belt type 4J, 43"

Gongs

S.E.E.S. #	O.E.M. #	Description
HB-2	3-40026-99	Gong Assembly , 12 VDC

Coils



HC-1 thru HC-17

I.O. 5/8" x 13/16"
O.D. 1-59/64" x 2-1/8"
Length 1-9/32"



HC-14



HC-18, HC-19, HC-20



HC-21, HC-22

S.E.E.S. #	O.E.M. #	Resistance	Voltage
HC-1	E-2D*	3-23015-09	5,000 230 VDC
HC-2	E-11*	3-23015-23	818 115 VDC
HC-3	E-12	3-23015-10	60 120
HC-4	E-12G**	3-23015-21	60 110
HC-5	E-16	3-23015-04	31 110/55
HC-6	E-20	3-23015-24	187 220/250
HC-7	E-20G**	3-23015-20	187 208
HC-8	E-23*	3-23015-22	3,240 230 VDC
HC-9	E-24	3-23015-16	230 220/240
HC-10	E-24G**	3-23015-19	230 220/240
HC-11	E-26	3-23015-05	145 208/220
HC-12	E-26C*	3-23015-05	95 208/240
HC-13	E-26G**	3-23015-01	145 208/220
HC-15	E-45*	3-23015-17	1,350 115/440
HC-16	E-46	3-23015-06	600 115/440
HC-17	E-48	3-23015-18	920 220/440

*O.D. is 2-11/64" x 2-3/8"

**High temperature applications



HC-23, HC-24, HC-27



HC-25, HC-29



HC-26, HC-28

S.E.E.S. #	O.E.M. #	Resistance	Voltage	Dimensions
HC-14	E-26T, 3-23015-02	Inner winding: 300 Outer winding: 3,400	208/220	5/8" x 13/16" I.D. x 2-11/64" x 2-3/8" O.D. x 1-9/32" L

S.E.E.S. #	O.E.M. #	Resistance	Voltage	Dimensions
HC-18	F-1, 23036	370		1-11/32" I.D. x 3-1/8" O.D. x 2-13/16" L
HC-19	F-2, 23036A	4,500		1-11/32" I.D. x 3-1/8" O.D. x 2-13/16" L
HC-20	F-12, 3-41032-002	450		1-11/32" I.D. x 3-1/8" O.D. x 2-13/16" L
HC-21	K-1, 3-36271-01	795		2-7/64" I.D. x 2-13/16" O.D. x 2-13/16" L
HC-22	K-2, 3-36271-00	2,900		2-7/64" I.D. x 2-13/16" O.D. x 2-13/16" L
HC-23	T-1, 3-36102-13	700	115 VDC	1" I.D. x 2" O.D. x 2-5/8" L
HC-24	T-2, 3-36102-15	2,940	230 VDC	1" I.D. x 2" O.D. x 2-5/8" L
HC-27	T-18, 3-36102-06	1,900	230 VDC	1" I.D. x 2-5/8" O.D. x 2-1/4" L
HC-25	T-8, 3-36102-07	740	80	1" I.D. x 2-1/4" O.D. x 2-3/8" L
HC-29	T-90, 3-36102-02	Field current sensitive 1.7 - 4.0 Amp		1" I.D. x 2-5/8" O.D. x 2-3/8" L
HC-26	T-15, 36102	780	115 VDC	1-1/2" I.D. x 2-1/4" O.D. x 2-5/8" L
HC-28	T-25, 3-36102-01	2,900	230 VDC	1-1/2" I.D. x 2-1/4" O.D. x 2-5/8" L

Coils

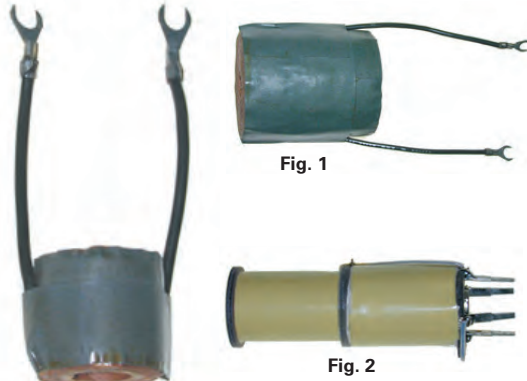

HC-30, HC-31



HC-47

HC-48

HC-49, HC-50



HC-52



HC-51

S.E.E.S. #	O.E.M. #	Resistance	Dimensions
HC-30	23023A	70	33/64" I.D. x 1" O.D. x 15/16" L
HC-31	23023C	265	33/64" I.D. x 1" O.D. x 15/16" L

S.E.E.S. #	O.E.M. #	Fig.	S.E.E.S. #	O.E.M. #	Fig.
HC-32	34-1032-001	1	HC-33	34-1032-006	2
HC-34	34-1032-003	1	HC-34A	34-1032-004	2
HC-34B	34-1032-005	1	HC-38	3-40155-15	2
HC-35	3-40258-34-1	1	HC-39	3-40255-08	2
HC-40	34-1032-007	1	HC-41	34-1032-009	2
HC-42	34-1032-010	1	HC-43	34-1032-011	2
HC-44	34-1032-012	1	HC-46	34-1032-002	2

S.E.E.S. #	O.E.M. #	Description
HC-47	3-40031-88	Brake coil for OH Machine, Motor is flange style, no feet, bolts via ring. I.D. 2-3/8" x 2-3/8", 167 OHMS
HC-48	3-23044-01	Brake coil for EK Machine, Motor with feet and is mounted to machine frame. I.D. 3-1/8" Sq. x 3" H, 110 OHMS, 120 VDC, I.D. 3/4"
HC-49	3-40008-47	Coil , 12V, EN (green) bobbin type coil for type BN and DN relays. <i>See page 662.</i>
HC-50	3-40008-48	Coil , 24V, DN (red) bobbin type coil for type BN and DN relays. <i>See page 662.</i>
HC-51	23031	Coil , B1 for B7 retiring cam, I.D. 1-17/32" min to 1-5/8" max., 330 Ohms
HC-52		Replacement , 110V coil for FRP-75
HC-53	26187	Brake Coil
HC-54	23039	Brake Coil

Brushes

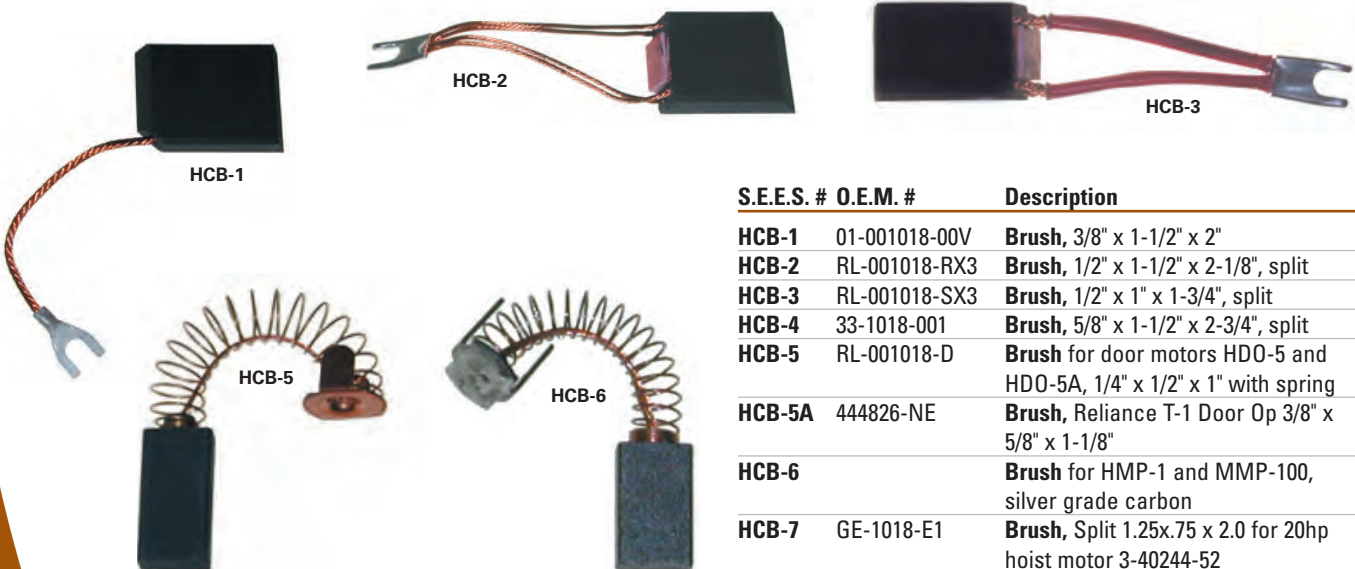

S.E.E.S. #	O.E.M. #	Description
HCB-1	01-001018-00V	Brush , 3/8" x 1-1/2" x 2"
HCB-2	RL-001018-RX3	Brush , 1/2" x 1-1/2" x 2-1/8", split
HCB-3	RL-001018-SX3	Brush , 1/2" x 1" x 1-3/4", split
HCB-4	33-1018-001	Brush , 5/8" x 1-1/2" x 2-3/4", split
HCB-5	RL-001018-D	Brush for door motors HDO-5 and HDO-5A, 1/4" x 1/2" x 1" with spring
HCB-5A	444826-NE	Brush , Reliance T-1 Door Op 3/8" x 5/8" x 1-1/8"
HCB-6		Brush for HMP-1 and MMP-100, silver grade carbon
HCB-7	GE-1018-E1	Brush , Split 1.25x.75 x 2.0 for 20hp hoist motor 3-40244-52

Door Parts and Equipment



HDO-1



HDO-2A



HDO-2



HDO-2B



HDO-2E



HDO-2G

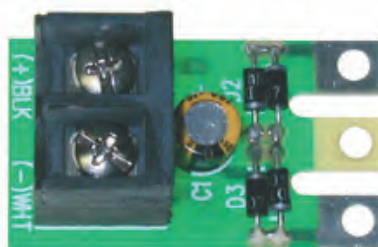

HDO-2F



HDO-2C

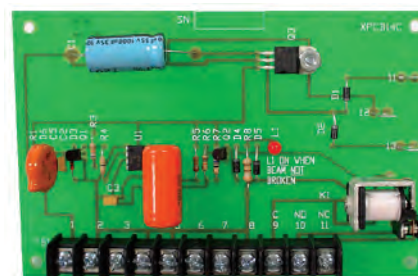

HDO-2D

S.E.E.S. #	O.E.M. #	Description
HDO-1	34-2551-28	Lunar key, fits escutcheon 3-40197-17
HDO-2B	3-40007-66	Photo cell assembly with 20 ft. cable
HDO-2C	3-40007-63	Coiled cord assembly for Safe Ray Light
HDO-2	3-401040-47	Light source and cable assembly
HDO-2G		Emitter Replacement Kit for HE Safe Ray Systems, solid state technology, replaces (2) incandescent light sources
HDO-2E		Emitter source assembly, included in HDO-2G kit
HDO-2F		Power supply printed circuit board, included in HDO-2G kit
HDO-2D	3-40007-82	Amplifier PC Board, for type "HE" safe ray

Door Parts and Equipment



HDO-5



HDO-6



HDO-7

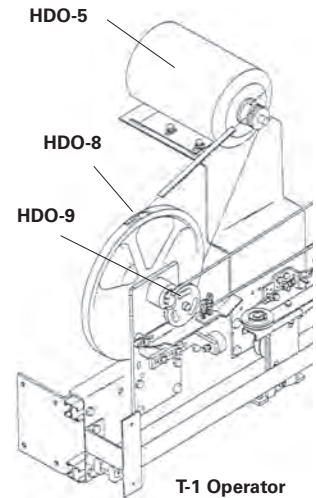

T-1 Operator

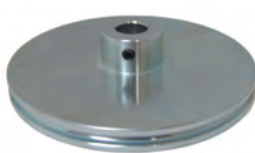

HDO-9

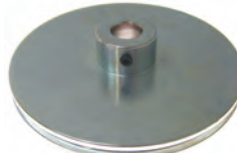

HDO-9A



HDO-10B

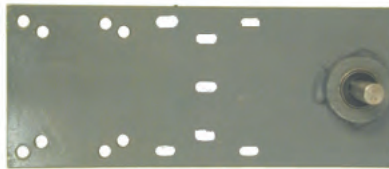

HDO-10



HDO-10A



HDO-11



HDO-12



HDO-13, HDO-13A



HDO-14



HDO-15



HDO-16



HDO-17

S.E.E.S. #	O.E.M. #	Description
HDO-5	3-40144-36	Motor, door operator, 1/4 HP, 230 VDC 1140 RPM, uses HCB-5 brushes (T-1), shaft 5-8"
HDO-5A	3-40196-50	Motor, door operator, 1/2 HP, 230 VDC, 1140 RPM (T-H), shaft 3/4"
HDO-5B		Sheave, 1.75" O.D., 5/8" I.D., 1-14" L
HDO-5C		Sheave, 1.25" O.D., 5/8" I.D., 1-14" L CTR PT
HDO-6	3-40151-13	Drive Sheave, 12" assembly for single speed doors
HDO-7	3-40151-14	Drive Sheave, 12" assembly for two speed doors
HDO-8	3-40132-72	Drive Sheave, 12" for above assemblies, 6 "J" grooves
HDO-9	3-40132-68	Sheave, 4" cable drive sheave
HDO-9A	3-40132-69	Idler Sheave, for T1 operator
HDO-10B	3-40129-08	Sheave, 2-1/2" for T1 operator
HDO-10	3-40132-81	Shaft, bearing bracket assembly
HDO-10A		Bearing, only, for HDO-10 assembly
HDO-11	3-19538-03	Cam
HDO-12	3-40130-33	Contact arm
HDO-13	3-28763-02	Moving contact bridge
HDO-13A	3-40304-67	Moving contact bridge, silver
HDO-14	34-1166-003	Spring, limit switch for HDO-17
HDO-15	34-1166-004	Spring, limit switch
HDO-16	16562	Contact, stationary
HDO-17	10084	Contact assembly, (6 sets) for limit switch

Door Parts and Equipment

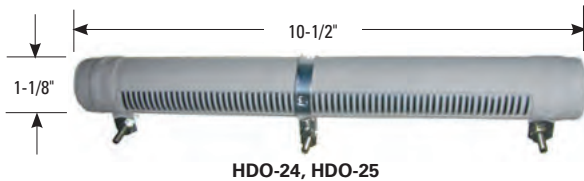
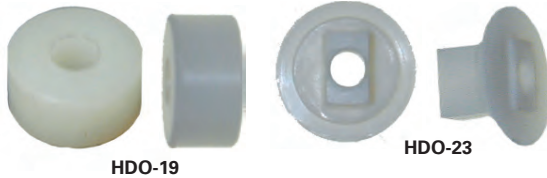

S.E.E.S. #	O.E.M. #	Description
HDO-18	34-0868-002	Contact arm for HDO-17 assembly
HDO-19	19474	Roller, limit switch for HDO-17 assembly
HDO-23	3-28764-02	Guide, contact, nylon
HW-11	35-1229-03	Idler sheave for car door hangers and safety edge retraction unit, 1-7/8" O.D., 1/2" bearing I.D.
HDO-24	3-26103-00	Resistor, 10 Ohm, 190 Watt
HDO-25	3-26103-05	Resistor, 20 Ohm, 190 Watt
HDO-44	3-40134-44	Door Clutch Roller, 3-40136-44, and arm left
HDO-45	3-40136-45	Door Clutch Roller, 3-40136-45, and arm right

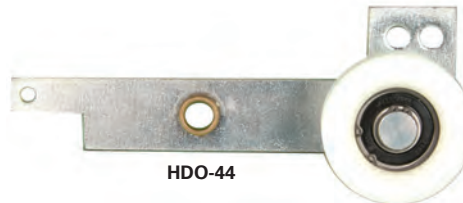

Safety Edge Assembly

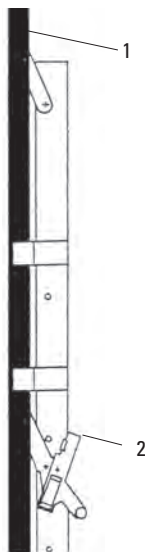

Item	S.E.E.S. #	O.E.M. #	Description
1	HDO-26	3-40041-87	Nosing, safety edge, 7 ft. aluminum
2	HDO-27	3-40157-90	Link assembly, lower L.H., safe edge
	HDO-28	3-40157-90	Link assembly, lower R.H., safe edge
	HDO-28A	3-40158-78	Upper pivot assembly, for safe edge



Door Parts and Equipment



HDO-29



HDO-30



HDO-31



HDO-32



HDO-36



HDO-33



HDO-37



HDO-37A



HDO-38



HDO-37B



HDO-38A

HDO-38B



HDO-39



HDO-4

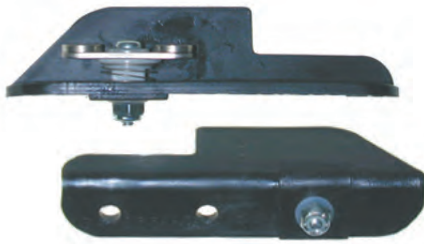

HDO-52

S.E.E.S. #	O.E.M. #	Description
HDO-29	HA-660-H	Sleeve bearing, teflon, 0.400" long x .752" O.D. x .479" I.D.
HDO-30	HA-660-F, 3-40235-40	Sleeve bearing, teflon, 1.010" long x .752" O.D. x .479" I.D.
HDO-31	3-40129-53	Sleeve bushing, steel, .526" long x .497" O.D.
HDO-32	34-1167-006	Spring, safety edge, 9-1/8" O.L.
HDO-33	3-40157-32	Spring, safety edge, 6-9/16" O.L.
HDO-34	3-40106-41	Spring, safety edge, 10" O.L.
HDO-36	19492	Roller, safety edge, nylon, 1.13" O.D., .50" I.D., .39" Thick
HDO-37	3-40117-56	Contact, R.H., stationary, M. interlock
HDO-37A	35-2551-25	Replacement Contact, 2-1/2" L, R.H.
HDO-37B	35-2551-24	Replacement Contact, 1-1/4" L, R.H.
HDO-38	3-40117-57	Contact, L.H., stationary, M. Interlock
HDO-38A	35-2551-26	Replacement Contact, 2-1/2" L, L.H.
HDO-38B	35-2551-23	Replacement Contact, 1-1/4" L, L.H.
HDO-39	3-40130-19	Bushing, 1" O.D., .50" I.D., 1.20" Thick Interlock Rubber Stop For "M" Interlock
HDO-4	3-40341-12, 3-19239-01	Movable contact assembly
HDO-52	3-40092-04	Interlock contact assembly, R.H.
HDO-52A	34-2551-004	Bracket for interlock contact, R.H.
HDO-53	3-40092-05	Interlock contact assembly, L.H.
HDO-53A	34-2551-005	Bracket for interlock contact, L.H.
HW-1-R	J825R	Interlock Roller, roller only, no pin

Machine Parts

Tachometer

S.E.E.S. #	O.E.M. #	Description
HMP-1A		Brush Cap for HMP-1 Tachometer
HCB-6		Brush for HMP-1 & MMP-100, silver grade carbon
HW-17	3-40010-13	Tachometer roller, 3-1/2" aluminum hub, 5/16" I.D.
HMP-14	3-40146-49	Seal, tach shaft for HMP-1 Tachometer
HMP-16	29014	Spreader, Bracket for 16" Gov Type "W"

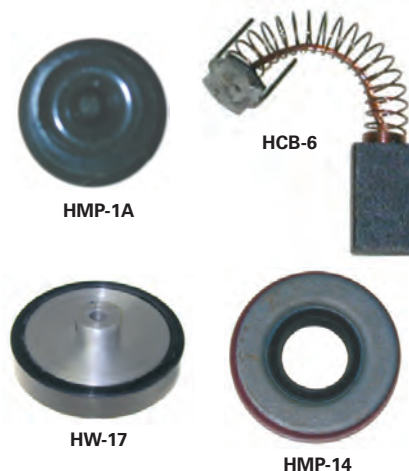

"EK" Machine

S.E.E.S. #	O.E.M. #	Description
HMP-2	3-40147-21	Gasket, worm shaft
HMP-3	3-40151-88	Thrust bearing, worm shaft
HMP-4	3-40151-89	Drum shaft bearing, gear side
HMP-5	3-40151-87	Drum shaft bearing, drum side
HMP-6	3-40148-75	Felt seal for drum shaft, 2 required
HMP-20		Thrust Bearing, Kit SKF7412-BG1
HPAC-2	3-40360-86	Worm shaft seal, split, I.D. 2-3/4"
HPAC-3	3-20031-02	Seal Seat, 3-1/4" x 2-3/16"



"OH" Machine

S.E.E.S. #	O.E.M. #	Description
HMP-7	3-40003-42	Drum shaft bearing
HMP-8	3-40003-87	Seal for drum shaft
HMP-9	3-40003-40	Worm shaft bearing
HMP-10	3-40003-55	Gasket shim, .032"
HMP-11	3-40003-51	Gasket shim, 1/64"
HMP-12	3-40143-15	Sheave shaft for governor, 12-3/4"
HMP-13	3-40248-45	Flexible Coupling for "OH", "EK" machine
HPAC-1	3-40360-87, 3-40003-79	Worm Shaft Seal, split, I.D. 2-1/4"

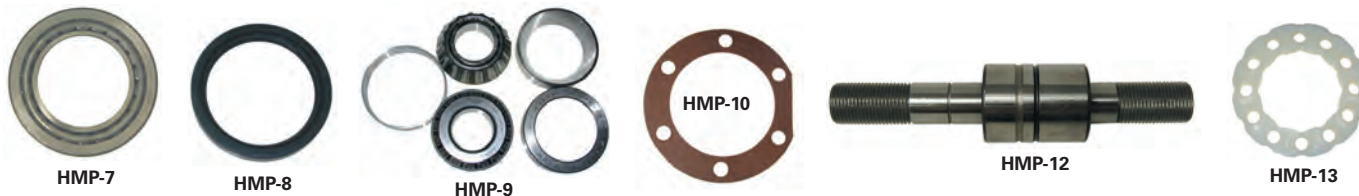

Motors

S.E.E.S. #	O.E.M. #	Description
HS-1	16873	Vernier pressure washer
HS-2	14739	Vernier clutch washer, bronze
HS-3	3-26123-00	Drive Motor, Vernier B1, 72 RPM, 120V
HS-3A	3-26123-12	Drive Motor, Vernier B1, 72 RPM 230-240 VAC

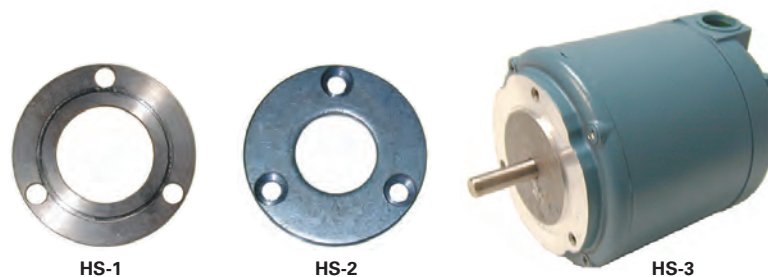

Rectifiers



HRT-1



HRT-2

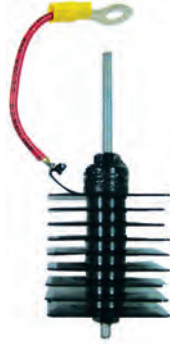

HRT-3

S.E.E.S. #	O.E.M. #	Description
HRT-1	3-36213-09	Door Rectifier, 7 plate 3" L
HRT-2	3-40155-28	Rectifier, 6 AMP 800V 3 phase bridge
HRT-3	3-36213-04	Selenium Rectifier, 1/2 wave hot stud 9plates with 3-1/2" leads
HRT-4	33-1094-008	Rectifier, Selenium 3PH, 5 Ter8-3/8" L 30 Plates 165VAC@750ma

Relay Parts



HRP-1A

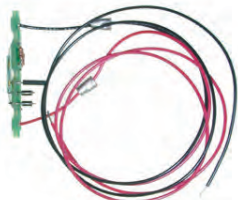

HRP-1AB

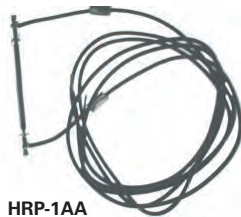

HRP-1AA

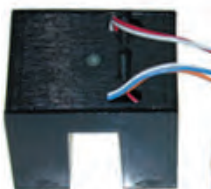

HRP-1B

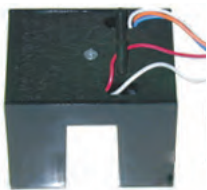

HRP-1D



HRP-3



HRP-3C

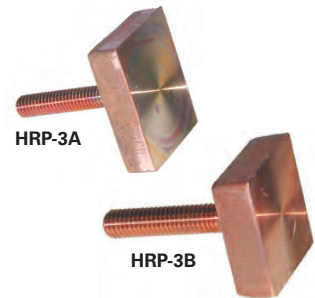

HRP-3A

HRP-3B



HRP-12A

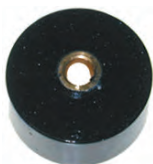

HRP-12B



HRP-12C

Magnetic Leveling Switches

S.E.E.S. #	O.E.M. #	Description
HRP-1	3-40156-88, 35-2557-15	Magnetic Leveling switch, mechanical style switch
HRP-1A	3-40156-89, 35-2557-17	Magnetic Leveling switch, electronic style switch

Repair Kits for Magnetic Switches

S.E.E.S. #	Description
HRP-1AA	Repair Kit for HRP-1, Replacement reed assembly with detailed instructions
HRP-1AB	Repair Kit for HRP-1A, Replacement reed printed circuit board assembly with detailed instructions

S.E.E.S. #	O.E.M. #	Description
HRP-1B	3-40230-10	Optical Leveling switch, 24 VDC, single beam
HRP-1C	3-40341-77, 3-40025-75	Optical Leveling switch, 110 VDC, dual beam
HRP-1D	3-40341-73	Optical Leveling switch, 24 VDC, dual beam
HRP-3	5737	Carbon contact, copper base, 1.70" L, 1.50 W, .75" thick
HRP-3A	5736	Copper contact, 1-1/2" square head
HRP-3B	5574	Copper contact, 1-3/4" x 2" x 1/2" thick
HRP-3C	5575	Carbon contact, 1-3/4" x 2" x 3/4" thick
HRP-12A	3-40119-03	Roller and arm assembly, for "J" limit switch
HRP-12B	26359	Roller, rubber for "J" limit switch, 1.62" O.D., .30" I.D., .75" thick
HRP-12C	3-40129-24	E-clip for HRP-12A roller

Relay Parts

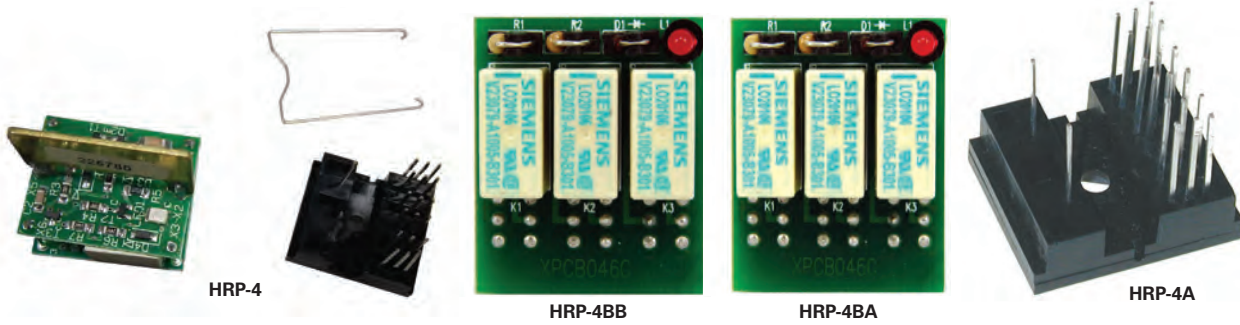

Ice Cube Relay

S.E.E.S. #	O.E.M. #	Description
HRP-4	3-40008-67	Relay, plug-in, 6 PDT, 24V
HRP-4BB		Solid State Replacement for HRP-4
HRP-4BA		Solid State Replacement for HRP-4B
HRP-4A	3-40008-75	Socket for relay
HRP-45	3-40014-98	Lamp, 28V, power supply indicator replacement lamp assembly
MIS-204D	3-40008-73	Rectifier, 3 Phase, 600V, 27.5 amp
MIS-204F		Rectifier, 3 Phase, 1200V, 25 amp
PR-53	157-23-P200, KUP-14A15-12	Relay, plug-in, 3 PDT, 12 VAC
PR-72	157-23-Q200, KUP-14A15-24	Relay, plug-in, 3 PDT, 24 VAC
PR-14	157-23-T200, KUP-14A15-120	Relay, plug-in, 3 PDT, 120 VAC
PR-17	157-23-U200, KUP-14A15-240	Relay, plug-in, 3 PDT, 240 VAC
PR-21	157-23-F2LC, KUP14D35110	Relay, plug-in, 3 PDT, 110 VDC
PR-32	670-0125, A759	Relay Socket, 3 Pole, Screw Terminal Base, 15 Amp, front mounted 6-32 screw terminals accept wires up to 14 AWG.



HRP-45



MIS-204D



PR-72

Type "F" Magnet Switch Moving Contact Assembly

(This arrangement normally open contact assembly)

Item	S.E.E.S. #	O.E.M. #	Description
1	HRP-17	3-28763-01	Contact Bridge
2	HDO-13	3-28763-02	Contact Bridge
3	HRP-19	28764	Guide
4	HRP-20	19486	Insulator
5	HRP-21	22100	Spring
6	HRP-22	3-20696-01	Washer
7	HRP-23	3-17592-03	"T" Head Screw

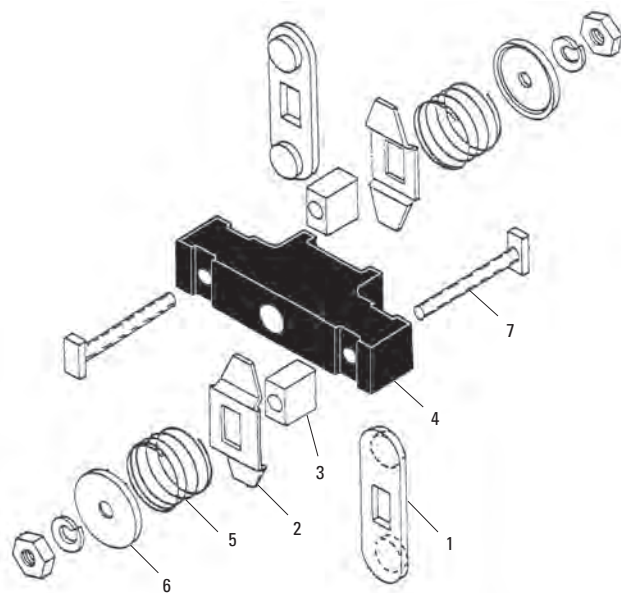

Relay Parts



HRP-13

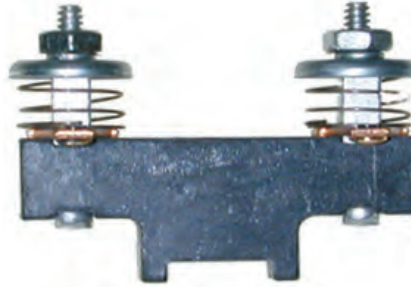

HRP-14



HDO-13



HRP-14B

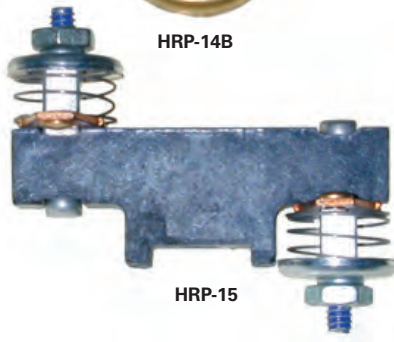

HRP-15



HRP-17



HRP-19



HRP-16

S.E.E.S. #	O.E.M. #	Description
HRP-13	10062	Contact assembly, 2 N.O., for type "F" magnet switch
HRP-14	3-10062-08	Contact assembly, 2 N.C., for type "F" magnet switch
HRP-14B	3-20696-02, 20696-B	Seat, washer, spring steel for HRP-14
HRP-15	3-10062-09	Contact assembly, 1 N.O., 1 N.C., for type "F" magnet switch
HDO-13	3-28763-02, 28763-E	Contact bridge, gold for HRP-14 and HRP-24
HDO-13A	3-40304-67	Contact bridge, silver

S.E.E.S. #	O.E.M. #	Description
HRP-16	3-10062-03	Contact assembly, 1 N.O., long block
HRP-17	3-28763-01	Contact bridge, heavy duty
HRP-19	28764	Contact bridge guide

Relay Parts



HRP-20

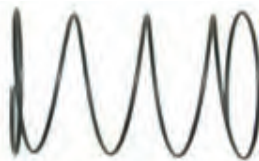

HRP-21



HRP-22



HRP-23

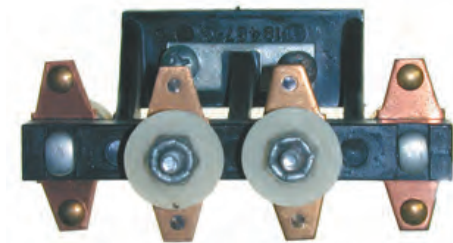

HRP-24

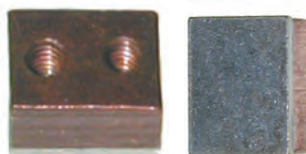

HRP-25



HRP-26

S.E.E.S. #	O.E.M. #	Description
HRP-20	19486	Insulator, Contact bridge, 1-7/8"
HRP-21	22100	Compression Spring for HRP-24 movable contact assembly, 1/2" O.D. x 3/4" long, 5-1/2 turns
HRP-22	3-20696-01, 20696-A	Spring seat washer for HRP-45 contact spring guide, used with HRP-21 spring
HRP-23	3-17592-03	Screw, "T" head, #6-32 x 1" used with HRP-21 and HRP-22
HRP-24	3-10062-13	Movable contact assembly, 2 N.O. and 2 N.C. contacts may be rearranged in the field to suit
HRP-25	3-20387-02, 20387-B	Stationary contact for "F" magnet switch and M.G., copper 1/2" x 3/8" x 5/16", with silver face
HRP-26	3-20397-00, 20397-B	Stationary contact, copper 3/4" x 1/2" x 3/8", with silver face
HRP-27	34-0725-005	Moving contact for Type "B", "B-1", and "B-2" Vernier and FA selector, type 300 stainless steel, 3/8" x 1-7/16"
HRP-28	3-20345-02	Moving contact for Type "B", "B-1", and 20345-B "B-2" Vernier and FA selector, type 300 stainless steel, contact surface 3/8" long
HRP-31	20324	Finger contact, 1/16" x 1/2" x 1-1/2" with oblong mounting hole 3/16" x 5/16" for car switch, manual door
HRP-5*	3-16562-08, 16562-M	Selector contact, 1-5/16" overall length
HRP-30*	3-20310-01, 30210-A	Selector contact, 1-13/16" overall length
HRP-30A*	3-40319-62	Selector contact, 2-1/2" overall length

*Button type selector contacts for type "B", "B-1", "B-2", and "FA" selectors and type "K" limit switch, 3/8" dia. head with 3/8" diameter silver contact.



HRP-27



HRP-28



HRP-31



HRP-5



HRP-30



HRP-30A

Relay Parts

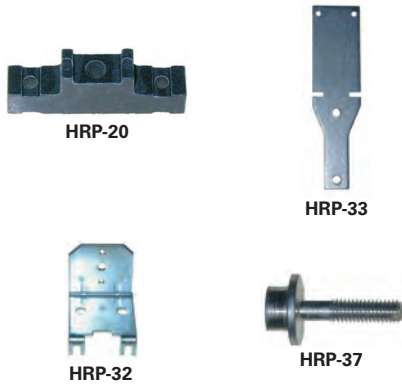

Type "BN" and "DN" Relays

S.E.E.S. #	O.E.M. #	Description
HRP-20	19486	Insulator , contact bridge insulator for 10062 series, movable "2" contact assemblies on AN, AM, AT, BN, and N relays
HRP-29		Base , Bakelite Relay/ Used On AN, AM, BN, DN Type Relays
HRP-32	3-28842-02, 28842-C	Core bracket for armature on AN and AM relays, used with HRP-33 and HRP-34
HRP-33	3-28841-02, 28841-C	Armature for AN, AM, and BN "6" contact relays
HRP-34	3-28841-01, 28841-B	Armature for AN, AM, and BN "4" contact relays
HRP-37	3-17592-02, 17592-C	Adjusting screw , 1-1/16" O.L., 10-32 thread for AN and AM relays

Contacts



Stationary Contacts for Relays "AN", "AM" and "BN"

S.E.E.S. #	O.E.M. #	Description
HRP-35	3-20456-01, 20456-A	Gold Contact , 29/32"
HRP-35A	3-40304-69	Silver Contact , 29/32"
HRP-35B	3-20456-02	Gold Contact , 51/64"
HRP-36	20456	Gold Contact , 63/64"
HRP-36A	3-40304-68	Silver Contact , 63/64"

S.E.E.S. #	O.E.M. #	Description
HRP-43	20386	M.G. start contact , movable with blowout copper, 1/2" wide with 3/8" x 1/2" silver contact
HRP-44	3-20386-02, 20386B	M.G. start contact , movable without blowout copper, 1/2" wide with 3/8" x 1/2" silver contact
HRP-39	17548	Contact , adjustable stationary contact stud for AT, F, & N relays, 13/16" overall with 5/16" dia. silver tip, used with HRP-14A contact bridge
HRP-40	3-17548-06, 17548-H	Contact , stationary, heavy duty stud 13/16" O.L., contact 5/16" dia. used with HRP-17 contact bridge
HRP-41	20429	Movable contact , Copper, 1" x 1" face, for "F" magnet switch
HRP-41A	3-23033-02	Shunt , Braided for HRP-41
HRP-41B	3-28918-02	Bracket , for HRP-41
HRP-42	21003	Carbon contact , stationary for HRP-41 movable contact
HRP-42A	20706	Relay Part , contact holder assembly for HRP-42
HRP-46	3-18266-2	Movable contact , assembly

HRP-41, HRP-41A and HRP-41B assembly

Relay Parts



HRP-50

■ Type "C" Relay 4-1/2" O.L.



HRP-54



HRP-56

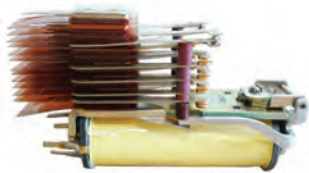

HRP-67



HRP-70



HRP-80

■ Type "J" Relay 2-1/4" O.L.



HRP-87

Telephone Type Relays

Relays S.E.E.S. #	O.E.M. #	Contacts Type	Contacts			Replacement Coils		Voltage	
			NO	NC	SPDT	S.E.E.S. #	O.E.M. #		
HRP-50	33-1097-001	C	4	2	2	HC-34B	34-1032-005	60	VDC
HRP-51	33-1097-004	C	3	2	0	HC-33	34-1032-006	120	VDC
HRP-52	33-1097-005	C	3	2	0	HC-40	34-1032-007	18	VAC
HRP-53	33-1097-006	C	3	2	0	HC-34	34-1032-003	120	VDC
HRP-54	33-1097-007	C	3	2	0	HC-34	34-1032-003	120	VDC
HRP-55	34-1097-008	C	2	1	1	HC-34C	34-1032-008	4	VDC
HRP-56	34-1097-009	C	2	1	1	HC-34	34-1032-003	120	VDC
HRP-57	34-1097-010	C	4	2	2	HC-34B	34-1032-005	60	VDC
HRP-58	34-1097-012	C	2	0	0	HC-42	34-1032-010	120	VDC
HRP-59	34-1097-013	C	3	2	0	HC-42	34-1032-010	120	VDC
HRP-60	34-1097-014	C	12	0	0	HC-34	34-1032-003	120	VDC
HRP-61	34-1097-015	C	0	0	8	HC-34	34-1032-003	120	VDC
HRP-62	34-1097-016	C	4	2	2	HC-42	34-1032-010	120	VDC
HRP-63	34-1097-017	C	2	1	1	HC-42	34-1032-010	120	VDC
HRP-65	34-1097-019	C	8	4	0	HC-34	34-1032-003	120	VDC
HRP-66	3-40155-37	C	4	0	2	HC-38	3-40155-15	120	VDC
HRP-67	3-40155-38	C	6	2	2	HC-38	3-40155-15	120	VDC
HRP-68	3-40155-40	C	6	0	4	HC-38	3-40155-15	120	VDC
HRP-69	3-40220-69	C	8	4	0	HC-35	3-40258-34	24	VDC
HRP-70	3-40258-28	C	6	2	2	HC-35	3-40258-34	24	VDC
HRP-71	3-40267-98	C	6	4	0	HC-35	3-40258-34	24	VDC
HRP-72	3-36353-01	C	0	0	6	HC-34	34-1032-003	120	VDC
HRP-80	34-1097-002	J	4	2	0	HC-41	34-1032-009	60	VDC
HRP-81	34-1097-003	J	2	2	0	HC-44	34-1032-012	120	VDC
HRP-83	34-1097-005	J	4	2	0	HC-44	34-1032-012	120	VDC
HRP-84	34-1097-006	J	4	2	0	HC-44	34-1032-012	120	VDC
HRP-85	34-1097-007	J	4	2	0	HC-43	34-1032-011	120	VDC

HRP-85A	42765-1	Terminals for telephone type relays
HRP-85B	35-1094-004	Arc Suppressor Assembly for telephone type relays
HRP-87		Photo SW, #CP18LDND2/ dark operate
HRP-88	3-40332-16	Contactors, 3 Pole 25A, 80 VDC Type MG5



HT-1



HT-4



HT-8

Timers

S.E.E.S. #	O.E.M. #	Description
HT-1	3-40224-09	Range 0.5 - 30.0 sec. "CJ-1" Model
HT-2	3-40224-10	Range 3 sec. - 5 min., "CJ-6" Model
HT-3	3-40152-78	Range 0.6 - 60 sec., 115 VDC
HT-4	3-40224-09	Range 0.5 - 30 sec., 24 VDC
HT-7	3-40269-81	Range 3 sec.- 8 min., 24 VDC
HT-8	3-36187-004	Vacuum tube #5693

Transformers



HTR-1



HTR-4

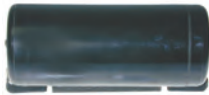

HCAP-1



HRES-1

S.E.E.S. #	O.E.M. #	Description
HTR-1	03-026137-013	Transformer , 1 KVA, Primary voltage 240/480, Secondary voltage 117/254
HTR-2	3-40008-71	Transformer for controller, 3 phase, 2.8KVA
HTR-3	3-40008-87	Transformer , 3 phase, Primary voltage 180, 23-26-29 sec.
HTR-4	3-40155-19	Transformer , 208/230 VAC Primary 24-98 sec. 150 VA
HCAP-1	3-40163-08	Capacitor , 250V, 270-324MFD for EVC-ELC Control Drawers
HRES-1	3-40049-83	Resistor , 1.6 ohm 400 watt, 8-1/2"

Printed Circuit Boards and Stepper Switch



MIS-100K

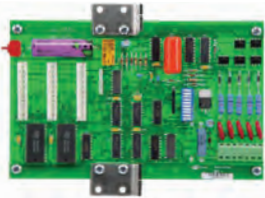

HRP-75A

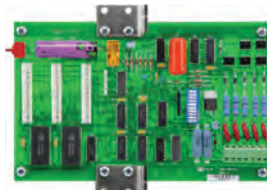

HRP-75B

Stepper Switch

S.E.E.S. #	O.E.M. #	Description
MIS-100K		Stepper Lube Kit , Assorted lubricants, specially formulated for maintaining stepping switch wear points. Prolongs life, improves performance
HRP-75A	HA-2544-L	Stepper Switch , 24 VDC, 16 position, electronic replacement
HRP-75B	HA-2544-M	Stepper , electronic, 110 VDC, 16 position
HRP-75AR	7403.901	Relay Board , stepper, for HRP-75A and HRP-75B

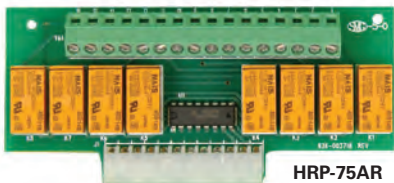

HRP-75AR



HDO-2D

Printed Circuit Boards

S.E.E.S. #	O.E.M. #	Description
HPC-1	3-40303-43	Switching Power Supply PC Board , 115 VAC primary, 5 VDC secondary @ 16 amps
HPC-2	3-40303-43	PCB , GMC Amplifier GMG Level
HPC-3	3-40337-61	Power Supply , +5V & 12V +24 VDC
HDO-2D	3-40007-82	Amplifier PC Board , for type "HE" safe ray
HPC-200	3-40337-61	PCB , Load Weigh Amp, Miconic V, LVL C
HPC-201	3-40337-61	PCB , Heatsink Board Assembly



HPC-1

Wheels and Rollers

HAUGHTON



S.E.E.S. #	O.E.M. #	Description
HW-1	35-2551-006	Interlock Roller and pin assembly, for type "M" Interlock, polyurethane roller 1-3/4" diameter x 3/4" wide face, 5/8" diameter pin extends 1-3/8" from roller
HW-1A	3-16497-00	Roller assembly , door clutch, 2-1/4" O.D. x 9/16" face with 7/16" bore
HW-15	35-727-30	Door Clutch Roller , 2-9/16" O.D. x 3/4" wide with 5/8" bearing I.D., for door clutch arm R.H. or L.H.
HDO-44	3-40136-44	Door Clutch Roller , and L.H. arm
HDO-45	3-40136-45	Door Clutch Roller , and R.H. arm
HW-2	3-16847-01	Door hanger Roller , nylon, 3-11/16" O.D. x 3/4" wide, .6299" bearing I.D.
HW-11	35-1229-03	Idler sheave for car door hangers and safety edge retraction unit, 1-7/8" O.D., 1/2" bearing I.D.
HW-14	AR928A3 12G1	Hanger Roller , 3-3/8" diameter, eccentric shaft, 5/8"-18 threaded, .220 shoulder
HW-14A		Hanger Roller , 3-3/8" O.D. with Special eccentric shaft, 5/8"-18 threaded, .130 shoulder
HW-14S		Shaft for HW-14 , Eccentric, 5/8" thread



Wheels and Rollers

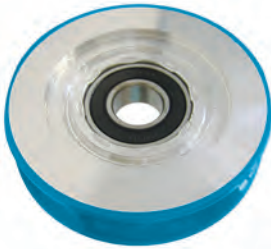

HW-6



HW-6A



HW-6B

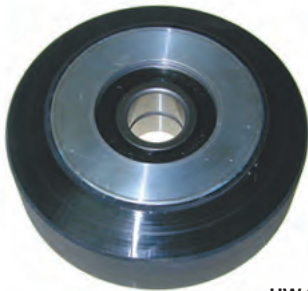

HW-3

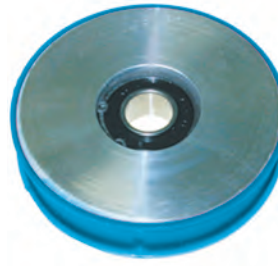
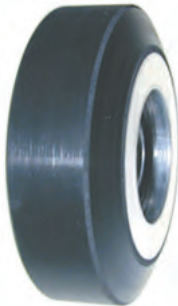

HW-7



HW-8



MIS-239



HW-3A



HW-9



HW-10



S.E.E.S. #	O.E.M. #	Description
HW-6	3-40130-77, 3-40130-79	Hanger roller, for B-4 hanger, 3-5/16" O.D. with .625" bearing I.D.
HW-6A	34-1004-001, 34-0792-097	Eccentric upthrust, 1" O.D. 7/16" W face
HW-6B	3-26064-00	Eccentric roller, 1-3/8" O.D., 1.343" O.L, 5/8" shaft
HW-6C		Upthrust, Eccentric 6203 Brg 5/8-18 Thread
HW-7	3-40157-63	Hanger roller, 3-11/16" diameter with .6299" bearing I.D.
HW-8	3-40157-60	Hanger roller, 2-5/8" diameter with .6299" bearing I.D.
HW-3	3-40150-71	Roller guide wheel, 3-1/2" O.D. x 1-5/16" W, with 3/4" W tire face, .6693" bearing I.D.
HW-3A	3-40196-75	Eccentric wheel support kit, includes eccentric pin, eccentric, washer, axle pin and hardware for roller guide wheel HW-3
MIS-239	J420 3-40151-00	Guide Roller, 3-1/2" O.D. x 1-5/16" W, with 3/4" wide tire face .6693" bearing I.D.
HW-9	3-40158-67	Roller guide wheel, 3-1/2" O.D. x 1-1/16" W, with 3/4" W tire face, .5119" bearing I.D.
HW-10	3-40134-75	Upthrust roller used on car door hangers for "TH" operator, 3-3/8" diameter with 3/4" W face, .6299" bearing I.D.

Wheels and Rollers



WW-20

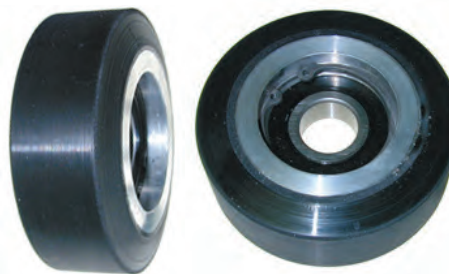

HW-4

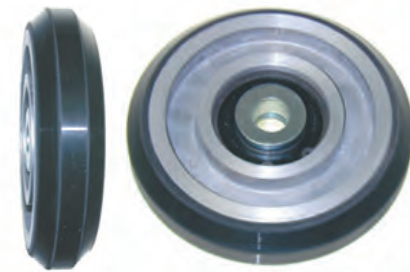

HW-5

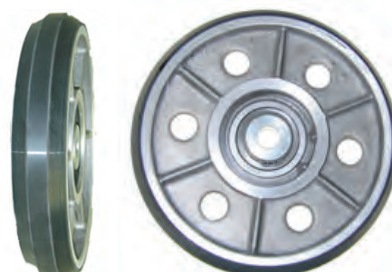

HW-12

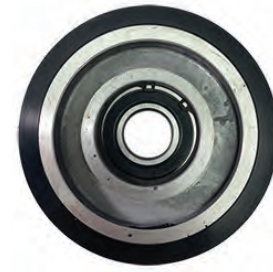

HW-5B



HW-12A



HW-12C

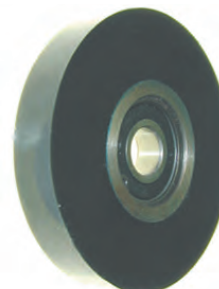

HW-16



HW-17

S.E.E.S. #	O.E.M. #	Description
WW-20	3-11143-05 35-1159-012	Roller Guide Wheel, 3" diameter, .6693" bearing I.D., 1" wide with 1/2" tire face
HW-4	3-40196-74	Roller guide wheel, 3-1/2" O.D. x 1-5/16" W, 1" tire face, with .7874" bearing I.D.
HW-5	35-1159-004	Roller guide wheel, 5" O.D. x 1-1/8" W, 7/16" W tire face, bearing has steel inner sleeve with .630" bearing I.D.
HW-5A	J-424	Roller guide wheel, 5" O.D. x 1-1/8" W, 7/16" Face 6205 Brg, .985" I.D., No Bushings, Face Roller
HW-5B		Roller guide wheel, 5" O.D. x 1-1/8" W-Face 6205 Brg, .985" I.D., Side Roller
HW-12	35-1159-002	Roller guide wheel, 8" O.D. x 1-3/8" W, 1/2" W tire face, .630" bearing I.D., bushing w/ 5/8" dia., Hardware part # HW-12C
HW-12A	3-40329-10	Roller guide, 8" x 1-1/4", .6204" bearing
HW-12AH	3-40329-1	Roller guide, 8" O.D. x 3/4" Face x .787" I.D., HD 90 Duro
HW-12B	3-40119-75	Roller guide, 10" O.D. x 1-5/16" W 3/4" Tire, Z995204 Brng
HW-12C		Hardware kit for HW-12A, bolt, retainer, spacer, washer, nut
HW-16	3-19373-02	Limit switch roller, 3-1/2"
HW-17	3-40010-13	Tach roller, 3-1/2" aluminum hub, 5/16" I.D.
HW-18	3-40155-59	Door Hanger & Roller, assembly, with 3-5/16" O.D x 3/4" W roller

Decimal and Metric Equivalents

Fractions	Decimals In.	Metric M.M.
1/64	.015625	.39688
3/64	.046875	1.19062
5/64	.078125	1.98437
7/64	.109375	2.77812
5/32	.140625	3.57187
3/16	.171875	4.36562
7/32	.203125	5.15937
1/4	.234375	5.95312
9/32	.265625	6.74687
5/16	.296875	7.54062
11/32	.328125	8.33437
3/8	.359375	9.12812
13/32	.390625	9.92187
7/16	.421875	10.71562
15/32	.453125	11.50937
1/2	.484375	12.30312

Fractions	Decimals In.	Metric M.M.
33/64	.515625	13.09687
17/32	.53125	13.49375
35/64	.546875	13.89062
9/16	.5625	14.28750
37/64	.578125	14.68437
19/32	.59375	15.08125
39/64	.609375	15.47812
5/8	.625	15.87500
41/64	.640625	16.27187
21/32	.65625	16.66875
43/64	.671875	17.06562
11/16	.6875	17.46250
45/64	.703125	17.85937
23/32	.71875	18.25625
47/64	.734375	18.65312
3/4	.750	19.05000
49/64	.765625	19.44687
25/32	.78125	19.84375
51/64	.796875	20.24062
13/16	.8125	20.63750
53/64	.828125	21.03437
27/32	.84375	21.43125
55/64	.859375	21.82812
7/8	.875	22.22500
57/64	.890625	22.62187
29/32	.90625	23.01875
59/64	.921875	23.41562
15/16	.9375	23.81250
64/64	.953125	24.20937
31/32	.96875	24.60625
63/64	.984375	25.00312
1	1.00	25.40000

Courtesy of ELEVATOR WORLD, INC., from Elevator Maintenance Manual. Copyright © 1999. Reprinted by permission.

HITACHI

QUICK LOCATOR GUIDE

Car Signal Components	670
Pushbutton Assemblies	670
Door Parts	670
Contacts	670
Door Locks	670
Door Slider	670
Door Vane	670
Encoder	671
Guide Shoe Assemblies	671
Inserts	671
Roller for Guide Shoe	671
Magnetic Sensor	672
Printed Circuit Boards	672
Switches	672
Limit Switches	672
Wheels and Rollers	671
Guide Shoe Rollers	671
Hanger Assemblies	671
Hanger Rollers	671
Wheel for Door Lock	671

Pushbuttons



HIBT-1



HIBT-2



HIBT-4



HIBT-1-ARROW-DOWN



HIBT-1-ARROW-UP



HIBT-9



HIBT-13

S.E.E.S.

Description

HIBT-1	Pushbutton, RL-1 (3 Lines)
HIBT-2	Pushbutton, RL-1 (4 Lines)
HIBT-4	Pushbutton, SL-TC, Specify Marking
HIBT-4-ARROW	Pushbutton, SL-TC, Marked Arrow
HIBT-7	Pushbutton, DL-PO2 for NPX
HIBT-8	Pushbutton, RL-MA with Light
HIBT-9	Pushbutton, AK2026
HIBT-10	Pushbutton, AL-POE
HIBT-11	Pushbutton, for RL-1
HIBT-12	Pushbutton, for SL-TC
HIBT-13	Pushbutton, EL-PO
HIBT-1-ARROW-DOWN	Pushbutton, RI-1 (3 Lines) Marked Arrow DOWN
HIBT-1-ARROW-UP	Pushbutton, RI-1 (3 Lines) Marked Arrow UP

Door Parts



HILO-2



HILO-5



HILO-8



HILO-15



HIDV-1

S.E.E.S.

Description

HILO-2	Landing Door Triangular Lock with Key
HILO-5	Door Lock HY-GR
HILO-6A	Side Door Lock, TKB-1A
HILO-6B	Side Door Lock, TKB-1B
HILO-8	Contact for Door Lock
HILO-9	Base Floor Lock
HILO-11	Door Lock, DK-RSL
HILO-12	Door Lock, DK-RN4
HILO-13	Door Lock for Goods Lift
HILO-14	HY07 Side Contact Switch
HILO-15	COP Lock
HIDV-1	Door Vane (SET)

Rollers

S.E.E.S. #	O.E.M. #	Description
HIW-3		Roller, Hanger, 130mm x 30m with 15mm I.D. Double 6202
HIHR-1		Roller, Hanger 65mm x 13mm, bearing 6202RS GD:60 ID:15mm
HIHR-3		Roller, Retainer for Hanger Assembly 33mm x 10mm 6g-M10
HIHR-6		Roller, Freight Lift Hanger 70mm x 20mm GD:64 6204 ID:20mm
HILO-3		Wheel, for Door Lock 45mm x 15mm ID:12mm
HIDH-1L		Hanger Assembly, Landing Door (SET)
HICOD-4	TS5208N122	Encoder, 100-1024C/T-C2-12V 78
HIDS-1		Door Slider
HIDV-2		Roller, Door Vane 45mm x 15mm ID:12mm



HIHR-1



HIHR-3



HIHR-6



HILO-3



HIDH-1L



HICOD-4

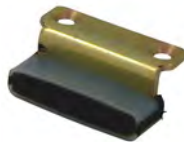

HIDS-1



HIDV-2

Guide Shoes

S.E.E.S. #	Description
HIGS-1	Guide Shoe Insert, Set of 3, 120mm x 22mm x 16mm
HIGS-2	Guide Shoe Insert, 124/120mm x 28mm x 10mm
HIGS-6	Guide Shoe, 16mm
HIGS-7	Guide Shoe, 10mm
HIGS-8	Guide Shoe, 16mm
HIGS-12	Guide Shoe, 125mm x 10/16mm
HIGS-13	Roller for Guide Shoe, 160mm x 30mm x 2mm, bearing 6004 ID:20mm
HIGS-14	Guide Shoe Insert, 65mm x 24mm x 17mm
HYGS-1	Guide Shoe, Hyundai, 120mm x 22mm x 6mm



HIGS-1



HIGS-2



HIGS-6



HIGS-7



HIGS-14



HIGS-13



HIGS-12



HIGS-8

Switches



HISW-13



HISW-14



HISW-1A



HISW-1B



HISW-3



HILO-14

S.E.E.S. #	O.E.M. #	Description
HISW-13		Limit Switch, LX22
HISW-14		Limit Switch, LX Hand-reset
HISW-1A	TKB-1A	Switch, Normally Open, Double Wheel, 110 VDC, 0.378A
HISW-1B	TKB-1A	Switch, Normally Closed, Double Wheel, 110 VDC, 0.378A
HISW-3		Limit Switch, 220V, 10amp
HILO-14		Switch, HY07 Side Contact

Printed Circuit Boards

S.E.E.S. #	Description
HIPCB-10	PCB, MTB-HLNF VMFG Well Serial Board, YSD-E00014-001-A, 32297963-2
HISS-2	Sensor, YG-3 Magnetic



HIPCB-10



HISS-2

KONE - MONTGOMERY

QUICK LOCATOR GUIDE

Belts	679
Brushes	680
Capacitors	693
Car Signal Components	674-678
Directional Plates	675
Hall Fixtures	675
Position Indicator	676
Pushbuttons	674-675
Stop Switches	676
Switches and Keys	676-678
Coils	679
Door Parts and Equipment	681-686
Clutch Assembly	684
Door Hanger Assemblies	683
Door Key	685
Door Operators	682
Door Operator Motors	686
Gib Assemblies, Gibs	685
Interlocks	681
Pick-up Assemblies	683
Pulley, Relating Cable	685
Sheaves	684
Spirator, Reel Closer	685
Transformer, Capacitor	686
Encoders	701
Hatch Equipment	688-689
Machine Parts	690
Printed Circuit Boards	691-693
Rectifiers	693
Relay Parts	696-699
Resistors	694-695
Rollers	704-707
Door Hanger Rollers	704
Guide Rollers, Guide Shoes	705-707
Roller Guide Wheel Assemblies	705-706
Safety Edge	703
Selector Parts	702
Tachometers, Tach Generators	701
Transformers	700
Valve Parts	700

Car Signal Components



MB-1-BLANK



MB-1A-ARROW



MB-1R



MB-1RA-ARROW



MB-2R



MB-2RA



MB-3RA

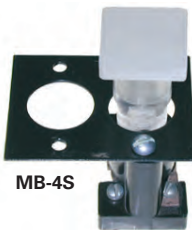

MB-4S



MB-4SA

■ MB-1R, MB-2R, MB-3R & MB-4S button styles furnished blank, engraving available



KB-200



KB-200A



KB-200B



KB-200C



KB-201A



KB-201B



KOBT-1-BLANK



KOBT-1-ARROW



KOBT-3-BLANK

Pushbuttons

S.E.E.S. #	O.E.M. #	Description
MB-1-	P16732 P8986	Pushbutton assembly , White button with black border, 1" sq. Specify marking, i.e. MB-1-BLANK
MB-1A-	P14426	Button and stem only , for MB-1. Specify marking, i.e. MB-1A-ARROW
MB-1R-	P5249	Pushbutton assembly , White button 7/8" diameter, specify marking, i.e. MB-1R-BLANK
MB-1RA-	P22207	Button and stem only , for MB-1R Specify marking, i.e. MB-1RA-ARROW
MB-2R	P2049A	Pushbutton assembly , black button, 7/8" dia.
MB-2RA	P22206	Button and stem , black, 7/8" diameter
MB-3R	P2050A	Pushbutton assembly , red button
MB-3R-ALARM		Pushbutton assembly , Round Red "Alarm", 7/8" O.D.
MB-3R-CLOSE		Pushbutton assy , Round Red "Close" 7/8" O.D.
MB-3RA	P15259A	Button and stem , red, 7/8" diameter
MB-4S	P6440	Pushbutton assembly , white button, 7/8" square, blank
MB-4SA-	P22208	Button and stem , square, white, 7/8" button only for MB-4S assembly
MB-4S-SPECIAL	P22208	Pushbutton assembly , 7/8", square, white button, indicate special marking
KB-200	63686-001	Arrow , for Lantern, LED, 24V, Red, replaces USP31928144
KB-200A	63686-002	Arrow , for Lantern, LED, 24V, Green, replaces USP31927144
KB-200B	P-31927-012	Arrow , for Lantern, Green
KB-200C	63658-001	PCB , for Button/Pilot, 24V
KB-201A	63659-001	Button Body , PB/Pilot, 220 Complete, 1-1/8" x 1-7/8"
KB-201B	63650-001	Plate Tactile , 220 Push Button
KB-201C	US63654001	Plate , Pressel, Flush, Arrow
KB-201D	US63656001	Plate , Pressel, Flush, Arrow
KB-1-STOP	P14426072	Pushbutton assembly , Red Button 1" square, marked "STOP"
KB-1A-STOP		Button only , Red 1" square, marked "STOP"
KOBT-1-BLANK	KM804345G090	Button , Milky, Car, Amber, Blank
KOBT-1-ARROW	KM804163G06	Button , Milky, LCS, Amber, End, Up
KOBT-3-BLANK	KM801057G090	Button , Gray, LCS, Amber, Blank
KPC-006	USP31550001	PCB , Hall Fix, 1 Yellow LED

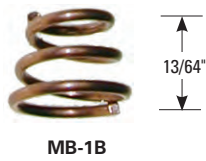

MB-1B

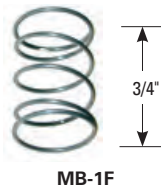

MB-1F



MB-1E



MB-1C



MB-1G

Pushbuttons

S.E.E.S. #	O.E.M. #	Description
MB-1B	2881-131	Conical spring , used on button assemblies
MB-1F	2881-157	Spring , used on stem for button assemblies
MB-1E	61602-002	Screw , used to hold movable contact disc to stem assembly
MB-1C	14595	Contact , stationary, N.O., 9/16" long
MB-1G	25666	Contact , stationary, N.C., 13/16" long
MB-1D	15257	Contact , disc, moveable, 3/4" diameter

S.E.E.S. #	O.E.M. #	Description
MBL-1	34221	Lamp socket , for screw base S6 lamp
ML-15	27799	Lamp , 10S6 10W 250 VAC screw base
ML-17	20741	Lamp , 6S6/155V 6W 155 VAC screw base
ML-18	17334	Lamp , 6S6/120V 6W 120 VAC screw base
ML-55	20920	Lamp , 40W 120V, lumiline
ML-84	20753	Lamp , 15W 120V, screw base



MB-1D



MBL-1

Hall Fixtures

S.E.E.S. #	O.E.M. #	Description
MB-2	P8987	Hall plate , stainless steel, 3-1/2" x 9" with 1" square hole in center for button, for terminal landings. Mounting holes 7" c/c
MB-2A	P8988	Hall plate , stainless steel, 3-1/2" x 9" with two 1" square holes for intermediate landings. Mounting holes 7" c/c



MB-3-HORIZONTAL



MB-3-VERTICAL



MB-2



MB-2A

Directional plate

S.E.E.S. #	O.E.M. #	Description
MB-3-HORIZONTAL	P9658	Horizontal directional plate , stainless steel, 4-1/4" x 9-1/2", mounting holes 7-5/8" c/c, for use on Intermediate Floors
MB-3-VERTICAL	P9962	Vertical directional plate , stainless steel, 4-1/4" x 9-1/2", for use on Intermediate Floors
MB-4	P9672	Directional arrow , green, 2-1/4" x 2-13/16"
MB-5	P9671	Directional arrow , red, 2-1/4" x 2-13/16"
MB-5A	P9670	Directional arrow , white, 2-1/4" x 2-13/16"



MB-5A



MB-4

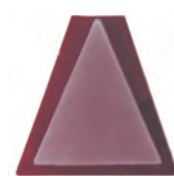

MB-5

Car Signal Components



MB-6-



MB-7



MB-7A



MB-7C



MB-7D



KKS-200



MB-7F-ACCESS-J217



MB-7F-LOCKOUT



MKS-1

MKS-2

MKS-3

MKS-14

Position Indicator

S.E.E.S. # O.E.M. # Description

MB-6- P14437 **Position Indicator**, white, 1" square position indicator head with black border, specify marking, i.e. MB-6-ARROW

Switches

S.E.E.S. # O.E.M. # Description

MB-7	P25744, 50620	Stop Switch , toggle style, 3 PDT
MB-7A	19251	Stop Switch , toggle style, 3 PST
MB-7C		Key Switch assembly , RUN/STOP to replace toggle style stop switches MB-7, MB-7A, with #A-03 key
MB-7C-SPECIAL		Key Switch , Specify Marking and Cylinder
MB-7D		Key Switch assembly , same as above but with round bezel, RUN/STOP
MB-7F-FLOOR		Key Switch , 2Pos, Rmv2, Off-On-Floor, Black, Round, #3 Key
MB-7F-SPECIAL		Key Switch , 2Pos, Rmv2 Off-On-Floor Black, Round, #3 Key
MB-7F-ACCESS-J217-KN		Key Switch , 3Pos, momentary, black, round, Kraus & Naimer, J217 Key
MB-7F-ACCESS-J217		Key Switch , 3Pos, momentary, black, round, J217 Key
MB-7F-LOCKOUT		Key Switch , 2Pos, Momentary, Remove in "Off" Black, Round, Off-On Lockout, SEES#3 Key
MB-7G-SPECIAL		Bezel , Red Round Mont, Engraved
KKS-200	94826-002	Keyswitch , with cable assembly, NY
KHE-200	P-31921-002	Sensor , Bistable, with pins
KHE-201	KM829341G03	Switch , 61 U/N, 30, Cigar, 3M
KOSS-2A		Switch , Magnetic Reed, Mono-Stable, 250V, 100W
KOSS-3	KM713227G01	Switch , Magnetic Reed, Bistable, 110V max
KOSS-7	KM86420G03	Switch , Oscillator
MKS-1	US63862001	Key Switch , Fire Service PHI, 3 position key switch with #MK-05 key
MKS-2	US63863001	Key Switch , Fire Service PHII, 3 position key switch with #MK-05 key
MKS-3	US63860001	Key Switch , fire service phase II, > 2000 yr. 3 position key switch with #MK-05 key
MKS-14	P25020	Key Switch , Kone key switch 2 position spring return with #A-00 key

■ Bezels also available in black.

Keys

S.E.E.S. #	O.E.M. #	Description
MK-1	48350-004	Key, A-40, Master Key
MK-2	48350-000	Key, A-00
MK-3	48350-001	Key, A-01
MK-4	48350-002	Key, A-02
MK-5	50007903	Key, fire service, for old style Corbin lock
MK-6		Key, A03 Key for MIS-189C Fire Service Switch
MK-7	MK-02/MK2	Key, MK-02 key for medical car and hall panels
MK-8	EX-515	Key, Montgomery, fire service (Innovation #EX-515)
MK-9	EX-513	Key, Innovation general purpose barrel key #EX-513
MK-10	EX-512	Key, Innovation, #EX-512
MK-11	US63851005	Key, Kone fire service key #MK-05
MK-12	US63851003	Key, Kone swing return panel key #MK-03
MK-13	EX-516	Key, Security lock out #EX-516
MK-14	US63851006	Key, Service, #MK-06 key



MK-1



MK-2



MK-3



MK-4



MK-5



MK-6



MK-7



MK-8



MK-9



MK-10



MK-11



MK-12



MK-13



MK-14

Car Signal Components

Keys



MK-15



MK-17



MK-18



MK-24



KK-204



MB-9



MK-19



MK-20



MK-22



MK-23



KK-200



KK-201



KK-202

S.E.E.S. #	O.E.M. #	Description
MK-15	US63851-001	Key , Stop Switch Key #MK-01
MK-17	US63851-004	Key , Inspection Switch Key #MK-04
MK-18	US63851-009	Key , Security Key #MK-09
MK-19	US519417	Key , Access Key Switch Key, EX-515
MK-20	EX-511	Key , Barrel EX-511
MK-21	EX520	Key , EX520
MK-22	L200	Key , Elongated Triangle, L200
MK-23	EX-517	Key , EX-517
MK-24	EX-518	Key , EX-518
MK-25	A-04	Key , A-04 KEY
KK-200	KM825062H02	Key , Service, Tubular Key, KONE #2 Key
KK-201	KM825062H01	Key , Service, Tubular Key, KONE #1 Key
KK-202	KM825062H03	Key , Service, Tubular Key, KONE #3 Key
KK-204	KM825062H04	Key , Service, Tubular Key, KONE #4 Key
KK-205	KM825062H05	Key , Service, Tubular Key, KONE #5 Key

S.E.E.S. #	O.E.M. #	Description
MB-9	65230	Lens , 2-7/16" square, for Vector button
MB-10	P22339, P24368	Pushbutton switch assembly , Vector style
MB-10A	P24394	Micro switch for Vector button assembly

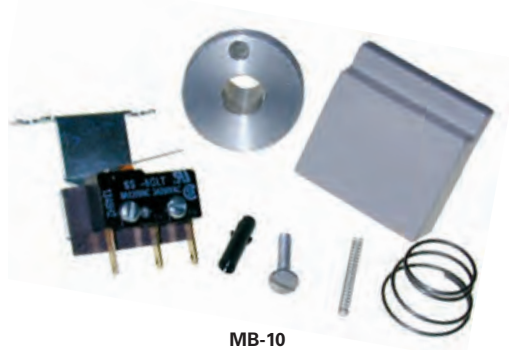

MB-10



MB-10A

Coils

Contactors Coils

S.E.E.S. #	O.E.M. #	Resistance in Ohms	I.D.	O.D.	Length	Voltage
MC-1	11265A	1580	1-3/8"	3- 21/32"	1-5/8"	230 VDC
MC-2	15660	2200	1-3/16"	2- 9/16"	2-13/16"	230 VDC
MC-3	15963	1680	1-7/16"	2- 31/32"	2- 3/4"	230 VDC
MC-4	16272	420	1-3/16"	2- 51/64"	2-13/16"	115 VDC
MC-8	10971-00A	300	5/8"	2"	1"	220 VDC



MC-1, MC-2, MC-3, MC-4, MC-8

Brake Coils

S.E.E.S. #	O.E.M. #	Resistance in Ohms	I.D.	O.D.	Length	Voltage
MC-5	18992, 17040	386	1-25/32"	4- 3/8"	4"	230 VDC
MC-5A	17660	460	2-11/16"	6"	7-1/4"	230 VDC
MC-10	11525-00A	125	3/16"	3-3/8"	3"	115 VDC



MC-5, MC-5A

Valve Coils

S.E.E.S. #	O.E.M. #	Description
MC-6	28951	Valve coil, green, 110 VAC
MC-7	30074	Valve coil, red, 220 VAC



MC-7



MC-10

Gong Coils

S.E.E.S. #	O.E.M. #	Description
MC-9	43697	Gong coil, 120 VAC, 12amp Series



MC-9

Belts

S.E.E.S. #	O.E.M. #	Description
MDO-1	19501-21 5207D42H46	Belt, single belt, 55" x 1/2", #2550, belt 4L550, used with EZ/QKS-14/15 door operator
MDO-2	19501-22	Belt, Door operator, single belt, two required, 68" x 1/2", #2680, belt 4L680
MDO-2A	20267	Belt, Heavy duty timing belt, 1/2" pitch, 60" L x 1-1/2" W, 120 teeth
KBLT-001	916015	Belt, Timing/Toothed for Kone 5mm pitch
KBLT-002	916015	Belt, Timing/Toothed for Kone 5mm pitch 25mm wide 3900mm long
KBLT-003	916015	Belt, Timing/Toothed for Kone 5mm pitch 25mm wide 5450mm long
KBLT-004	916015060	Belt, Timing/Toothed for Kone 5mm pitch 12mm wide 2050mm long
KBLT-005	916015070	Belt, Timing/Toothed for Kone 5mm pitch 12mm wide 3510mm long
KBLT-006	916015080	Belt, Timing/Toothed for Kone 5mm pitch 12mm wide 4400mm long



MDO-1



MDO-2



MDO-2A



Brushes

S.E.E.S. #	O.E.M. #	Description
MCB-1	514991	Split brush, 5/8" x 1-1/4" x 2"
MCB-2	98579-005	Brush, 1/2" x 1-1/4" x 2"
MCB-9	47348-004	Brush, 3/8" x 1-1/2" x 1-3/4"
MCB-3		Split brush, 3/8" x 1" x 1-1/4"
MCB-4	45137-004	Split brush, 3/8" x 1-1/4" x 2"
MCB-5		Split brush, 3/8" x 1" x 2"
MCB-6		Split brush, 1/2" x 1" x 2-1/8"
MBH-1	500178	Brush holder for brush 5/16" thick x 1" W

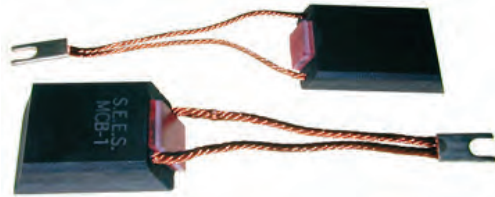

MCB-1



MCB-2



MCB-4



MCB-3



MCB-5, MCB-6



MCB-7



MCB-8

Door Motor Brushes

S.E.E.S. #	O.E.M. #	Description
MCB-7	58742	Brush for 49743 Dumore door motor, 3/8" W x 3/4" L
MCB-8	47743	Brush assembly
MCB-10	U5101874	Brush for S.E.E.S A.O. Smith motor MDO-29, 1/4" x 3/8" x 7/16"
MCB-10A		Brush replacement, for SEES Imperial motor MDO-29A
MCB-10B	90-637815-272-301	Brush, .63" x .787" x 1.5", Grade H51C
MCB-11		Brush for S.E.E.S motor MDO-29C



MCB-10



MCB-10A



MCB-11



MBH-1

Door Parts and Equipment

Interlocks

Fig.	S.E.E.S. #	O.E.M. #	Description
1	MDO-61	MAP144	Interlock assembly R.H./L.H.
2	MDO-10	P22106	Hook , Steel interlock hook
3	MDO-10A	MA778	Stud , Hook pivot
3A	MDO-10B	US58702	Hook Locking , with bushing
3B	MDO-10C	US58658	Clutch Hook , with bushing
4	MDO-3	MA1364	Contact , Stationary, two required
5	MDO-4	MAP142	Contact bridge , movable contact
6	MDO-4A	MAP146	Bridging contact , complete assembly
7	MDO-6	MA1204	Lift rod , 5/16" dia. x 44" L
	MDO-6R-RH	US58976	Lift rod , 5/16" dia. x 43" L for right hand with offset
8	MDO-6B	P22158	Unlocking arm , flag

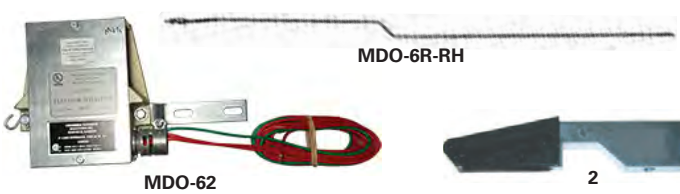
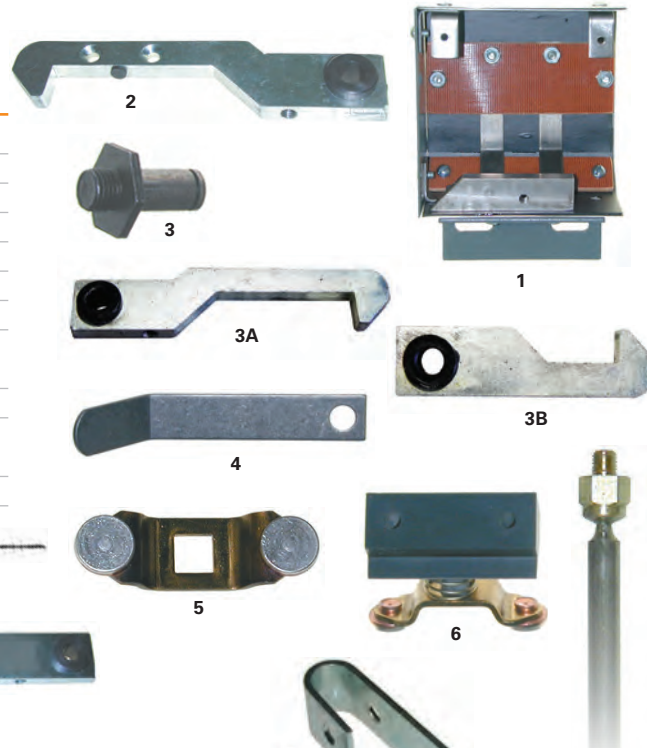

Interlocks

Fig.	S.E.E.S. #	O.E.M. #	Description
	MDO-62	P13002-002	Interlock , complete assembly, L.H.
	MDO-62A		Interlock Casting , For MDO-62 R.H./L.H.
	MDO-62C	P13002-COVER	Cover , for Interlock box, Fits L.H. and R.H.
1	MDO-62R	P13002-001	Interlock , complete assembly, R.H.
	MDO-62R-KIT-001	P13002-001 KIT	Interlock Assy , R.H. w/ Hook Assy
	MDO-62-KIT-001	P13002-002 KIT	Interlock Assy , L.H. w/ Hook Assy
	MDO-62-KIT-002	USP2223002	Interlock Assy , L.H. w/ Hook Assy, Rod, and Pick-Up Assy
	MDO-62R-KIT-002	USP2223001	Interlock Assy , R.H. w/ Hook Assy, Rod, and Pick-Up Assy
2	MDO-60	US40593	Hook and shorting bar assembly
	MDO-60B	USP31376001	Hook Interlock , L=5.625", R.H. bracket with shorting bar
	MDO-60C	USP31376002	Hook Interlock , L=5.625", L.H. bracket with shorting bar
	MDO-60D	US101661	Pivot Bracket Only , for Interlock 1/4" x 7/8" x 6.5"
3	MDO-10A	MA778	Stud , Hook pivot
4	MDO-11	US40594	Contact , leaf with 3/8" silver contact
5	MDO-11A	US40590	Base , Contact block, bakelite, 2 required
	MDO-11B	US40590	Interlock contact base assy , 2 Insulators with 2 Contact Blades
	MDO-11S	US40594	Contact , 40594 for Interlock 13002, solid silver contact
	MDO-17T-LH	22097-002 22077-021	Hook Bracket Assembly , L.H. Short and Calif.
	MDO-17T-RH	22097-001 22077-001	Hook Bracket Assembly , R.H. Short and Calif.
6	MDO-6	MA1204	Lift rod , 5/16" dia. x 44" L
7	MDO-60A	MA1661	Pivot bracket with stud for hook for MDO-60
	MDO-64	US41894	Contact leaf , with contact

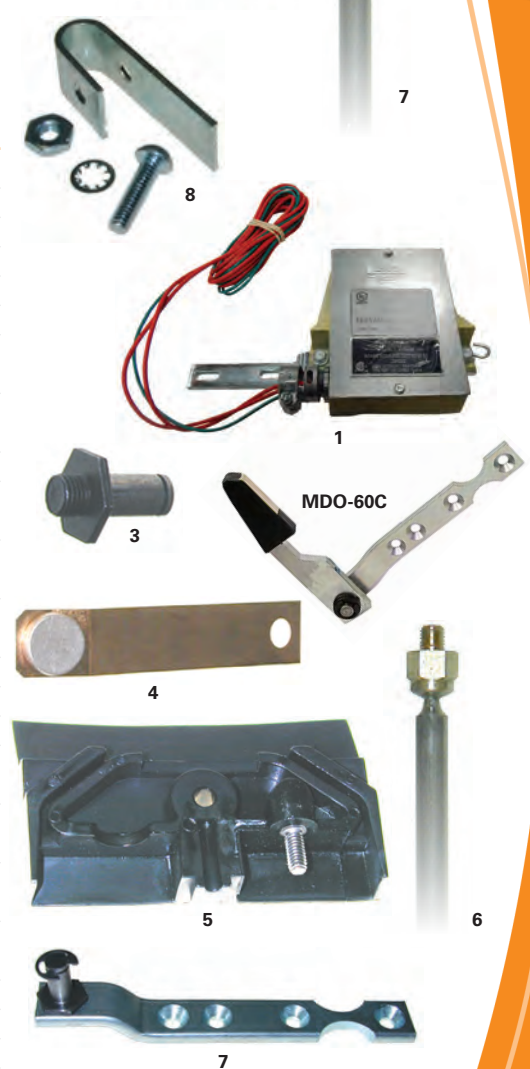

Door Parts and Equipment



USPC31947-001



USPC31947-002



USPC35011-001



USPC35011-002



MDO-50



MDO-50A



MDO-201

S.E.E.S. #	O.E.M. #	Description
USPC31947-001	USPC31947001	Door Operator , HP closed loop R.H.
USPC31947-002	USPC31947002	Door Operator , HP closed loop L.H.
USPC31947-001-OPER		Door Operator , HP CLSD Loop R.H. with Drive Arm, No Split Linkage
USPC31947-002-OPER		Door Operator , HP CLSD Loop L.H. with Drive Arm, No Split Linkage
USPC35011-001	USP35011001	Door Operator , MAC PMSSC, Standard, R.H. with board 104, replaces USP22266001
USPC35011-002	USP35011002	Door Operator , PMSSC, Standard, L.H. with board 104, replaces USP22261002
USPC35011-001-OPER		Door Operator , PMSSC R.H. with Drive Arm, No Split Linkage
USPC35011-002-OPER		Door Operator , PMSSC L.H. with Drive Arm, No Split Linkage
MDO-39	P24186	Cover for Door Operator
MDO-50	USP4411	Split Linkage Assembly , for PMSC & MSSC Door operator
MDO-50A	US25082001	Arm , PMSSC Door Link Arm without XDIM
MDO-50B	US25082002	Arm , PMSSC Door Link Arm X=2-25/32, for 42
MDO-50C	US25082003	Arm , PMSSC Door Link Arm X=4-3/4", for 36, S
MDO-50D	US25082004	Arm , PMSSC Door Link Arm X=5-1/2", for 42, S
MDO-50E	US25082005	Arm , PMSSC Door Link Arm X=6-1/4", for 48, S
MDO-51L	USP35026001	Lever , Long, Door Oper., 10 & 40" L.H. Standard Sill
MDO-51R	USP35026002	Lever , Long, Door Oper., 10 & 40" R.H. Standard Sill
MDO-52L	USP35027002	Lever , Long, Door Oper., L.H., 1-3/4, Shallow Sill
MDO-52R	USP35026001	Lever , Long, Door Oper., R.H., 1-3/4, Shallow Sill
MDO-53L	USP35028002	Lever , Long, Door Oper., 12 & 48" R.H. Standard Sill
MDO-53R	USP35028001	Lever , Long, Door Oper., 12 & 48" R.H. Standard Sill
MDO-201	12936-00A	Bolt , for Door Operator L 3/8"-24, Thread, 1" Long

Door Parts and Equipment



Fig.	S.E.E.S. #	O.E.M. #	Description
1	MW-9	P31316, MAP316	Pick-up assembly, R.H./L.H. interchangeable
2	MW-9A	P31216, MAP419	Lever, pivot assembly
3	MDO-5	101142, MA1142	Roller, 2" Door pickup roller
4	MDO-5B	MA1141	Stud, for pickup roller
	MDO-5C	MA1141-Slotted	Stud, for pickup roller, "Slotted" Head
5	MDO-5E	MA1149	E-Clip, 1/2"
6	MDO-15B	MA1155	Clevis, assembly
6A	MDO-15C	101156	Clevis Pin with ring groove and retaining ring
6B	MDO-200	P-30954-001	Adapter Plate, for Pick Up assembly
6C	MDO-201	KM50022228	Bolt, for Door Operator L 3/8"-24 Thread, 1" Long

Fig.	S.E.E.S. #	O.E.M. #	Description
1	MDO-15	MAP418	Pick-up assembly, R.H./L.H. interchangeable
	MDO-15-LH	USP31418-002	Pick-up assembly, L.H.
2	MDO-15A	P31419, MA1742	Pivot assembly for pickup assembly
3	MDO-5	MA1142	Roller, 2" dia., 1/2" I.D. Door pickup roller
	MDO-5A	MA10615	Roller, 2" dia., uses 1/4" shoulder bolt
	MDO-5-P	MA1142	Roller, as above but polyurethane
4	MDO-5B	MA1141	Stud for pickup roller
5	MDO-5E	MA1149	E-Clip, 1/2"
6	MDO-15B	MA1155	Clevis, Assembly
	MDO-15D		Spring, for MDO-15

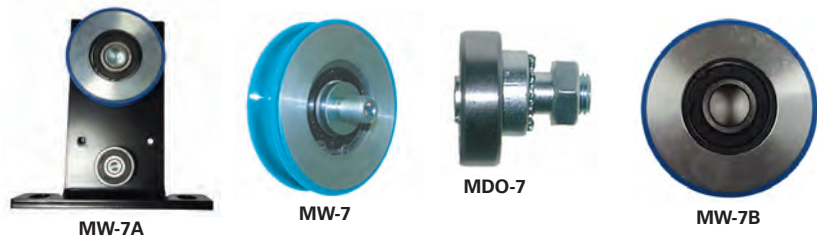

Door Hanger Assemblies

S.E.E.S. #	O.E.M. #	Description
MW-7A	MAP373, USP31373	Hanger, Hatch door hanger assembly
MW-7B	MAP-270, USP313400A	Hatch Door Roller, 2-7/8" O.D. .6693" bore w/o shaft
MW-7C		Shaft, For MW-7 and MW-8 Hatch Rollers
MW-7	MAP341, USP31341	Roller, Hatch door roller, 2-7/8"
MDO-7	MAP131, USP31131	Upthrust roller with eccentric pin
MDO-7A	USP22368	Upthrust roller for Shallow Door Clutch
MDO-19	MAP132, USP31132	Bolt pendant
MW-8	MAP344, P31344	Roller, Car door roller, 3-11/16"
MW-8A	MAP374, P31374	Hanger, Car door hanger assembly
MW-8B	MAP374 Less Shaft	Car Door Hanger Roller, 3-11/16" No Shaft
MW-8E	P22237	Roller, as above with eccentric
MW-8-HDW		Hardware, for MW-7 and MW-8 rollers, Bag of 4

Door Parts and Equipment



MDO-17



MDO-17B



MDO-17D



MDO-17E



MDO-17F

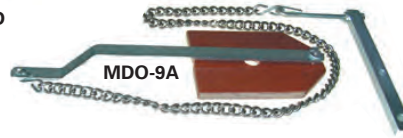

MDO-9A

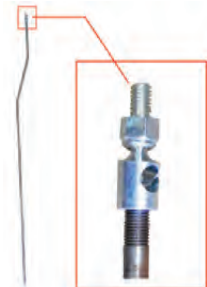

MDO-17T



MDO-17R-RH



MDO-17S-RH



MDO-9E

MDO-9H



MDO-30



MDO-32



MDO-31



MDO-34



MDO-34A



MDO-35



MDO-36

MDO-37



MDO-63

MDO-17T-EXT

S.E.E.S. #	O.E.M. #	Description
MDO-17	P22232	Clutch assembly
MDO-17A	MA1021, US101021	Cam , Retracting clutch, short cam
MDO-17B	MA1260	Spring , Conical spring for clutch
MDO-17C	US2881156	Spring , Compression for clutch
MDO-17D	US17046	Bushing , Bronze .376" I.D., .50" L for Door Clutch and break
MDO-17E	US101146	Bumper , Rubber 9/16" O.D.
MDO-17F	US58947/US58653	Hook Keeper , L=4.75, 1-3/4"
MDO-17G	USP22088	Pivot Arm , Clutch
MDO-17R-RH	USP31437001, 31436001	Lock Clutch , Restrictive, Standard/California, R.H.
MDO-17R-LH	USP22227002	Lock Clutch , Standard/California, L.H.
MDO-17R-SH-RH	USP22284001	Clutch , Restrictive, R.H. .625 Shallow for 1-3/4" Sill
MDO-17R-SH-LH	USP22284002	Clutch , Restrictive, L.H. .625 Shallow for 1-3/4" Sill
MDO-17R-SH-RH-A	USP22076001	Clutch , Restrictive, R.H. S/S, C/O 2S, .625 Shallow, 1-3/4" Sill
MDO-17S-RH	USP31435001	Bracket Clutch Hook , 5.96" R.H.
MDO-17S-LH	USP31435002	Bracket Clutch Hook , 5.96" L.H.
MDO-17T	US58656	Lift Rod , 44" for Clutch
MDO-17T-EXT	US58656EXTENDED	Lift Rod , 55" for Clutch
MDO-17T-LH	USP22097002	Hook Bracket Assy , L.H. Short and California
MDO-17T-RH	USP22097001	Hook Bracket Assy , R.H. Short and California
MDO-17U		Swivel Joint for MDO-17T
MDO-17V	US58651	Sensing Cam , Locking, Clutch Car Door
MDO-9	MA1152	Arm and chain , retracting door clutch
MDO-9A	MAP289	Linkage assembly , complete
MDO-9B	MA1134, P22120	Cam , alone, bakelite
MDO-9C	51906	Track , wide lip, 1-1/4" x 1-3/8" (replaces US35104)
MDO-9D	62010-004	Isolation pad , poly, 3/4" x 4" x 3"
MDO-9E	68726-003	Screw , 12mm L
MDO-9F	68785-005	Hex Nut , dri-lock
MDO-9G	P-31552	Service Tool MIPROM SL , Montgomery/Kone diagnostic
MDO-9H	US101154	Screw , Adjust 10-24 x 3.5" L "J" Hook for Chain
MDO-30	19502-029	Sheave , single 15-1/4" diameter
MDO-31	19502-028	Sheave , double 15-1/4" diameter
MDO-32	19502-031	Sheave , single 1.7" pitch for 1/2" shaft
MDO-33	19502-030	Sheave , double 1.7" pitch for 3/4" shaft
MDO-34	25076, US58819	Shaft , Reduction 3/4" O.D. x 12-1/2" L
MDO-34A	US-58819	Shaft , first reduction 3/4" O.D. x 13-7/8" L
MDO-35	25077	Shaft , Cam 1" diameter
MDO-36	19500-032	Pillow block , 3/4" diameter bore
MDO-37	38351	Pillow block , 1" diameter bore
MDO-63	101730	Bearing Assy , Flange for Door Operator with set screws

Door Parts and Equipment

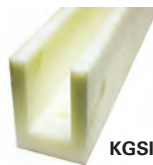

KGSI-001



KODS-1



KODS-2



KDO-001



KDO-200



KDO-201



KDO-202



KDO-203



KDO-203A



KDO-204



KSB-200



KDO-205



KSB-201



KON-001



MIS-119-P



MDO-38



MIS-119



MDO-23



MDO-23B



MIS-124



MIS-124-ST



MIS-750

S.E.E.S. #	O.E.M. #	Description
KGSI-001	DEE3685009, US32502	Guide Shoe Insert, #22 Rail, Nylon gib, 9.75" L
KGSI-002	DEE3685009, US25529	Guide Shoe Insert, #30 Rail, Nylon gib, 9.75" L
KODS-1		Door Gib, 71mm x 15mm x 12mm
KODS-2		Door Gib, Selcom, PAC2
KDO-001	DEE3685009	Block, ECO 3000 newel ends
KDO-200	75223	Retainer, Fire Tab Z Bracket, Bottom, At Sill
KDO-201		Retainer, Fire Tab Z Bracket, 3/4" Offset
KDO-202	KM835699G01	Gib assembly, for AMD
KDO-203	77590-022	Contact, for Door, AZ06, AMD RUS77590100, US518209, KM237487
KDO-203A	254995	Contact, for Door, Schmersal
KDO-204	280876	Switch, Magnetic, Replaces US5
KDO-205	KM274095	Switch, Door Contact, 230 VAC 2A
KDO-206		Clip, UL Fire Door, 1.25"
KON-001	KM5070729H01	Gib assembly, for AMD
KSB-200	62322-001	Isolation Bushing, for Shackle
KSB-201	48682	Isolation Bushing, for Shackle
KSB-202	US61632001	Isolation Bushing, for Shackle 7/8" I.D.
MDO-38	101871	"U" Bolt, 3/8"
MIS-119		Key, emergency door key, flapper style with collar
MIS-119-P		Door Key, Flapper with Plastic Handle and flexible safety shaft
MDO-23	MAP32	Pulley, relating cable, 3-1/8" O.D.
MDO-23A	MAP34	Pulley, relating cable, 2-3/4" O.D.
MDO-23B	P-22425-001	Cable End, stud assembly
MIS-124	P-22425-001	Spirator, reel type door closer, 5" dia. with universal mounting, square or two hole
MIS-124-ST		Spirator, 6" SmarTork door closer, up to 20% more tension
MIS-124-20PAC		Spirator, 5" with Combo hub, Pack of 20
MIS-124E		Spirator, 5" O.D., Heavy Duty reel closer with combo hub
MIS-124E-20PAC		Spirator, 5" O.D., Heavy Duty, economic pack of 20
MIS-750		Isolation Bushing, 6" x 4" x 1/2"



Door Parts and Equipment



MDO-18



MDO-18A

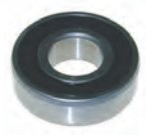

MDO-22



MDO-22A

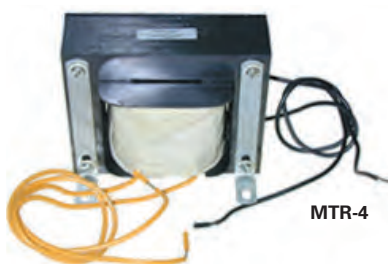

MTR-4



MTR-6

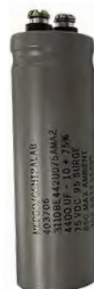

MCAP-2



MDO-21



MSE-1B



MDO-29

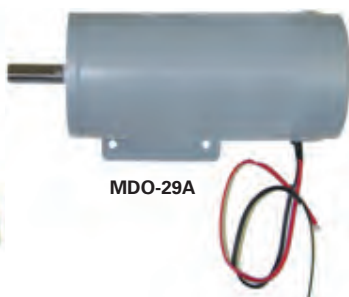

MDO-29A



MDO-29C



KDO-002



KOMT-1



KOMT-2



KOMT-3

S.E.E.S. #	O.E.M. #	Description
MDO-18	20058	Thrust washer, 2-1/4" O.D., 1-3/4" I.D.
MDO-18A	32441	Shoulder bolt
MDO-22	16604	Bearing for door operator
MDO-22A	101627, MA1637	Needle bearing for door operator

MTR-4	A46208	Transformer, PRI 120 VAC, Sec 32 VAC
MTR-6	US94615001	Transformer, 120/24V, 75VA, CL 2 Service
MCAP-2	46218	Capacitor, 4500 MFD, 40 VDC #46218 (4400 MFD / 75 VDC)

MDO-21	25078	Actuating Cam for door operator
MSE-1B	MA165	Micro Switch for safety edge

Door Operator Motors

S.E.E.S. #	O.E.M. #	Description
MDO-29	MA1555, MA1604	Motor, type NC O-55, 6 wire lead, 1/6 H.P., 1140 RPM, 230 VDC, 5/8" shaft diameter, Compound Wound
MDO-29A	49743, US101849	Motor, 1/6 H.P., 1140 RPM, 24 VDC, 3-1/4" dia. 8-1/2" L, uses MCB-10A brush
MDO-29C	19144	Motor, dampening, 1/3 H.P., 3450 RPM
KDO-002	COMMD006	Motor, 1/6 HP, 24 VDC, 1220 RPM, 1/2" shaft
KDO-002A	COMMD006	Motor, 1/6 HP, 1220 RPM 1/2" Shaft with Encoder Shaft
KOMT-1	KM89717G08	Door Motor, geared door D1 40 VDC 1.65A
KOMT-2	KM89717G06	Door Motor, geared door D1
KOMT-3	KM89717G04	Door Motor, geared door D1 40 VDC 1.65A
MCB-10	U5101874	Brush for SEES A.O. Smith motor MDO-29, 1/4" x 3/8" x 7/16"
MCB-10A		Brush replacement, for SEES Imperial motor MDO-29A
MCB-11		Brush for S.E.E.S motor MDO-29C

KNOW ENFORCER^{EDGE} KNOW SAFETY

PATENT # SEES 8,181,394

Enforcer^{EDGE}

REPLACES ALL OF THESE GIB KITS

Part Number	Gib width
SEES-ENFORCER-EDGE-R	7/16"
SEES-ENFORCER-EDGE-G	15/32"
SEES-ENFORCER-EDGE-W	1/2"
SEES-ENFORCER-EDGE-B	17/32"

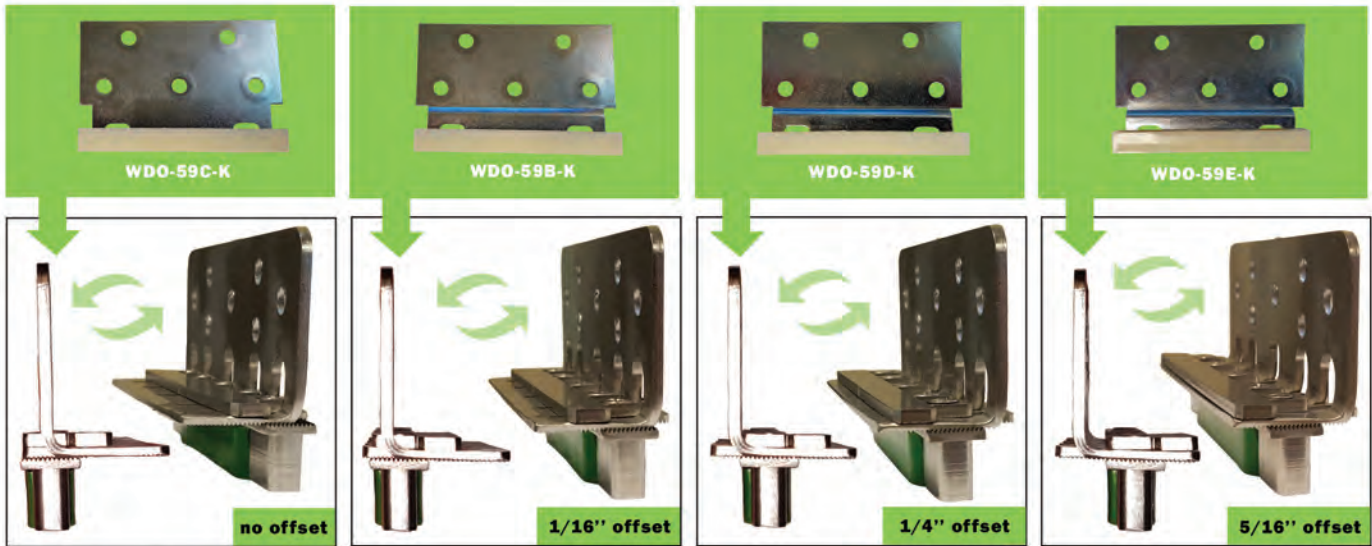
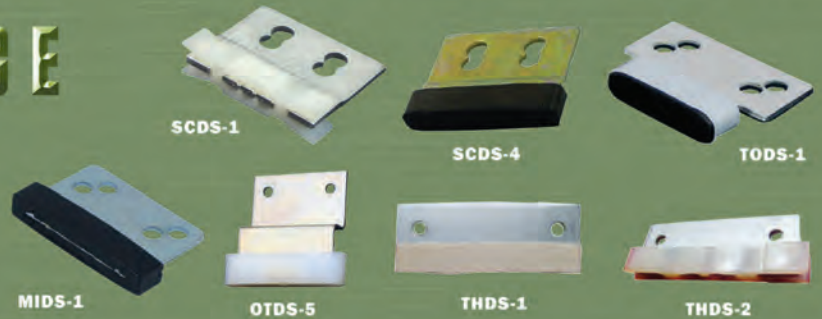

NO OFFSET? NO PROBLEM: SEES Enforcer Edge is perfect for Westinghouse elevators with offsets between 0 and 5/16ths.



Always Smooth Sailing





Hatch & Hoistway Equipment



KHE-200

S.E.E.S. #	O.E.M. #	Description
KHE-200	P-31921-002	Sensor, Bistable, with pins
KHE-201	KM829341G03	Switch, 61 U/N, 30, Cigar, 3M
KOSS-2A		Switch, Magnetic Reed, Mono-Stable, 110V, 100W
KOSS-3	KM713227G01	Switch, Magnetic Reed, Bistable, 110V max
KOSS-7	KM86420G03	Switch, Oscillator



KHE-201



KOSS-2A



KOSS-3



KOSS-7



MHE-1

S.E.E.S. #	O.E.M. #	Description
MHE-1	P33235-001	Limit switch assembly, N.C., wires out of back
MHE-2	P33217-005	Limit switch assembly, N.C., wires out of side
MHE-2A	US91167001	Limit Switch, SPDT, 1 N.O. 1 N.C.
MHE-AA		Roller & Arm, Replacement For MHE Series switches above
MRP-13	8159	Contact disc, movable, for limit and gate switches, 1" diameter
MRP-13A	P4231	Contact assembly, movable, base with MRP-13 contact
MRP-14	8162	Contact, stationary contact for gate and limit switch
MRP-14A	P4232	Contact assembly, stationary, base with MRP-14 contact
MDO-5A	10615	Roller, 2" diameter retractable roller

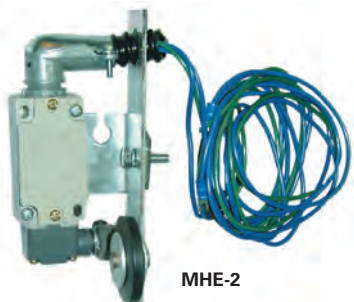

MHE-2



MHE-2A



MHE-AA



MRP-13



MRP-13A



MRP-14



MRP-14A



MDO-5A

Hatch & Hoistway Equipment

S.E.E.S. #	O.E.M. #	Description
MHE-1A	P1046A	Gate switch
MHE-1B	45556	Contact assembly, movable for MHE-1A
MDO-11	40594	Contact, leaf with 3/8" silver contact
MDO-11A	A40590	Base, Contact block, bakelite, 2 needed
MDO-24	P31029	Actuator, gate switch
<hr/>		
MHE-3	P12926	Magnetic leveling switch assembly
MHE-7	P13347	Magnetic floor switch assembly
MHE-7A	42984	Magnet use with MHE-7 switch
MHE-8	61404	Photo Switch
<hr/>		
MHE-9	US95362001	Switch, Mag-Reed, Bi-stable
MHE-9A	US95363001	Switch, Mag-Reed, Mono Stable Barrel Type Without Terminals
MHE-9B	KM829341G04	Switch, Reed Leveling N.O. 100 VAC 3 Meter Lead & Cable
MHE-10	USP135400C	Limit switch, with roller
<hr/>		
MIS-181C	US50085300C	Magnetic leveling switch, double DPDT unit 2569AD US508951
MIS-181D		Magnetic switch, for Vertisys operator
MIS-197B	USP18576	Emergency Ceiling Exit, Switch Assy, Car Top Escape
MRP-19A	P16577	Magnetic switch, leveling unit, low power (Miprom)
MRP-19B	P16578	Magnetic floor switch, low power

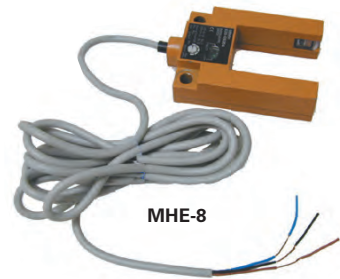
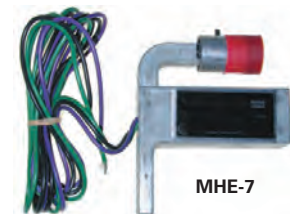
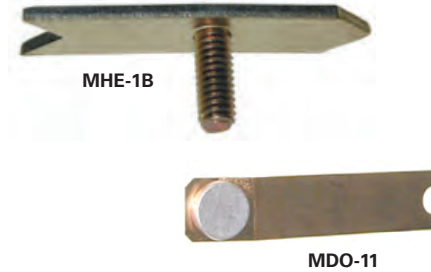



Machine Parts



Machine Seals and Bearings

207E MACHINE WORM SHAFT

S.E.E.S. #	O.E.M. #	Description
MMP-1		Thrust bearing kit
	46333-001	Bearing angular
	47286-002	Lock nut
	47287-002	Washer
MMP-2	46332-001	Worm shaft bearing
MPAC-3	9096-017	Oil seal worm shaft 1.9375"

208E AND 210 MACHINE WORM SHAFT

MPAC-1	9096-021	Oil seal (motor end 1.125" shaft)
MPAC-3	9096-017	Worm shaft seal
MMP-2	46332-001	Worm shaft bearing
MMP-4		Thrust bearing kit
	46333-002	Bearing angular
	47286-002	Lock nut
	47287-002	Washer

207E MACHINE SHEAVE SHAFT

MMP-3	46311-006	Roller bearing cup and cone
	46312-006	
MPAC-10	9096-047	Oil seal sheave shaft for 207E Machine 2.625" x 3.548"

208E MACHINE SHEAVE SHAFT

MPAC-17	9096-016	Sheave seal, 3.5" shaft
MMP-5	46312-004	Roller bearing cone
	46311-004	Roller bearing cup
MMP-5A	US-18147	Shim and Gasket, for Mach thrust bearing cap
MPAC-20	US41543	Seal, rubber with spring for gear box
MMP-6	46312-007	Roller bearing cone and cup
	46311-007	
MPAC-15	9096-024	Sheave seal, 4" shaft



Thrust Bearings

S.E.E.S. #	O.E.M. #	Description
MMP-7	46333-003	Thrust bearing, DUP 5.5



Drum Shaft Bearing Assemblies

S.E.E.S. #	O.E.M. #	Description
MMP-10	46312-005	Cone
	46311-005	Cup
MMP-11	46312-008	Cone
	46311-008	Cup

Bearing Kits for Imperial MG Sets

S.E.E.S. #	K.W.	Frame	Description
MMP-13	3	254A, 250	Bearing same both ends
	5	284AY, 280TY, D26, R284	
	7-1/2	284AY, 280TY, D26, R284	
	10	286AY, 280T	
MMP-14	15	324AY, 320TY	Bearing same both ends
	20	326AY, 320TY	
MMP-15	25	366AY, 360TY	Bearing same both ends
	30	367AY, 360TY	
	40	367AY, 360TY	
MMP-16	50	D59, 405T	Bearing motor end
	60	D59, 405T	
MMP-17	50	D59, 405T	Bearing generator end
	60	D59, 405T	
MMP-18	10	D35, R324	Bearing motor end
	15	D37, P324	
	20	D45, R326	
MMP-19	10	D35, R324	Bearing generator end
	15	D37, P324	
MMP-20	20	D45, R326	Bearing generator end
	25	D45, R364	
	30	D47, R365	
MMP-21	25	D45, R364	Bearing same both ends
	30	D47, R365	
MMP-22		2881-1266	Brake Spring



Seals

S.E.E.S. #	O.E.M. #	Size	S.E.E.S. #	O.E.M. #	Size
MPAC-1	9096-021	1.125	MPAC-17A	Split	3.5 x 5.0
MPAC-19	9096-001	1.375	MPAC-17	9096-016	3.5
MPAC-2	9096-002	1.562	MPAC-11	9096-027	3.938
MPAC-3	9096-017	1.938	MPAC-15	9096-024	4.00
MPAC-4	9096-004	2.00	MPAC-12	9096-029	4.375
MPAC-5	9096-020	2.188	MPAC-18	9096-015	4.5 x 6.256
MPAC-6	9096-023	2.25	MPAC-14	9096-046	4.5 x 5.756
MPAC-7	9096-018	2.375	MPAC-13	9096-025	6.5 x 8.007
MPAC-8	9096-005	2.437			
MPAC-9	9096-028	2.5			
MPAC-10	9096-047	2.625	MPAC-14		



Printed Circuit Boards

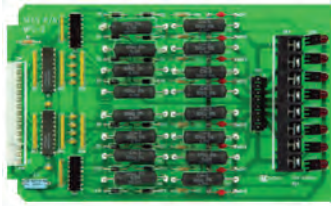

MPC-2

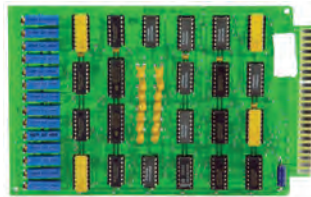

MPC-3

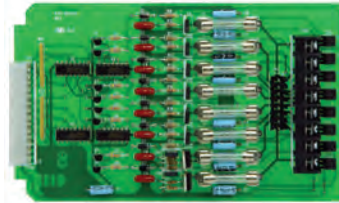

MPC-4

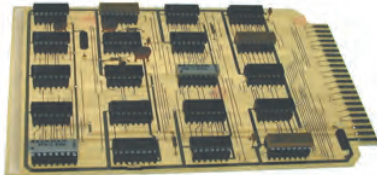

MPC-7

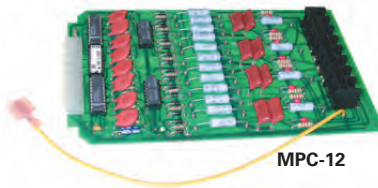

MPC-12

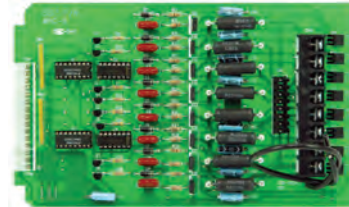

MPC-9

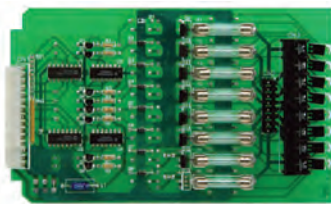

MPC-6

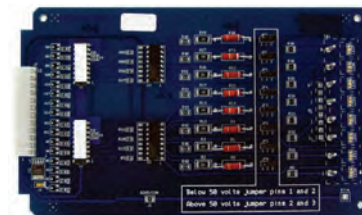

MPC-13A



MPC-14

S.E.E.S. #	O.E.M. #	Description
KPC-201	KM769900G13	Drive, V3F16L, Monospace, CSA, Coated PCB's (20 AMP)
KPC-201-CORE		KPC-201 Core
KOPCB-24	KM774150G01	PCB, V3F16L Kone
MPC-2	P15761	Input Board, Miprom, input with terminal
MPC-2A	USP29630001	PCB, Miprom Input Snub
MPC-3	P16780	Timer, Board 14X (Replaces 9X)
MPC-4	P15775, P16776	Output Board, Miprom, AC output with terminal
MPC-6	P15778, P16778	Output Board, Miprom, DC output with terminal
MPC-7	P16783	Input/Output Board, Miprom, in/out interface
MPC-8	P16835, P16787	Power Board, Miprom, power with brown out
MPC-9	P24147, B49886	Output Board, output with terminals
MPC-12	P24151	Miprom Input, 11 Snubber printed circuit board w/ leads
MPC-13A	USP29629002	Miprom board, AC/DC 24-110V
MPC-14	P24865	"LON" gateway control board
MPC-15	P24323	M2 relay pilot
MPC-16	P-24869003	DOT Matrix PI, DIG, #3 with Eprom, service
MPC-17	USP24100	Miprom Hydro, Relay Out with Molex
MPC-18	US49860036	Cable, Miprom Relay Out, Com
MPC-20	USP15903	PC Board, Conn II Miprom
MPC-25	65738	PCB, Power Supply, Series A
MPC-36	P-15839	Cardrack, MIPROM CPU-I/O (replaces USP15838)

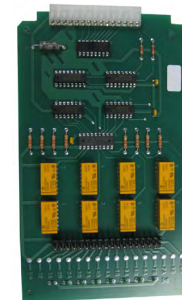

MPC-17

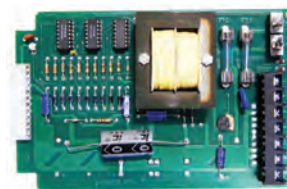

MPC-20



MPC-25



MPC-36

Printed Circuit Boards

MDO-12

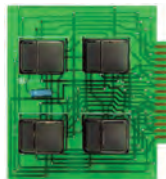
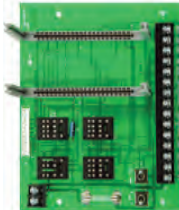
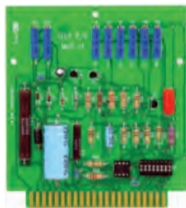
F-362005

MDO-13

MDO-13A

MDO-14

MDO-14A

MDO-41

MPC-27

MPC-38

MDO-42A

MDO-40

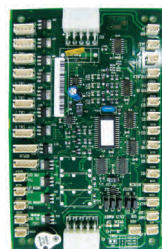
MPC-60

KPC-004

S.E.E.S. #	O.E.M. #	Description
MDO-12	A46223, B47135 B49711, P15765, P16364, P24172, P24173	Power board
F-362005	47310	Fuse, 1/2 Amp, 125V, for MDO-12 1/4" Diameter x 1" Long
MDO-13	A46221, P16362	Relay board
MDO-13A	B46224, B47136 P15766, P16365	Common board
MDO-13C	P24264	Monitor board
MDO-14	P24561 P16363, P24170, P24171, B47134, B49710, A46222, P15675, P15764	Speed board, solid state
MDO-14A	P24150	Door Operator Board, with relays
MDO-40	P24783-001	Door Operator Board, PMSSC
MDO-40A		Wiring Harness, for MDO-40 (104 PCB)
MDO-41		Switch Assembly, with Cable, door operator
PR-12A	M-2505	Relay, 4 PDT, 120 VAC, 5 AMP, with LED
PR-96A	47170, 9453048	Relay, 120 VAC, 2PDT, 10 AMP
MDO-42A	KM50022228	Door Operator Board, 109 5LCD Replaces USP31872003
MPC-23	61791	Field pulse
MPC-24	65737	PSI, DDC Series A
MPC-25	65738	Power Supply, Series A
MPC-26	95740-002	DDC, main, Rev 1 HDWE
MPC-27	P-24301	M2, Parallel I/O
MPC-28	P-24571	MEGA, ETS, slowdown
MPC-30	P-35620-004	Speed sensor, universal digital
MPC-32	61793	Armature Pulse
MPC-33	90722	DDC DRV, Power Series B
MPC-34	90723-002	DDC DRV, PSI/Switch B (replaces US90723)
MPC-35	95781-002	DDC DRV, Motion ADPT
MPC-36	P-15839	Cardrack, MIPROM CPU-I/O (replaces USP15838)
MPC-37	P-24107	Final assembly, 4EA (replaces US49805)
MPC-38	P-24325	M2, relay interface, F
MPC-38A	USP30387	PCB, M2, MSU, Interface
MPC-39	P-24377	M2, CPU, W/O SERL, F
MPC-40	P-24530	I/O, 24V, DC, mega
MPC-41	P-24531	Mega, DC, AB
MPC-42	P-24532	Firing, DC Mega replaces US61794
MPC-43	P-31729-005	Door Operator, PH2
MPC-44	P-31787-001	Escalator Relay Board, 1 brake, 1 Speed replaces P31787002
MPC-45	P-31787-003	Escalator Relay Board, 2 Brake, 2 Speed, 8"
MPC-46	P-31807-002	M2, CPU2, 256K memory (replaces USP2487)
MPC-47	P-31888-002	Hydro level shifter
MPC-48	P-32302-004S	Escalator MCU S Control FNL E5000
MPC-49	P-31895-002	Power supply, DC, with PLT & CBLs (replaces USP31895001)
MPC-51	USP31891002	PC Board, Car Panel, Connect Front
MPC-60	USP31894001	Power Supply, MRPM 24 VDC 3 Amp +/- 12 VDC 1 AMP, 5 VDC 10 AMP
KPC-001	KM935697G01	ADON2 G01 kit, 240 volts - (replaces KM773360G01)
KPC-003	802890G11	Car connect
KPC-004	757650G11	COP Board, LCECOB24 (replaces KM757650G01)
KPC-007	KM476203G01	PCB, CPU BOARD
KPC-008	KM371850G01	Regulator Board Assembly

Printed Circuit Boards

S.E.E.S. #	O.E.M. #	Description
KPC-005	USP31887001	COP Board , Machine Room Connection
KPC-006	USP31550001	PCB , Hall Fix, 1 Yellow LED
KPC-200	KM838770G01	PCB assembly , LCEADON2, 240 VAC
KOPCB-35	KM713130G01	PCB , LCEKNX Konexion
MAPC-710		PCB , Control board, Schumacher



KPC-005

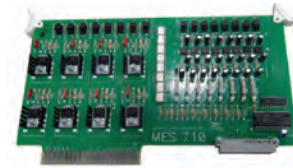

MAPC-710

Capacitors

S.E.E.S. #	O.E.M. #	Description
MCAP-1	26643	Capacitor , 189-227 MFD, 330 VNP, Non Polar
MCAP-2	46218	Capacitor , 4500 MFD 40 VDC #46218 (4400 MFD / 75VDC)
MCAP-4	25265	Capacitor , 1 MFD, 630 VDC
MCAP-5	20858	Capacitor , .05 MFD, 1600 VDC
MCAP-6	44519	Capacitor , 60 MFD, 350 VDC
MCAP-7	26444	Capacitor , 330 VAC



MCAP-2



MCAP-6



MCAP-1



MCAP-7

Rectifiers

S.E.E.S. #	O.E.M. #	Description
MRET-1	P4905	Rectifier , 3 phase bridge, 60 plates, 260V, 3.3 amp
MRET-2	P16359	Rectifier , 3 phase solid state
MRET-3	61799	Rectifier , SC, Dual, 90A-1200V

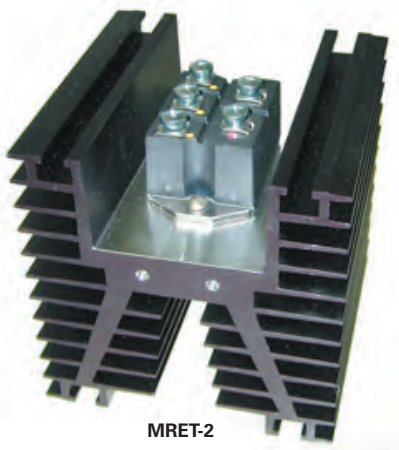

MRET-2

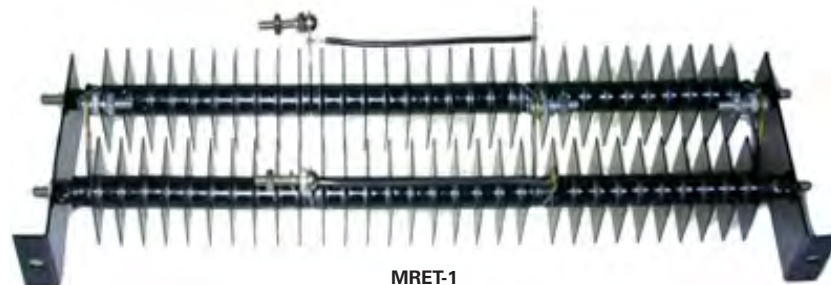

MRET-1

Resistors

130 Watt Fixed Resistors

8-1/4" C/C STUD MOUNTING

S.E.E.S. #	O.E.M. #	Description
MRES-41	P2883-2	1.5 Ohms
MRES-42	P2883-3	2 Ohms
MRES-43	P2883-4	3 Ohms
MRES-44	P2883-5	4 Ohms
MRES-45	P2883-6	5 Ohms
MRES-46	P2883-7	7.5 Ohms
MRES-47	P2883-8	10 Ohms
MRES-48	P2883-9	15 Ohms
MRES-49	P2883-10	20 Ohms
MRES-51	P2883-12	30 Ohms
MRES-52	P2883-13	40 Ohms
MRES-53	P2883-14	45 Ohms
MRES-54	P2883-15	50 Ohms
MRES-55	P2883-16	60 Ohms
MRES-56	P2883-17	75 Ohms
MRES-57	P2883-18	80 Ohms
MRES-58	P2883-19	100 Ohms
MRES-59	P2883-20	125 Ohms
MRES-60	P2883-21	150 Ohms
MRES-61	P2883-22	175 Ohms

S.E.E.S. #	O.E.M. #	Description
MRES-62	P2883-23	200 Ohms
MRES-63	P2883-24	250 Ohms
MRES-64	P2883-25	300 Ohms
MRES-65	P2883-26	400 Ohms
MRES-66	P2883-27	450 Ohms
MRES-67	P2883-28	500 Ohms
MRES-68	P2883-29	600 Ohms
MRES-69	P2883-30	700 Ohms
MRES-70	P2883-31	750 Ohms
MRES-71	P2883-32	800 Ohms
MRES-72	P2883-33	900 Ohms
MRES-73	P2883-34	1 K Ohms
MRES-74	P2883-35	1.2 K Ohms
MRES-75	P2883-36	1.4 K Ohms
MRES-76	P2883-37	1.5 K Ohms
MRES-77	P2883-38	1.6 K Ohms
MRES-78	P2883-39	1.8 K Ohms
MRES-79	P2883-40	2 K Ohms
MRES-80	P2883-41	3 K Ohms
MRES-81	P2883-42	4 K Ohms
MRES-82	P2883-43	5 K Ohms

25 Watt Adjustable Resistor

S.E.E.S. #	O.E.M. #	Description
RES-1	29784	5 Ohms
RES-2	29785	10 Ohms
RES-9	32398	1 K Ohms
RES-10	25270	1.5 K Ohms
RES-11	19911	2 K Ohms
RES-12	25270	3 K Ohms
RES-13	32399	5 K Ohms

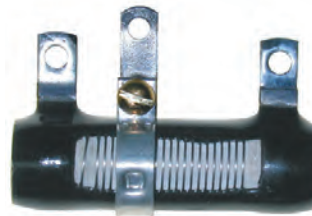

RES-1

25 Watt Fixed Resistor

S.E.E.S. #	O.E.M. #	Description
RES-81		5000 Ohms
RES-81A	9719015	25W 7500-MX



RES-69

20 Watt Fixed Resistor with Leads

S.E.E.S. #	O.E.M. #	Description
RES-69	20362	150 Ohms
RES-70	20361	250 Ohms
RES-71	20360	500 Ohms
RES-76	31697	7.5 K Ohms

Resistors

200 Watt Adjustable Resistors

S.E.E.S. #	O.E.M. #	Description
RES-55	19510	200 W, 50 Ohms
RES-56	19315	200 W, 100 Ohms
RES-59	19511	200 W, 250 Ohms
RES-61	23200	200 W, 1 K Ohms

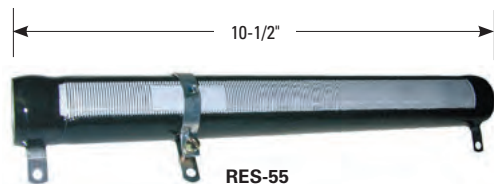

200 Watt Adjustable Resistors with Metal Ends

S.E.E.S. #	O.E.M. #	Description
MRES-11	23165	200 W, 10 Ohms, with metal ends
MRES-12	24477	200 W, 20 Ohms, with metal ends
MRES-13	24478	200 W, 30 Ohms, with metal ends
MRES-14	23166	200 W, 50 Ohms, with metal ends
MRES-15	23167	200 W, 100 Ohms, with metal ends
MRES-16	23168	200 W, 250 Ohms, with metal ends
MRES-17	23169	200 W, 500 Ohms, with metal ends
MRES-18	23170	200 W, 1 K Ohms, with metal ends
MRES-19	23171	200 W, 2.5 K Ohms, with metal ends
MRES-19A	23173	200 W, 5 K Ohms, with metal ends

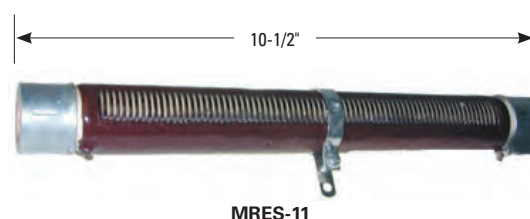

350 Watt Adjustable Resistors with Metal Ends

S.E.E.S. #	O.E.M. #	Description
MRES-20	37976	350 W, 5 Ohms, with metal ends
MRES-21	37977	350 W, 10 Ohms, with metal ends
MRES-22	37978	350 W, 15 Ohms, with metal ends
MRES-23	37979	350 W, 20 Ohms, with metal ends
MRES-24	37980	350 W, 30 Ohms, with metal ends

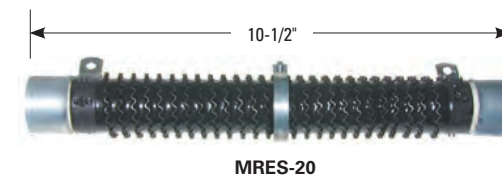

750 Watt Adjustable Resistors

S.E.E.S. #	O.E.M. #	Description
MRES-28	44555	750 W, 3 Ohms
MRES-30	30105	750 W, 5 Ohms
MRES-31	26697	750 W, 10 Ohms
MRES-32	26696	750 W, 15 Ohms

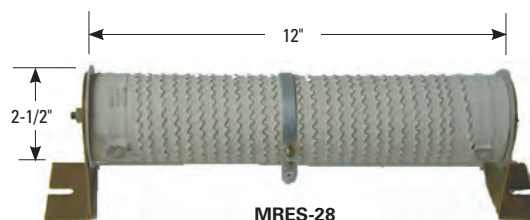

S.E.E.S. #	O.E.M. #	Description
MRES-09	US91081002	2 K Watt 36 Ohms, 20" Core Rib
MRES-33	KM260645	375 Watt 33 Ohms, Fixed Core Rib

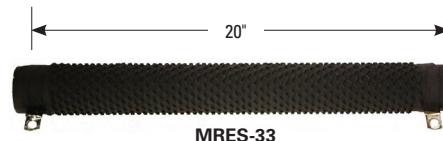
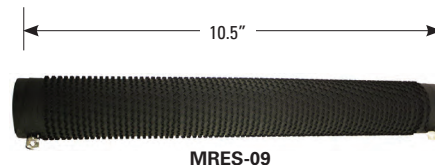



Relay Parts



MRP-17



MRP-17B



MRP-17C



MRP-17D



MRP-17F



MRP-17G



MRP-17H



MRP-17I



MRP-17J



MRP-17K



MRP-17M



MRP-17Q

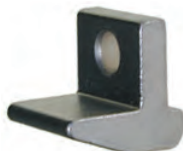

MRP-18

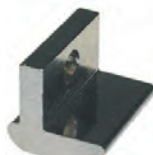

MRP-18B



MRP-17T



MRP-23



MRP-24



MRP-25



MRP-28



MRP-27

S.E.E.S. #	O.E.M. #	Description
MRP-17	10400	Contact , movable, 5/8" W x 2-3/8" L, for 75 Amp (Note: Makes with MRP-18)
MRP-17A	21339	Contact , same as MRP-17 but with silver pad (Note: Makes with MRP-18A)
MRP-17B	14203	Contact , movable contact finger, 7/8" W x 2-3/8" L, for 125 Amp (Note: Makes with MRP-18B)
MRP-17C	10403	Anchor , compression spring retainer
MRP-17D	2881-125	Spring , compression
MRP-17F	10401	Support , contact finger 75 Amp
MRP-17G	10402	Clamp for support 75 Amp
MRP-17H	10401-A	Support for contact finger 125 Amp
MRP-17I	10402-A	Clamp for support 125 Amp
MRP-17J	10440	Holder for contact
MRP-17K	10461, P25143	Shunt , braided
MRP-17L	16422	Mounting for contact
MRP-17M	16909	Magnet blowout
MRP-17Q	10996	Mounting for contact
MRP-18	10460	Contact , stationary contact for P, U, D and SB, 3/4" W, for 75 Amp (Note: Makes with MRP-17)
MRP-18A	21340	Contact , same as MRP-18 but with silver pad (Note: Makes with MRP-17A)
MRP-18B	14205	Contact , stationary contact, 1-1/16" W for 125 Amp (Note: Makes with MRP-17B)

S.E.E.S. #	O.E.M. #	Description
MRP-17T	10515	Arm , mounting for arc chute
MRP-23	15685	Armature stop on D.C. contactors
MRP-24	16788	Silencer cork used on D.C. contactor
MRP-25	16787	Silencer spring
MRP-27	10430	Stand-off bearing , 75 Amp contactor
MRP-28	2881-136	Spring for 75 Amp contactor

Relay Parts

Stem and Contact Assemblies

S.E.E.S. #	O.E.M. #	No. of Contacts	Contact Arrangement	STEM ONLY		
				S.E.E.S. #	O.E.M. #	Length
MRP-11A	P4349	6	2-3-5 N.O., 1-4-6-N.C.	MRP-1A	23247	10"
MRP-11B	P4350	6	1-2-3-5 N.O., 4-6 N.C.	MRP-1	23248	10"
MRP-11C	P4351	6	1-2-3-5-6 N.O., 4 N.C.	MRP-2	23249	8-3/4"
MRP-11D	P4352	4	4 N.O., 1-2-3 N.C.	MRP-2A	23250	7"
MRP-11E	P4353	4	3-4 N.O., 1-2 N.C.	MRP-2B	23251	7"
MRP-11F	P4354	4	2-3-4 N.O., 1 N.C.	MRP-3	23252	7"
MRP-11G	P4355	4	1-2-3-4 N.O., None N.C.	MRP-3A	23253	7"



MRP-4



MRP-5



MRP-5A



MRP-6



MRP-7



MRP-8



MRP-10



MRP-9A



MRP-11A

MRP-3

MRP-3A



MRP-10C

S.E.E.S. #	O.E.M. #	Description
MRP-4	18594A	Movable contact for assemblies
MRP-5	18595A	Stationary contact for above stem and contact assemblies
MRP-5A	22239	Stud , 1-1/4" long
MRP-5B	19648	Stud , 1" long
MRP-6	16807	Stem guide
MRP-7	11111	Washer , 3/4" dia. x 1/16" for above assemblies
MRP-8	2881-149	Spring for contact, 1/2" for above assemblies
MRP-9	2881-148	Spring for contact, 1-5/8" for above assemblies
MRP-10	16929	Solenoid coil assembly , 110V
MRP-11	16910	Solenoid coil assembly , 220V
MRP-9A	2881-192	Return Spring for top of stem
MRP-10C		Solenoid Assembly , includes one of each: MRP-10, MRP-9A, and MRP-10A
MRP-10A	41782	Plunger coupler , attaches to stem MRP-10C Solenoid assembly
MRP-15	14727-001, 14726-004	Contact kit , used on P, U, D, SB, contactors and 2 speed AC Controllers, two flat silver stationary contacts, pointed silver movable contact
MRP-16	14727-002, 14726-002	Contact kit , used on P, U, D, SB, contactors and 2 speed AC Controllers, flat silver movable contact
MRP-15A	10475	Stem Guide , angle
MPC-50	65726-002	Contactors , 550V, 3-pole, 110A, contact kit is (2) US90235002 and (1) US90691002



MRP-10A



MRP-15



MRP-16



MRP-15A



Relay Parts



MRP-12A



MRP-21

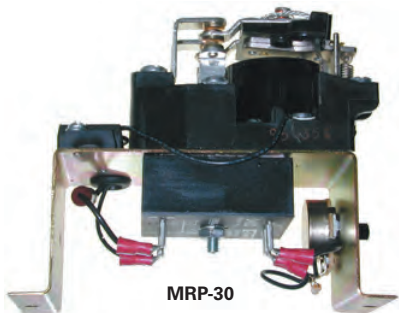

MRP-30



MRP-29A

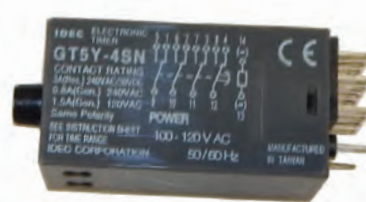

MRP-20

Timers

S.E.E.S. #	O.E.M. #	Description
MRP-12A	P16553	Timer, 0-2 min., 120 VAC. Replaces P8555, P8556, P12731
MRP-20	PN47261	Timer, plug-in, .2 - 10 seconds
MRP-21	PN47262	Timer, plug-in, 1.2 - 120 seconds
MRP-22	PN47263	Timer, plug-in, .9 - 90 seconds, 120 VAC, external adjustment

Adjustable 0-3 Sec. Timers

S.E.E.S. #	O.E.M. #	Description
MRP-30	P5362	Timer, capacitor, 230 VAC, time upon energization
MRP-31	P5363	Timer, capacitor, 110 VDC, time upon energization
MRP-32	P7159	Timer, capacitor, 115 VAC, time upon de-energization
MRP-33	P5361	Timer, capacitor, 115 VAC, time upon energization

S.E.E.S. #	O.E.M. #	Description
MRP-29A	P28848	Reverse Phase Relay Kit, 208-240 VAC
MRP-29B	P28849	Reverse Phase Relay Kit, 440-480 VAC
MRP-29C	P28850	Reverse Phase Relay Kit, 575-600 VAC
MDO-16A	P8571	Amplifier unit for electric eye

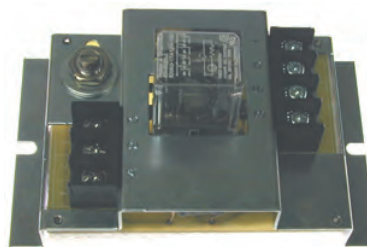

MDO-16A

Relay Parts

S.E.E.S. #	O.E.M. #	Description
PR-12	42844, 36244, 45516	Plug-in relay, 4 PDT, 120 VAC
PR-66A	43444	Plug-in relay, 4 PDT, 24 VAC
PR-25	43744	Plug-in relay, 4 PDT, 110 VDC
PR-12B	45377	Plug-in relay, 4 PDT, 12 VAC



PR-12B



MRP-12B

Relay with Button Actuator and Light

S.E.E.S. #	O.E.M. #	Description
MRP-12B	46344	Relay, 120 VAC, DPDT, 10 Amp contacts



MRP-120



MRP-120A



MRP-120B

S.E.E.S. #	O.E.M. #	Description
MRP-120	P16723	Relay assembly, 4 PDT, with harness and bracket to replace leaf type Guardian relays
MRP-120A	P16724	Double relay assembly with two, 4 PDT relays
MRP-120B	P14010-34	Wiring harness, for relay MRP-12
MRP-120C		Single Bracket for MRP-120 assembly
MRP-121A		Double bracket for MRP-120A assembly

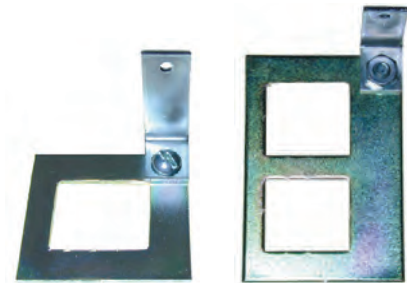

MRP-120C

MRP-121A

Power Relays

S.E.E.S. #	O.E.M. #	Description
PR-7	19238, PR2678	Relay, DPDT 120 VAC
PR-9	19240, PR2679	Relay, DPDT 240 VAC
PR-3	26120, PR2680	Relay, DPDT 110 VDC
PR-6	28383, PR2900	Relay, DPDT 24 VAC

■ See a complete listing of Relays starting on page 283.



PR-7

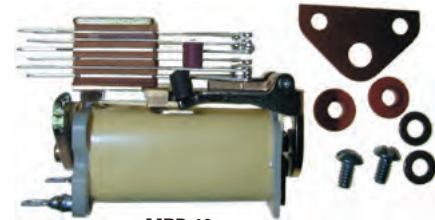

MRP-40

S.E.E.S. #	O.E.M. #	Description
MRP-40	33210	Relay, 110 VAC, 450 Ohm, 4 PDT
MRP-41	33211	Relay, 110 VAC, DPDT
MRP-42	33212	Relay, 24 VAC
MRP-43	33213	Relay, 24 VDC, 500 Ohm
MRP-44	33214	Relay, 24 VDC, 300 Ohm
MRP-45	33215	Relay, 24 VDC
MRP-47	33217	Relay, 12 VDC
MRP-48	33218	Relay, 12 VDC, 150 Ohm
MRP-49	94027001	Auxiliary Contact Assembly, 1 N.C., 1 N.O.
MRP-50	US90507	Fan, 127 CFM 230VAC 50/60 hz enclosed 4-1/2" SQ.



MRP-49



MRP-50



Transformers

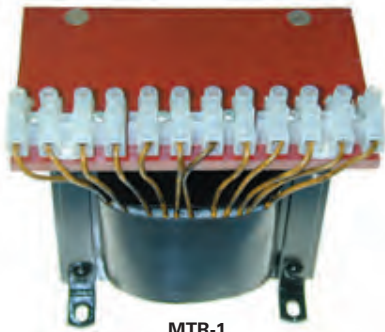

MTR-1

S.E.E.S. #	O.E.M. #	Description
MTR-1	28600	Transformer, 250VA, Primary 200-480V, Secondary 109-218V
MTR-2	28601	Transformer, 500VA, Primary 200-480V, Secondary 109-218V
MTR-3	28602	Transformer, 1000VA, Primary 200-480V, Secondary 109-218V
MTR-4	A46208	Transformer for door operator
MTR-5	US65115	Transformer, 150V PRI 120 Sec 5V, 6.8V, 8V, 10V, 12V, 15V



MTR-2



MTR-3

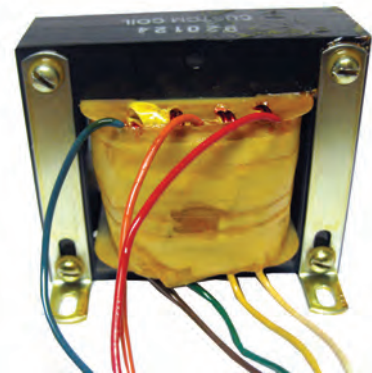

MTR-5

Valve Parts



MV-1

S.E.E.S. #	O.E.M. #	Description
MV-1	P9115	Valve, up start 1/16" needle orifice
MV-2	P9116	Valve, soft stop 1/8" needle orifice
MV-3	P9118	Needle and core assembly, for USUL valve
MV-3A	28949	Orifice needle
MV-5	2881-170	Spring washer for USUL
DV-2A	9724722, 28948	Solenoid Seat, threaded, replaces MV-4



MV-3



MV-3A



DV-2A

Encoders and Tachometers

S.E.E.S. #	O.E.M. #	Description
MW-14	P28670	Encoder Assembly
MW-14A	US2881223	Spring , Tension for Encoder MW-14
MW-11E	P7087	Roller , 10" for encoder assembly MW-14
MMP-120	62675-001, US63099001	Encoder , used on MW-14, 12 VDC, 200 Pulse Counts per revolution
MMP-120A	US63099002	Encoder , 240 counts per revolution, 1/4" shaft
MMP-120C	US63099004	Encoder , 2048 counts per revolution, 5V
MMP-120D	US63099006	Encoder , 5000 counts per revolution, flange mount
MMP-121	US63099003	Encoder , 2048 counts per revolution, 12V
MMP-100	45407	Tach generator , DC 100V per 1000 RPM, flange mount
MMP-100A	US48574	Flexible Tach Coupling , #48574, 5/16" to 5/16"
MMP-100B	AR125-16-16	Flexible Tach Coupling , 1/2" - 1/2" with set screw
MMP-100C		Flexible Coupling , 3/8" to 1/2"
HCB-6	US48412003	Brush for MMP-100
MMP-122	US90665001	Flex Steel Coupling , 1/4" to 1/4"
MMP-123	US90665002	Flexible Coupling , 1/4" I.D. to 3/8"
MMP-123A	US90665001	Flexible Coupling , Steel 1/4" x 1/4", non split, set screw type
MMP-123B	ACR112-16-8	Flexible Coupling , Steel, 1/4" x 1/2"
MMP-124	US90655003	Flexible Coupling , 3/8" x 3/8", non split
MMP-101	45407	Tachometer , foot mounting tachometer 100 VDC per 1000 RPM
MMP-102	US60823	Tachometer Sheave , 4"
MMP-110	US63099007	Tach generator , Incremental 61531-004 optical encoder, 100V per 1000 RPM, flange mount
MMP-200	US90665002	O-Ring , for Encoder
KOSS-1	KM616254G04	Tachometer , 60 VDC per 1000 RPM



MW-14



MW-11E



MMP-120



MMP-121



MMP-120A



MMP-120D



MMP-121



MMP-123



MMP-100



MMP-100A



MMP-100B



MMP-100C



MMP-123A



MMP-124



MMP-101



MMP-110



MMP-200



KOSS-1



Selector Parts



MS-1



MS-1A

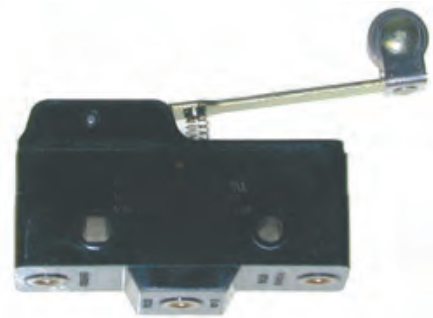

MS-2



MS-2A



MS-3



MS-5

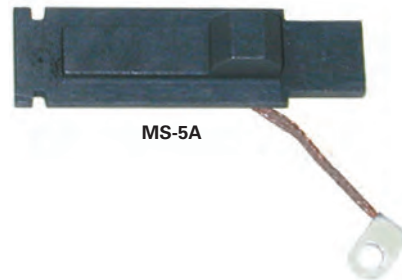

MS-5A



MS-5B

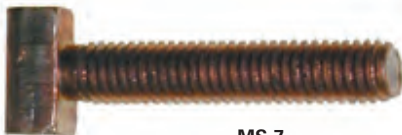

MS-7

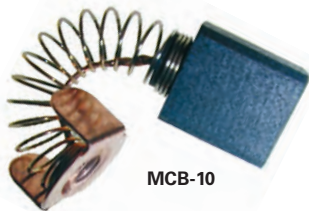

MCB-10

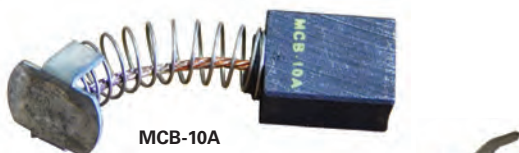

MCB-10A

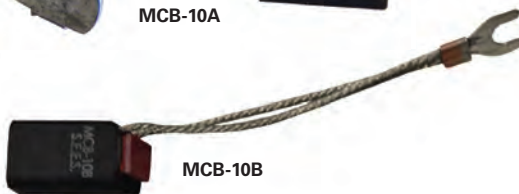

MCB-10B

S.E.E.S. #	O.E.M. #	Description
MS-1	P2407A	Selector Idler Sheave, 6"
MS-1A		Mounting Bracket with pin for sheave
MS-2	15926	Micro Switch for wishbone selector
MS-2A	5PA-2	Switch Cover for screw terminal type switches
MS-3	2881-61	Spring for floor selector cable
MS-5	42977	Contact, with shunt, carbon face 1/16"
MS-5A	42978	Contact, with shunt, carbon face 1/4"
MS-5B	42979	Contact, with shunt, carbon face 1-9/16"
MS-7	29734	T-Contact bar
MCB-10	42979	Brush, for S.E.E.S motor MDO-29A, 1/4" x 3/8" x 7/16"
MCB-10A		Brush, Replacement for SEES Imperial only MDO-29A/KDO-002
MCB-10B		Brush, Replacement for SEES Imperial only MDO-29A/KDO-002

Safety Edges



MDO-6D



MDO-6C



MDO-8

S.E.E.S. #	O.E.M. #	Description
MDO-6A	MAP252	Connecting rod assembly
MDO-6C	MA1229	Ball rod end R.H. thread
MDO-6D	MA1724	Ball rod end L.H. thread
MDO-8	MA1687	Arm, aluminum pick-up arm, 3/4" x 3/16"
MSE-3	P31360	Lower pivot arm
MSE-1B	MA-165	Micro Switch
MSE-1D	101033, MA-1033	Stud (upper)

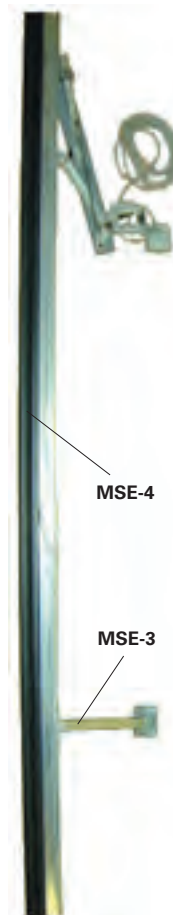

MSE-4

MSE-3



MDO-6D

MDO-6A



MSE-3



MSE-1B



MSE-1D

Door Hanger Rollers

S.E.E.S. #	Description
 KOHR-1	Roller , Hanger 94mm x 19mm, bearing 6203 groove diameter, 84.5mm
 KOHR-2	Roller , Hanger 56mm x 15.5mm, bearing 6202
 KOHR-2A	Roller , Hanger 56mm x 15mm Brg 6202, Alum Hub w Urethane
 KOHR-3	Roller , Nylon Hanger 62mm x 16mm, bearing 6203, groove diameter, 52mm, ID:17mm
 KOHR-4	Roller , Nylon Hanger 44mm x 12mm M8, groove diameter 38mm, ID:12mm
 KOHR-5	Landing Door Hanger Roller , 74mm x 16mm M10 GD: 64mm, bearing 6203
 KOHR-6	Roller , Hanger with Eccentric 94mm x 19mm, bearing 6203, groove diameter, 84.5mm
 KOHR-7	Roller , Retainer for Hanger 46mm x 16mm, bearing 6001, groove diameter, 39mm, 6G-M12
 KOHR-8	Roller , Retainer for SELCOM Hanger 43mm x 16mm, bearing 6202, with Eccentric Shaft
 KOHR-9	Roller , for Hanger 44mm x 16mm groove diameter, 38mm, M10
 KOHR-10	Roller , Retaining for Hanger 36.5mm x 15mm groove diameter, 31mm, 6G-M10
 KOHR-11	Roller , Retaining for Hanger 44mm x 12mm groove diameter, 38mm, M8
 KOHR-12	Roller , Eccentric for Hanger 46mm x 17mm, bearing 6201, groove diameter, 39mm
 KOHR-14	Roller , Hanger, 59.6mm x 13mm, bearing 6002Z
 KOHR-15	Roller , Hanger, 59.6mm x 13mm, bearing 6002Z
 KOHR-16	Roller , Hanger, 68mm x 17mm, bearing 6203Z
 KOHR-17	Roller , Hanger, 55.5mm x 20mm, bearing 6202Z
 KOHR-18	Roller , Hanger, 85mm x 19mm, bearing 6203Z
 KOLO-1	Roller , for Door Lock 31mm x 17.5mm ID:12
 KOLO-2	Roller , Plastic for Door Lock 31mm x 17.5m ID:15.5
 KOLO-3	Roller , for SELCOM Door Lock 40mm x 15mm ID:12
 KOLO-4	Roller Assembly , for Door Lock Unit, L.H. Bracket Set
 KOLO-9	Roller Assembly , for Door Lock Unit, R.H. Bracket Set
 KOLO-2	Lock Roller , KONE 31mm x 12mm x 17mm
 KOLO-3	Roller , Hanger ADM/ADR 70mm x 17mm with Shaft
 KOLO-4	Roller , 30mm x 12mm, bearing 608z
 KOLO-9	Roller , for SELCOM Hanger 64mm x 11mm, bearing 6202 ID:10
 KOWH-19	Hanger Roller , SELCOM 86mm x 16mm, 6203 Brg
 KOWH-20	Wheel , 50mm x 12mm, GD:43.5 ID:10mm, bearing 6002
 KOWH-20A	Wheel , 48mm x 9mm, bearing 608, GD:40 ID:8
 KOWH-21	Wheel , CWT R.G 3.937" O.D. Yellow
 KOWH-22	Roller , Hanger 3-5/16" O.D. x .6693" I.D., with 7/16-20 Shaft
 KW-003	Roller , Hanger 3-5/16" O.D. x .6693" I.D., with 7/16-20 Ecc Shaft
 KW-005	Roller , Hanger ADM/ADR 70mm x 17mm w/ Shaft
 KW-005E	

Rollers

S.E.E.S. #	O.E.M. #	Description
MW-7	MAP341, P31341	Roller , Hatch door roller, 2-7/8"
MW-7C		Shaft , For MW-7 and MW-8 Hatch Rollers
MW-7E		Roller , Hatch door roller, 2-7/8", with ECC
MW-7-AL	M-411 AL	Hatch Door Roller , 2-7/8" Alum Hub Straight Shaft, 7/16-20
MW-8	MAP344, P31344	Roller , Car door roller, 3-11/16"
MW-8B	MAP374 Less Shaft	Car Door Hanger Roller , 3-11/16" No Shaft
MW-8-HDW		Hardware , for MW-7 and MW-8 rollers, Bag of 4
MW-8-AL	MTGMP-31344-AL	Car Door Roller , 3-11/16" w/ Alum Hub Straight Shaft, 7/16-20 Thrd
MW-8E	P022237	Roller , Car door roller, 3-11/16", with eccentric shaft
MW-8E-AL		Roller , Car Door, 3-11/16" with Alum Hub Eccentric Shaft, 7/16-20

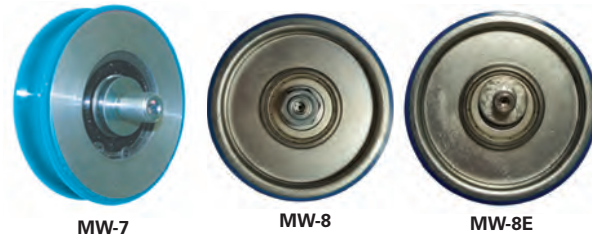

MW-7

MW-8

MW-8E

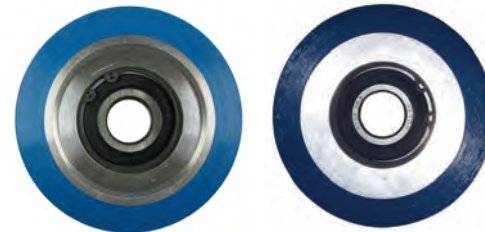

MW-3B

MW-3D

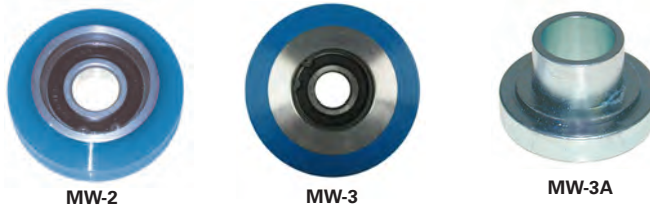

MW-2

MW-3

MW-3A



MW-4

S.E.E.S. #	O.E.M. #	Description
MW-2	P2964	Roller guide wheel , 3" O.D., 1/2" tire face, .7874" bearing I.D.
MW-3	P12963	Roller guide wheel , 3-15/16", O.D., 7/8" wide, .7874" bearing I.D.
MW-3A	16605	Roller adaptor , bushing 5/8" x 1-3/8" x 13/16", for roller guide wheel MW-3, used on roller guide assemblies
MW-3B	P5985	Roller guide wheel , 3-15/16" O.D. 1-1/8" wide, .7874" bearing I.D.
MW-3D		Roller guide wheel , 3-15/16" O.D. x 7/8" W x 1/2" Face, .7874" I.D.
MW-3E		Roller Adaptor , 1-3/8" O.D. x 1/2" I.D. x 13/16" W
MW-3R	P12908	Roller guide assembly , 3-15/16" wheels
MW-4	P2654, M422	Roller guide wheel , 4-3/8" O.D. 7/8" wide with tapered face to 1/2", .7874" I.D.
URG-004		Roller Guide Assembly , 10" universal 3-wheel
URG-004A		Bushing , Bumper for URG-004
MW-11	P7087	Roller guide wheel , 10" O.D., wheel with polyurethane tire, .9843" bearing I.D. for P28305 assembly MW-11AK
MW-11AK	P28305	Roller guide assembly , 10" 3 wheel replacement to P28305, kit to replace roller guide assembly with 10" wheels
MW-11B		Adaptor Plate , 10" 3 wheel roller guide conversion

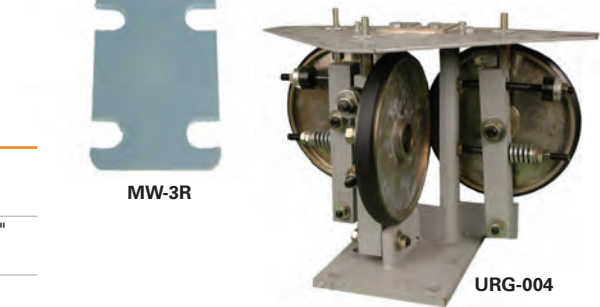

MW-3R

URG-004

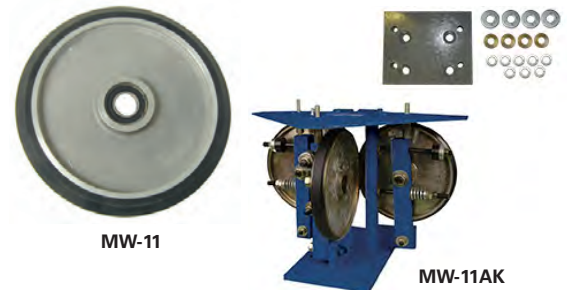

MW-11

MW-11AK



MW-11B

Roller and Slide Guides

S.E.E.S. #	O.E.M. #	Description
MW-5	P3174	Roller Guide Wheel , 6-1/2" O.D., .9843" bearing I.D., 1-1/4" tire width
MW-6	P2789	Roller Guide Wheel , 6-1/2" O.D., .9843" bearing I.D., 1-1/4" tire width tapered to 1/2" wide tire face
URG-002	P25220	Roller Guide Assembly , 6" universal 3-wheel
MW-6AK	P25220, USP25699	Roller Guide Assembly , 6-1/2" 3-wheel, kit to replace roller guide assembly with 6" wheels
MW-6B	USP25699	Mounting Plate , for 6" 3 wheel conversion
MW-7	MAP341	Roller , Hatch door roller, 2-7/8"
MW-8	MAP344, P31344	Roller , Car door roller, 3-11/16"
MW-8E	P022237	Roller , Car door roller, 3-11/16", with eccentric shaft
MW-10	P12592	Roller Guide Wheel , 7-3/4" O.D., .9843" bearing I.D.
MW-10H	P12592 90 Duro	Roller Guide Wheel , 7-3/4" O.D., 90 Duro
MW-12	513962-00F	Roller Guide Wheel , 3-1/4" O.D. with two bearings, 5/8" I.D., 1/2" tire face
MW-13	513962-00S	Roller Guide Wheel , 3-1/4" O.D. with two bearings, 5/8" I.D., 7/8" tire face
MW-13A		Roller Guide Wheel , 2-7/8" O.D. Piston Follower Double 99502H bearing 5/8" Bore
MW-13B		Shaft , Eccentric for MW-13, 1/2-13 Thrd
MW-11E	P7087	Roller , 10" for encoder assembly MW-14
KOGS-1		Guide Shoe , Black 16mm
KOGS-2		Guide Shoe , Black 10mm
KOGS-3		Guide Shoe Insert , Green, 128mm x 34mm, for 16mm Rail
KOGS-4		Guide Shoe Insert , Green, 128mm x 34mm, for 10mm Rail



MW-5



URG-002

*to replace P25220



MW-6



MW-10

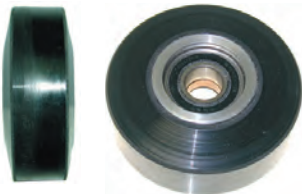

MW-13

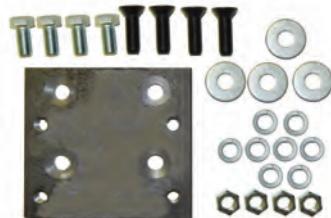

MW-6B

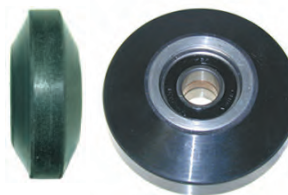

MW-12



MW-11E



KOGS-1



KOGS-2



KOGS-3



KOGS-4

Roller and Slide Guides

S.E.E.S. #	O.E.M. #	Description
KOGS-5		Guide Shoe Insert, 120mm x 22mm x 29mm
KOGS-6		Guide Shoe Insert
KOGS-7		Roller Guide Assembly, Spring 3 wheel, 80mm O.D./10mm rail
KOGS-7A		Roller Guide Assembly, Spring 3 wheel, 80mm O.D./16mm rail
KOGS-8		Roller, for Guide Shoe, 125mm x 26mm x 2mm, brg. 6003
KOGS-8A		Roller, Guide Roller 125mm
KOGS-9		Roller, for Guide Shoe, 150mm x 38mm x 2mm, bearing 6003 ID:17mm
KOGS-9A	KM600655G03	Roller Guide Assembly, 5.91" x 1.5" (150mmx 38mm x 2mm) 6003 ID:17mm
KOGS-10		Roller, for Guide Shoe, 80mm x 28mm x 2mm, bearing 6203
KOGS-13		Guild Shoe Insert, 140 x 30 x 16
KOGS-15A	36215	Arm, for Roller Guide assembly
KOGS-17		Roller, Kone Guide Shoe Roller, 195mm x 38mm x 2-6003
KOGS-18		Roller, Kone Guide Shoe Roller, 80 mm x 28mm x 2-6203
KM-001	KM-433371H29	Shoe Insert, folding slide
KOOC-1		Oil Can, Square
KOOC-2		Oil Can, Square
KSG-001	KM600641H16	Kone Slide Guide, insert for SLG7 CWT Guide, 16mm
KSG-002	KM652435G16	Kone Slide Guide, assembly CWT SLG7 Guide, 16mm
WIDO-001		Landing Roller Unit, AMDNA-V2, L.H.
WIDO-001A		Landing Roller Unit, AMDNA-V2, L.H. with Linkage Arms
WIDO-002		Landing Roller Unit, AMDNA-V2, R.H.
WIDO-002A		Landing Roller Unit, AMDNA-V2, R.H. with Linkage Arms
WIDO-003		Mounting Plate, for Witurr PU Roller Assembly for Renova Kits



KOGS-5



KOGS-6



KOGS-7



KOGS-8



KOGS-9



KOGS-15A



KOGS-18



KM-001



KOOC-1



KOOC-2



KOGS-13

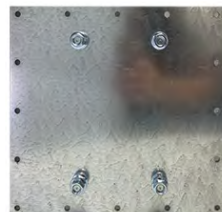

WIDO-003

Features

- **Long Lasting** Polyurethane Rollers
- **Strong** cast iron base and roller arms
- **Adjustable** tensioning springs for light load or heavy load applications
- Offering a superior **SMOOTH** ride for passengers



URG-001



URG-002



URG-004



URG-005



URG-006



MIS-143S



MIS-142

SEES UNIVERSAL ROLLER GUIDE Roller Guides

S.E.E.S. #	O.E.M. #	Description
URG-001	ED02000	3-1/4" Universal 3 wheel roller guide Model D
URG-002	EB02100	6" Universal 3 wheel roller guide Model B
URG-006	EC18400	3-1/4" Universal 6 wheel roller guide Model C

Replacement Rollers

S.E.E.S. #	O.E.M. #	Description
MIS-143S	EC18405	3-1/4" diameter, .4724 bore wheel
MIS-142	EA18359	6" diameter, .7874 bore wheel

Cover Plates

S.E.E.S. #	O.E.M. #	Description
URG-001C	ED02013	Cover Plate Model D
URG-002C	EB02123	Cover Plate Model B
URG-005C	EA18333	Cover Plate Model A
URG-006C	EC18403	Cover Plate Model C
URG-001-HDW		Bolts, for Rollers, Set of 3 for URG-001



URG-001C



URG-002C



MITSUBISHI

QUICK LOCATOR GUIDE

Car Signal Components	710
Lamp	710
Pushbutton Assemblies	710
Sensor	710
Contactors	713
Door Parts	710-711
Contacts	711
Door Gibs	710
Door Locks	711
Encoder	710
Key	711
Sheaves	710
Silicon Controller	710
Fan Assembly	712
Leveling Switches	713
Limit Switches	713
Printed Circuit Boards	712
Rollers and Guides	711-712
Door Lock Rollers	711
Door Vane Roller	711
Guide Shoes	712
Hanger Rollers	711
Oilers	712

MITSUBISHI

Car Signal Components



MIBT-1



MIBT-1-ARROW



MIBT-2



MIBT-3



MIBT-4



MIBT-5



MIBT-5-ARROW



MIBT-5-5



MIBT-6-BLANK



MIBT-7



MISS-10



MISLI-1

S.E.E.S. #	Description
MIBT-1	Pushbutton, for SPVF, MTB
MIBT-1-ARROW	Pushbutton, for SPVF, MTB Marked "Arrow"
MIBT-2	Pushbutton, for D51.31A Series
MIBT-3	Pushbutton, for GPS Series LHB007 008
MIBT-4	Pushbutton, for GPS Series LHB005 006
MIBT-5	Pushbutton, D160 12-24V Blank Marking
MIBT-5-ARROW	Pushbutton, D160 12-24V Marked "Arrow"
MIBT-5-1	Pushbutton, D160 12-24V Marked "1"
MIBT-5-2	Pushbutton, D160 12-24V Marked "2"
MIBT-5-3	Pushbutton, D160 12-24V Marked "3"
MIBT-5-4	Pushbutton, D160 12-24V Marked "4"
MIBT-5-5	Pushbutton, D160 12-24V Marked "5"
MIBT-6-BLANK	LED Pushbutton, Mitsubishi, Red Light
MIBT-7	Pushbutton, with blue light
MISS-2	Sensor, YG-25 Magnetic
MISS-3	Sensor, YG-1A Magnetic
MISS-10	Magnetic Proximity Switch, PSMO-25G1
MISLI-1	Light, 24V

Door Parts



MICOD-5



MIDS-1



MIEP-2



MIEP-3



MIEP-4



MIWH-2



MIWH-3



MIWH-9

S.E.E.S. #	O.E.M. #	Description
MICOD-5	X65AC-31	Encoder, Rotary PKT1045-512-J30F
MIWM-1	YVP90-6	Door Motor, Mitsubishi YVP90-6
MIWM-2	YVP90-6S	Door Motor, Mitsubishi YVP90-6S
MIDS-1	YA098C118G01	Door Gib, 62mm x 40mm x 11mm
MIEP-2		Silicon Controller
MIEP-3	F726201, RM50TC-2H	Silicon Controller
MIEP-4		Silicon Controller
MIF-1	ZFB9B110	Fan, Mitsubishi 110V # ZFB9B110
MIWH-2		Sheave, 90mm O.D., bearing 6200Z
MIWH-3		Sheave, 60mm O.D., Nylon
MIWH-9		Sheave, 90mm O.D. x 11mm, bearing 6200RS

Door Parts

S.E.E.S. #	O.E.M. #	Description
MIK-1	MIT900	Key, MIT900
MIK-2	MIT932	Key, MIT932
MILO-1	D161001C101	Door Lock
MILO-1R		Door Lock
MILO-2		Power Lock, HOP
MILO-3		Power Lock, COP
MILO-4		Contact, For 161 Door Lock
MILO-4WB		Wheel, For 161 Door Lock
MILO-5		Lock, Triangular
MILO-5K	B286858	Key, Triangular
MILO-7	JC1363	Lock, for Side Door
MISLO-1		Lock, Large Triangle for Freight Elevator
MIPP-1		Junction
MIPS-1	X59LX-30	Paneling Sheave
MISRP-1		Rubber Cushion, 64mm x 55mm, ID:32mm
MITR-1		Oil Seal for traction machine
MITBLT-001		Belt, for Mitsubishi



Rollers and Guides

S.E.E.S. #	O.E.M. #	Description
MIDV-1		Roller, for Door Vane 46mm x 13mm, ID:12mm
MIHR-1	YA052C703G01	Roller, for Hanger, 56mm O.D., bearing 6201
MIHR-2	YA006C621G01	Roller, for Hanger, 72mm O.D., bearing 6202
MIHR-3		Nut, for Hanger Roller
MIHR-4	YA052C703G01	Roller, for Hanger with Collar 56mm x 14mm, bearing 6201
MILO-4W		Roller, for 161 Door Lock
MILO-4WB		Roller, for 161 Door Lock
MILO-4B		Bearing, for 161 Door Lock
MIHR-5		Roller, Retaining for Car Door Hanger Assembly 40mm x 12mm, 6g-M8
MILO-9		Roller, for Feight Elevator Door Lock 60mm x 16mm, ID:15mm, bearing 6202
MISLO-2		Roller, for FUJI Door Lock 50mm x 20mm, ID:12mm
MIDH-1		Hanger Assembly, for Landing Door
MIDH-2		Hanger Assembly, for Car Door



Rollers and Guides



MIGS-1



MIGS-3



MIGS-5



MIGS-6



MIGS-7



MIGS-8



MIGS-9



MIGS-10



MIGS-11



MIOC-1



MIOC-2



MIOC-3

S.E.E.S. #	O.E.M. #	Description
MIGS-1		Guide Shoe
MIGS-1A		Mitsubishi Head Guide, For CW 16mm
MIGS-3	YA141B237G03	Guide Shoe, for High Speed 2.5m/s
MIGS-5		Guide Shoe, Sliding, 16mm
MIGS-6		Guide Shoe
MIGS-7		Guide Shoe Insert 120mm x 28mm x 9mm
MIGS-8		Guide Shoe Insert 120mm x 28mm x 16mm
MIGS-9		Roller, for Guide Shoe 80mm x 26.5mm, ID:17mm, bearing 6203
MIGS-10		Guide Shoe Insert, Set of 3 (1) 230mm x 35mm x 9mm, (2) 230mm x 30mm x 9mm
MIGS-11		Guide Shoe Insert, Set of 3 (1) 230mm x 34mm x 9mm (2) 230mm x 30mm x 9mm
MIOC-1		Oil Can, Large, GO2
MIOC-2		Oil Can, Square
MIOC-3		Oil Collector

Fans



MIF-3

S.E.E.S. #	O.E.M. #	Description
MIF-3	ZQF-330	Fan, Mitsubishi ZQF-330

Printed Circuit Boards



MIHOP-28



MIHOP-30

S.E.E.S. #	O.E.M. #	Description
MIHOP-28	KALEX3K688	PCB, Display, SCLC-V1.1 HOP
MIHOP-30	YE601B704B-01	PCB, TOS-PCB-014
MIDOB-7	DOR-120	PCB, Door Operator, Mitsubishi DOR-120

Limit / Leveling Switches

S.E.E.S. #	O.E.M. #	Description
MISS-1		Switch, YG-29 Magnetic Proximity
MISSW-1	TR231-11YU1930	Switch, LX2-411 Limit Auto Return
MISSW-2	ZR231-11Yr1881	Switch, LX2-412 Limit Non Auto Return
MISSW-3	TK231-11YU	Switch, LX2-413 Limit Auto Return
MISSW-4	ZS231-11Yr	Switch, LX2-414 Limit Non Auto Return
MISSW-5	TV231-11r	Switch, LX2-415 Limit With Small Roller Auto Return
MISSW-6	TV231-11r	Switch, LX2-415 Limit with Big Roller, Auto Return
MISSW-7		Switch, LX2-416 Limit
MISSW-9		Switch, UKS Limit Non Auto Return
MISSW-10		Switch, Slider
MISW-1		Switch, for Car Door DS-131
MISW-2		Switch, for Car Door
MISW-3	LXP1-020-1A	Switch, Limit
MISW-4		Switch, for Landing Door for GPS III
MISW-5-M		Magnet, Actuating Device for Leveling Switch
MILS-1	EL-1370	Switch, Limit



MISS-1



MISSW-1



MISSW-2



MISSW-3



MISSW-4



MISSW-5



MISSW-6



MISSW-7



MISSW-9



MISW-1



MISW-2



MISW-3



MISW-4



MICT-1



MICT-2



MICT-3



MILS-1

Contactors

S.E.E.S. #	O.E.M. #	Description
MICT-1	BH752Y922H03	Contactor, for SD-N50 GPS
MICT-2		Contactor, SD-N35
MICT-3		Contactor, S-K20 Magnetic
MILO-4		Contact, for 161 Door Lock
MILO-6	H131001C138G01	Contact, for Door Lock



MILO-4



MILO-6

LOSING MONEY ON CALL BACKS?

Introducing...

SMARTORK

Elevator Hoistway
Door Closer



What does it do?

As the door closes, the innovative SMARTORK overcomes wind resistance by design. The SMARTORK, with its helical groove design, actually regains tension as it closes the door. SMARTORK provides more tension in the "door-close" cycle than it does in the "door-open" cycle. It's easy to install; just remove the "Old Style" unit and install the SMARTORK as a replacement. Call today and ask for SEES part number:

MIS-124-ST

Don't forget your brackets:

MIS-124-ST-BK

Contact Us!

800.526.0026

SMARTORK™



800.526.0026

info@seesinc.com

www.facebook.com/SEESinc

Visit Our Website:
www.seesinc.com

- ▶ The "Uni-hub" allows for easy installation
- ▶ SMARTORK saves money on non-chargeable and non-billable hours for elevator companies dealing with "Wind Resistance Issues"
- ▶ Reliable solution to nuisance call-backs
- ▶ Maintenance calls to add or remove "wraps" will virtually be a thing of the past once the SMARTORK is installed
- ▶ Rated "Green" under Energy Efficiency guidelines
- ▶ 3rd party tests over one-million cycles with virtually constant torque verify extended service-life tests
- ▶ 2 year warranty
- ▶ Made in the USA
- ▶ Acts as a safety device by securing door lock mechanisms

OTIS

QUICK LOCATOR GUIDE

Brushes And Brush Holders	736-738
Capacitors	760
Car Signal Components	716-728
Button Components	716-720
Button Module	724
Direction Indicator Panels	722
Emergency Stop Switches	723
Gongs	727
Jewel Module	725
Key Switches, Keys	726-728
Stainless Steel Faceplates	716
Switches, Pushbutton	718, 721
Car Switch Components	739
Coils	729-735
Connectors, Shunts	756
Contacts, Carbon and Copper	738-740
Contacts and Paddle Contacts	741-742
Detector Shields	757
Door Parts and Equipment	742-756
Door Locks	745-747
Gibs, Guides	752-754
Keys, Escutcheons	750
Interlock Switches	748
Limit Switches, Floor Switches	749
Motors	755
Spirators, Reel Closer	751
Machine Parts	777-778
Printed Circuit Boards	758-759
Rectifiers	762
Relay Parts	765-771
Resistors	761
Safety Edge Components	777
Selector Parts	772-776
Transformers	762-763
Wheels and Rollers	779-784
Guide Shoes	781-782
Hanger Rollers & Assemblies	779-780
Roller Guide Assemblies	779-783

Car Signal Components

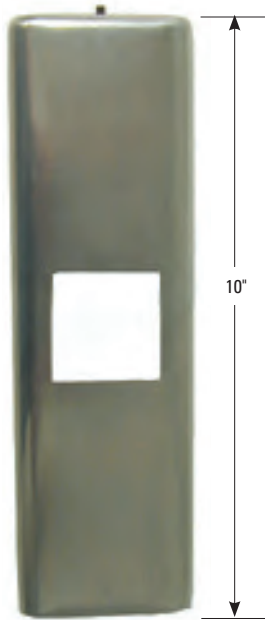

OB-1

Stainless Steel Faceplates

S.E.E.S. #	O.E.M. #	Description
OB-1	147FD1-25	Hall plate, only, for one square button (1-3/4" hole), terminal floors
OB-3	147FD7-25	Hall plate, only, for one round button, (1-1/2" hole) terminal floors



OB-16



OB-17



OB-18



OB-34



OB-22



OB-22A

Buttons

S.E.E.S. #	O.E.M. #	Description
OB-16	B306GC2	Base, square, clear butyrate
OB-17	306JG1	Halo, button, 1"
OB-18	306JH1	Base, clear butyrate
OB-34	306KH1	Base, round, clear, for OB-33
OB-34A	306KH2	Base, round, frosted, for OB-33
OB-22	278AN3	Shield, Square tube shield, R.H.
OB-22A	278AN4	Shield, Square tube shield, L.H.
OB-33-	323BL2	Button, Electronic touch button, Black with white marking, 7/8" diameter with threaded stem, specify marking, i.e. OB-33-ARROW
OB-19-	323BH2	Button, Black square button with white markings, 7/8" specify marking, i.e. OB-19-ARROW
OB-20	72CG1	Nut, Touch button nut, 5-40 tap thread
OB-21	90WE14	Spring, cone shaped
OB-7	B6849C7	Base, hall terminal, single socket, for touch buttons
OB-8	B6849C5	Base, intermediate hall, double socket, for touch buttons
OB-8A	B6849C6	Base, car station, double socket, for touch buttons



OB-33



OB-19



OB-20



OB-21



OB-7



OB-8

Car Signal Components

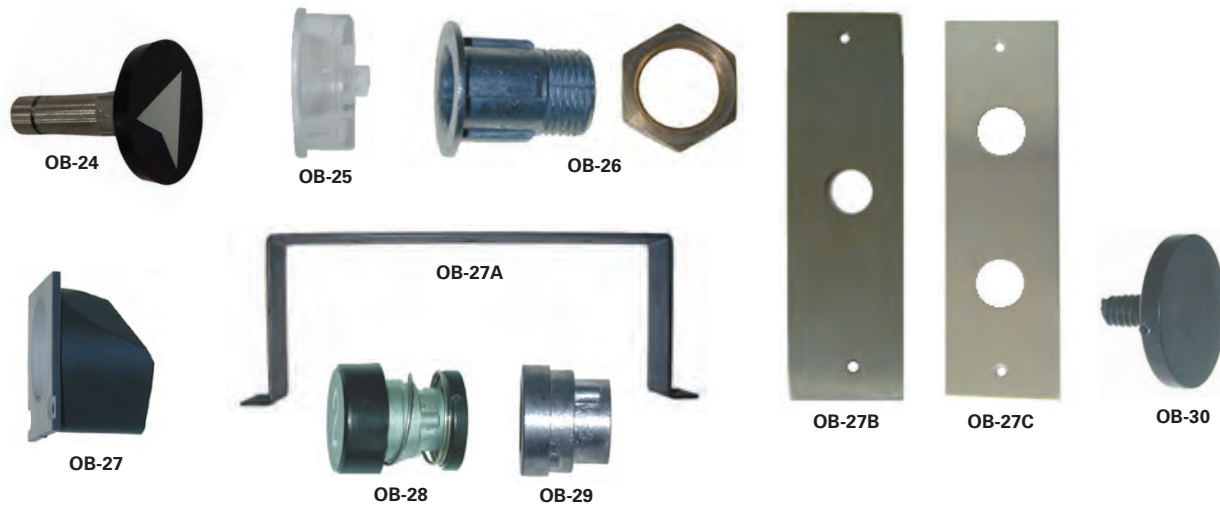

S.E.E.S. #	O.E.M. #	Description
OB-24-	A323BP1	Button , 7/8" dia. with square shaft, black with white markings, specify marking. i.e. OB-24-ARROW
OB-24A	CAA127C1	Retaining Ring , for OB-24 shaft, 1/4" external ring
OB-25	306JG2	Halo used on OB-24 button
OB-26	A385KC1	Button guide and nut for A323BP1
OB-27	306JK1	Button base for A323BP1
OB-27A	6600S80	Mounting bracket for hall pushbutton
OB-27AA		Spring Cup for OB-27A
OB-27B	147JF3-3	Cover plate , stainless steel plate 3" x 10" with one hole 1.180" diameter for OB-24 series
OB-27C	147JF4-3	Cover plate , stainless steel plate 3" x 10" with two holes 1.180" diameter for OB-24 series
OB-27D	147JF3-BR7	Cover plate , bronze, 3" x 10" with one hole 1.180" diameter
OB-27E	147JF4-BR7	Cover plate , bronze, 3" x 10" with two holes 1.180" diameter
OB-28-	323AM1	Button assembly , complete, .98" O.D., 1.14" L, specify marking i.e. OB-28-2
OB-29	A385AV1	Guide , Push button guide
OB-30	A323AF4	Button bottom
OB-31	90YA26	Spring , 25/32" x 1" L, 2 active coils
OB-31A-	323AM	Button , alone, black lexan button top 1" diameter with white markings, specify marking
OB-32-	323AF1	Button assembly , complete, specify marking i.e. OB-32-BLANK
OB-32A-	A323AF	Button , alone, black lexan 7/8" diameter with white markings, specify marking i.e. OB-32A-ARROW
OB-23	MT114289	Swedging tool used to install OB-29 button guide for button assemblies OB-28, OB-32, and OB-50
OB-50-	A323BD2	Button assembly , complete, 1" dia. button with white marking and clear cap, replaces series 323BD, 323AF, 323AM and 323AP. Specify marking, i.e. OB-50-ARROW



Car Signal Components

Pushbuttons

S.E.E.S. #	O.E.M. #	Description
OTBT-1		Button, BR27
OTBT-3		Pushbutton, T-40
OTBT-4		Pushbutton, OTIS 3200
OTBT-5		Button, BR24
OTBT-6		Button, BR27
OTBT-6A		Pushbutton, 24V Otis 2000 brush finished LED Illuminated
OTBT-7		Button, A311
OTBT-7-A313	FAA25090A313	Button, Otis A311 Unpolished SS finish, White Light
OTBT-7-A318	FAA2509A318	Button, Otis A318 Unpolished SS finish, Blue Light
OTBT-8		Push Button, 2V with Red LED Light
OTBT-9		Button, GAK-AB
OTBT-18		Button, Otis Push Button with LED Light
OTBT-VANDAL-RING		Reinforcing Vandal Ring, OTBT Series Push Button
OTLO-2K	XAA431AB1	Key, Triangle
OTPCB-80	B963C2	Pushbutton PCB, Otis B9693C2
OTPCB-80B	B963C3	Pushbutton PCB, Otis B9693C3/B9693C2



OTBT-3



OTBT-4



OTBT-5



OTBT-6



OTBT-6A



OTBT-7



OTBT-8



OTBT-9



OTBT-VANDAL-RING



OTLO-2K



OTPCB-80



OTBT-18

Car Signal Components

Contact Assembly

S.E.E.S. #	O.E.M. #	Description
OB-35	6526G1	Contact assembly
OB-36	150H5	Contact for OB-35 contact assembly
OB-37	150H7	Contact with spring and eyelet for OB-35
OB-38	150H9	Contact with spring, eyelet and guide for OB-35 pushbutton contact assembly



OB-35

Rotodial

S.E.E.S. #	O.E.M. #	Description
OB-39	297F1	Rotodial band, 24 slots
OB-40-	428E1	Rotodial insert, 7/16" x 1", specify marking i.e. OB-40-1
OB-41	443AS1	Rotodial glass, 1-3/8"



OB-36

Jewel

S.E.E.S. #	O.E.M. #	Description
OB-41A-	499AD1	Jewel, 1-9/16" square, white plexiglass with black character, specify marking i.e. OB-41A-ARROW
OB-41B-	499AA1	Jewel, 1-1/8" square with 7/8" diameter round raised face, white with black character, specify marking i.e. OB-41B-1
OB-41C-	499AE1-1	Jewel, 1-1/8" square with 1" diameter round raised face, white with black character, specify marking i.e. OB-41C-2
OB-200	AAA336AAB1	Housing, for Button
OB-201	AAA23500AL78	Jewel, for Button
OB-202	AAA23500AL84	Jewel, Seismic
OB-203	465D2	Sleeve, for Button
OB-204	AAA462HV2	Spacer
OB-205	AAA462HV1	Spacer



OB-37



OB-38



OB-39



OB-40



OB-41



OB-41A



OB-41C



OB-41B



OB-200



OB-201



OB-202



OB-203



OB-204



OB-47



OB-48



OB-49A-1



OB-48A



OB-49



OB-48B

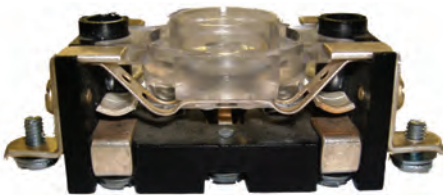

OB-49C



OB-64-ADA



OB-64A-ADA



OB-64B-ADA

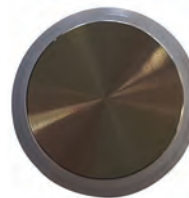

OPB-110



OPB-111



OPB-112



OPB-120

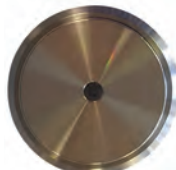

OPB-130



OPB-140

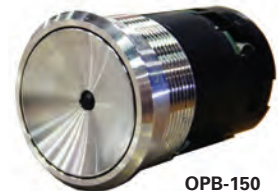

OPB-150

S.E.E.S. #	O.E.M. #	Description
OB-47	306MK1	Halo, locking
OB-48	462GR1	Spacer, felt
OB-48A	323CK1	Button actuator
OB-48B	306MM1	Button base
OB-49	386BNM1	Plate halo, 1-5/16" diameter opening
OB-49A-	250C1	Button insert, black with white markings, 7/8" diameter, specify marking, i.e. OB-49A-1
OB-49C	PB1-0227N	Button Switch, 2 N.O. 2 N.C. 120V with lamp, 177BS2
OB-49D		Button Switch, 2 N.O. 2 N.C. 28V
OB-64-ADA	323AD5	Target, White Raised LRV ADA Style
OB-64A-ADA	323AD6	Target, Green Raised LRV ADA Style
OB-64B-ADA	323AD7	Target, Yellow Raised LRV ADA Style
OPB-110	AAA23500CH5	Pushbutton, 24 VDC SS SS4, Flat Projecting, Red LED
OPB-110-G	AAA23500CH110	Pushbutton, 24 VDC SS SS4, Flat Projecting, Green LED
OPB-111	AAA23500CH16	Pushbutton, SS4, Flat Projecting, Non-Illuminating
OPB-112	AAA23500CH73	Pushbutton, White Plastic, California 24V, MMIII
OPB-120	AAA235000AM2	Pushbutton, 24 VDC SS Red LED, Micro Mot III, Flat Projecting
OPB-120A	FAA72N1	Retaining Nut for OPB-120
OPB-130	AAA23500AM5	Pushbutton, 24 VDC SS Non Illum with Micro Mot III, Flat Projecting
OPB-140	AAA23500AM9	Pushbutton, 6 VDC SS Red Led with Screw Conn, Concave Flush
OPB-150	AAA23500BZ18	Pushbutton, 6VDC SS Red Led Vandal Resist, Concave Flush

For complete button assembly order one each of the above items and specify marking required.

Car Signal Components

Switches

S.E.E.S. #	O.E.M. #	Description
OPB-1	7035A8	Switch, Single (making-breaking) contact
OPB-2	7035A9	Switch, Single (making) contact
OPB-4	7035A11	Switch, Double (making) contact
OPB-5	7035A10	Switch, Double (making-breaking) contact
OPB-6	7035A28	Switch, Single (making) contact with lamp assembly
OPB-7	7035A12	Switch, Single (make-break) contact, with plastic button 3/4" diameter x 3/4" long
OPB-8	7035A14	Switch, Single (make-break) contact with plastic button 3/4" diameter x 3/8" long
OTSW-2R	TAA177AH2	Switch, TAA177AH2
OTSW-12	XAA177H2	Switch, Limit
OTSW-13		Switch, Limit
OTSW-14	J06098E5	Switch, 6098 Mechanical
OTSW-15	XAA177BE1	Silicon Controller
OTSW-16		Switch, SDK 716-1 Combined
OTSW-17		Switch, SDK 716-2 Combined
OTSW-18		Switch, SDK 716-3 Combined
OTSW-19		Switch, SDK 716-3 Combined
OTSW-20		Switch, SDK-740 40A Host Command
OTSW-21		Switch, for Landing Door PB78
OTSW-22		Switch, Limit LX-028
OTSW-24L	TAA177AH1	Switch, TAA177AH1
OTSW-24R	TAA177AH2	Switch, TAA177AH2
OTSW-25		Contact, Otis
OTSW-24L	TAA177AH1	Switch, TAA177AH1



OPB-1



OPB-2



OPB-4



OPB-5



OTSW-12



OPB-6



OPB-7



OPB-8



OTSW-13



OTSW-16



OTSW-24L



OTSW-25

Car Signal Components



OB-9A



OB-10



OB-11



OB-11C



OB-11A

S.E.E.S. # Description

OB-9	Direction indicator panel , stainless steel plate 1/8" x 3-3/8" x 10", with one triangular cutout for up or down arrows
OB-9A	Direction indicator panel , as above but with two triangular cutouts for up and down arrows (shown)
OB-10	Direction indicator , white frosted arrow 2-3/8" with red plastic back plate, 2-5/8" square
OB-11	Direction indicator , white frosted arrow 2-3/8" with green plastic back plate, 2-5/8" square
OB-11B	Direction indicator , 2" frosted arrow on clear backing plate, 2-1/4" wide x 2" high
OB-11C	Direction indicator , 2" frosted arrow on red backing plate, 2-1/4" wide x 2" high
OB-11A	Direction indicator , with clear arrow 2-3/8" on backing plate, 2-5/8" square white markings, 5/16" I.D., 1/4" thick, specify marking i.e. OB-6-LIGHT OFF ON

Digital Displays

S.E.E.S. # O.E.M. # Description

OTIDS-13	XBA23550B1	Digital Display , Otis Twin
-----------------	------------	------------------------------------



OB-42



OB-42B



OB-44



OB-44A

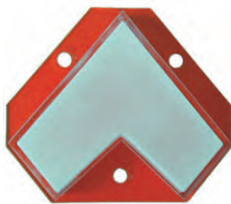

OB-43A



OB-5



OB-6

S.E.E.S. # O.E.M. # Description

OB-42	449AA2	Jewel , Hall lantern, white arrow on red
OB-42A	449AA3	Jewel , Hall lantern, white arrow on white
OB-42B	449AA1	Jewel , Hall lantern, white arrow on green
OB-43	449AM3	Chevron arrow , white on clear plate
OB-43A	449AM2	Chevron arrow , white on red plate
OB-43B	449BA	Lens , Round
OB-43C	A449AS	Lens , Triangle
OB-44	449BB3	Lens cover , Position indicator, black "up" arrow on white molded plastic
OB-44A	449BB2	Lens cover , Position indicator, black "down" arrow on white molded plastic
OB-5-	340AA2, 340AA3	Indicator ring , 1" O.D., black or red with white markings, 1/2" I.D., 3/16" thick specify marking i.e. OB-5-OFF-ON-EMERG.
OB-6-	329J4	Indicator ring , 3/4" O.D., black with white markings, 5/16" I.D., 1/4" thick, specify marking i.e. OB-6-LIGHT OFF ON

Car Signal Components



Emergency Stop Switches

S.E.E.S. #	O.E.M. #	Description
OSS-1	A7014B1	Button, 1" diameter without collar
OSS-2	A7014B5	Button, 1" diameter with collar
OSS-3	GS17014B1	Button, 3/4" diameter for GS17014A1
OSS-4	GS17014B2	Button, 3/4" diameter with spring
OSS-6	7014A9	Switch, with 1" dia. red phenolic button with collar and auxiliary contact marked "PUSH TO STOP/PULL TO RUN", 2 N.C., 1 N.O.
OSS-7	7014A1	Switch, without collar, with auxiliary contact marked "PUSH TO STOP/PULL TO RUN" with red phenolic button 1" diameter
OSS-8	7014A2	Switch, without collar, or auxiliary contact marked "PUSH TO STOP/PULL TO RUN" with red phenolic button 1" diameter
OSS-9	7014A10	Switch, with 1" dia. red phenolic button and collar without auxiliary contact marked "PUSH TO STOP/PULL TO RUN"
OSS-10	GS17014A1	Switch, with auxiliary contact, with red phenolic button 3/4" dia.
OSS-11	GS17014A2	Switch, without auxiliary contact, with red phenolic button 3/4" dia.



OSS-6



OSS-7



OSS-8



OSS-5



OSS-14



OSS-15



OSS-9



OSS-10

Emergency Stop Switch Components

S.E.E.S. #	O.E.M. #	Description
OSS-5	6800DJ1	Mounting base
OSS-14	94AA1	Spring
OSS-15	323BR1	Button collar
OSS-16	150AY2	Stationary contact
OSS-17	150R12	Movable contact
OSS-20	90FE2	Compression spring for collar



OSS-16



OSS-17



OSS-20

Car Signal Components

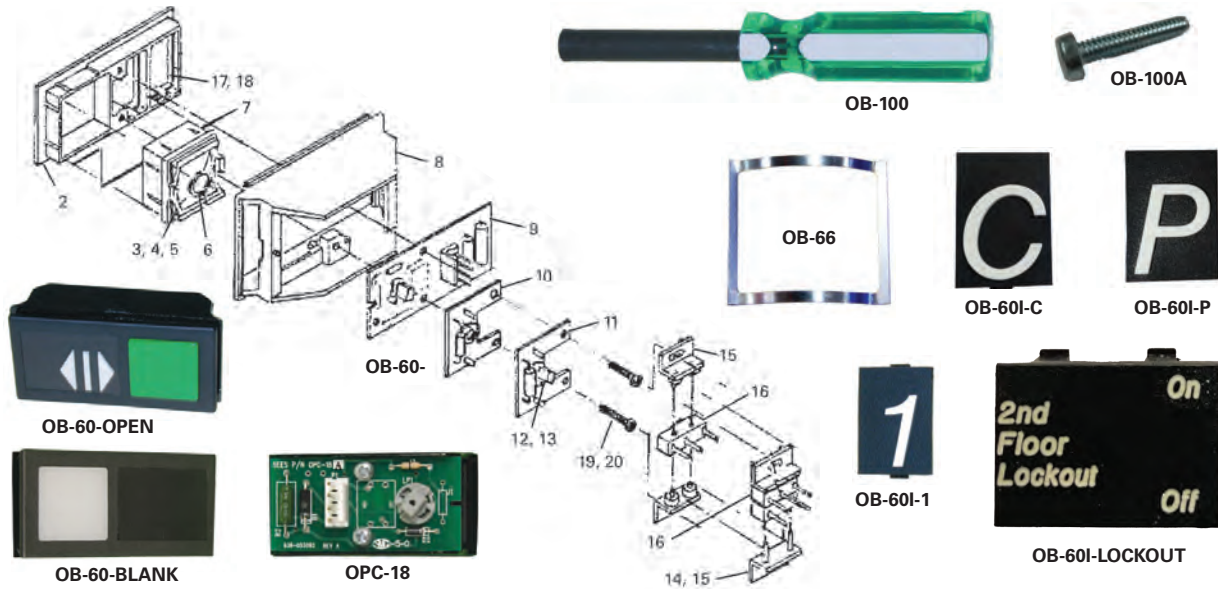

Button Module

Fig. S.E.E.S. #	O.E.M. #	Description
1	OB-60-	7069AF- Pushbutton module (specify marking, and required PC board or microswitch(es))
	OB-60-DOWN_W/OPC-20	Button Module , "Down Arrow" With OPC-20 Pcb
	OB-60-UP_W/_OPC-18	Button Module , "UP ARROW" PCB (Hall) 28V
	OB-60-UP_W/_OPC-20	Button Module , "Up Arrow" with OPC-20 Pcb
	OB-60I-LOCKOUT	Lrv Insert , "2nd Floor Lockout" "On , Off"
2	OB-61	396BP1 Chicklet , 2-3/4" L x 1-3/8" H
	OB-61-BLANK	396LB1 Chicklet , blank frame for LRV
3	OB-64	323DA1 Target , white
4	OB-64A	323DA2 Target , green
5	OB-64B	323DA3 Target , yellow
6	OB-65	278EA1 Reflector
7	OB-66	94FA1 Button spring , S/S, 61/64
8	OB-67	396VB1 Housing
9	OPC-18	8200KA1 PC Board , Button Board with 28V, #85 lamp & socket (hall)
	OPC-18A	8200KA2 PC Board , Button Board w/ 28V, #85 lamp & socket (car)
	OPC-18B	8200KA3 PC Board , Button Board with 28V, orange LED & socket (hall)
	OPC-18C	A26800PZ1 PC Board , button board with white LED and socket (car)
	OPC-18D	A26800PZ2 PC Board , for hall, orange LED, 2 button
10	OPC-20	8200AL3 Neon Lamp PC Board with 120V neon lamp
11	OPC-19	8200AL1 Lamp PC Board with 28V #85 lamp and socket

Fig. S.E.E.S. #	O.E.M. #	Description
12	OB-62	467AT1 Socket , #85 for 28V lamp
13	ML-108	424R1 Lamp , #85 for 28V, .04 amps,
	ML-108-LED-O	AAA629AY3 Lamp , orange LED replacement for #85 lamp
14	OB-68	180DA1 Double switch holder , 2 pins, 15/64" L
15	OB-69	180DA2 Single switch holder , 2 pins, 1/8" L
16	OB-70	177DA1 Microswitch , 5 Amps, 125/250 VAC
17	OB-60I-	250D-- Single graphic insert , 21/32" L x 15/16" H, (specify marking)
18	OB-60I-	250E-- Double graphic insert , 1-5/16" L x 15/16" H, (specify marking)
	OB-60I-C	250D12 LRV INSERT "C"
	OB-60I-P	396LB1 LRV INSERT "P"
	OB-60I-FIRE-RESET	Insert , for Keyswitch Fire Reset
19	OB-66A	124CY2 Pan head screw , Plastite, 1/2" L
20	OB-66B	124CY4 Pan head screw , Plastite, 3/4" L

S.E.E.S. #	O.E.M. #	Description
OB-100	MT-105024	Tool , manual driver for security fasteners used on LRV car panels
OB-100A		Security Screw , LRV Car Panel screw used with OB-100
OB-60-BLANK-W/OPC-18B		PB Assy Module , Blank for Hall with OPC-18B, Orange LED
OB-60-BLANK-W/OPC-18C		PB Assy Module , Blank for Car with OPC-18C, White LED

International symbols are now being supplied for some markings Available in Vandal Proof as Special Order.

Car Signal Components

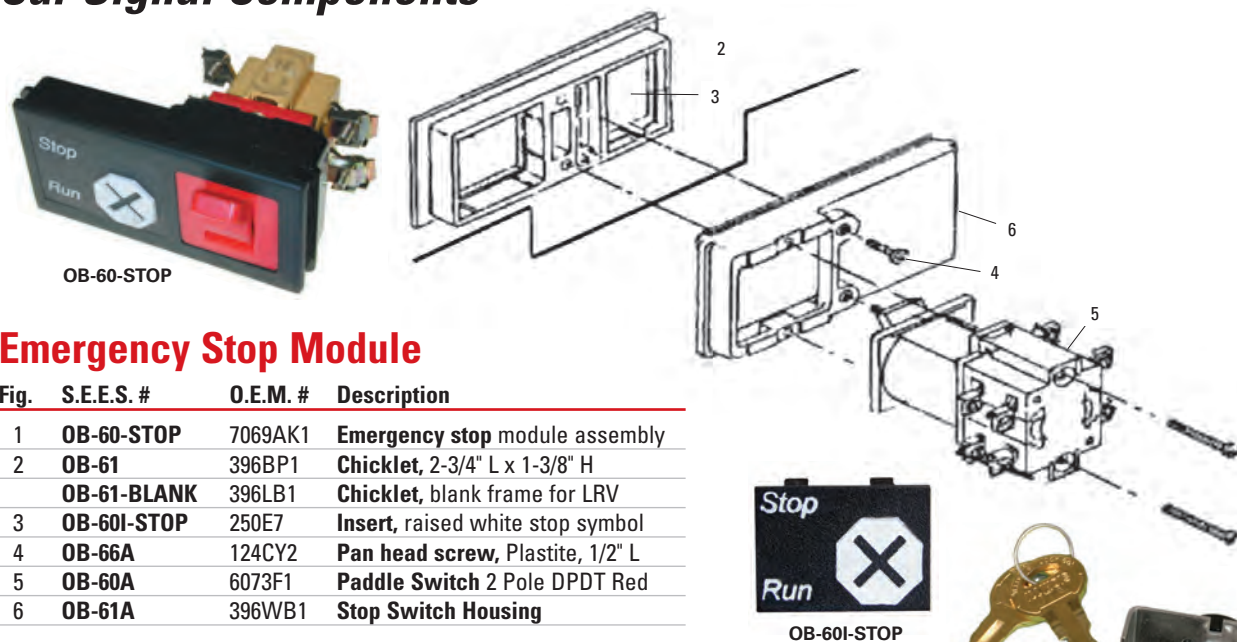

Emergency Stop Module

Fig.	S.E.E.S. #	O.E.M. #	Description
1	OB-60-STOP	7069AK1	Emergency stop module assembly
2	OB-61	396BP1	Chicklet, 2-3/4" L x 1-3/8" H
	OB-61-BLANK	396LB1	Chicklet, blank frame for LRV
3	OB-60I-STOP	250E7	Insert, raised white stop symbol
4	OB-66A	124CY2	Pan head screw, Plastite, 1/2" L
5	OB-60A	6073F1	Paddle Switch 2 Pole DPDT Red
6	OB-61A	396WB1	Stop Switch Housing

Emergency Stop Key Switch

S.E.E.S. #	O.E.M. #	Description
OB-60K	7069AH60	Key Switch Module, "STOP-RUN", remove 2 position, with UTA key
OB-60K-A03		Key Switch Assembly, Run-Stop 2 Pos, A03 Key
OB-60K-UTC		Key Switch Assembly, Run-Stop 2 Pos, Rmv 2 UTC Key

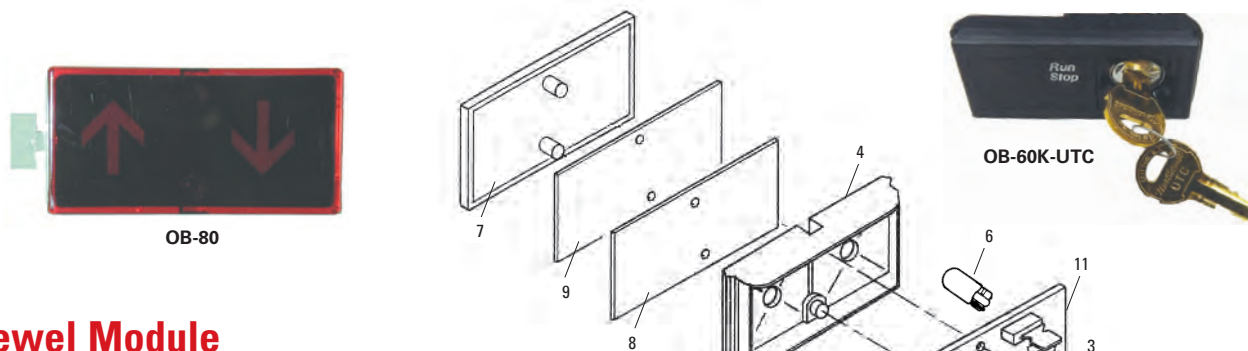

Jewel Module

Fig.	S.E.E.S. #	O.E.M. #	Description
1	OB-80-	7069AG-	Jewel module assembly, (specify marking)
2	OB-71A	P614AS1	Connector, 3-circuit, 18 AWG
	OB-71	P164AS2	Connector, 4-circuit
3	OB-66B	124CY4	Pan head screw, Plastite, 18 mm
4, 5	OB-81	278FA1, A2	Jewel reflector, with shield, white, 2-55/64" x 1-23/24"
6	ML-108	424R1	Lamp, incandescent, wedge base, 28V
7	OB-63A	443CB1	Lens, red, 2-3/4" x 1-3/8"
	OB-63	443CH1	Lens, green, 8-1/2" x 8"
	OB-63C		Lens, clear, 2-3/4" x 1-3/8"
8	OB-83	443CP1	Lens spacer, for flat fixtures, clear
9	OB-80I-	449BJ3	Mask, (specify marking)
10	OB-62	467AT1	Lamp socket, Type 85
11	OPC-17	8200JA1	P.C. Board with lamps and sockets
	OB-84	AAA23851B22	Emerg. Light Indicator, Round Red Lamp and Holder



Car Signal Components

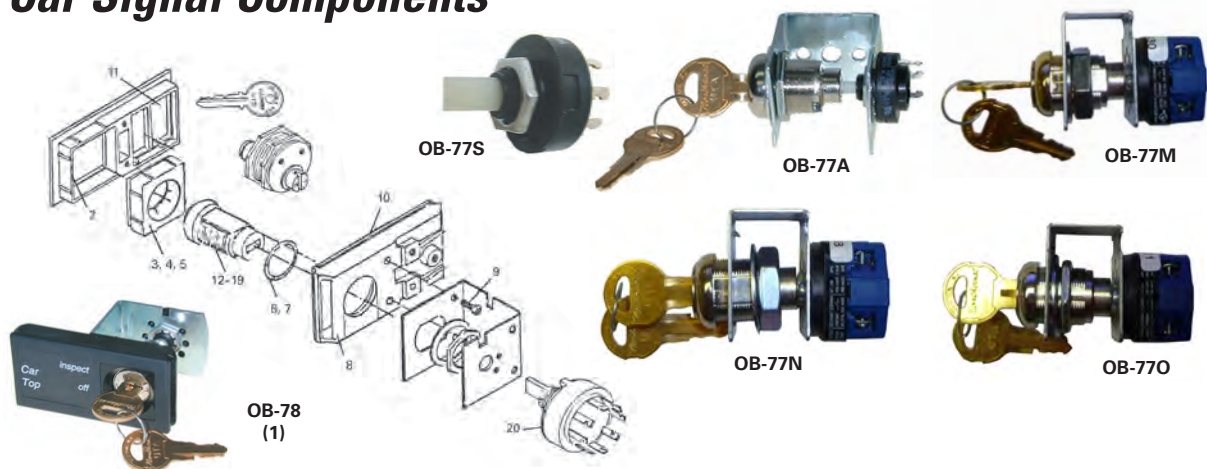

Keyswitches

Fig.	S.E.E.S. #	O.E.M. #	Description
1	OB-78	7069AH33	Keyswitch module , Inspection Initiation, UTA
	OB-78A	7069AH34	Keyswitch module , Independent Service
	OB-78B	7069AH35	Keyswitch module , Hospital Service
	OB-78C	7069AH36	Keyswitch module , SES Phase II ANSI
	OB-78D	7069AH42	Keyswitch module , fan, 2-speed
	OB-78F	7069AH58	Keyswitch module , Fire Service, 3 Pos ON/OFF/HOLD
	OB-78F-255	7069AH58-255	Keyswitch module , LRV PH2 3P/R2, Off-Hold-On, 255 Key
	OB-78F-2642	7069AH58-2642	Keyswitch module , LRV PH2 3P/R2
	OB-78F-3502	7069AH58-3502	Keyswitch module , LRV PH2 3P/R2, Off-Hold-On, 3502
	OB-78G	7069AH48	Keyswitch module , Fire Service, 3 Pos ON/OFF/BYPASS
	OB-78G-255	7069AH58-2642	Keyswitch module , LRV PH1 3P/R2, Byp-Off-On, 255 Key
	OB-78G-2642	7069AH48-2642	Keyswitch module , LRV PH1 3P/R2 Byp-Off-On, 2642
	OB-78G-3502	7069AH48-3502	Keyswitch module , LRV PH1 3P/R2, Byp-Off-On, 3502
	OB-78G-3502R	7069AH48-3502	Keyswitch module , LRV PH1 3P/R2, Reset-Off-On, 3502 Reset
	OB-77H-255		Keyswitch module , PH 1 255 Key, 3 Pos, Rmv 2
	OB-78H	7069AH21	Keyswitch module , 2 Pos LIGHT OFF/ON
	OB-77J-255		Keyswitch , PH 2 255 Key, 3 Pos, Rmv 2
	OB-78K-UTC		Keyswitch module , 2 Pos, Rmv 2, UTC Key 2nd Floor Lockout
	OB-78L		Keyswitch module , Blank 2P/R2 A03
	OB-78L-UTB		Keyswitch module , Blank 2 Pos, Rmv 2, UTB Key
	OB-78-A03		Key Switch Assembly , Inspection with A03 Key
	OB-78-SPECIAL		Key Switch , Specify Key
2	OB-61	396PB1	Chicklet , color black, 2-3/4" L x 1-3/8" H
3	OB-72	396XB1	Mount , color blue
4	OB-72A	396XB2	Mount , color red
5	OB-72B	396XB3	Mount , color black
6	OB-73	182H7	O-ring , 35/64" I.D.
7	OB-73A	182H8	O-ring , 47/64" I.D.
8	OB-74-	396KC1	Keyswitch housing , black
9	OB-75	124CY1	Pan head screw , self-tapping
10	OB-76	316DMD2	Bracket , maintaining, double-keyed cutout
11	OB-60I-	250E--	Double graphic insert , 1-5/16" L, 15/16" H, (specify marking)
12	OB-77A	6410W23	Keyswitch assembly , removed at CTR-CW, key 6410W-UTA (includes A, B, & C)
13	OB-77B	6410W24	Keyswitch assembly , removed at CTR-CW, key 6410W-UTD (includes A, B, & C)
14	OB-77C	6410W25	Keyswitch assembly , 2 Pos, removed at CTR, key 6410W-UTF (includes A, B, & C)
15	OB-77D	6410W27	Keyswitch assembly , removed at CCW-CTR-CW, key 6410W-UTA (includes A, B, & C)
16	OB-77E	6410W28	Keyswitch assembly , removed at CCW-CTR-CW, key 6410W-UTA (includes A, B, & C)
17	OB-77F	6410W1	Keyswitch assembly , 2 Pos, spring return to CTR off, key J200 (includes A, B, & C)

Car Signal Components

Keys and Keyswitches

S.E.E.S. #	O.E.M. #	Description
OB-46	VP79605	Key "GA"
OB-46A	VP79705	Key "GB"
OB-77F-A		Keyswitch, 2 Position, Remove 1, J200 Key
OB-77F-B		Keyswitch, 2 Position, Remove 2, J200 Key
OB-77G	6410W30	Keyswitch assembly, 3 Pos removed at CCW-CTR-CW, key 6410W-UTF (incl. A, B, & C)
OB-77H6410W7		Keyswitch assembly, 3 Pos, removed at CTR-CW, key 6410W-UTF (incl. A, B, & C)
OB-77K		Keyswitch assembly, GA Key, 3 Pos Rem 1 Spring Return To Center
OB-77M	ABA6410AB30	Keyswitch assembly, 3 Pos Sprg Return Rmv At Center, DPDT, UTA Key
OB-77M-UTH		Keyswitch assembly, KeySw Assy, 3 Pos Sprg Return, MOM Rmv At Center, UTH Key
OB-77N	ABA6410AB11	Keyswitch assembly, 2 Pos Rmv 1 UTF Key DPST
OB-77O	ABA6410AB8	Keyswitch assembly, 2 Pos Rmv 1 UTF Key DPST
OB-77S	177CC5	Switch, 3 Pos, 8 pin, 2 pole
DKOB-001R	H2389	Key Switch, Ph1 Reset-Off-On 3 Pos, Rmv 2
OB-77-255		Key, 255
OB-77-BGM30		Key, BGM30
OB-77T	ABA636A9	Switch, 2 Pos, NC DPST
OB-77U	ABA636A10	Switch, 2 Pos, NO DPST
OB-77V	ABA636A11	Switch, 3 Pos, Spring Return to Center, NO, DPDT
OB-77-UTA	6410WUTA	Key, UTA, light, fan, independent service inspection enable
OB-77-UTB	6410WUTB	Key, UTB, light, fan
OB-77-UTC	6410WUTC	Key, UTC, floor, lockout, attendant service
OB-77-UTD	6410WUTD	Key, UTD, floor lockout, main lockout key
OB-77-UTE	6410WUTE	Key, UTE, priority service
OB-77-UTF	6410WUTF	Key, UTF, fire service, emergency power OP
OB-77-UTG	6410WUTG	Key, UTG, floor lockout
OB-77-UTH	6410WUTH	Key, UTH, floor lockout, inspection/access
OB-77F-UTA	6410W1	Keyswitch Spring Return with UTA Key
OB-77F-UTC	6410W1UTC	Keyswitch assembly, 2 Pos, MOM R1, UTC key
OB-77F-UTD	6410W1UTD	Keyswitch assembly, 2 Pos, spring return to CTR off, UTD key
OKS-1	6410R2	Key Switch for light switch
OSS-18		Key for light switch, long style



OB-77F-A



OB-46



OB-77F-B



OB-77M-UTH



OB-77H-255



OB-77J-255



OKS-1



OB-77J-UTD



OB-77J-UTF



OB-77F-UTD



OB-77-BGM30



OB-77-UTD



OB-77F-UTA



OB-77F-UTC

Car Signal Components



OB-77K-UTC



OB-77P-UTB



OB-207



OB-208

OB-209



OB-51A



OB-206

Keys and Keyswitches

S.E.E.S. #	O.E.M. #	Description
OB-77J-UTD	6410WUTH	Keyswitch, 2 Pos, Rmv 2 with UTD key
OB-77J-UTF		Keyswitch, Ph II 3Pos, Rmv 2 UTF Key
OB-77L-UTA		Keyswitch assembly, 2 Pos, Rmv 2 w/ UTA key
OB-77K-UTC	6410WUTH	Keyswitch, 2 Pos, Rmv 2 with UTC key
OB-77K-UP-OFF-DN		Keyswitch, GA Key, with 1-3/4" Black Bezel 3 Pos Rem 1, Momentary, Up-Off-Down
OB-77M-UTE		Keyswitch assembly, 3 Pos Sprg Return Rmv At Center, DPDT, UTE Key
OB-77P-UTH		Keyswitch, 2 Position, UTH Key
OB-77P-UTG		Keyswitch, 2 Position, UTG Key
OB-77P-UTB		Keyswitch, 2 Position, UTB Key
OB-207	ABA23500F30	Stop Key Switch, Emergency
OB-208	AAA23851A130	Keyswitch, FEO Phase II
OB-209	ABA23500G206	Keyswitch, Independent Service
OB-210	ABA23500G293	Keyswitch Assembly
OB-211		Keyswitch, M3 "Access" UTE Key Up-Off-Down 3 Pos Momentary
OSS-KS-001	O471K1	Keyswitch, 2 N.C. OSS Replacement

Single Stroke Gongs

S.E.E.S. #	O.E.M. #	Resistance	Description/Gong Application
OB-51A**	311B1	840. ohms	Gong, Across the line, 115 VAC
OB-51B*	311B2	32. ohms	Gong, In series with 25 watt lamp, 115 VAC
OB-51C*	311B3	14. ohms	Gong, In series with 40 watt lamp or two 25 watt lamps in parallel, 115 VAC
OB-51**	311B4	2130. ohms	Gong, Across the line, 115 VDC
OB-51D*	311B5	18. ohms	Gong, In series with 25 watt lamp, 120 VAC
OB-51E*	311B6	50. ohms	Gong, In series with 40 watt lamp or two 25 watt lamps in parallel, 115 VDC

* Used with incandescent lamps only (not lumiline) ** For fluorescent or lumiline lamps

Gong Parts

S.E.E.S. #	O.E.M. #	Description
OB-206	AAA08200AAA002	PCB, Gong Assembly

Coils



OC-1 thru OC-3

27/32" I.D. x 1-15/16" O.D. x 1-7/8" L

S.E.E.S. #	O.E.M. #	Resistance
OC-1	222CC1	21 Ohms
OC-2	222CC2	25 Ohms
OC-3	222CC3	35 Ohms



OC-4 thru OC-8

25/32" I.D. x 1-5/8" O.D. x 1-7/8" L

S.E.E.S. #	O.E.M. #	Resistance
OC-4	222CD1	1690 Ohms
OC-5	222CD2	1118 Ohms
OC-6	222CD3	242 Ohms
OC-7	222CD4	455 Ohms
OC-8	222CD5	119 Ohms



OC-9 thru OC-16

1-1/32" I.D. x 2" O.D. x 2-15/32" L

S.E.E.S. #	O.E.M. #	Resistance
OC-9	222CV1	1410 Ohms
OC-11	222CV3	900 Ohms
OC-12	222CV4	375 Ohms
OC-13	222CV5	900 Ohms
OC-14	222CV6	375 Ohms
OC-15	222CV7	2230 Ohms
OC-16	222CV8	155 Ohms



OC-17, OC-18

21/32" I.D. x 1-13/32" O.D. x 1-15/32" L

S.E.E.S. #	O.E.M. #	Resistance
OC-17	222CX1	X=3233 Ohms Y=162 Ohms
OC-18	222CX2	X=1753 Ohms Y=1649 Ohms

■ X=Inner winding resistance.
Y=Outer winding resistance.



OC-19 thru OC-29

21/32" I.D. x 1-13/32" O.D. x 1-15/32" L

S.E.E.S. #	O.E.M. #	Resistance
OC-19	222CY1	3384 Ohms
OC-20	222CY2	1488 Ohms
OC-21	222CY3	213 Ohms
OC-22	222CY4	49 Ohms
OC-23	222CY5	9 Ohms
OC-24	222CY6	0.1 Ohms
OC-25	222CY7	870 Ohms
OC-26	222CY8	2 Ohms
OC-27	222CY9	116 Ohms
OC-28	222CY10	386 Ohms
OC-29	222CY11	1110 Ohms



OC-30 thru OC-35

21/32" I.D. x 1-13/32" O.D. x 1-15/32" L

S.E.E.S. #	O.E.M. #	Resistance
OC-30	222CZ1	X=1753 Ohms Y=1649 Ohms
OC-31	222CZ2	X=968 Ohms Y=509 Ohms
OC-32	222CZ3	X=3233 Ohms Y=162 Ohms
OC-33	222CZ4	X=1075 Ohms Y=0.31 Ohms
OC-34	222CZ5	X=634 Ohms Y=821 Ohms
OC-35	222CZ6	X=0.73 Ohms Y=1475 Ohms



OC-36 thru OC-37

1-13/32" I.D. x 3-1/16" O.D. x 2-23/32" L

S.E.E.S. #	O.E.M. #	Resistance
OC-36	222CM1	806 Ohms
OC-37	222CM2	204 Ohms



OC-39

1-1/32" I.D. x 2" O.D. x 2-15/32" L

S.E.E.S.#	O.E.M. #	Resistance
OC-39	222DE1	X=477 Ohms Y=108 Ohms

■ X=Inner winding resistance.
Y=Outer winding resistance.

Coils



OC-40 thru OC-58



OC-59 thru OC-65



OC-66F thru OC-77

9/16" I.D. x 1-5/16" O.D. x 1-21/64" L
S.E.E.S. # O.E.M. # Resistance

OC-40	222E14	9	Ohms
OC-41	222E15	12	Ohms
OC-42	222E16	13	Ohms
OC-43	222E17	18	Ohms
OC-44	222E18	21	Ohms
OC-45	222E19	29	Ohms
OC-46	222E20	34	Ohms
OC-47	222E21	47	Ohms
OC-48	222E22	54	Ohms
OC-49	222E23	73	Ohms
OC-50	222E24	83	Ohms
OC-51	222E25	113	Ohms
OC-52	222E26	129	Ohms
OC-53	222E27	177	Ohms
OC-54	222E28	204	Ohms
OC-55	222E29	278	Ohms
OC-56	222E30	320	Ohms
OC-57	222E31	437	Ohms
OC-58	222E32	500	Ohms

29/32" I.D. x 1-3/4" O.D. x 1-27/32" L
S.E.E.S. # O.E.M. # Resistance

OC-59	222EB1	1860	Ohms
OC-60	222EB2	1230	Ohms
OC-61	222EB3	820	Ohms
OC-62	222EB4	495	Ohms
OC-63	222EB5	316	Ohms
OC-64	222EB6	201	Ohms
OC-65	222EB7	129	Ohms

27/32" I.D. x 1-5/16" O.D. x 2-3/64" L
S.E.E.S. # O.E.M. # Resistance

OC-66F	222F1	2	Ohms
OC-66A	222F2	3	Ohms
OC-66B	222F3	5	Ohms
OC-66C	222F4	8	Ohms
OC-66D	222F5	13	Ohms
OC-66E	222F6	20	Ohms
OC-66	222F7	31	Ohms
OC-67	222F8	51	Ohms
OC-68	222F9	80	Ohms
OC-69	222F10	119	Ohms
OC-70	222F11	196	Ohms
OC-71	222F12	310	Ohms
OC-72	222F13	476	Ohms
OC-73	222F14	745	Ohms
OC-74	222F15	1210	Ohms
OC-74A	222F16	1882	Ohms
OC-75	222F17	2885	Ohms
OC-76	222F18	4570	Ohms
OC-77	222F19	6760	Ohms

Coils

41/64" I.D. x 1-3/32" O.D. x 1-15/16" L
S.E.E.S. # O.E.M. # Resistance

OC-78	222FF1	3397	Ohms
OC-79	222FF2	923	Ohms
OC-80	222FF3	348	Ohms
OC-81	222FF4	258	Ohms
OC-82	222FF5	200	Ohms
OC-83	222FF6	16	Ohms
OC-84	222FF7	3163	Ohms
OC-85	222FF8	796	Ohms
OC-86	222FF9	1849	Ohms
OC-87	222FF10	805	Ohms
OC-88	222FF11	194	Ohms
OC-89	222FF12	394	Ohms
OC-90	222FF13	12	Ohms

27/32" I.D. x 2-7/16" O.D. x 1-19/32" L
S.E.E.S. # O.E.M. # Resistance

OC-90A	222FG1	980	Ohms
OC-90B	222FG2	404	Ohms

1-1/16" I.D. x 2-1/4" O.D. x 4-5/16" L
S.E.E.S. # O.E.M. # Resistance

OC-90C	222FN1	X=83	Ohms
		Y=22	Ohms

27/32" I.D. x 1-15/16" O.D. x 1-3/32" L
S.E.E.S. # O.E.M. # Resistance

OC-99	222G14	16	Ohms
OC-99A	222G1	0.8	Ohms
OC-99B	222G2	1	Ohms
OC-99F	222G6	2.6	Ohms
OC-99G	222G7	3.5	Ohms
OC-99J	222G10	7	Ohms
OC-99K	222G11	9	Ohms
OC-99M	222G13	14	Ohms
OC-100	222G15	21	Ohms
OC-101	222G16	25	Ohms
OC-102	222G17	35	Ohms
OC-103	222G18	42	Ohms
OC-104	222G19	55	Ohms
OC-105	222G20	65	Ohms
OC-106	222G21	86	Ohms
OC-107	222G22	100	Ohms
OC-108	222G23	135	Ohms
OC-109	222G24	160	Ohms
OC-110	222G27	336	Ohms
OC-111	222G31	826	Ohms

41/64" I.D. x 1-3/32" O.D. x 1-15/16" L
S.E.E.S. # O.E.M. # Resistance

OC-91	222FD1	X=16	Ohms
		Y=2820	Ohms
OC-92	222FD2	X=1434	Ohms
		Y=1268	Ohms
OC-93	222FD3	X=656	Ohms
		Y=464	Ohms
OC-94	222FD4	X=392	Ohms
		Y=2800	Ohms
OC-95	222FD5	X=470	Ohms
		Y=815	Ohms
OC-96	222FD6	X=1240	Ohms
		Y=1640	Ohms
OC-97	222FD7	X=575	Ohms
		Y=1513	Ohms
OC-98	222FD8	X=177	Ohms
		Y=1915	Ohms

X=Inner winding resistance.
Y=Outer winding resistance.



OC-78 thru OC-90

Used in Type 7055C Pile up Contact.
X=Inner winding resistance.
Y=Outer winding resistance.



OC-91 thru OC-98

Used in Type 7055C Pile up
X=Inner winding resistance.
Y=Outer winding resistance.



OC-90A



OC-90B



OC-90C



OC-99A thru OC-111

X=Inner winding resistance.
Y=Outer winding resistance.

Coils

■ X=Inner winding resistance.
Y=Outer winding resistance.



OC-112 thru OC-115A

9/16" I.D. x O.D. 1-5/16" x 1-7/16" L

S.E.E.S. # O.E.M. # Resistance

OC-112	222T4	X=238	Ohms	Y=57	Ohms
OC-113	222T5	X=1480	Ohms	Y=369	Ohms
OC-114	222T8	X=1130	Ohms	Y=307	Ohms
OC-115	222T10	X=307	Ohms	Y=3	Ohms
OC-115A	222T15	X=10	Ohms	Y=510	Ohms



OC-116 thru OC-124

■ X=Inner winding resistance.
Y=Outer winding resistance.

9/16" I.D. x O.D. 1-5/16" x 1-7/16" L

S.E.E.S. # O.E.M. # Resistance

OC-116	222Z1	X=948	Ohms	Y=380	Ohms
OC-117	222Z2	X=1450	Ohms	Y=1875	Ohms
OC-118	222Z3	X=715	Ohms	Y=109	Ohms
OC-119	222Z4	X=491	Ohms	Y=31	Ohms
OC-120	222Z5	X=1880	Ohms	Y=140	Ohms
OC-121	222Z6	X=1880	Ohms	Y=72	Ohms
OC-122	222Z7	X=830	Ohms	Y=1190	Ohms
OC-123	222Z8	X=1270	Ohms	Y=58	Ohms
OC-124	222Z9	X=1200	Ohms	Y=4	Ohms



OC-125 thru OC-143

■ X=Inner winding resistance.
Y=Outer winding resistance.

9/16" I.D. x 1-5/16" O.D. x 1-7/16" L

S.E.E.S. # O.E.M. # Resistance

OC-125	222W1	0.6	Ohms		
OC-126	222W2	0.9	Ohms		
OC-127	222W3	1	Ohms		
OC-128	222W4	2	Ohms		
OC-129	222W5	4	Ohms		
OC-130	222W6	6	Ohms		
OC-131	222W7	9	Ohms		
OC-132	222W8	14	Ohms		
OC-133	222W9	23	Ohms		
OC-134	222W10	36	Ohms		
OC-134A	222W11	55	Ohms		
OC-135	222W12	90	Ohms		
OC-136	222W13	135	Ohms		
OC-137	222W14	209	Ohms		
OC-138	222W15	337	Ohms		
OC-139	222W16	539	Ohms		
OC-140	222W17	826	Ohms		
OC-141	222W18	1329	Ohms		
OC-142	222W19	2070	Ohms		
OC-143	222W20	3325	Ohms		

Coils



Fig.	S.E.E.S. #	O.E.M. #	Resistance
1	OC-145A	118193	236 Ohms
2	OC-145B	136224	X=20 Ohms Y=75 Ohms
1	OC-145C	137907	158 Ohms
6	OC-145	177296	2760 Ohms
3	OC-146	177297	600 Ohms
5	OC-148	178720	472 Ohms
3	OC-149	178721	66 Ohms
6	OC-150	180713	64 Ohms
3	OC-151	182356	119 Ohms
3	OC-152	182357	260 Ohms
3	OC-153	182726	290 Ohms
7	OC-154	182731	560 Ohms
5	OC-187	183887	605 Ohms
6	OC-153A	183915	90 Ohms
6	OC-153B	183919	14 Ohms
7	OC-188	183920	1865 Ohms
2	OC-188A	183935	X=75 Ohms Y=140 Ohms
5	OC-188B	183973	50 Ohms
4	OC-188C	183978	235 Ohms

■ X=Inner winding resistance.
Y=Outer winding resistance.

S.E.E.S. #	O.E.M. #	Resistance	Description
OC-147	177299A	565 Ohms	Flat bobbin type coil 3/8" I.D., 1-5/8" O.D., 13/16" L
OC-185	177299	700 Ohms	Paper section type coil 5/8" I.D., 1-1/8" O.D., 2-1/4" L

S.E.E.S. #	O.E.M. #	Description
OC-220	146406	Phase Splitter Coil



Coils



OC-155 thru OC-171, OC-177A & OC-177B



OC-172A thru OC-178



OC-179A thru OC-184A

13/16" I.D. x 1-7/8" O.D. x 1-3/4" L
S.E.E.S. # O.E.M. # Resistance

OC-177A	103586	1.2	Ohms
OC-177B	103587	1.3	Ohms
OC-159	103588	1.6	Ohms
OC-159A	103589	1.8	Ohms
OC-155	103590	2.3	Ohms
OC-155B	103591	2.8	Ohms
OC-155A	103592	3.5	Ohms
OC-156	103593	3.9	Ohms
OC-157	103594	5.3	Ohms
OC-157B	103595	5.8	Ohms
OC-160	103596	8	Ohms
OC-160A	103597	9	Ohms
OC-157A	103598	11	Ohms
OC-158	103599	14	Ohms
OC-158A	103600	18	Ohms
OC-161	103601	20	Ohms

13/16" I.D. x 1-7/8" O.D. x 1-3/4" L
S.E.E.S. # O.E.M. # Resistance

OC-161A	103602	28	Ohms
OC-161B	103603	32	Ohms
OC-161C	103604	41	Ohms
OC-162	104909	61	Ohms
OC-163	114536	148	Ohms
OC-164	135805	41	Ohms
OC-165	139784	56	Ohms
OC-166	144993	314	Ohms
OC-167	146121	406	Ohms
OC-168	146123	282	Ohms
OC-168A	147281	250	Ohms
OC-169	150071	75	Ohms
OC-170	151171	161	Ohms
OC-171	157302	51	Ohms

1-1/8" I.D. x 2-1/2" O.D. x 2-1/4" L
S.E.E.S. # O.E.M. # Resistance

OC-172	105462	pending	
OC-172A	13463	2.8	Ohms
OC-172B	13464	3.7	Ohms
OC-172C	13467	6	Ohms
OC-172D	13469	10	Ohms
OC-173	13470	15	Ohms
OC-173A	13471	17	Ohms
OC-174	13474	39	Ohms

1-1/8" I.D. x 2-1/2" O.D. x 2-1/4" L
S.E.E.S. # O.E.M. # Resistance

OC-175	13475	45	Ohms
OC-176	13476	52	Ohms
OC-176A	13477	70	Ohms
OC-176B	13480	116	Ohms
OC-176C	13481	155	Ohms
OC-176D	13482	175	Ohms
OC-176E	13484	270	Ohms
OC-176F	103582	11	Ohms
OC-178	136228	241	Ohms

1-5/8" I.D. x 3-1/2" O.D. x 3-1/4" L
S.E.E.S. # O.E.M. # Resistance

OC-179A	12932	1.6	Ohms
OC-179	12934	2.4	Ohms
OC-180	12937	4.5	Ohms
OC-180A	12939	5.7	Ohms
OC-181	12940	7.9	Ohms
OC-182	12941	8.5	Ohms
OC-183	12942	12.5	Ohms
OC-182A	12944	18.7	Ohms
OC-182B	12947	37	Ohms
OC-184A	12950	62	Ohms

Coils

21/32" x I.D. x 1-5/16" O.D. x 1-3/8" L

S.E.E.S. #	O.E.M. #	Resistance
OC-202	222DS1	0.0011 Ohms
OC-203	222DS2	0.0015 Ohms
OC-204	222DS3	0.0018 Ohms
OC-205	222DS4	0.0037 Ohms
OC-206	222DS5	0.005 Ohms
OC-207	222DS6	0.0108 Ohms
OC-208	222DS7	0.0157 Ohms

21/32" I.D. x 1-5/16" O.D. x 1-7/16" L

S.E.E.S. #	O.E.M. #	Resistance
OC-190	222DF2	0.005 Ohms
OC-191	222DF3	0.008 Ohms
OC-193	222DF5	0.02 Ohms
OC-194	222DF6	0.04 Ohms
OC-195	222DF7	0.25 Ohms
OC-196	222DF8	0.003 Ohms
OC-198	222DF10	0.03 Ohms
OC-199	222DF11	0.05 Ohms
OC-201	222DF13	0.26 Ohms



OC-190 thru OC-201

9/16" I.D. x 1-5/16" O.D. x 1-7/16" L

S.E.E.S. #	O.E.M. #	Resistance
OC-209	222FA1	0.05 Ohms
OC-210	222FA2	0.08 Ohms
OC-211	222FA3	0.13 Ohms
OC-213	222FA5	0.34 Ohms



OC-202 thru OC-208



OC-209 thru OC-213

OC-214

25/64" I.D. x 1" O.D. x 1-1/32" L

S.E.E.S. #	O.E.M. #	Resistance
OC-214	222A2	62 Ohms

13/32" I.D. x 1-1/8" O.D. x 51/64" L

S.E.E.S. #	O.E.M. #	Resistance
OC-216	222DK1	1520 Ohms
OC-217	222DK2	1520 Ohms
OC-218	222DK3	1520 Ohms
OC-219	222DK4	3080 Ohms



OC-216 thru OC-219



OC-111A thru OC-111J

Brake Coils

4-1/32" I.D. x 6-1/4" O.D. x 5-3/4" L

S.E.E.S. #	O.E.M. #	Resistance
OC-111A	222J1	149 Ohms
OC-111D	222J5	787 Ohms
OC-111E	222J9	373 Ohms
OC-111F	222J10	317 Ohms
OC-111G	222J11	54 Ohms
OC-111H	222J12	500 Ohms
OC-111I	222J14	84 Ohms
OC-111J	222J15	16 Ohms

Brake Coils

3-3/32" I.D. x 5" O.D. x 5-1/4" L

S.E.E.S. #	O.E.M. #	Resistance
OC-215A	222KA1	188 Ohms
OC-215	222KA5	137 Ohms
OC-215E	222KA6	55 Ohms



OC-215A thru OC-215E

Brush Holders

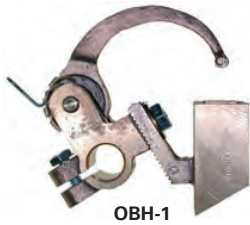

OBH-1



OBH-2



OBH-3



OBH-4



OBH-5



OBH-6 thru OBH-8



OBH-8A thru OBH-9



OBH-10

S.E.E.S. #	O.E.M. #	Dimensions
OBH-1	131468, 6134G1	5/8" x 1-1/2", 5/8" stud, short base
OBH-2	140535	5/8" x 1-1/2", 5/8" stud, long base
OBH-3	6134G6	3/8" x 1", 5/8" stud, long base
OBH-4	6134G7	3/8" x 1", 5/8" stud, short base
OBH-5	140538	5/8" x 1-1/2", 7/8" stud, long base
OBH-6	6134A1	5/8" x 1-1/2", stud 7/8"
OBH-7	6134B2, B5	3/8" x 1-1/2", stud 7/8"
OBH-8	6134C2	3/8" x 1-1/2", stud 5/8"
OBH-8A	6134D2	3/8" x 1-1/2", stud 5/8"
OBH-9	6134B1, B4	1/2" x 1-1/2", stud 7/8"
OBH-11	6134H1	.375" x 1", for 7/8" brush stem

Spring Clip

S.E.E.S. # Dimensions

OBH-10 Spring clip for constant pressure brush holder, brush box 3/4" x 2-15/16"

Brushes



OCB-1, OCB-2, OCB-3

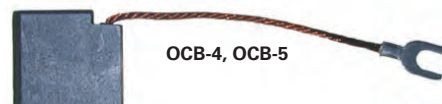

OCB-4, OCB-5



OCB-6 thru OCB-17

S.E.E.S. #	O.E.M. #	Thick	Width	Length	Material	Grade
OCB-1	240B3	1/2	1-1/2	2	Carbon	OE127
OCB-2	240B4	1/2	1-1/2	2	Graphite	OE116D
OCB-3	240B6	5/8	1-1/2	2	Carbon	OE127
OCB-4	240C1	1/4	1	1-1/8	Graphite	OE116D
OCB-5	240G1	1/2	1	1-1/2	Graphite	OE122
OCB-6	240E2	1/2	1-1/2	2-3/4	Carbon	OE117
OCB-7	240E4	5/8	1-1/2	2-3/4	Carbon	OE117
OCB-8	240E8	5/8	1-1/2	2-3/4	Carbon	OE116D
OCB-9	240E10	1/4	7/8	2	Carbon	OE116D
OCB-10	240E13	3/8	1	2-3/4	Carbon	OE116D
OCB-11	240E14	3/8	1-1/4	2-3/4	Graphite	OE116D

Brushes

S.E.E.S. #	O.E.M. #	Thick	Width	Length	Material	Grade
OCB-12	GS240E14	3/8	1-1/4	2-3/4	Graphite	OE130
OCB-13	240E16	3/8	1-1/2	2-3/4	Graphite	OE116D
OCB-14	240E17	3/8	1-3/4	2-3/4	Graphite	OE116D
OCB-15	240E18	3/8	2	2-3/4	Graphite	OE116D
OCB-16	240E20	5/8	1-3/4	2-3/4	Graphite	OE116D
OCB-17	240E22	3/4	1-3/4	2-3/4	Graphite	OE116D



OCB-18	240F1	1/2	2	2	Carbon	OE116D
OCB-19	240F3	3/8	1	2	Carbon	OE116D
OCB-20	240F11	5/8	1-1/2	2	Carbon	OE116D
OCB-21	240F12	5/8	1-1/2	2	Carbon	OE117
OCB-22	240F14	3/8	1	2	Carbon	OE116D
OCB-23	240F15	7/8	1-1/2	2	Graphite	OE116D
OCB-24	240F19	1/2	1-1/2	1-3/4	Graphite	OE116D
OCB-24A		1/2	1-1/2	1-3/4	Graphite	H41
OCB-25	240F20	3/8	1-1/2	2	Graphite	OE116D
OCB-26	240F21	1/2	1-1/2	2	Carbon	OE127
OCB-27	240F22	3/8	1	2	Carbon	OE127
OCB-28	240F23	5/8	1-1/2	2	Carbon	OE127
OCB-29	240F25	5/8	1-1/2	2	Graphite	OE130
OCB-30	240F26	3/8	1	2	Graphite	OE130
OCB-30A	240F27	5/8	1	2	Graphite	OE130



OCB-31	240J1	3/8	1-1/2	1-3/4	Graphite	OE116D
OCB-31A	240J2	1/2	1-1/2	2	Carbon	OE127
OCB-31B	240J3	3/8	1-1/2	1-3/4	Carbon	OE140



S.E.E.S. #	O.E.M. #	Thick	Width	Length	Material	Grade
OCB-32	240P1	3/8	1-1/2	1-3/4	Graphite	OE116D
OCB-33	240P2	3/8	1-1/2	1-3/4	Carbon	OE127
OCB-33A	240P9	3/8	1-1/2	1-3/4	Carbon	GRH619
OCB-36	240P3	3/8	1-1/2	1-3/4	Graphite	OE130

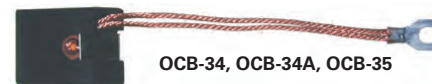

OCB-34	240R1	1/2	1-1/2	2	Carbon	OE150
OCB-34A	240R3	1/2	1-1/2	2	Carbon	OE151
OCB-35	240R5	1/2	1-1/2	2	Graphite	OE152
OCB-37	240AA1	.492	1.56	2.0	Carbon	OE151
OCB-37A	240AA3	.497	1.56	2.0	Carbon	OE127
OCB-37B	240AA4	.49	1.57	2.0	Carbon	OE127



OCB-38	240W3	1/2	1-1/2	2	Carbon	OE153
OCB-39	240T1	3/8	1	2	Carbon	OE130
OCB-39A	240T5	3/8	1	2	Carbon	OE154
OCB-41	240W1	1/2	1-1/2	2	Carbon	OE151
OCB-44	240R9	1/2	1-1/2	2.125	Carbon	OE157
OCB-45	240T9	3/8	1	2	Carbon	OE157

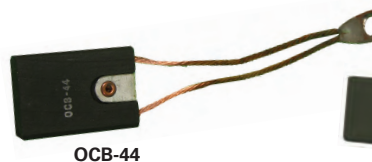

Brushes



OCB-40A, OCB-40B



OCB-40



OCB-43



OS-70A

S.E.E.S. #	O.E.M. #	Thick	Width	Length	Used On
OCB-40A	1450941/4	1/4	11/16	J2A Motor	6850A Selector (OS-70)
OCB-40B	186142	1/4	5/16	11/16	6850A Selector
OCB-42	240BA1	1/4	1/2	3/4	6333CC1 (ODO-75D), 6333CC2 (ODO-75C)

S.E.E.S. #	O.E.M. #	Thick	Width	Length	Material	Door Operator
OCB-40	186207	1/4	3/8	1	Carbon	6970A, 1/2hp

■ Used on 6333AJ2 and 6333AL1 Door Motors (ODO-75).

S.E.E.S. #	O.E.M. #	Thick	Width	Length	Material	Used On
OCB-43	625A682HA001	1/4	1/2	3/4	Carbon	DC Motors, ODO-75C and ODO-75D

S.E.E.S. #	O.E.M. #	Thick	Width	Length	Selector
OS-70A	J0240A1	1/4	5/16	11/16	OLL Selector Motor



OCC-1



OCC-7



ORC-1



OSR-3



OSC-1



OSC-4



OSC-6



OSC-6A



OSC-11



OSC-16



OSC-22

Contacts

S.E.E.S. #	O.E.M. #	Dimensions	Hole Dia.	Material
OCC-1	154AA1	1" sq. x 1-1/4"	5/16"	Graphite
OCC-1A	154AA1	1" sq. x 1-1/4"	5/16"	Carbon
OCC-2	154AB1	7/16" sq. x 29/32"	5/32"	Carbon
OCC-3	154AB2	7/16" sq. x 29/32"	5/32"	Graphite
OCC-4	154C1	5/8" sq. x 1"	3/16"	Carbon
OCC-5	154C2	5/8" sq. x 1"	3/16"	Graphite
OCC-6	154G1	1-1/4" sq. x 1-1/2"	5/16"	Carbon
OCC-7	1077	2" x 2" x 1"		Carbon

S.E.E.S. #	O.E.M. #	Dimensions	Material
ORC-1	1113	1/2" dia. x 3/4"	Carbon
ORC-2	1312	1/2" dia. x 7/8"	Carbon
ORC-3	1576	3/4" dia. x 7/8"	Carbon
ORC-4	1310	1" dia. x 5/8"	Carbon
ORC-5		1-1/4" dia. x 2"	Carbon
ORC-6	1577	1-1/2" dia. x 1"	Carbon
ORC-7		1-1/2" dia. x 2"	Carbon
ORC-8		2" dia. x 2"	Carbon

Round Slotted Carbon Contacts

S.E.E.S. #	O.E.M. #	Dimensions	S.E.E.S. #	O.E.M. #	Dimensions
OSC-1	1197	1/2" diameter x 1/2"	OSC-12		7/8" diameter x 1"
OSC-2	144553	1/2" diameter x 11/16"	OSC-13	114255	1" diameter x 3/4"
OSC-3	1123	1/2" diameter x 1"	OSC-14		1" diameter x 7/8"
OSC-4	103921	5/8" diameter x 1/2"	OSC-15	1168	1" diameter x 1"
OSC-5		5/8" diameter x 5/8"	OSC-16	1173	1" diameter x 1-13/16"
OSC-6		5/8" diameter x 3/4"	OSC-17	1207	1-1/2" diameter x 3/4"
OSC-6A		5/8" diameter x 1"	OSC-18	1194	1-3/4" dia. x 1-3/8"
OSC-7	121992	3/4" diameter x 3/4"	OSC-19	1203	2" diameter x 1-1/16"
OSC-8	1144	3/4" diameter x 7/8"	OSC-20	1195	2-1/4" dia. x 1-3/8"
OSC-10		7/8" diameter x 3/4"	OSC-21	166083	1.75" x .75"
OSC-11		7/8" diameter x 7/8"	OSC-22	169941	1.75" x 1.5"

Contacts

Carbon Contact Holders Stem

S.E.E.S. #	O.E.M. #	Description	Material	Stem	Thread
OCH-1	103623	Holder for 1"	Carbon	2"	3/8-16
OCH-2	141436	Holder for 5/8"	Carbon	1-1/4"	1/4-20
OCH-3	106671	Holder for 1/2"	Carbon	1-1/8"	1/4-20
OCH-5	214SW11	Holder for 1-1/2"	Carbon	1-1/2"	3/8-16
OCH-6	126223	Holder for 1"	Carbon	1-1/2"	3/8-16
OCH-7	109578	Holder for 1-3/4"	Carbon	1-3/4"	1/2-13
OCH-8	108713	Holder for 2"	Carbon	1-3/4"	1/2-13
OCH-10	106184	Holder for 2-1/4"	Carbon	3-5/8"	5/8-11
ORCC-28	150272	Holder with 1/2"	Carbon	2-1/16"	1/4-20



OCH-1

Round Copper Contacts

S.E.E.S. #	O.E.M. #	Face	Stem	Thread
ORCC-1	1559	2-1/2" x 3/8"	3-1/4" x 5/8"	1-3/8" x 1/2"
ORCC-2	1559-S	2-1/2" x 3/8"	2-7/8" x 5/8"	1" x 1/2"
ORCC-3	1561	2-1/2" x 3/8"	2-13/16" x 5/8"	1-1/4" x 1/2"
ORCC-4	13234	2-1/4" x 3/8"	2-7/8" x 1/2"	1-1/8" x 3/8"
ORCC-5	1555	2" x 3/8"	3-1/4" x 5/8"	1-3/8" x 1/2"
ORCC-5A	1555	2" x 3/8"	3/4" x 1/2"	3/4" x 1/2-13"
ORCC-6	13417	2" x 3/8"	2-7/8" x 1/2"	1-3/16" x 3/8"
ORCC-7	106569	1-3/4" x 3/8"	2-3/8" x 7/16"	1" x 5/16"
ORCC-8	1191	1-1/8" x 1/4"	2-7/16" x 7/16"	1-1/8" x 5/16"
ORCC-9	114228	1-1/8" x 1/4"	2-1/8" x 7/16"	1-1/8" x 5/16"
ORCC-10	1189	7/8" x 1/4"	2-5/16" x 7/16"	1" x 5/16"
ORCC-11	1533	7/8" x 3/8"	1-5/16" x 7/16"	1" x 5/16"
ORCC-12		5/8" x 3/16"	1-5/8" x 5/16"	13/16" x 3/16"
ORCC-12A	1534	1" x 1/4"	3/4" x 1/4"	7/8" x 1/4"
ORCC-13	1560	2-1/2" x 3/8"	2-11/16" x 1/2"	1-13/16" x 1/2"
ORCC-14	1558	2-1/2" x 3/8"	1-3/4" x 1/2"	1-7/16" x 1/2"
ORCC-15	130190	1" x 1/4"	2-5/8" x 3/8"	2" x 3/8"
ORCC-16	12852	1" x 1/4"	1-3/4" x 3/8"	1" x 3/8"



ORCC-1



ORCC-5A



ORCC-17



ORCC-25

S.E.E.S. #	O.E.M. #	Description
ORCC-24A	106573, 106574	Insulator Kit for ORCC-24 Contact

S.E.E.S. #	O.E.M. #	Face	Stem	Thread
ORCC-25	113903	1-1/8" x 1/4"	1-1/4"	3/8"
ORCC-26	1503	3/4" x 1/4"	1-3/4"	3/8"
ORCC-27	1528	3/4" x 3/16"	1-1/8"	3/8"
ORCC-28	150272	1/2" x 5/8"	1-1/8"	3/8"

Contacts



OSCC-1 thru OSCC-5

Square Copper Contacts

S.E.E.S. #	O.E.M. #	Face	Stem	Thread
OSCC-1	1436	2" x 1 x 3/8"	2" x 1/2"	1-3/8" x 1/2"
OSCC-2	1387	2" x 1-1/2" x 3/8"	2-5/8" x 1/2"	2-1/8" x 1/2"
OSCC-3	1383	2" x 1-1/2" x 3/8"	1-3/4" x 1/2"	1-1/4" x 1/2"
OSCC-4	1374	1-1/2" x 1-1/2" x 3/8"	2-1/4" x 1/2"	1-3/4" x 1/2"
OSCC-5	1398	1-9/16" x 1-9/16" x 3/8"	1-13/16" x 3/8"	1-5/16" x 3/8"

Car Switch Components



OCS-1



OCS-2



OCS-3



OCS-5



OCS-10



OCS-6A



OCS-11



OCS-15



OCS-16



OCS-13



OCS-17



OCS-18



OCS-22



OCS-23

S.E.E.S. #	O.E.M. #	Description
OCS-1	1571	Segment, Type G brass car switch segment
OCS-2	329F1	Gib cap for gib holder for 5/8" rail
OCS-3	8697	Spring, Type G car switch, spring steel 1" I.D., 1.25" W, 1/2" H
OCS-4	8608	Spring, Type K car switch, spring steel 7/8" I.D., 1" W, 5/8" H
OCS-5	12164	Car switch segment, Type K
OCS-6	137743	Fibre door striker, 5-9/16" L x 13/16" W x 1/2" Thick
OCS-10	1763	Contact door lock, brass
OCS-6A	A154B1	Contact, carbon, 1-5/8" x 1-1/2" x 3/8" Thick, for 21-0 car switch
OCS-9	126388	Car switch, Insulator bushing phenolic
OCS-9A		Car switch, Insulator segment bakelite
OCS-11	1338	Car switch finger, Type K, 1/2" x 1-7/8"
OCS-13	103243	Contact car switch finger, Type G, 1/2" x 2-1/2"
OCS-15	13514	Copper angle, 1-1/16" L x 3/4" W x 1/4" Thick, 5/16" hole
OCS-16	126650	Door lock finger, with wire lead, 5-1/2" L
OCS-17	126391	Car switch finger, Type O
OCS-18	1682	Brass contact, 1" x 2-5/8"
OCS-21	166083	Carbon contact
OCS-22	140759	Car switch contact, metal graphite, 3-1/4" L x 5/8" W
OCS-23	126646	Door lock bridge, 1-3/16" Sq.

Contacts

Paddle Contacts 2-3/4" O.L.

S.E.E.S. #	O.E.M. #	Side A (front)	Side B (back)	Offset 3/32"
01CC-1	153Z1	Plain	Plain	Without (use with OCC-2)
01CC-2	153Z4	Plain	Plain	With
01CC-3	153AE8	7/16" Sq. Silver	---	Without
01CC-4	150Y4	3/8" Rd. Silver	---	Without
01CC-5	150Y6	---	3/8" Rd. Silver	With
01CC-6	150Y7	3/8" Rd. Silver	---	With
01CC-8	153AE10	3/8" Rd. Silver	7/16" Sq. Silver	Without
01CC-9A	153AG5	3/8" Sq. Silver	---	With

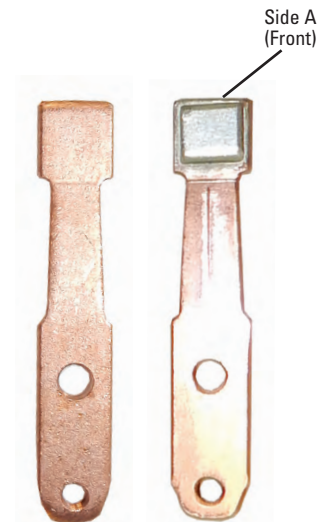

01CC-1 thru 01CC-9A

DC Contactor

S.E.E.S. #	O.E.M. #	Description
ODC-001	AAA638AE6	DC Contactor



ODC-001

Paddle Contacts 4-3/16" O.L.

S.E.E.S. #	O.E.M. #	Face	Offset 1/8"
01CC-10	153B1	Plain	Without (use with OCC-4 Carbon)
01CC-11		Plain	With
01CC-14	150Y2/Y5	3/8" Rd. Silver	Without
01CC-14A	153AG6	1/2" Sq. Silver	Without
01CC-16	150AK2	1/2" Rd. Silver	With



01CC-10 thru 01CC-16



01CC-17, 01CC-18

S.E.E.S. #	O.E.M. #	Description
01CC-17	153T1	Movable paddle contact , 5-1/2" L used on 6744 A and B magnet switch, use with OCC-1 or OCC-1A
01CC-18	153D1	Movable paddle contact , 6-1/2" L used on 6520 magnet switch, use with OCC-6

01CC-19	150AK3	Copper contact with silver tip, 5/8" x 5/8" x 1" L with 1/2" diameter tip
01CC-20	150AL3	Copper contact with silver tip, 7/16" x 7/16" x 13/16" L with 3/8" diameter tip
01CC-21	150W6	Contact with silver tip, 3/8" dia. x 24 thread, 13/16" L
02CC-1	150P4	Movable contact , 2-1/8" L with 1/4" dia. silver tip used for A6164 BP Magnet Switch
02CC-2	93A2	Movable contact , 2-3/4" L with 1/4" dia. silver tip, auxiliary, used for 6830 DC Magnet Switch
02CC-3	93D2	Leaf spring , 1-5/8" L x 5/16" W, used for A6164 BP Magnet Switch



01CC-19, 01CC-20



01CC-21

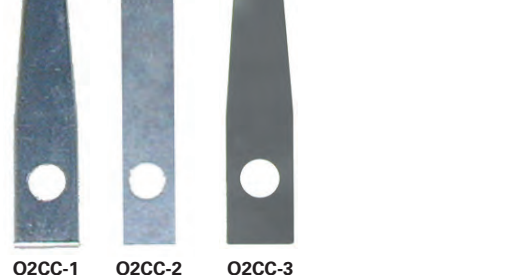

02CC-1 02CC-2 02CC-3

Contacts



S.E.E.S. #	O.E.M. #	Description
O2CC-4	150P7	Contact , with 1/4" dia. silver tip, 2-1/4" L, used for type 6164 Magnet Switch
O2CC-6	150P13	Contact , with 1/4" dia. silver tip, 2-3/4" L, used for type 6164 Magnet Switch
O2CC-5	150P8	Contact , with 1/4" dia. silver tip 3-1/64" L, used for type 6164 Magnet Switch
O2CC-7	150P14	Contact , with 1/4" dia., 3-19/32" L silver tip used for type 6164 Magnet Switch
O2CC-9	150P26	Steel angle contact , with 1/4" dia., 2-5/8" L, silver contact for A6164 Magnet Switch
O2CC-10	150P27	Steel angle contact , 3-3/32" L, with 1/4" dia. silver contact for A6164 Magnet Switch
O2CC-8	150P25	Steel "L" contact , with 1/4" dia. 1-3/4" x 5/8" L silver tip used for type A6164 Magnet Switch
O2CC-11	150C13	Auxiliary contact , with 1/4" dia. 7/16" x 13/16" L silver contact tip used for type 6754 Magnet Switch
O2CC-12	150C14	Auxiliary contact , with 1/4" dia. 7/16" x 13/16" L silver contact tip used for type 6754 Magnet Switch

Door Parts and Equipment



S.E.E.S. #	O.E.M. #	Description
ODO-12A	165D1	Quadrant arm and seal for 7300A Operator
ODO-78	332BC2	Chain assembly with studs for 7300 Door Operator, 37" L
ODO-47	320BE2	Bumper roller for chain of 7300 Door Operator Polyurethane, 3/8" I.D.
ODO-12B	442AL1	Piston for 7300A Operator
ODO-12C	288LK1	Arm lever for 7300A Door Operator
ODO-1A	177AR1	Micro Switch for safe edge
ODO-4	125028	Aircord hitch
OW-200B	395E4	Lever Arm , 14.25
OW-200D	477EA1	Stop , 1-1/2" (38 mm) long 1/2-13 thread
OW-200E	288TJ4	Drive Arm , 33-5/16". 288TJ4
OW-200F		Bronze Bushing for OW-200A
OW-211	AAA456YL1	Roller , 200mm (7.875")

Drive Assembly

S.E.E.S. #	O.E.M. #	Description
OTPC-001	AA21255J15	Drive, E335 AAA21255J15
OTPC-002	AA21255J16	Drive, E335 AAA21255J16
OTPC-003	AAA24350AE1	Drive Asembly, Door Operator
OTPC-004	ACA26800ABB001	MCSS I/O Board
OTPC-005	GHA21270A3	PCB RCB II
OTPC-006	AAA616HK1	Eprom, V-16/V-17 (AAA616LX3)
OTPC-007	AAA616KM2	Eprom, V-20/V-21
OTPC-009	LA4652691-0041	DBSS Board
OTPC-010	AAA26800QMI	CPU
OTPC-011	AAA26800AJV1	MLB III PCB
OTPC-012	AAA26800XH1	PCB, Motion Log
OTPC-013	LA46S02692-0031	PCB, Power Supply
OTPC-014	L46S02945-0012	BRL Control
OTPC-015A	ABA26800AJV2	MLB III PCB
OTPC-016	LA46S03013-0020	PCB, Snubber
OTPC-017	AAA21255J14	Drive E335, AAA21255J14
OTPC-019	ABA26800KK4	PCB, ADISS Board with Loadweighing Device
OTPC-020	ACA26800XH1	PCB, Motion Logic Board (MLB III)
OTPC-022	A8200BE1	PC Board, Gong
OTPC-023	ADA26800HS1	PC Board, Video Received
OTPC-024	C8121AX1	PC Board, LRVM Relay



OTPC-001



OTPC-002



OTPC-003



OTPC-004



OTPC-006



OTPC-007



OTPC-005



OTPC-017



OTPC-019



New features

Loaded is the new standard! Check out all these features that come with every SEES residential elevator package.

- ★ *LED cab lighting*
- ★ *SEEScreen Electronic Door Detector*
- ★ *Dimmer for adjusting light intensity*
- ★ *Built-in emergency battery backup (illuminates 2 lights)*
- ★ *Hoistway door, in place of bulky space-savers / door baffles*
- ★ *Optional on/off switch. Also used as under-cab device to meet code.*



**Fully
LOADED**

SHE comes Equipped LOOK!

The SEEScreen's 94 infrared beams act as an invisible safety curtain across the door entrance. When an obstacle breaks the screen, the sensors detect it and immediately stop the elevator to avoid any accidents.



Made in the USA

S.H.E. is constructed from the finest materials at the SEES Modernization Center in Fort Lauderdale.



Dimmable

SHE cab lights are dimmable so that you can adjust for your desired brightness.



Cab Lights Included

Every elevator comes with four LED lights in the color of your choosing



Back-up power

SHE lights are connected to a backup battery serving as an emergency light.

All the bells and whistles



A : 2781 W. McNab Rd.
Pompano Beach, FL 33069
P : +954.971.1115, +800.526.0026
E : info@seesinc.com

6940A Door Lock

Fig.	S.E.E.S. #	O.E.M. #	Description
1	ODO-67	B6940C2	Door lock assembly, L.H. (shown above)
	ODO-68	B6940C1	Door lock assembly, R.H.
2	ODO-30	306FM1	Contact base for 6940A Door Lock
3	ODO-63	209E1, 172DE11	Roller bearing
4	ODO-18	320AY1	Bumper , Polyurethane, 15/16" W, 1-1/2" L, 5/8" thick
5	ODO-16	320P4	Bumper , Polyurethane, 1-1/2" D, 1-7/16" L
6	ODO-59	307AE1	Lever , bell crank, R.H.
	ODO-60	307AE2, AE4	Lever , bell crank, L.H.
7	ODO-9	77A1	Eccentric pin , 2-1/2"
	ODO-10	77A2	Eccentric pin , 2-7/32"
	ODO-11	77A3	Eccentric pin , 2-11/32"
	ODO-12	77A4	Eccentric pin , 2-19/32"
8	ODO-64	172DE9	Retaining ring , 5/8" (circlip)
9	ODO-17	456BT1	Roller , 1" D x 7/16" W
10	ODO-5	456C1	Skate roller , 1-5/8" L, Rubber
	ODO-5A	1-456C1	Skate roller , Special 0.97" OAL, Use with 1-77A1
	ODO-5P	456C1P	Skate roller , 1-5/8" L, Polyurethane
	ODO-6	456C2	Skate roller , 1-5/32" L, Rubber
	ODO-6-P	456C2P	Skate roller , 1-5/32" L, Polyurethane
	ODO-7	456C3	Skate roller , 1-9/32" L, Rubber
	ODO-7-P	456C3P	Skate roller , 1-9/32" L, Polyurethane
	ODO-8	456C4	Skate roller , 1-1/2" L, Rubber
	ODO-8P	456C4P	Skate roller , 1-1/2" L, Polyurethane
11	ODO-52	90HB9	Spring , Compression
12	ODO-50	92AG1	Torsion spring , 1-25/32" I.D., R.H. (shown)
	ODO-53	A92AG1	Torsion spring , 1-15/16" I.D., R.H. (shown)
	ODO-51	92AG2	Torsion spring , 1-25/32" I.D., L.H.
	ODO-54	A92AG2	Torsion spring , 1-15/16" I.D., L.H.
13	ODO-65	127VB83	Washer , 1-1/2" O.D., 41/64" I.D., 3/64" thick
14	ODO-67A	A316CBA4, 316BJC2	Base , Door lock base, L.H.
	ODO-67B	127L4	Shim , Roller shim for 6940A R
	ODO-67C	127L5	Shim , Roller shim for 6940A R
	ODO-68A	A316CBA3, 316BJC1	Base , Door lock base, R.H.



ODO-67



ODO-30



ODO-68A



ODO-5



ODO-7

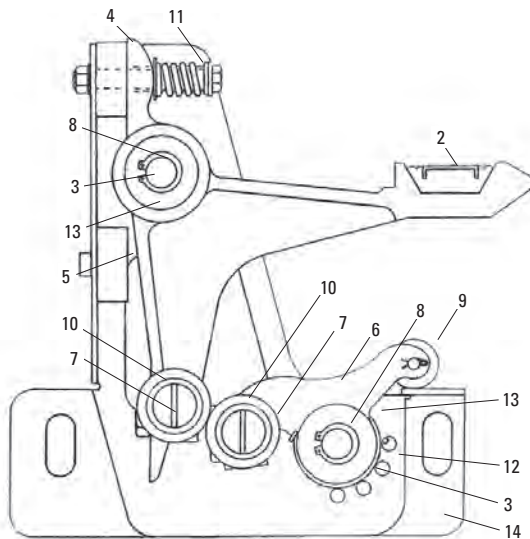

Door Parts and Equipment

6940A Door Lock

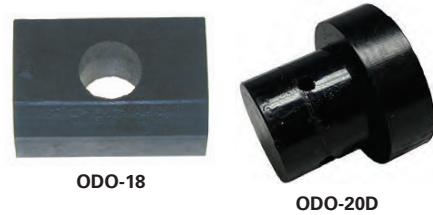
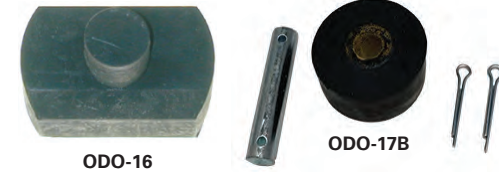

S.E.E.S. #	O.E.M. #	Description
ODO-9	77A1	Eccentric pin, 2-1/2"
ODO-9A	1-77A1	Eccentric pin, Special 1.97" AOL, Used with 1-456C1
ODO-10	77A2	Eccentric pin, 2-7/32"
ODO-11	77A3	Eccentric pin, 2-11/32"
ODO-12	77A4	Eccentric pin, 2-19/32"
ODO-16	320P4	Bumper, polyurethane
ODO-17B	O808 - 456BT1	Roller, 1" O.D. and Shaft with Hardware
ODO-18	320AY1	Bumper, polyurethane, for type 6940A
ODO-20D	320AY1	Door Bumper, 1" Dia Stepped to 11/16" (5/16" Prot x .94" OAL)

■ Eccentric pins compatible with Skate Rollers shown (poly or rubber rollers)

S.E.E.S. #	O.E.M. #	Description
ODO-69	B9940G2	Door Lock Assembly, R.H., 3 Roller
ODO-69A	B9940G4	Door Lock Assembly, L.H., 3 Roller
ODO-69B		Roller, Replacement for ODO-69 Polyurethane
ODO-69C		Shaft, Replacement for ODO-69 with Screw
ODO-69D		Interlock, Door Lock Assy and Mounting Parts
ODO-69F	B9940G4	Door Lock Roller, 1-1/4" L for A7080D Assembly
ODO-69G	456DB3	Door Lock Roller, 1" L for 7080D Assembly
ODO-69H	456DB5	Door Lock Roller, 0.97" L for 7080D Assembly

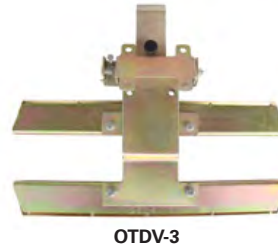

S.E.E.S. #	O.E.M. #	Description
ODO-240	ABA6940CD1	Door Restrictor, cam
ODO-240A	ABA283ANE1	Door Restrictor, flag
ODO-240B	ABA283ANE6	Door Restrictor, flag
ODO-242	ABA283ANE6	Car Door, Vane RH stationary
OTDV-3		Door Vane
ODO-20		Bumper, 1" dia. x 5/8", stem 11/16" dia. x 9/16"
ODO-20A		Bumper, 1" dia. x 3/4", stem 11/16" dia. x 5/8"
ODO-20B		Bumper, 1.25" dia, 1" L, .55" stem
ODO-17	456BT1	Roller, 1" dia. x 7/16" W for 6940A
ODO-17A	78C2	Shaft for ODO-17 roller
ODO-30	306FM1	Contact base for 6940A Door Lock
ODO-47A	138A1	Cup Washer, .525" I.D. x 1.645" O.D. x .375" OAH 16GA TH, Zinc Plated
ODO-47B	320BE4	Bumper, .57" I.D. x 1.5" O.D. x 1" OAH
ODO-47C	310AH6	Bushing, Rubber
ODO-47D	310AH4	Bushing, for Flexible Guide Clamp Type 18D-B

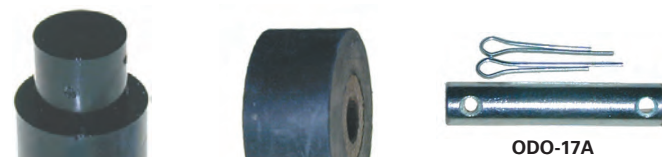

Door Parts and Equipment

S.E.E.S. #	O.E.M. #	Description
ODO-50	92AG1	Spring, R.H., 1- 25/32" I.D.
ODO-51	92AG2	Spring, L.H., 1-25/32" I.D.
ODO-52	90HB9	Compression spring
ODO-53	A92AG1	Torsion spring, R.H.
ODO-54	A92AG2	Torsion spring, L.H. For 6940A Door Lock
ODO-59	307AE1	Lever, bell crank R.H. (shown)
ODO-60	307AE2	Lever, bell crank L.H. For 6940A Door Operator
ODO-62	0-801B2	Sleeve for roller bearing
ODO-63	209E1	Roller bearing
ODO-64	172DE9	Retaining ring, 5/8" (c clip)
ODO-65	127VB83	Washer, 1-1/2" O.D., 41/64" I.D., 3/64"
ODO-66	353Y1	Rubber coupler for "O" operator

S.E.E.S. #	O.E.M. #	Description
ODO-126	456ET1	Roller Used on 456ES1
ODO-202	AAA288AAZ2	Pivot Arm
ODO-203	307AT2	Lever, with Bearing (without Roller and Pin)
ODO-204	77MF1	Pin
ODO-205	77YK1	Pin
ODO-206	CAA340A5	Collar
ODO-207	78FA41	Pin
ODO-209	A96AJ1	Stud
ODO-210	477FK1	Stop Roller, compare with GDO-35A
ODO-211	321W1	Bushing
ODO-212	AAA494LW2	Shaft, for roller
ODO-214	AAA494LW2	Panel Nut 1/2-20 x .20, For Various Hanger & Upthrust rollers with 1/2" Studs
ODO-215	AAA385RF3	Bottom Retainer, Sill Bracket
ODO-216	AAA24479C400	Door Bottom Guide Kit, Gib Assembly
ODO-216A	AAA251DV1	Gib Insert, For ODO-216
ODO-217	133BC1	Washer, For Door Kit
ODO-218	IT2S1	Top Door Retainer, Otis IT2S1
ODO-219	AAA255KK3	Shim, Hanger Bracket Spacer Shim 1/16"

S.E.E.S. #	O.E.M. #	Description
OTLO-1	XAA431Z1	Electric Switch Lock
OTLO-2	XAAA431AB2	Lock, Triangle, left/right
OTLO-2K	XAA431AB1	Key, Triangle
OTLO-3		Key, Landing
OTLO-4	XAA177CR1	Door Lock, Passive
OTLO-5		Door Lock, Side Contact, PB123
OTLO-6		Mandril, for Door Lock
OTLO-9		Roller, for Door Lock 52mm O.D. x 20mm W, bearing 6201 ID:12mm
OTLO-10		Wheel, for Door Lock GS09, 37mm O.D. x 20mm W, ID:12mm
OTLO-13		Door Lock Contact for Otis Elevator
OTLO-15		Door Lock Contact



Door Parts and Equipment



ODO-6940RBK-003



ODO-6940RBK-001

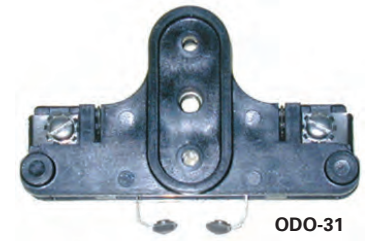

ODO-31



ODO-32



ODO-34

ODO-33

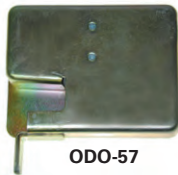

ODO-57



ODO-84



ODO-31B



ODO-35



ODO-35D



ODO-37



ODO-38

6940AG Interlock Switch

S.E.E.S. #	O.E.M. #	Description
ODO-HERK-001	F6178T410	Otis Hall Entrance Refresh Kit, Center Opening Entrance, One per Entrance
ODO-HERK-002	E6178R410	Otis Hall Entrance Refresh Kit, 2 Speed Entrance, One per Entrance
ODO-HERK-003	C6178Y410	Otis Hall Entrance Refresh Kit, Single Slide Entrance, One per Entrance
ODO-OVLRBK-001	DYX10202A403	Otis Interlock Rebuild Kit, OVL Lock
ODO-6940RBK-001	B6940C503	Otis Interlock Rebuild Kit, Full Service 1962-1991, 97-Up
ODO-6940RBK-002	B6940C500	Otis Interlock Rebuild Kit, Min Rebuild for Post 196
ODO-6940RBK-003	B6940C504	Otis Interlock Rebuild Kit, Full Rebuild 92-96, with Red Cont
ODO-6940RBK-004	B6940C502	Otis Interlock Rebuild Kit, Full Service, Vintage Pre-1962
ODO-31	6940AF1	Interlock Switch, complete assembly for Type 6940AG
ODO-31-BRKT		Interlock Switch Bracket, for ODO-35 Replacement Kit
ODO-31B	AA7710202E4	Interlock Switch, 1992-1996 Red Colored Base, Type 6940 Lock
ODO-32	306JJ1	Base, molded plastic for interlock switch, two required
ODO-33	152BE2	Contact, R.H. replacement for switch
ODO-34	152BE4	Contact, L.H. replacement for switch
ODO-57	6940AG1	Switch and housing, R.H., complete assembly includes ODO-31, 32, 33
ODO-58	6940AG2	Switch and housing, L.H., complete assembly includes ODO-31, 32, 34
ODO-84	339FH1	Switch Clip for ODO-31

6940B Interlock Switch

S.E.E.S. #	O.E.M. #	Description
ODO-35	6940BCH49800	Interlock switch, for 6940B interlock assembly
ODO-35C	6940B3	Interlock assembly, R.H., switch and steel cover
ODO-35D	6940B4	Interlock assembly, L.H., switch and steel cover
ODO-35E	90LA3	Spring, 1" L x .281" I.D.
ODO-35G		Screw, for ODO-35
ODO-37	152AV2	Movable contact for interlock switch
ODO-38	152AW2	Stationary contact for interlock switch

Door Parts and Equipment

6098 Switches

S.E.E.S. #	O.E.M. #	Description
OHE-9	A6098A1	Floor Stop Switch , SPDT with arm A287E2, maintains
OHE-10	A6098A3	Floor Stop Switch , DPST, L.H. make, with arm A287E2, maintains
OHE-11	A6098A4	Floor Stop Switch , DPST, R.H. make, with arm A287E2
OHE-12	A6098B1	Limit Switch , SPM with arm ODO-41B (287F4)
OHE-13	A6098B3	Limit Switch , SPB with arm ODO-41A (287F2)
OHE-13A	A6098B11	Limit Switch , SPB with arm ODO-40 (287F6)
OHE-14	A6098B5	Limit Switch , DPM with arm ODO-41B (287F4)
OHE-14A	A6098B15	Limit Switch , DPM with arm ODO-41C (287F8)
OHE-15	6098D1	Tripper Switch , SPB, hand as shown
OHE-16	6098D3	Tripper Switch , SPB, hand opposite
OHE-17	6098E1	Gate Switch , SPM, hand as shown
OHE-18	6098E2	Gate Switch , SPM, hand opposite
OHE-19	6098E5	Gate Switch , DPM, hand as shown
OHE-20	6098E6	Gate Switch , DPM, hand opposite
OHE-21		Limit Switch , DPB 6098 with 287F2 arm & roller
ODO-39	A287E2	Arm with roller , straight long arm, 5-1/4" (shown on OHE-9)
ODO-39A		Arm with roller , 5-1/4" New 3 hole style, straight, with 10 degree offset holes
ODO-40	287F6	Arm with roller , 5-1/4", R.H.
ODO-41	287BA4	Arm with roller , short arm, 3" (shown on OHE-12)
ODO-41A	287F2	Arm with roller , 5-1/4", L.H.
ODO-41B	287F4	Arm with roller , 5-1/4", L.H., mounting holes 10 degrees off center
ODO-41C	287F8	Arm with roller , 5-1/4", R.H., mounting holes 10 degrees off center
ODO-41D	456BY1	Limit Switch Roller , 1-5/8" diameter with nylon bushing, .265" I.D., w: .75"
ODO-41E	0-822R2	Floor Switch Roller , 1-1/4" diameter with bushing, .250" I.D.
ODO-41F		Arm with roller , 5-1/4" R.H. New 3 hole style, straight
ODO-41G		Arm with roller , 5-1/4" L.H. New 3 hole style, straight
ODO-41H		Arm with roller , 5-1/4" R.H. New 3 hole style, 10 degree offset
ODO-41I		Arm with roller , 5-1/4" L.H. New 3 hole style, 10 degree offset



OHE-9

OHE-12

OHE-15

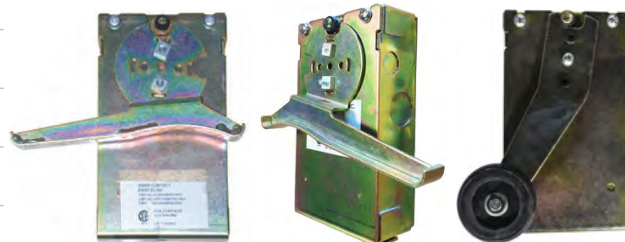

OHE-17, OHE-19

OHE-20

OHE-21



ODO-39

ODO-39A

ODO-40

ODO-41



ODO-41A

ODO-41B

ODO-41C

ODO-41D

ODO-41E



ODO-41F

ODO-41G

ODO-41H

ODO-41I

Door Parts and Equipment



Keys

S.E.E.S. #	O.E.M. #	Description
ODO-45	194AD2	Lunar key, 10-1/2" Emergency Hoistway
ODO-46	194AD7	Key, Double drop door key
ODO-46A	194AD3	Door Key, Single drop
ODO-46B	194AD6	Key, Close couple key
ODO-46C		Door Key, For GEN II Key Plastic Safety Handle
ODO-46D		Door Access Device for GEN II, Stainless Steel Escutcheon Tube and Hardware
MIS-210	320CX1	Bumper, rubber collar for keys
ODO-46-P	AAA194AZ1	Door Key, Double drop with plastic safety handle
ODO-46A-P	AAA194AZ6	Key, Triple Drop, with Plastic Handle and flexible safety shaft

Escutcheons

S.E.E.S. #	O.E.M. #	Description
ODO-73	ES27SS	Escutcheon, Door Key Hole, 2.75" L x 0.5" dia., Lip=0.625" dia., stainless steel
ODO-73A	ES27YB	Escutcheon, Door Key Hole, 2.75" L x 0.5" dia., Lip=0.625" dia., Brass
ODO-73B	386TZ13	Escutcheon, lunar Key
ODO-73C		Escutcheon, lunar Key, brass finish, 1.580" L
ODO-73D	ES27AL	Escutcheon, Door Key Hole, 2.75" L x 0.5" dia., Lip=0.625" dia., Aluminum
ODO-73E	ES20SS	Escutcheon, Door Key Hole, 2.0" L x 0.5" dia., Lip=0.625" dia., Stainless Steel
ODO-73F	ES20YB	Escutcheon, Door Key Hole, 2.0" L x 0.5" dia., Lip=0.625" dia., Brass
ODO-73G	ES20AL	Escutcheon, Door Key Hole, 2.0" L x 0.5" dia., Lip=0.625" dia., Aluminum
ODO-73H	ES15SS	Escutcheon, Door Key Hole, 1.5" L x 0.5" dia., Lip=0.625" dia., Stainless Steel
ODO-73I	ES15YB	Escutcheon, Door Key Hole, 1.5" L x 0.5" dia., Lip=0.625" dia., Brass
ODO-73J	ES15AL	Escutcheon, Door Key Hole, 1.5" L x 0.5" dia., Lip=0.625" dia., Aluminum
ODO-73K		Escutcheon, Door Sleeve, SS 1.75" L x .50" dia. x .625" Lip
ODO-73L		Escutcheon, Door Sleeve, Alum 1.75" L x .50" dia. x .625" Lip
ODO-73M		Escutcheon, Door Sleeve, Alum 3.25" L x .50" dia. x .625" Lip
ODO-73N		Escutcheon, Door Sleeve, Brass 4.0" L x .50" dia. x .625" Lip
ODO-73O		Escutcheon, Door Sleeve, Alum 2.50" L x .50" dia. x .625" Lip
ODO-73P		Escutcheon, Door Sleeve, Alum 2.50" L x .50" dia. x .625" Lip
ODO-73R		Escutcheon, Door Sleeve, Brass 3.25" L x .50" dia. x .625" Lip
ODO-73S		Escutcheon, Door Sleeve, SS 5.00" L x .50" dia. x .625" Lip
ODO-73-SP-NUT		Escutchen Speed Nut, 1/2" for ODO-73 series
ODO-201	CAA340A1	Collar, for Escutcheon
MIS-144		Escutcheon, Hall door key hole, 1-3/4" L for 3/8" dia. keys, 27/64" I.D., 15/16" O.D., 1-1/4" length threaded
MIS-144B		Escutcheon, Hall door key hole, 1-3/8" L, 7/16" I.D., 3/4" O.D.
MIS-189V		Plug Lock, door escutcheon with SEES#5 key





ODO-200A

S.E.E.S. #	O.E.M. #	Description
KOOL-OT2038		OTIS, Rope Pulley Roller Europa
KOOL-OT2090		OTIS, Rope Pulley Roller Prima
ODO-200	AAA483WW11	Track , for Hoistway Door
ODO-200A	AAA483XC40	Track , for Hoistway Door
ODO-76	443J4	Key box glass , 11-3/8" x 1-5/8" x 1/16" replacement glass for Emergency Key Box
ODO-3	288LV1	Lever , hoistway door
ODO-3A	AAA288ZU2	Door Arm Lever , Kit Lever, Collar, hardware
ODO-3B	0826K1, 288LS1	Emergency Kit , Lever, Escutcheon & push nut
ODO-3C		Unlocking Kit , Tall Door Up to 108" Entrance Door Height
ODO-25	A332AS2	Chain with hitch and link for 694 O.D. spring door closer, 11-1/4" L
ODO-26	A332AS3	Chain with hitch and link for 694 O.D. spring door closer, 14-1/4" L
ODO-81	265BD3	Sheave and guard for relating cable
ODO-81A	B316CCB2	Sheave and bracket assembly
ODO-81B	AAA316FHG6	Sheave & Bracket Assembly , L.H.
ODO-81C	AAA316FHG5	Sheave & Bracket Assembly , R.H.
ODO-82	YYL0174HH1	Cable , 12 ft., door detector
ODO-83	YYL0174HH2	Cable , 20 ft., door detector
ODO-74	299ADP2	Spirator bracket
ODO-74A	316DER2	Spirator bracket with offset
ODO-100		Aircord Pulley & Flat Plate Assy 2SPD C/O Application Only
ODO-101	316DER2	Aircord Pulley , 1/8" A-C Steel, 5" O.D. w/ 3/4" Wide Extended Inner Race
ODO-102		Aircord Pulley , 1/8" A-C Steel, 5" O.D. w/ 3/4" Wide Extended Inner Race
ODO-104		Aircord Pulley , 1/8" A-C Steel, 4.4" O.D. w/ Flanged Inner Race, "B" Hanger Application
ODO-105		Pulley, Chain Relating , For Vertical Biparting Doors (Manual and Power)
ODO-107		Aircord Pulley , on Dual Threaded Stud
ODO-108		Pulley 2.5" O.D. & Pin Assembly Used on AAA316GQM1 & 2
ODO-109		Aircord Channel Bracket with Double Pulley , 4" Long x 1.88" H with 3" Hole Spacing
ODO-110		Aircord Channel Bracket with Double Pulley , 4" Long x 1.88" H with 3" Hole Spacing
ODO-112		Aircord Pulley & 7" x 4" Plate Assembly 1/8" A-C Otis MOD C/O Car Tracks & Hangers
ODO-113		Aircord Pulley & Channel Assembly 1/8" A-C Otis C/O Hoistway MOD Tracks & Hangers
ODO-114		Aircord Pulley on Plate - for Weight Closer in OVL, HPLIM Application
ODO-115		Pulley , Aircord 2-5/8" O.D. x 5/16" I.D. Car and Hall Door Systems, Mat Pin AAA65KT2
ODO-120		Spring Closer with Mounting Bracket, R.H.
ODO-121		Spring Closer with Mounting Bracket .5" Offset
ODO-123		Spring Closer with Offset Bracket L.H.
ODO-124		Spring Closer Bracket
ODO-125		Spring Closer Bracket Offset
ODO-127		Air Cord Pulley , Double Groove, 85mm x 12mm with Hdw
ODO-128		Cable Pulley Assembly , Double Bracket
ODO-129		Cable Pulley Assembly with Extended Shaft & Hdw
ODO-130		Cable Pulley Assembly , Sheave and Bracket
ODO-131		Air Cord Pulley , Single Groove, 63.8mm x 8.7mm with Hdw
ODO-3D		Unlocking Paddle Kit , for Standard Door Height w/ 2" SS Escutcheon, Collar & Hdw
MIS-124	6940AR1	Spirator , reel closer, 5" with combo hub
MIS-124-ST		Spirator , 6" SmarTork door closer up to 20% more tension
MIS-124E-20PAC		Spirator , 5" Heavy Duty with Combo Hub, Pack of 20



ODO-76



ODO-3



ODO-3A



ODO-25, ODO-26



ODO-81



ODO-81A



ODO-74

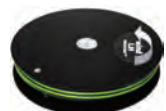

MIS-124-ST



MIS-124



ODO-123

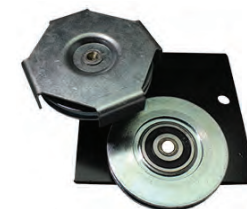

ODO-128

Door Gibs

S.E.E.S. #	O.E.M. #	Description
MIS-197A	AAA6098NS1	Emergency Ceiling Exit, TOC Emergency contact kit
ODO-19A	6168F5	Air Check Valve, new type
ODO-70	2220D16	Door Gib, 8" assembly complete
ODO-71	2213R1	Door Gib, 6-1/4" assembly complete
ODO-71A	251BJ1	Gib Insert, 3", for ODO-70 and ODO-71
ODO-71B		Hardware kit, for ODO-71A used on gib assembly
ODO-71D	456DD1	Gib Roller
ODO-71E		Gib Roller Replacement for ODO-71D
ODO-72	VP869750	Gib, 1/2" offset nylon door guide
ODO-77	237AR2	Door guide, 4-1/2" L, for vertical gates
ODO-77A	237AR1	Door guide, 8" OAL, Bronze



MIS-197A



ODO-19A



ODO-71D



ODO-72



ODO-70



ODO-71E



ODO-71B



ODO-71

ODO-71A

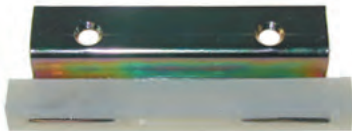

ODO-77



ODO-77A

Door Gibs & Guide Shoes

S.E.E.S. #	O.E.M. #	Description
ODO-79	380BS2	Guide shoe insert, LRV 6-3/4"
ODO-79A	380BV2	Guide shoe insert, 6", LRV
ODO-79B	380AHI	Gib, 15# Rail, Nylon, 1-7/8" x Slot 8-1/2" L x 1-11/16" W x 2-3
ODO-79D	380CE1	Insert, Slide Guide 6 Knob Folding Type
ODO-79E	339LG1	Gib Clip, for ODO-79A, 2 clips required
WDO-59	237GAN	Gib insert for ODO-72 assembly, 4" L
WDO-59G	691B971G05	Solid Gib Bracket, 1/8" Offset, 3-1/2" Lg w/ Gib Insert & hdw
WDO-59H		Gib Assembly, 5/8" Offset x 4" W 1-1/2" Deep, with Gib
ORG-001	380BS2	Insert, Otis 3" round tube rail gib
OTDC-1		Door Control Box, Otis
OTDS-2		Door Gib, 80/50mm x 35mm x 12mm, Canvas
OTDS-3		Door Gib, 80/50mm x 35mm x 12mm, Plastic
OTDS-4		Door Gib, 76mm x 16mm x 13mm
OTDS-5		Door Gib, 70mm x 12mm
OTDS-7		Door Gib, Slider
OTDS-7A		Door Gib, Bracket Only
OTGS-6		Cushion, for Guide Shoe Insert
OTGS-15		Roller, for Roller Guide Assy 160mm x 30mm 6203 Brg I.D. 17
OTGS-20		Guide Shoe Insert, Set of 3 200mm x 25mm x 6mm
OTGS-21		Guide Shoe Insert, Set of 3 200mm x 30mm x 6mm
OTGS-22		Guide Shoe Insert, Set of 3 (1) 215mm x 42mm x 4mm, (2) 203mm x 47mm
OTGS-26		Guide Shoe Insert
OTGS-28		Guide Shoe Insert
OTGS-31		Guide Shoe Insert
OTGS-33-16		Guide Shoe Insert, 100x30x28 16mm
OTGS-38		Guide Shoe Insert for Otis Elevator



ODO-79



ODO-79A



ODO-79B



ODO-79D



ODO-79E



WDO-59



ORG-001



OTDS-2



OTDS-3



OTDS-4



OTDS-5



OTGS-22



OTDS-7



OTDS-7A



OTDC-1

Door Parts and Equipment

S.E.E.S. #	O.E.M. #	Description
ODO-27	195FK1	Sprocket for 7300A Operator, 10 teeth, 1/2" pitch, 1.839" O.D., 5/8 bore for 40ASA roller chain
ODO-27A	195CP2	Sprocket for 30S Operator, 9 teeth, 1-1/4" O.D. x 3/4" wide, 3/8" I.D.
ODO-27B	195GK2	Sprocket , .626 I.D. with 10 teeth
ODO-28	125021	Bearing and seal kit for 6970A Door Operator
ODO-28A	E6970A500	Rebuild Kit , 6970A Door Operator complete kit
ODO-28B	E6970A501	Rebuild Kit , 6970A Door Operator seals and gaskets only
ODO-29	125022	Bearing and seal kit for 7300A Door Operator
ODO-42	132037	Base for "L" and "LA" door lock contact (mounted with ODO-43 or ODO-44)
ODO-43	147976	Contact holder for "L" door lock
ODO-44	156144	Contact holder for "LA" door lock
ODO-48	A306EB2	Interlock switch base with formed leaf spring contact, two required, used on N.O. and N.C. style interlocks
ODO-49	327DJ2C	Cam and clamp assembly for power door operator switches and 6850 selector
ODO-55	6554B1	Mechanical switch , "make" for 6970A door operator
ODO-56	6554B2	Mechanical switch , "break" for 6970A door operator
ODO-61	A325P1	Polyurethane cup for M.L. A6940AD1 to AD3 Door Closer
ODO-61A	A325P2	Guide, Weight (For Travelling Weight Closer)
ODO-66	353Y1	Rubber coupler , O operator



ODO-27

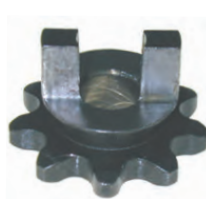

ODO-27A



ODO-28



ODO-28B



ODO-29



ODO-42



ODO-43



ODO-44



ODO-48



ODO-49

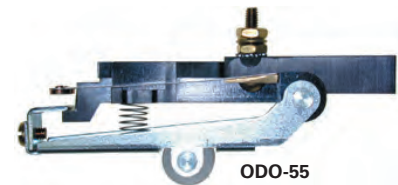

ODO-55



ODO-56



ODO-61



ODO-66

Door Parts and Equipment

Door Motors

S.E.E.S. #	O.E.M. #	Description
ODO-75	6333AJ1	Door motor, 115-230 VDC, 1/2 HP, 1/2" shaft, 1/8" key
ODO-75A	6333BX1	Door motor, 220V, 60 cycle, 900 RPM
ODO-75B	6333AM1	Door motor, 32 oz/ft, 220V, 3 phase 900 RPM
ODO-75C	6333CC2	Door motor/gear assembly, 90 VDC, 69 RPM, 190 in./lb. torque
ODO-75C-A		Brush Cap, for ODO-75C
ODO-75D	6333CC1	Door Motor, 90v, 100-110 RPM, 190 in./lb. torque
ODO-75E	6333DP1	Door Motor, 1140 RPM, 1/6 HP with 1/2" conduit 36" lead
WCB-142		Carbon Brush, for WDO-61
ODO-80	74358	Chain hitch assembly, O operator
ODO-86	209A1	Bearing and bushing set, for 6585A1 chain idler
OCB-42	240BA1	Carbon Brush, 1/2" thick., x 1/4" W x 3/4" L 6333CC1 (ODO-75D), 6333CC2 (ODO-75C)
OBLT-01	AAA717J2, 717B1	Belt, Otis Door Operator Belt
OBLT-002		Door Motor Belt, 2.7m Length
OTLO-13		Door Lock Contact, for Otis Elevator
OTDM-001L		Door Motor, AAA24350BL2
OTDM-001R		Door Motor, AAA24350BL1

Encoders

S.E.E.S. #	O.E.M. #	Description
OTCOD-1A	AAA633L1	Encoder
OTCOD-1B	JAA00633ABF003	Encoder
OTCOD-1C	AAA659C4	Encoder
OTCOD-1D	AAA659C3	Encoder
OTCOD-3		Rotary Encoder, D02 #00 Operator - FAA633B1
OTCOD-4		Rotary Encoder, Otis-LG
OTCOD-6	H100-40-1024UL	Encoder, Otis-LG



Door Parts and Equipment



ODO-13

ODO-14



ODO-14A



ODO-15



ODO-15A



ODO-15B



ODO-15C



Fig. 1



Fig. 2

Connectors



OSS-1A



OBS-1 thru OBS-8

Upthrust Rollers

S.E.E.S. #	O.E.M. #	Description
ODO-13	456CP1	Upthrust roller, 1-3/8" diameter x 1/2" (Spacing 1/2")
ODO-13A	456CP1	Upthrust roller, 1-3/8" O.D. x .580" W Nylon Outer Race, .525" Spacer, 1/2-20 Thrd
ODO-13B	456EK1	Upthrust roller, with Tire, 1.38" Long
ODO-14	456CP2	Upthrust roller, 1-3/8" diameter x 1/2" (Spacing 3/8")
ODO-14A		Upthrust roller, 1-3/8" O.D. x 7/16" W 1/4" Spacer, 1/2-20 Thrd
ODO-15	207Z4	Upthrust roller, 1-3/8" diameter x 7/16" (Spacing 1/8")
ODO-15A	456Z1	Upthrust roller, 3/4" diameter x 7/16" (Spacing 1/8")
ODO-15B	456Z1	Upthrust roller, 3/4" diameter x 7/16" (Spacing 1/8")
ODO-15C	207Z23	Otis Car Bearing
ODO-15D	J619000B204	Upthrust roller, 35mm O.D. x 11mm, 11mm Spcr, M12 Thrd
ODO-15E	AAA456XZ6	Upthrust roller, 35mm O.D. x 11mm, 6mm Spcr, M12 Thrd

Springs

Fig. #	S.E.E.S. #	O.E.M. #	Spring Dia.	Overall Length	Coils	Wire Dia.
1	ODO-24A	91W1	2-19/32"	14-5/8"	30	.331"
1	ODO-24C	91W2	1-3/8"	10-3/4"	64	.125"
1	ODO-23	91W5	1-3/8"	11-3/4"	60	.148"
1	ODO-24	91AE1	1-1/2"	12-1/16"	51	.187"
2	ODO-24B	91T1	2-1/8"	10-3/4"	28	.250"
2	ODO-22C	91T4	1-27/32"	6-3/16"	12	.225"
2	ODO-22D	91T5	1-7/8"	7-1/4"	16	.250"
2	ODO-22E	91T7	1-7/8"	7"	14	.250"
2	ODO-22	91T9	1-11/16"	6-3/4"	18	.187"
2	ODO-22B	91T11	2-7/16"	8"	16-1/2	.312"
2	ODO-22F	91T12	2-9/32"	7-9/16"	17	.281"

Silicone Shunts

S.E.E.S. #	O.E.M. #	Length	Hole I.D.
OSS-1A	175J88	3-3/4"	.193"
OSS-2A	175J89	4-3/4"	.193"
OSS-3A	175J90	5-3/4"	.193"
OSS-4A	175J122	7-5/8"	.193"

Braided Shunts

S.E.E.S. #	O.E.M. #	Shunt Length	Hole I.D.	Hole I.D.	Thick	Width
OBS-1	176AK1	6-3/4"	25/64"	25/64"	3/32"	3/4"
OBS-2	176KA4	7"	17/64"	25/64"	3/32"	1/2"
OBS-3	176KA6	8"	17/64"	25/64"	1/32"	3/4"
OBS-4	176KA8	9-3/4"	17/64"	17/64"	3/32"	3/4"
OBS-5	176KA13	6-3/8"	13/64"	17/64"	1/32"	1/2"
OBS-6	176KA14	6-3/8"	25/64"	17/64"	3/32"	1/2"
OBS-7	176KA3	13-1/2"	21/64"	21/64"	3/32"	3/4"
OBS-8	176KA10	7"	17/64"	17/64"	3/32"	1/2"

Detector Shields

Braided Shunts

S.E.E.S. #	O.E.M. #	Description
OL-1	112926	Triple cable, with 2 leads 13" L
OL-2	264	Cable, 10-1/4" L
OL-3	106594	Cable, 11" L, mounting holes c/c 10-1/4"
OL-5	104148	Double cable, 22-1/2" L
OL-5A	142741	Cable, 16" L
OL-6		Double cable
OL-7	263	Cable, 15-1/4" L
OL-8	175	Braided connector, 8-1/2" L x 1" W
OL-9	118	Braided connector, 4-1/2" L x 1/2" W
OL-10	175H1	Braided connector, 8-1/4" L

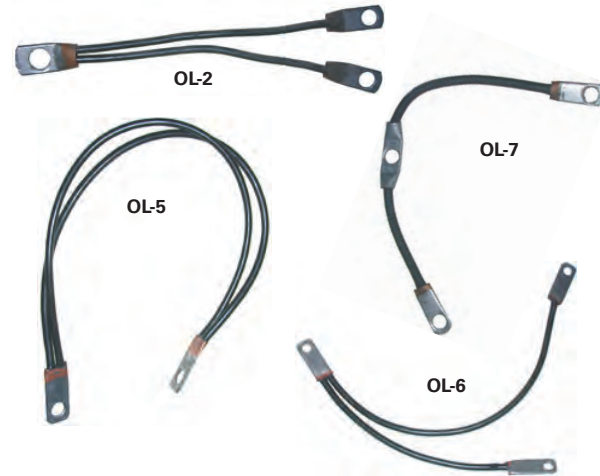

Shape 50ADD female

S.E.E.S.#	O.E.M. #	Description
ODS-4	147EW1, 147FC1, 147EW2, 147FC2	Shield, door faceplate, 69" L, Shield, L.H./R.H. door faceplate, 69" L

Shape 50ADC male

S.E.E.S. #	O.E.M. #	Description
ODS-5	147EY1, 147FB1	Shield, Car door faceplate, 68-3/4" L 15-1/4" L

Shape A50DD female

S.E.E.S. #	O.E.M. #	Description
ODS-2	147CX3	Shield, 84"
ODS-1	278BG2	Shield, 84", Sight Guard, 2-1/2" at door face, 2-1/8" protrusion ribbed face, 3/4" finish leg

Shape A50ADC male

S.E.E.S. #	O.E.M. #	Description
ODS-7	A147EY1, A147FB1	Shield, door faceplate 69-1/8" L 14.88" L

Shape 50AFF male

S.E.E.S. #	O.E.M. #	Description
ODS-9	147JV1, 147JW1, B147JV3, B147JW3	Shield, Faceplate, 84" L, L.H./R.H.

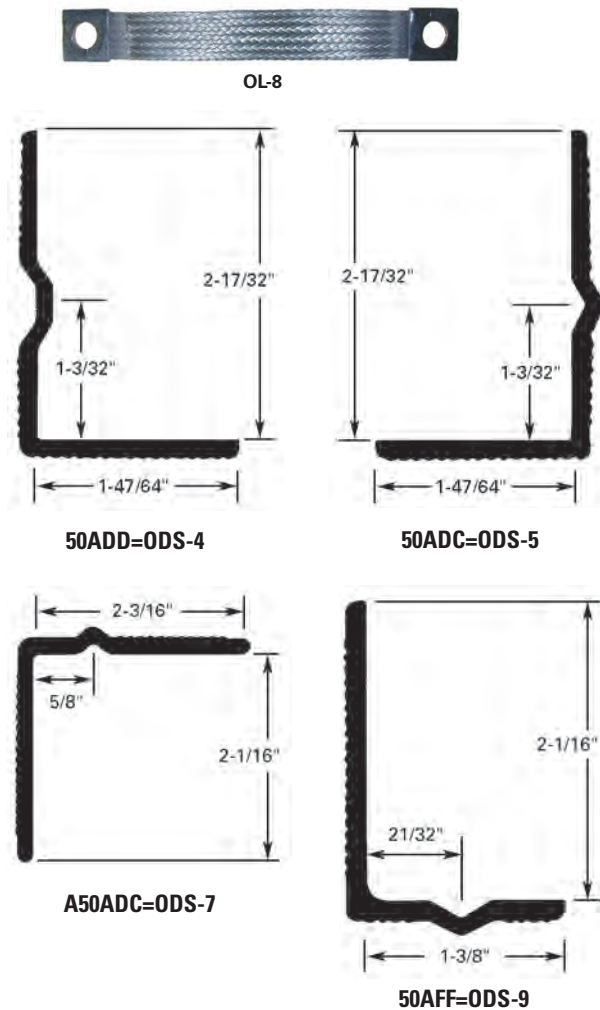

■ Shields are furnished 84" in length and are not pre-drilled to enable the installer to match job requirements. Manufactured in impact resistant butyrate for durability.

Printed Circuit Boards and Electronic Components

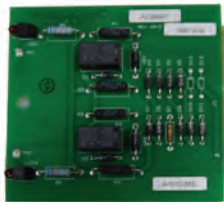

OPC-8

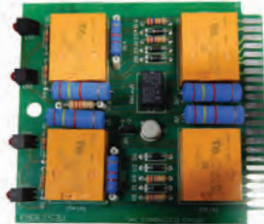

OPC-14



OPC-15

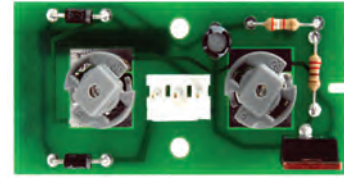

OPC-17

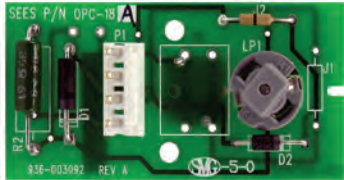

OPC-18



OPC-18A

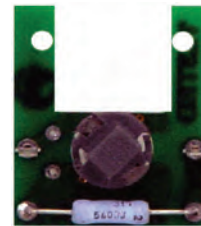

OPC-19

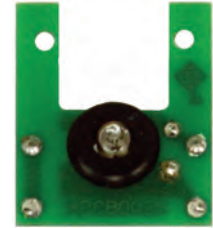

OPC-20

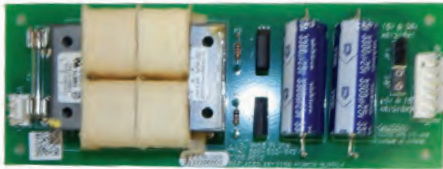

OPC-21

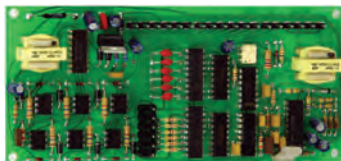

OPC-22



OPC-22A

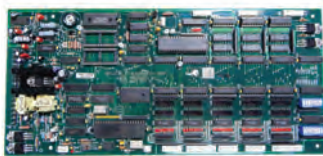

OPC-30



OPCB-80



OPC-26

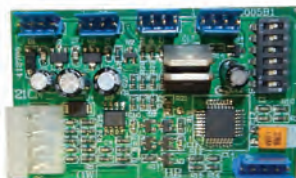

OTCOP-4

S.E.E.S. #	O.E.M. #	Description
OPC-1	6840AY1	Timer, 65 and 73 Controller
OPC-3	7088B1	SCR's, resistors and diodes, 65 and 73 Controller
OPC-4	7088B2	SCR's, resistors and diodes, 65 and 73 Controller
OPC-5	7088C1	Neons, resistors and diodes, 65 and 73 Controller
OPC-6	7088AN1	SCR's, pots, transistors, diodes and neons
OPC-7	7088AM1	SCR's, pots and diodes, 65 and 73 Controller
OPC-8	7088AR1	Relays and neons, 65 and 73 Controller
OPC-9	6840BV1	Power Supply Board
OPC-11	7088AS1	Printed Circuit Board, relay interface
OPC-12	A8121D3	Relay driver - latching interface
OPC-13	A8121E3	Double gong
OPC-14	A8119AK1	Fire Service
OPC-15	A8121B1	Hall/Car Call Board (Terminal Floors)
OPC-16	A8121B2	Hall/Car Call Board (Intermediate Floors)
OPC-17	8200JA1	LRV3 Hall/Car P.I. Board
OPC-18	8200KA1	LRV3 Hall Button Board
OPC-18A	8200KA2	Board, car button
OPC-18B	8200KA3	Board, LED, hall
OPC-18E		PCB Connector, 4pin .156 female PCB Connector 18Ga MTA insulation displacment
OPC-19	8200AL1	Lighted button module
OPC-20	8200AL3	Lighted button module, neon
OPC-21	A8121BA1	LRV3 Power Supply
OPC-22	A8121AY1	LRV3 hall button interface
OPC-22A	E8121BE	Hall Button Interface For LRV IV
OPC-24	A8121AB1	Timer Board
OPC-25	A7048AK1	Pre-amp Board for PC Board
OPC-26	A26800TY1	Board, Otis Pushbutton
OPC-28	ACA22439E6	PCB, Tape Reader Assembly
OPC-30	E8121DB1	PCB, LRV4 Micro Processor
OPC-31	F8121BC1	Micro Controller, F8121BC1
OTCOP-4	GDA25005B1	PCB, COP Address Board RS14
OTPCB-80	B963C2	Pushbutton PCB, Otis B9693C2
OTPCB-80B	B963C3	Pushbutton PBC, Otis B9693C3/B9693C2
OTTT-4	GAA21750AK	Service Tool, Otis

Printed Circuit Boards and Electronic Components

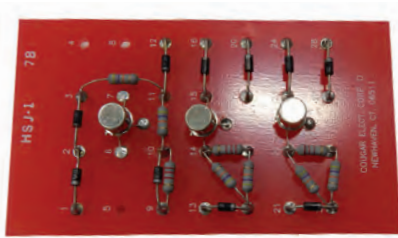

OTB-4



OTB-6



OTB-7



OT-1



OT-2



OT-3



OT-4



OTB-8

S.E.E.S. #	O.E.M. #	Description
OTB-1	XPR	PCB, for hall button
OTB-2	CSG	PCB, for CSG car button
OTB-3	HSJ	PCB, for HSJ hall button
OTB-4	HSG1	PCB, for HSG1 hall button
OTB-5	1A6843R12	PCB, call registry
OTB-6	16840E2	Thyratron board, socket and transistor (less tube)
OTB-7	16480E2SS	Solid State 2050 tube socket (less 607C1 switch)
OTB-8	607C1	Solid State SCR activated switch (replaces 2050 tube)
OT-1	425R1	Oscillator tube, Type 6080 used in 7048 power supplies
OT-2	6N010	Tube, Time delay relay, Thermostatic, octal base 8 pin
OT-2A	2N030	Time delay relay, Thermostatic, octal base 8 pin
OT-3	425G1	Tube, 5727 Cold cathode starter-anode type, octal base 6 pin
OT-4	425P1	Tube, 5751 octal base 8 pin
OT-8A	2040	Solid State Module to replace touch button tubes OT-5 thru OT-8, includes instructions for conversion to conventional button operation
OT-9	425C1	Electronic pickup tube, 2050 Thyratron, octal base 8 pin
OT-10	OA3	Electronic tube
OT-11	P425W1	Digital read-out tube (nixie tube)



OT-8A



OT-9



OT-11

OTIS

Capacitors



OCAP-1



OCAP-2



OCAP-3



OCAP-4, OCAP-5



OCAP-6, OCAP-7

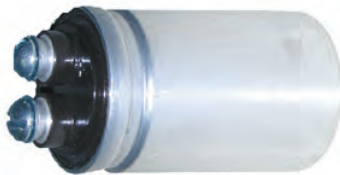

OCAP-8, OCAP-11



OCAP-9, OCAP-10



OCAP-12, OCAP-12A



OCAP-13

Capacitors

S.E.E.S. #	O.E.M. #	Description
OCAP-1	226W1	Capacitor, 1600 MFD, 150 VDC
OCAP-2	226W2	Capacitor, 1600 MFD, 150 VDC capacitor with OCAP-3 resistor on positive terminal
OCAP-14	226W3	Capacitor, 1600 MFD, 200 VDC
OCAP-3	232AE1	Resistor, 250 ohm, used on capacitors
OCAP-4	226H1	Capacitor, 125 MFD, 150 VDC
OCAP-5	226H2	Capacitor, 250 MFD, 150 VDC
OCAP-6	226H3	Capacitor, 125 MFD, 150 VDC capacitor with OCAP-3 resistor on positive terminal
OCAP-7	226H4	Capacitor, 250 MFD, 150 VDC capacitor with OCAP-3 resistor on positive terminal
OCAP-8	226C1	Capacitor, 8 MFD, 450 VDC
OCAP-11	226H5	Capacitor, 5 MFD, 400 VDC
OCAP-9	226D1	Capacitor, 1 MFD, 600 VDC
OCAP-10	226D2	Capacitor, 2.5 MFD, 600 VDC
OCAP-12	226AN1	Capacitor, 5 MFD, 200 VAC-60HZ
OCAP-12A	226AN2	Capacitor, 5 MFD, 200 VAC capacitor with OCAP-3 resistor
OCAP-13	226H9	Capacitor, 250 MFD, 200 VDC
OCAP-1A		Mounting bracket for capacitors 2" diameter

Resistors

700 Watt

Adjustable Resistor 10-1/8"

S.E.E.S. #	O.E.M. #	Resistance
ORES-AA10	232AA10	1.32 Ohms
ORES-AA11	232AA11	1.65 Ohms
ORES-AA12	232AA12	2.08 Ohms
ORES-AA13	232AA13	2.61 Ohms
ORES-AA14	232AA14	3.82 Ohms
ORES-AA15	232AA15	4.93 Ohms
ORES-AA16	232AA16	6.12 Ohms
ORES-AA17	232AA17	9.28 Ohms
ORES-AA18	232AA18	14.1 Ohms



ORES-AA10 thru ORES-AA18



ORES-E121 thru ORES-E144

65 Watt

Adjustable Resistor 8"

S.E.E.S. #	O.E.M. #	Resistance
ORES-E121	232E121	10 Ohms
ORES-E122	232E122	15 Ohms
ORES-E123	232E123	20 Ohms
ORES-E124	232E124	25 Ohms
ORES-E125	232E125	30 Ohms
ORES-E126	232E126	40 Ohms
ORES-E127	232E127	50 Ohms
ORES-E128	232E128	75 Ohms
ORES-E129	232E129	100 Ohms
ORES-E130	232E130	125 Ohms
ORES-E131	232E131	150 Ohms
ORES-E132	232E132	175 Ohms
ORES-E133	232E133	200 Ohms
ORES-E134	232E134	250 Ohms
ORES-E135	232E135	300 Ohms
ORES-E136	232E136	350 Ohms
ORES-E137	232E137	400 Ohms
ORES-E138	232E138	500 Ohms
ORES-E139	232E139	600 Ohms
ORES-E140	232E140	750 Ohms
ORES-E141	232E141	1K Ohms
ORES-E142	232E142	1.5K Ohms
ORES-E143	232E143	2K Ohms
ORES-E144	232E144	2.5K Ohms



ORES-B1 thru ORES-B24

■ Metal bands not included

30 Watt

Adjustable Resistor 3"

S.E.E.S. #	O.E.M. #	Resistance
ORES-B1	232B1	5 Ohms
ORES-B3	232B3	10 Ohms
ORES-B4	232B4	15 Ohms
ORES-B5	232B5	20 Ohms
ORES-B6	232B6	25 Ohms
ORES-B7	232B7	50 Ohms
ORES-B8	232B8	75 Ohms
ORES-B9	232B9	100 Ohms
ORES-B10	232B10	150 Ohms
ORES-B11	232B11	200 Ohms
ORES-B12	232B12	250 Ohms
ORES-B13	232B13	300 Ohms
ORES-B14	232B14	400 Ohms
ORES-B15	232B15	500 Ohms
ORES-B16	232B16	750 Ohms
ORES-B17	232B17	800 Ohms
ORES-B18	232B18	1K Ohms
ORES-B19	232B19	1.25K Ohms
ORES-B20	232B20	1.5K Ohms
ORES-B21	232B21	2K Ohms
ORES-B24	232B24	3K Ohms

Rectifiers



ORT-1



ORT-8



ORT-9



ORT-11



ORT-10

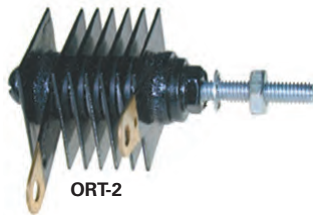

ORT-2

S.E.E.S. #	O.E.M. #	Voltage		Watts	Description
		Input	Output		
ORT-1	230BA1	100 VAC	130 VDC	2000	3 phase, 30 plates, 4 x 5
ORT-4	230BJ4	100 VAC	130 VDC	1000	3 phase, 30 plates, 4 x 4
ORT-6	230BJ1	100 VAC	130 VDC	125	3 phase, 30 plates, 1.6 x 1.6
ORT-7	230BJ2	100 VAC	130 VDC	250	3 phase, 30 plates, 2 x 2
ORT-8	230BJ3	100 VAC	130 VDC	500	3 phase, 30 plates, 2 x 4
ORT-9	230AL2	105 VAC	131 VDC	25	3 phase, 30 plates, 1 x 1
ORT-10	230AV1	104 VAC	44 VDC	350	2 phase, 4 plates, 4 x 5
ORT-11	230AW1	130 VAC	157 VDC	85	3 phase, 30 plates, 1.3 x 1.3
ORT-12	230AY3	115 VAC	93 VDC	45	Single phase, 20 plates, 1.3 x 2
ORT-13	230AG1	156 VAC	190 VDC	250	3 phase, 36 plates, 2 x 4
ORT-14	230AL1	130 VAC	157 VDC	125	3 phase, 30 plates, 2 x 2
ORT-15	230AJ1	130 VAC	157 VDC	400	3 phase, 30 plates, 2.6 x 2.6

S.E.E.S. #	O.E.M. #	Description
ORT-2	230AR1, 230AR2, 230AR3	Rectifier , Single phase, 6 plates, 1" x 1"
ORT-16	230AZ1	Rectifier , Single phase, 6 plates, 1.3 x 2" original, 60 watt 156 VAC in, .85 amp 68 VDC out
ORT-17	230AZ1	Rectifier , Single phase, 8 plates, 1.3 x 2" heavy duty, 176 VAC in, 80 VDC out
ORT-20	LA5P30-1128	IGBT Block , Otis AC Drive O

■ Rectifier electrical parameters equal or exceed OEM specs, minor differences can exist in physical dimensions.



ORT-16, ORT-17



OTF-1



OTF-2

Transformers



OTF-3



OTF-7A



OTF-7



OTF-8

S.E.E.S. #	O.E.M. #	Single Phase Transformers
OTF-1	A225DR1	37 VA , 50-60 Hz, Prim.=105, Sec.=100/150/250
OTF-2	B235AS1	50 VA , 50-60Hz, Prim.=105, Sec.=35/100/170
OTF-3	235BJ1	10 VA , 50-60Hz, Prim.=105/115, Sec.=120/125/130
OTF-5	A235Y1	150 VA , 50-60 Hz, Full load current-0.75 amps, controller voltage: 95-125 Prim.=110/115/120, Sec.=90/180
OTF-6	235BN1	300 VA , 50-60 Hz, Prim.=208/220/240, Sec.=100/135
OTF-7	235BN2	300 VA , 50-60 Hz, Prim.=420/440/480, Sec.=100/135
OTF-7A	235CC2	250 VA , 50-60 Hz, Prim.=208/220/240, Sec.=110/115/120
OTF-8	235CC3	250 VA , 50-60 Hz, Prim.=440/460/480, Sec.=110/115/120
OTF-11B	235CC3	Transformer , 3 Phase, 2KVA, P=d2480/460/440. S=84/100V

Transformers

S.E.E.S. #	O.E.M. #	Description
OTF-4	A7011A2	Saturable Reactor used on door operator
S.E.E.S. # O.E.M. # Three Phase Transformers		
OTF-8A	235G1	250 VA , 50-60Hz, Prim.=208/220/240, Sec.=90/100/105
OTF-8B	235G6	250 VA , 50-60Hz, Prim.=440/460/480, Sec.=90/100/105
OTF-8C	235G2	250VA , 50-60Hz, Prim.=380/418/460, Sec.=90/100/105
OTF-9	235F1	500 VA , 50-60Hz, Prim.=208/220/240, Sec.=100/105
OTF-9A		500 VA , 50-60Hz, Prim.=440/460/480, Sec.=100/105
OTF-10	235A1	1K VA , 50-60Hz, Prim.=208/220/240, Sec.=100/105
OTF-10A	235A6	1K VA , 50-60Hz, Prim.=440/460/480, Sec.=100/105
OTF-11	235B1	2 KVA , 50-60Hz, Prim.=208/220/240, Sec.=100/105
OTF-11A	235B6	2 KVA , 50-60Hz, Prim.=440/460/480, Sec.=100/105
OTF-12	235C1	3 KVA , 50-60Hz, Prim.=208/220/240, Sec.=100/105
OTF-12A	235C6	3 KVA , 50-60Hz, Prim.=440/460/480, Sec.=100/105
OTF-13		Transformer, 341 VA
OTF-14	ABA225JP2	Transformer, ABA225JP2
OTF-15	ABA225JP3	Transformer, ABA225JP3
OTF-16	AAA225JQ1	Transformer, AAA225JQ1
OTF-17	235E6	Transformer, 235E6
OTHT-001		Transformer, 500 VA, Prim. 240V, Sec. 220V

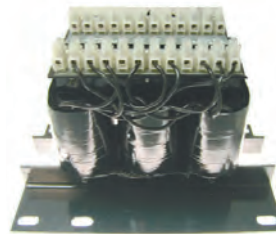

OTF-8A



OTF-8B



OTF-8C



OTF-8D



OTF-9



OTF-9A



OTF-10



OTF-10A



OTF-11A



OTF-12



OTF-12A



OTF-13



OTF-14



OTF-16



OTF-17

OTIS

SEES Cab Lighting

- ★ LED Lighting at 1/5th the energy of halogen
- ★ Affordable price tag
- ★ Built-in emergency battery backup (illuminates 2 lights)
- ★ All kits come with dimmer module

Hot!
Hot!

Light Bulbs

Light kits use readily available ML-162-LED bulbs, so finding replacement bulbs will never be a problem.



S.E.E.S. #	Description
SEES-LED-001K	SEES LED HL Light Kit, Set of 4 bulbs w/ power supply, chrome finish
SEES-LED-002K	SEES LED HL Light Kit, Set of 4 bulbs w/ power supply, gold finish
SEES-LED-003K	SEES LED HL Light Kit, Set of 4 bulbs w/ power supply, white finish
SEES-LED-004K	SEES LED HL Light Kit, Set of 4 bulbs w/ power supply, black finish
SEES-LED-005K	SEES LED HL Light Kit, Set of 6 pure white w/ power supply, chrome
SEES-LED-001-PW	SEES LED HL LED, pure white
SEES-LED-001-PW-B	SEES LED HL LED, bulb only, pure white
SEES-LED-001-PW-F	SEES LED HL LED, fixture and socket
SEES-LED-001-DIM	SEES LED Dimmer Module, for SEES-LED-001-PW-B
SEES-LED-001-DIM-B	SEES LED Dimmer Module, with battery backup
ML-161-LED-W	Lamp, Elevator Cab White LED 12V AC/DC
ML-162-LED-W	Lamp, MR16 White LED Dimmable 12VAC/DC



SEES-LED-001-DIM-B



SEES-LED-001-PW-B



SEES-LED-001-DIM



SEES-LED-001-PW-F



SEES-LED-1-001K



A : 2781 W. McNab Rd.
Pompano Beach, FL 33069
P : +954.971.1115, +800.526.0026
E : info@seesinc.com

Relay Parts

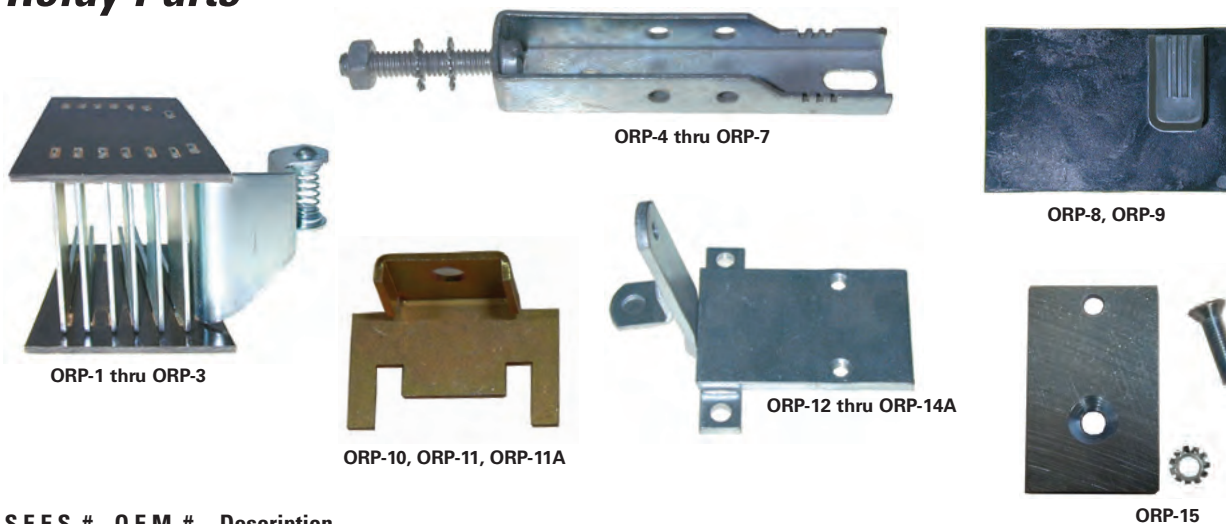

S.E.E.S. #	O.E.M. #	Description
ORP-1	6743A1	Arc deflector for 6744A and B Magnet Switches, 3" L, 2.25" W
ORP-2	6313A1	Arc deflector for 6830 Magnet Switch, 2.5" L, 1.5" W
ORP-3	6534B1	Arc deflector for 6754 Magnet Switch, 1.75" L, 1-1/8" W
ORP-4	179AP3	Holder for carbon contacts OCC-4 and 5
ORP-5	A179AK3	Holder for carbon contacts OCC-2 and 3
ORP-6	179AD1	Holder for carbon contacts OCC-6
ORP-7	179AJ3	Holder for carbon contacts OCC-1 and 1A
ORP-8	276B1	Arc barrier for 6163 Magnet Switch
ORP-9	276H1	Arc barrier for 6754 Magnet Switches
ORP-10	A336BR1	Clamp for carbon holder ORP-5
ORP-11	A336Z1	Clamp for carbon holder ORP-4
ORP-11A	336BN1	Clamp for carbon holder ORP-6 and 7
ORP-12	A245AE1	Armature, 1-1/2 x 2-1/4 x 5/32" thick, for 6754, A and B Magnet Switches
ORP-14A	B245AE1	Armature, 1-9/16 x 2-7/16 x 3/16" thick, for C and E 6754 Magnet Switches
ORP-15	245Z2	Armature for 6164 Magnet Switch
ORP-16	384FS1	Brass guard for 6754 A and B Magnet Switch 1-1/2" W
ORP-16A	A384FS1	Brass guard for 6754 C and E Magnet Switch 1-13/16" W
ORP-18	384FN1	Brass guard for A6164 BP Magnet Switch
ORP-19	384FX1	Brass guard for 6830 DC Magnet Switch 1-3/4" W
ORP-47B	400AY1	Core
ORP-15A	400AY2	Core, set and reset
ORP-20	179AL2	Contact holder for 6830 Magnet Switch
ORP-21	6810A1	Auxiliary contact assembly, without spring for 6754 A and B Magnet Switches
ORP-21A	6810A3	Auxiliary contact assembly, with spring for 6754 A and B Magnet Switches
ORP-22	150H10	Contact, 1-9/16" L with double silver tip, 1/4" diameter x 1-32" thick
ORP-23	150P22	Contact for lower base G and GA contacts
ORP-25	150P23	Contact for 306CE1 base



OTIS

Relay Parts

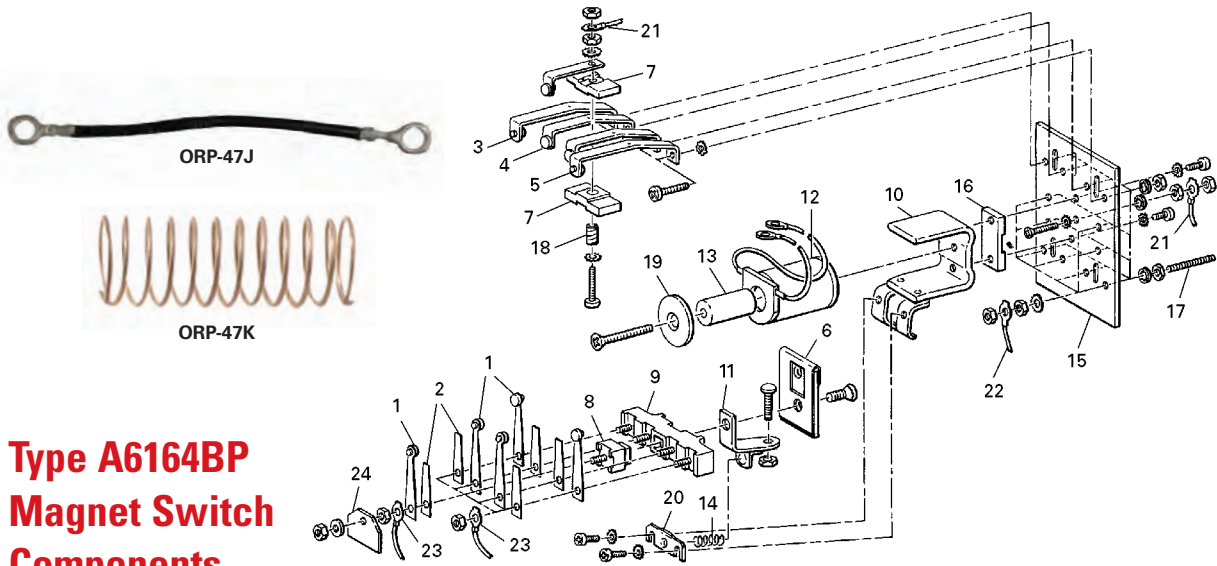

Type A6164BP Magnet Switch Components

Fig.	S.E.E.S. #	O.E.M. #	Description
1	O2CC-1	150P4	Movable contact
2	O2CC-3	93D2	Flat spring
3	O2CC-8	150P25	Stationary contact
4	O2CC-9	150P26	Stationary contact
5	O2CC-10	150P27	Stationary contact
6	ORP-15	245Z2	Armature
6	ORP-18	384FN1	Brass guard
7	ORP-26	306CN1	Contact base
8	ORP-32	306EF1	Contact base
9	ORP-33	306CZ1	Contact base
10	ORP-47	374FV1	Magnet base
11	ORP-47A	A477BH1	Stop
12	OC-19	222CY1	Coil
13	ORP-47B	400AY1	Magnetic core

Fig.	S.E.E.S. #	O.E.M. #	Description
14	ORP-47C	90TA6	Spring
	ORP-47K	90LA4	Spring
	ORP-47L	90VA16	Spring
15	ORP-47D	433AG1	Panel
16	ORP-47E	298BV1	Strip
17	ORP-47F	99G1	Stud
18	ORP-47G	137E5	Tube
19	ORP-47H	131BH1	Washer, magnet core
20	ORP-47I	A477BJ1	Stop
21	ORP-47J	175J6	Conductor
22	OSS-2A	175J89	Conductor
23	OSS-3A	175J90	Conductor
24	ORP-43A	102DA1	Tag, marking



ORP-112



ORP-115



ORP-103

Type A6164BP Magnet Switches

S.E.E.S. #	O.E.M. #	Make	Break
ORP-100	A6164BP104CY1	0M	4B
ORP-103	A6164BP114CY1	1M	4B
ORP-108	A6164BP123CY2	2M	3B
ORP-112	A6164BP132CY2	3M	2B
ORP-113	A6164BP132CY1	3M	2B

S.E.E.S. #	O.E.M. #	Make	Break
ORP-114	A6164BP140CY1	4M	0B
ORP-115	A6164BP141CX1	4M	1B
ORP-116	A6164BP150CY1	5M	0B
ORP-120	A6164BP320CX1	2M	0B
ORP-122	A6164BP332CX1	3M	2B
ORP-124	A6164BP341CX1	4M	1B
ORP-125	A6164BP732CZ1	3M	2B
ORP-126	A6164BP741CZ1	4M	1B

Relay Parts

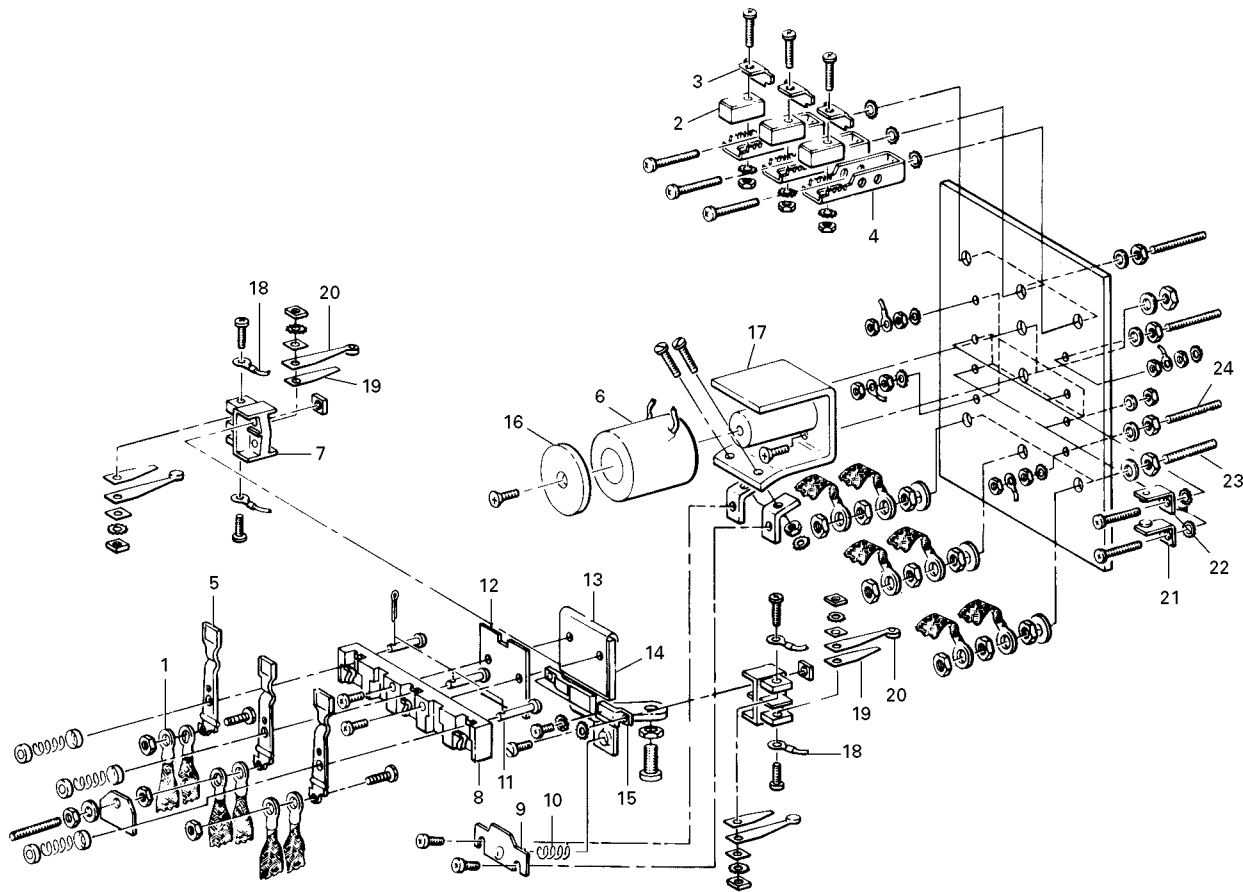

Type E6744A Magnet Switch Components

Fig.	S.E.E.S. #	O.E.M. #	Description	Fig.	S.E.E.S. #	O.E.M. #	Description
1	OBS-4	176KA8	Braided shunt	13	ORP-48E	464AZ1	Brass guard
2	OCC-1	154AA1	Carbon contact	14	ORP-48F	A245AG1	Armature
3	ORP-11A	336BN1	Carbon clamp	15	ORP-48G	316ANZ1	Bracket, auxiliary contact
4	ORP-7	179AJ3	Carbon holder	16	ORP-48H	127AH1	Core washer
5	O1CC-17	153T1	Contact, movable	17	ORP-48I	A374FJ2	Frame
6	OC-36	222CM1	Coil	18	ORP-48J	175J150	Conductor
7	ORP-31	306CJ1	Contact base	19	ORP-48K	93AD1	Flat spring
8	ORP-48	306BM1	Contact base	20	O2CC-2	93A2	Auxiliary contact
9	ORP-48A	A477BR1	Stop	21	O2CC-11	150C13	Auxiliary contact
10	ORP-48B	90JB6	Spring	22	O2CC-12	150C14	Auxiliary contact
11	ORP-48C	141H1	Rivet	23	ORP-48M	99E1	Stud
12	ORP-48D	A384EV1	Separator	24	ORP-47F	99G1	Stud



ORP-48B

Relay Parts

OTIS

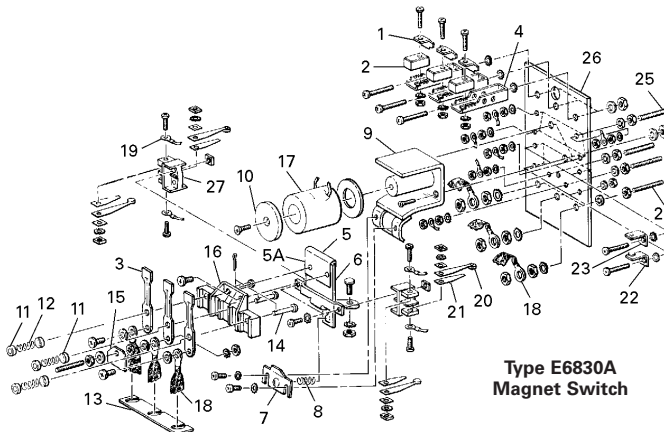
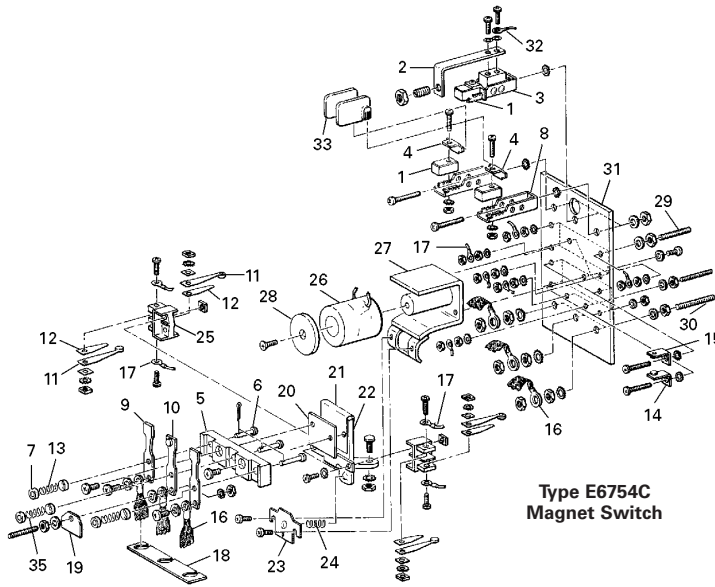

Type E6754C Magnet Switch

Fig S.E.E.S. # O.E.M. # Description

Fig	S.E.E.S. #	O.E.M. #	Description
1	OCC-2	154AB1	Carbon contact
2	ORP-49	179AM1	Contact holder
3	ORP-49A	A179AK5	Contact holder
4	ORP-10	A336BR1	Carbon clamp
5	ORP-28	306BR1	Contact base
6	ORP-49C	141Y1	Rivet
7	ORP-49D	133A6	Washer
8	ORP-5	A179AK3	Contact holder
9	O1CC-2	153Z4	Copper contact
10	O1CC-6	150Y7	Copper contact
11	O2CC-1	150P4	Movable contact
12	O2CC-3	93D2	Contact spring
13	ORP-47C	90TA6	Spring
14	O2CC-11	150C13	Stationary contact
15	O2CC-12	150C14	Stationary contact
16	OBS-5	176KA13	Connector, braided copper
17	OSS-1A	175J88	Conductor
18	ORP-43	464BJ2	Fibre separator
19	ORP-43A	102DA1	Plate, marking
20	ORP-49F	384EW3	Guard
21	ORP-16A	A384FS1	Guard
22	ORP-14A	B245AE1	Magnet armature
23	ORP-49G	A477BL1	Stop
24	ORP-49H	90VA15	Compression spring
25	ORP-31	306CJ1	Contact base
26	OC-60	222EB2	Coil
27	ORP-49I	B374CP1	Magnet frame and core
28	ORP-49J	131AY1	Washer
29	ORP-47F	99G1	Stud
30	ORP-49L	99G2	Stud
31	ORP-49K	A433Z1	Panel
32	ORP-49M	175J204	Conductor
33	ORP-9	276H1	Arc barrier
34	ORP-49N	306CP1	Contact mounting block
35	ORP-49P	90TA3	Spring Compression

Type E6830A Magnet Switch

Fig S.E.E.S. # O.E.M. # Description

ORP-44	A141CV4	Magnetic Switch Assy.	
1	ORP-11	A336Z1	Carbon clamp
2	OCC-4	154C1	Carbon contact
3	O1CC-10	153B1	Copper contact
4	ORP-4	179P3	Carbon holder
5	ORP-19	384FX1	Brass guard
5A	ORP-50	384EW1	Phenolic guard
6	ORP-50A	A245AA1	Armature
7	ORP-50B	A477CP1	Stop
8	ORP-50C	90BB8	Spring
9	ORP-50D	A374FM2	Frame & core
10	ORP-50E	131BD1	Core washer
11	ORP-50F	133A1	Washer
12	ORP-50G	90DB4	Spring

Fig S.E.E.S. # O.E.M. # Description

13	ORP-50H	464BJ3	Separator
14	ORP-50I	141Y2	Rivet
15	ORP-43A	102DA1	Plate, marking
16	ORP-30	306CL1	Contact base
17	OC-9	222CV1	Coil
18	OBS-8	176KA10	Connector
19	ORP-48J	175J150	Conductor
20	O2CC-2	93A2	Contact
21	ORP-48K	93AD1	Flat spring
22	O2CC-11	150C13	Aux contact
23	O2CC-12	150C14	Aux. contact
24	ORP-49L	99G2	Stud
25	ORP-47F	99G1	Stud
26	ORP-50M	433AB1	Panel
27	ORP-31	306CJ1	Contact base



Relay Parts

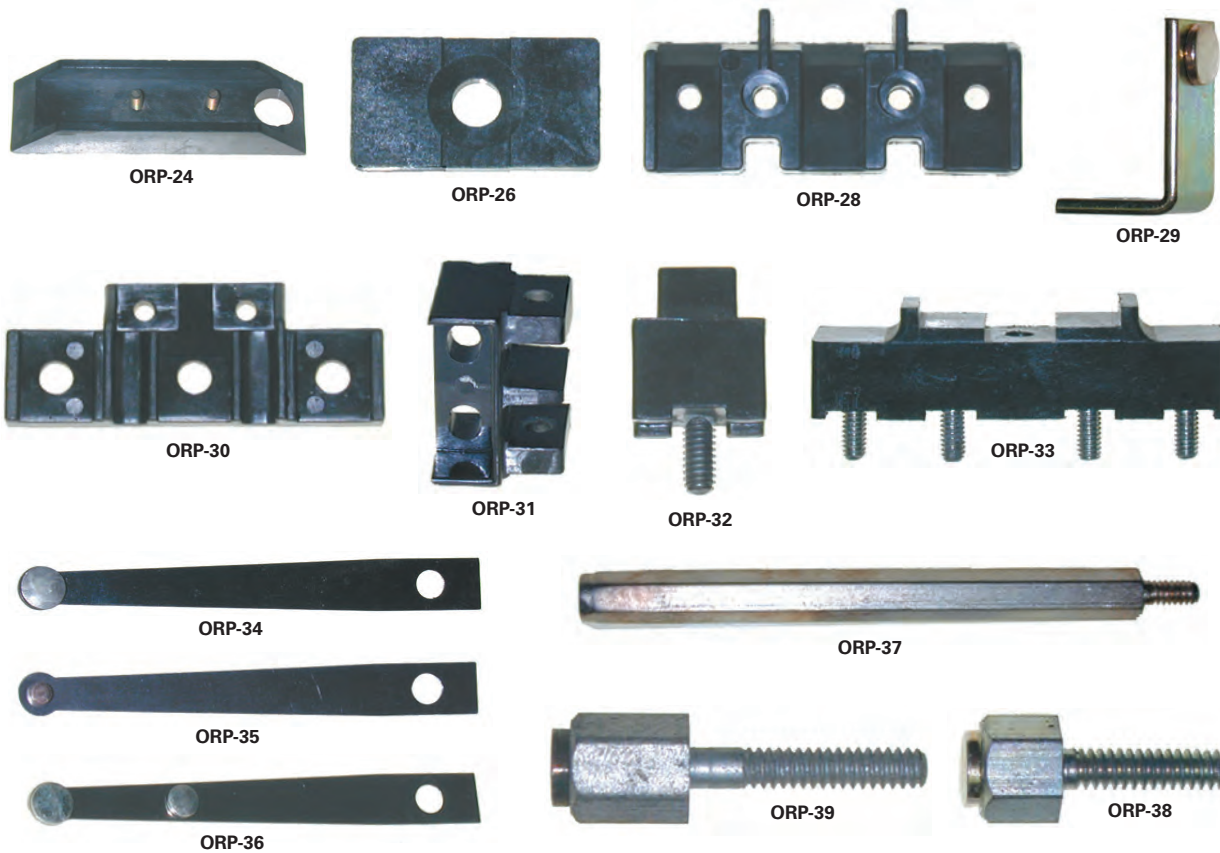

S.E.E.S. #	O.E.M. #	Description
ORP-24	306CE1	Base, upper contacts for G and GA contacts
ORP-26	306CN1	Base, bakelite for 150P25 contact
ORP-28	306BR1, 306BR2	Base, red phenolic for movable paddle contact
ORP-29	152AN1	Contact, stationary auxiliary, for 6744 A and B Magnet Switch
ORP-30	306CL1	Base, bakelite 1" x 9/16" x 4-1/16" for 153B1 copper contact
ORP-31	306CJ1	Base, 1-1/8" L, contact, selector stopping switch
ORP-32	306EF1	Base, bakelite
ORP-33	306CZ1	Base, bakelite for 4 inserts of 150P4
ORP-34	150H2	Contact leaf spring, 2-3/4" L with 1/4" double tip
ORP-35	150HA2	Contact leaf spring, 2-3/4" L with 1/8" double tip
ORP-36	150HA3	Contact leaf spring, 2-3/4" L with 1/4" double contact tip
ORP-37	150C7	Contact, 1/4" hex., 3-1/4" L with silver contact tip
ORP-38	150C2	Contact, 5/16" hex. x 3/4" with silver contact
ORP-39	150C3	Contact, 5/16" hex. x 1-1/8" with silver contact
ORP-40A		Dashpot oil, clear dashpot fluid for overload relay



ORP-40A

Relay Parts



ORP-43



ORP-43A



MIS-100K

S.E.E.S. #	O.E.M. #	Description
ORP-42	153AE6	Copper contact , stationary, 1-3/16" square silver face
ORP-43	464BJ2	Fibre separators
ORP-43A	102DA1	Tag
ORP-44B	P613BY1	Stepper Switch Assembly , 2 level, 40 point, 120 VAC, bi-directional
MIS-100K		Stepper Lube Kit , Assorted lubricants, specially formulated for maintaining stepping switch wear points. Prolongs life, improves performance



OSL-2



OSL-1T

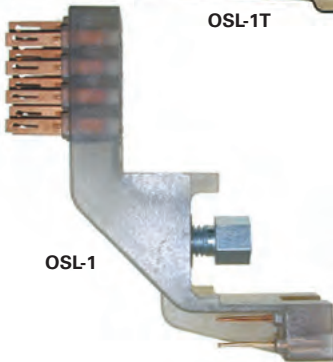

OSL-1



OSL-12



OSL-13

Type 7058B Slimline Relay Components

S.E.E.S. #	O.E.M. #	Description
OSL-1	306JL4	Base , plug in, with maximum available terminals. Used for 2 or 4 lead coils.
OSL-2	245AL2	Armature , with flat spring
OSL-12	477EB1	Stop , contact, phenolic, 1.460" L, used on magnet arrangement 1 and 2
OSL-13	477EB2	Stop , contact, phenolic, 29/32" L, used on magnet arrangement 3 and 4
OSL-1T	187BM1	Terminal for OSL-1 base

Type 7055C Pile Up Contact Assemblies

S.E.E.S. #	O.E.M. #	Contact Arrangement
OSL-3	7055C081	8 break
OSL-4	7055C171	1 make, 7 break
OSL-5	7055C261	2 make, 6 break
OSL-6	7055C351	3 make, 5 break
OSL-7	7055C441	4 make, 4 break
OSL-8	7055C531	5 make, 3 break
OSL-9	7055C621	6 make, 2 break
OSL-10	7055C711	7 make, 1 break
OSL-11	7055C801	8 make



OSL-5

Relay Parts



ORP-45



ORP-45-S



ORP-45A-S



ORP-45B



ORP-45AB



PR-97



ORP-51



PR-15, PR-21, PR-23, PR-24

S.E.E.S. #	O.E.M. #	Description
ORP-45	P613AP6	Relay, 120 VAC, 2 N.O. & 2 N.C., VC15-2A2B-AC120V
ORP-45-S		Relay, 4 pole VC15A-2A2b 120 VAC w/ screw terminals
ORP-45A	P613AP9	Relay, 120 VAC, 3 N.O. & 1 N.C., VC15-3A1B-AC120V
ORP-45A-S		Relay, 4 pole VC15A-3A1B 120 VAC w/ screw terminals
ORP-45B	P613AP7	Relay, 120 VAC, 4 N.O., VC15-4A-AC-120V
ORP-45AB		Clip, mounting for ORP-45, 45A, 45B
PR-15	P613AB9	Relay, 115 VAC, 3 PDT
PR-24	P613AB3,	Relay, 48 VDC, 3 PDT
	KUP14D1548	
PR-23	P613AB1,	Relay, 110 VDC, 3 PDT
	KUP14D15110	
PR-21	P613AB2,	Relay, 110 VDC, 3 PDT
	P613AB8,	
	KUP14D35110	
PR-97	P613AP5	Relay, 115 VDC
ORP-51	613BX7	Relay, 110 VDC, 3 phase, 20 Amp

■ Additional Relays starting on pg 283.

Timers

S.E.E.S. #	O.E.M. #	Description
PR-18B	P613BX1	Timer, 120 VAC, 1-10 second adjustable timer
PR-110	P613AY8	Timer, 120 VAC, 1 to 3 seconds
PR-110A	P613AY9	Timer, 120 VAC, 1 to 10 seconds
PR-110B	P613AY10	Timer, 120 VAC, 1 to 60 seconds
ORP-46	P623B1	Timer, 1 amp, 115 VAC, 120 sec.
ORP-46A		Timer, 1 amp, 115 VAC, 480 sec.
PR-98		Timer, adjustable universal time switch 24-240 Volts AC/DC 1-360 sec.
PR-98A		Timer, 12/240 VAC/DC SPDT, universal adjustable, .1 sec- 20hr on/off delay, compatible with 3", 35mm din rail mounting kit (MIS-004)
PR-98B		Trip Counter, universal electric, 8 digit ICD read out with battery
PR-98C	H7EC-NFV-B	Trip Counter, 8 Digit LCD Read Out with Battery



PR-18B



PR-110



ORP-46A

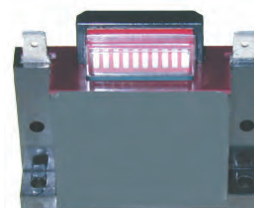

PR-98

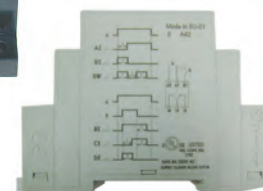

PR-98A

Selector Parts



S.E.E.S. #	O.E.M. #	Description
OS-1	6839D1, 6839D3	Contact brush with 154AD2 contact, short blade 2"
OS-2	6839D2, 6839D4	Contact brush with 154AD4 contact, long blade 2-1/2", for 6851 leveling switch
OS-3	269R1	Indicator with copper finger contact, not shown above
OS-3A	306CH1	Base for OS-1 and OS-2
OS-3B	131BA1	Washer, Hillside washer for OS-1 and 2
OS-35	154AD2, 154AD7	Contacts for OS-1 contact brush 6839D Series, 3/8" x 2"
OS-36	154AD4, 154AD8	Contacts for OS-2 contact brush 6839D Series, 3/8" x 2-1/2"
OS-4	6839F3	Brush contact for crosshead and advancer panel, carbon contact 7/16" L
OS-4A	156J2	Carbon contact, contacts for OS-4
OS-4B		Fiber contact, for OS-12
OS-5	6839F4	Brush contact for crosshead and advancer panel, metal graphite, 7/16" L
OS-6	6839F5	Brush contact for crosshead and advancer panel, carbon contact, 11/16" L
OS-6A	156D5	Carbon contact, contacts for OS-6
OS-37	93CC1	Blade spring for A6839F3 type brush contact
OS-31	6839F2	Brush contact, 7/8" L, carbon contact for crosshead panel
OS-31A	156D2	Carbon contact, contacts for OS-31
OS-59	6839AB1	Contact brush assembly with silver contact and cam
OS-60	327JE1	Cam with silver contact for OS-59
OS-7	6839B2	Brush switch with graphite contact
OS-8	6839B3	Brush switch with silver contact
OS-9	6839B4	Brush switch with fibre cam
OS-41A	327FT2	Cam for selector switch, use with OS-11A
OS-10	327DE2	Cam for selector switch, use with OS-11A
OS-11	0-327A	Cam and clamp, includes OS-10 and OS-11A
OS-11A	336CM1	Clamp only, use with OS-10 or OS-41A
OS-12	6839Y1, 6839Y3	Switch brush, with 7/16" L fibre cam
OS-13	6839Y2, 6839Y4	Switch brush, with 7/16" L carbon

Selector Parts

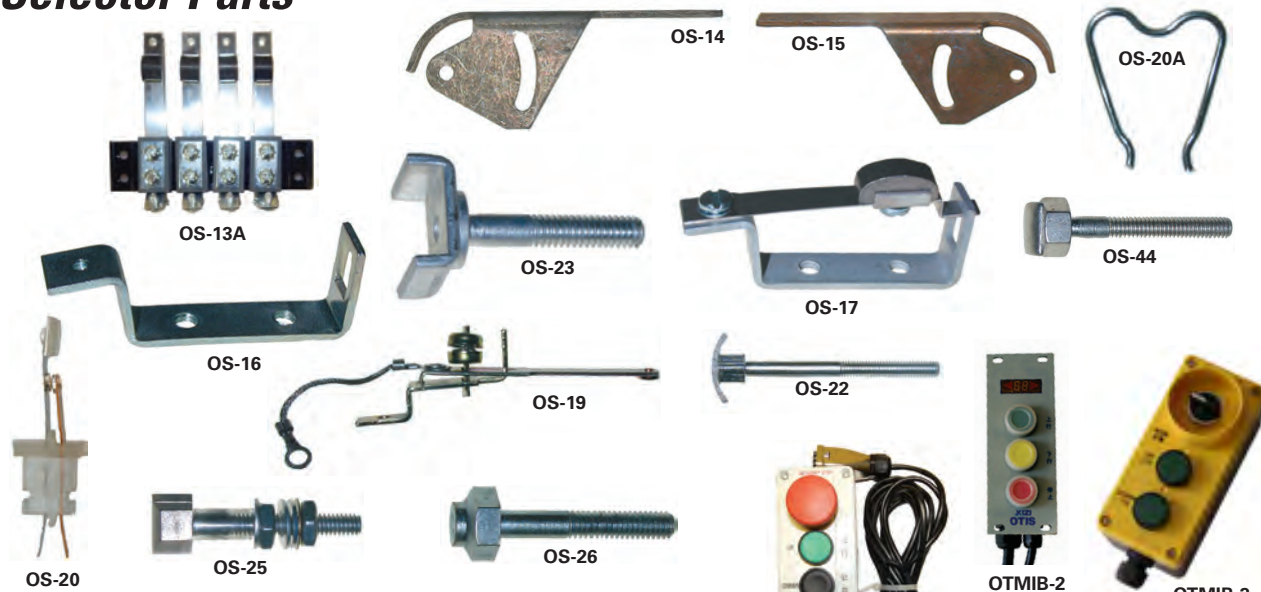

S.E.E.S. #	O.E.M. #	Description
OS-13A	6251E1	Mechanical Switch Set, STPN for A6706A
OS-13B	150BA7	Contact, stationary
OS-14	156H1	Down stop contact for stop control switch
OS-15	156H2	Up stop contact for stop control switch
OS-16	181892	Bracket only for OS-17 and 18 selector brush
OS-17	181893	Selector brush with graphite contact 5/8" for ML6104 crosshead and brush advancer panels and 140M selector
OS-18	181894	Selector brush, same as above but with graphite contact 15/16"
OS-19	156AB2	Contact finger and spring guide
OS-20	177AH1	Brush switch
OS-20A	339FV1	Clip for OS-20 brush switch
OS-44	156AV2, 156G4, 502236	Selector contact, 1-1/2" L
OS-22	0-347	Selector contact, 2-1/2" x 3/8" x 3/4" contact face with 3/4" radius
OS-23	152AX2, 156AX2	Cam selector, 7/16" wide, "U" form
OS-24	152AX4, 156AX4	Cam selector, 5/8" wide, "U" form
OS-25	6850F2	Selector contact
OS-26	150C10	Selector contact, 3/8" hex w/ 1/4" dia. silver tip, overall 1-5/16" L with 8-32 thread
OTMIB-1		Inspection Station, 4 Button w/ Emergency Stop
OTMIB-2		Movable Inspection Box
OTMIB-3		Switch, Emergency Electric Box
OTMIB-4		Switch Panel, Control Cabinet Inspection Box
OTMIB-5		Switch Panel, Control Cabinet Inspection Box
OTMIB-6	XBA24830D4	Inspection Box Of MCS321
OTMIB-7	XAA24350AD3	AT25 Inspection Box Of MCS321
OTPIB-3		Switch Panel, Car Top Inspection Box For GEN 2
OTSS-3	XAA177AZ4	Sensor, Photo
OTSS-4	SSGD-1H(NO)	Sensor, Photo
OTPO-1		Master Feeder Box
OTHUB-1		Block Terminal
OTHUB-2		Block Terminal
OTHUB-3	P303BA5	Block Terminal



Selector Parts



OS-27



OS-28



OS-29



OS-32

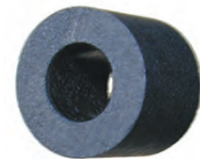

OS-33



OS-30



OS-34

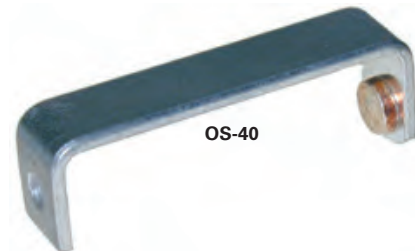

OS-40



OS-42

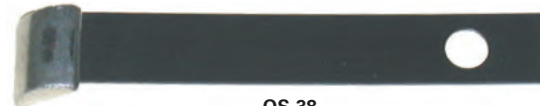

OS-38



OS-43



OS-44



OS-45



OS-45B

S.E.E.S. #	O.E.M. #	Description
OS-27	102990	Finger contact, floor selector
OS-28	B152H2	Contact floor bar, rectangular head, 3/8" x 5/8", 2-11/32" L with 10-32 thread
OS-29	150P31	Contact for selector stopping switch with fibre cam, blade 3/8" x 3-1/8" with 1/4" dia. contact tip
OS-30	150P32	Contact blade, makes with OS-29
OS-32	15387	Floor selector roller, copper 1/2" x 1/2"
OS-33	1659	Floor selector roller, metal graphite 1/2" x 1/2"
OS-34	156E1, E2, E3	Selector contact, 1-11/32" L with 8-32 threaded stem
OS-38	156A6	Selector contact
OS-39	150P33	Pawl magnet contact, 1-5/8" L for crosshead panel
OS-40	150P34	Pawl magnet contact, 1-1/2" L for crosshead panel
OS-42	327GJ1	Cam, toggle cam for advancer panel
OS-43	327GS1	Cam on bracket used at end of crosshead panel
OS-44	156AV2, 502236	Floor bar contact
OS-45	306GD1	Contact base for three (3) OS-44 contacts, for floor bar assembly
OS-45A	306GD2	Contact base for one OS-44 contact
OS-45B	306GD3	Contact base for two OS-44 contacts

Selector Parts

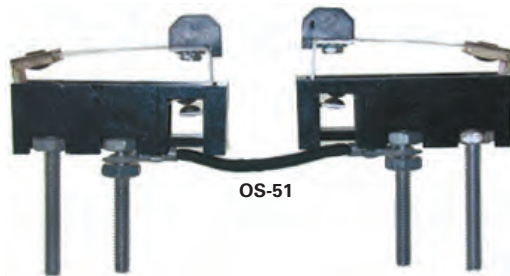
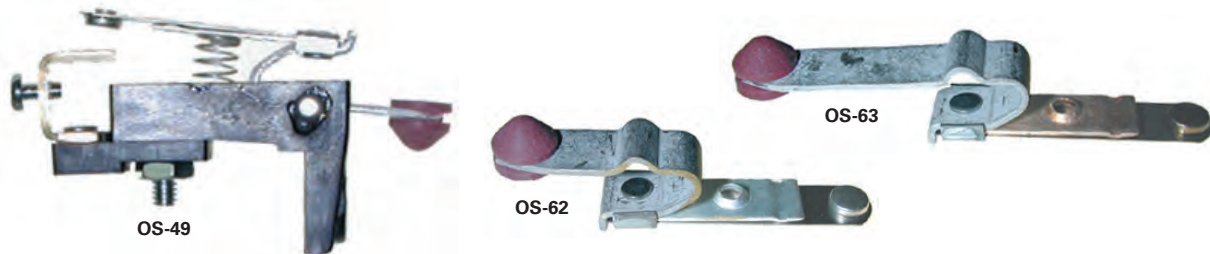
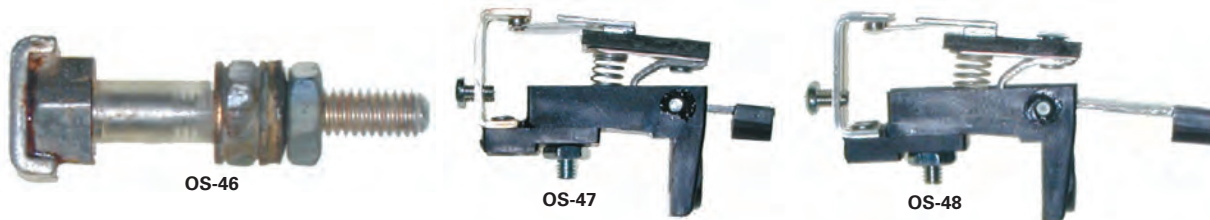

S.E.E.S. #	O.E.M. #	Description
OS-46	6850F1	Contact
OS-47	A6839G1	Leveling switch with short cam arm
OS-48	A6839G3	Leveling switch with long cam arm
OS-49	A6839E1	Door zone contact with short cam arm
OS-50	A6839E2	Door zone contact with long cam arm
OS-62	150P37	Contact assembly, short arm for OS-49
OS-63	150P41	Contact assembly, long arm for OS-50
OS-51	6839J1	Brush switch with fibre cam and shunt, double unit
OS-52	297B1	Selector tape, perforated, polished spring steel, cut to your specified length
OS-52A	VP741965	Clip, splice for selector tape
OS-52B	297B2	Selector Tape, 1" Wide, Plain no perforations, for Otis Selectors
OS-52C	AAA00279, AAA001	Selector Tape, 2" Wide, for Otis SPT Floating Tape Device
OS-52D	AAA297AV1	Selector Tape, 3-15/16" Wide Otis AAA22439AAF Application
OS-53	7042A1	Toggle switch for position indicator
OS-54	6839W1	Brush switch assembly used for 6850 selectors, 1-7/8" overall length
OS-55	6839H1, 6850	Brush switch assembly used for selectors 6850

Selector Parts



OS-56



OS-57



OS-58



OS-65



OS-64



OS-68



OS-66



OS-67



OS-69A



OSB-001



OS-69



OS-200



OS-70



OS-70A



OS-201



OS-202



OS-203

S.E.E.S. #	O.E.M. #	Description
OS-56	6482C2	Brush plunger, carbon contact assembly
OS-57	A151C2	Contact with carbon tip for OS-56 assembly
OS-58	181874	Floor bar assembly with silver contact
OS-65	VP-730550	Selector cable, (10 conductor) cloth covered, cut to length
OS-64	127VB132	Leveling washer, stainless steel
OS-68	129BT1	Flexible washer, 1-1/2" O.D. x 1" I.D.
OS-66	6809C1	Door zone switch
OS-67	156F2	Carbon contact, 4" L
OS-69	400DR2	Selector core and rod
OS-69A	465BG1	Bushing for 400DR2
OSB-001		Otis Safety Bushing, 1.5" O.D. x .555" I.D. x 1" L, 80 Duro
OS-70	A6333E1	Selector motor, 60 VDC
OS-70A	J0240A1	Brush, 1/4" x 5/16" x 11/16" for OS-70
OS-200	AAA3855V1	Guide, for Selector Tape
OS-201	288TF4	Lever, with Bushing
OS-202	494JY1	Shaft Extension, 1/4" x 5/16" x 11/16" for OS-70
OS-203	AAA27076AU1	Switch Kit, 1/4" x 5/16" x 11/16" for OS-70

Safety Edge Components

S.E.E.S. #	O.E.M. #	Description
ODO-1A	177AR1	Micro Switch for safety edge
OSE-2	6993D1 & D2	Replacement Boot for safety edges, 3-1/4" W x 83-1/4" L

See MIS-SE-5 and Universal Safety Edge Replacements starting on page 256.

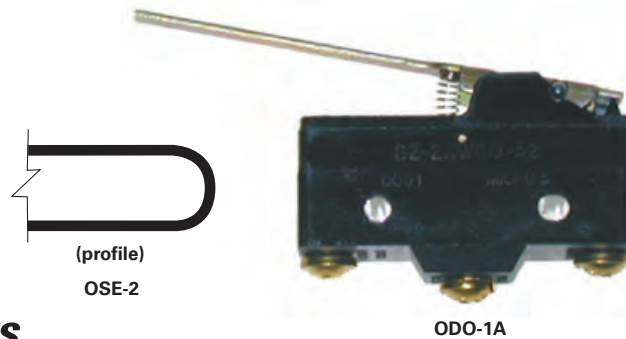

Miscellaneous Components

Washers, Nuts and Pins

BRASS JAM NUT

S.E.E.S. #	Description
BJN-1	Jam nut, 10 - 32
BJN-2	Jam nut, 1/4 - 20
BJN-3	Jam nut, 5/16 - 18
BJN-4	Jam nut, 3/8 - 16
BJN-5	Jam nut, 1/2 - 13
BJN-6	Jam nut, 5/8 - 11



BJN-1 thru BJN-6



BW-1 thru BW-4

BRASS WASHER

S.E.E.S. #	O.E.M. #	Description
BW-1		Washer, 1-1/4" O.D. x 9/16 I.D. x 3/32" thick
BW-3	133A7	Washer, 7/8" O.D. x 11/32" I.D. x 1/16" thick
BW-4		Washer, 9/16" O.D. x 1/4" I.D. x 1/32" thick
OWS-200	133E23	Washer, for Wedge Socket .78" I.D. 3.5" O.D.

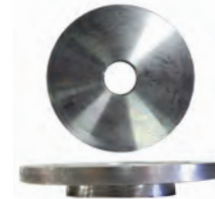

OWS-200

BRASS HINGE PIN

S.E.E.S. #	Description
BHP-1	1/2" Diameter x 4" L
BHP-2	3/8" Diameter x 4" L



BHP-1 thru BHP-2



ODP-1 thru ODP-5

Distance Pieces

S.E.E.S. #	O.E.M. #	Hex Size
ODP-1	133615	1/2" x 3-1/8" x 3-1/4"
ODP-2	127782	1" x 2-1/8" x 3-1/2"
ODP-3	126229	7/8" x 1-5/8" x 3-1/2"
ODP-4	129422	1/2" x 1-7/16" x 3-1/4"
ODP-5	118716	5/8" x 1" x 3-1/4"

Couplings

S.E.E.S. #	O.E.M. #	Description
OM-3		Sureflex pump coupling, 2-3/4" O.D. x 1-3/4" I.D. x 1-9/16" L
OM-3A		Sureflex pump coupling, 4" O.D. x 2-3/4" I.D. x 2-3/16" L
OMP-001	ABA215BX1	Coupling, 3/8" x 3/8"
OMP-001A	ABA215BX2	Coupling, 1/4" x 1/4"



OM-3, OM-3A



OMP-001

Otis Seals & Packing

S.E.E.S. #	O.E.M. #	Description
OPAC-001	AAA182AN1	Packing Kit, 2-7/8", Otis Holeless, Mfg. Prior to 2000
OPAC-002	AAA182AN2	Packing Kit, 3-15/16", Otis Holeless, Roped, Mfg. After 2000
OPAC-003	AAA182AN11	Packing Kit, 4-7/16", Otis Holeless, Roped, Mfg. After 2000
OPAC-004	AAA172SV1	Wiper Ring
OPAC-005	AAA182AN9	Packing Set, 6-1/2" Diameter Plunger for Welded Head Cylinder
OPAC-006	AAA182AN12	Packing Set, 5-1/2" Otis Holeless Roped, Mfg. After 2000
OPAC-007	AAA182AN3	Packing Set, 3-15/16" Otis Welded Head, Mfg. After 1991



OMP-001A

Machine Parts and Miscellaneous Components

Seals



PAC-38 thru PAC-38H



OWPAC-32A



OWPAC-34



OM-1A

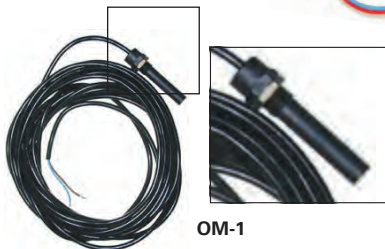

OM-1



OM-4 thru OM-4D

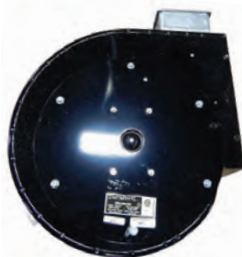

OMP-002



OM-5

S.E.E.S. #	O.E.M. #	Otis Worm Gear Seals	Seal Dimensions
PAC-38	182A4	Packing Worm Shaft	1 - 7/8" x 3-1/8" x 2-1/16"
PAC-38A	182A3	Packing Worm Shaft	1 - 9/16" x 2-9/16" x 1-11/16"
PAC-38B	182A5	Packing Worm Shaft	2 - 1/8" x 3-3/8" x 2-5/8"
PAC-38C	182A6	Packing Worm Shaft	2 - 1/4" x 3-1/2" x 2"
PAC-38D	182A14	Packing Worm Shaft	1 - 7/16" x 2-7/16" x 1"
PAC-38E	182A15	Packing Worm Shaft	1 - 9/16" x 2-9/16" x 1-1/4"
PAC-38F	182A17	Packing Worm Shaft	1 - 7/8" x 3-1/8" x 1-11/16"
PAC-38G	182A18	Packing Worm Shaft	1 - 7/8" x 3" x 2-5/8"
PAC-38H	182A19	Packing Worm Shaft	2 - 1/2" x 3-3/4" x 1-7/16"
OWPAC-32	33D26, 1R019-06	Worm Gear Seal, Split	3" x 4-1/2" (for 29 CT Machine)
OWPAC-32A	33D26, 1R019-06	Seal Kit w/ retaining plate	3" x 4-1/2" (for 29 CT Machine)
OWPAC-33	33D29, 1R020-06	Worm Gear Seal, Split	2" x 3" (for 22 CT Machine)
OWPAC-34	9726834	Locking Tab Washer	1" I.D.

S.E.E.S. #	O.E.M. #	Description
OM-1	F0177BP1	Hatch Proximity Switch Interrupter for LRV
OM-1A		Switch, Magnetic Reed 100 VDC, SPDT N.C.

Brake Cushions, Bronze Bushings

S.E.E.S. #	O.E.M. #	Description
OM-4	335W1	.75" O.D. x 1" L
OM-4A	321CJ1	1.125" O.D. x .75" L
OM-4B	321CJ4	1.475" O.D. x 1.12" L
OM-4C	321CJ3	1.398" O.D. x 1.13" L
OM-4D	321CJ2	1.875" O.D. x 1.62" L

Sheave Liners

S.E.E.S. #	O.E.M. #	Description
OM-251BT21	251BT21	Sheave Liner, Smooth 22.5" Sheave, 1/2" Ropes for 215DT

Blower

S.E.E.S. #	Description
OMP-002	Blower, 115V, AAA24720D1

Micro Switch

S.E.E.S. #	Description
OM-5	Micro Switch, 177AP1

■ OM-2BT1 thru OM-2BT17 for 1/2" rope.
BV series for 5/8" rope available upon request.

Wheels and Rollers



Hanger Rollers

S.E.E.S. #	O.E.M. #	Description
OW-1	456DH1	Door Hanger Roller , 3-3/8" O.D. x 13/16" poly tire with eccentric, 1/2" NF threaded shaft
OW-1B		Hanger Roller , 3-3/8" O.D. Flat/Radius, with OW-13B
OW-1BA		Hanger Roller , 3-3/8" O.D. Flat/Radius, Roller Only
OW-1C		Hanger Roller , 3-3/8" O.D. Flat/Radius, with Shaft, metric (M8)
OW-1D	456EW1, 456EW2	Hanger Roller , 3-3/8" Flat/Radius with eccentric shaft, 1/2-20 Thread
OW-1E	AAA456YA1,	Hanger Roller , 3-3/8" Flat/Radius with eccentric shaft, metric (M12)-AAA456YA3
OW-1E-A		Hanger Roller , 3-3/8" Flat/Rad with Eccentric Shaft Reversed
OW-1S	O403X	Hanger Roller , 3-3/8" O.D. Steel, Flat Track with eccentric
OW-40		Hanger Roller , 3-3/8" Poly 6203 with Eccentric Shaft 7/16-20
OW-40A		Hanger Roller , 3-3/8" Poly 6203 with Straight Shaft 7/16-20
OW-2	456WV1	Door Hanger Roller , 3-1/4" O.D. x 11/16" with .9841" bore I.D., polyurethane tire
OW-11	O-401	Door Hanger Roller , 3-1/4" O.D. x 11/16" 1/2" I.D. aluminum with polyurethane tire
OW-11S	A456WV1	Door Hanger Roller , 3-1/4" O.D. x 11/16", 1/2" I.D. steel roller with polyurethane tire
OW-12	456CX4	Door Hanger Roller , 3-3/8" O.D. x 13/16", .7874 bore I.D., with 11/32" radius on concave polyurethane tire surface
OW-12B		Eccentric Shaft for OW-12 door roller, 1/2" NF threaded
OW-12A		Door Hanger Roller , 3-3/8" O.D. x 13/16", .7874" I.D., all steel construction for flat track
OW-12C		Door Hanger Roller , 3-3/8" O.D. x 13/16", .7874" I.D., aluminum with polyurethane tire for flat track
OW-12S		Door Hanger Roller , 3-3/8" O.D. x 13/16" .7874" I.D., steel with polyurethane tire for flat track
OW-13	O-404	Hanger Roller , 2-3/4" O.D. x 3/4" thick, .7872" bore, steel, for OW-23
OW-13A	O-404P, 456CC2	Hanger Roller , 2-3/4" O.D. x 11/16" thick, polyurethane, for OW-23
OW-13AW		Hanger Roller , 2-3/4" O.D. Flat track (wide), .7874" I.D.
OW-13B	77RK1	Eccentric Shaft for OW-13 roller
OW-13C		Hanger Roller Steel , 2-3/4" O.D. w/ Eccentric Shaft OW-12B
OW-18	O-402, A456EA1	Steel Hanger Roller for 6178A assembly 3-1/4" O.D. x 11/16", bore 1/2"
OW-32		Hanger Roller Steel , 70mm x 14mm x 8mm



OW-13AW



OW-13C



OW-18

Wheels and Rollers

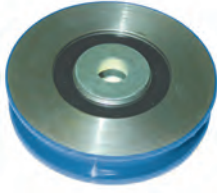

OW-18A



OW-23



OTHR-1



OTHR-2



OTHR-3



OTHR-4



OTDH-2



OTDH-1



OTWH-1



OW-202



OW-3



OW-3A



OW-4

Hanger Rollers & Assemblies

S.E.E.S. #	O.E.M. #	Description
OW-18A	A456EA1	Hanger roller, 11/16" wide, 3-1/4" O.D. for 6178A assembly steel with polyurethane tire
OW-23	389J2	Hanger assembly for Type B & 7087
OTHR-1		Roller for Hanger Assembly 86mm O.D. x 20mm W, bearing 6204 ID: 20mm
OTHR-2		Roller, Hanger, 90mm x 18mm
OTHR-3		Hanger assembly, Hanger
OTHR-4	XAA520C1	Roller for hanger, 84 mm, 3.3" O.D.
OTHR-6	FOC2215Z137	Orly Roller, Door hanger, D50/40mm x 15mm M10 Eccentric Stud
OTWH-1		Sheave
OTDH-1		Hanger assembly, Car
OTDH-2		Hanger assembly, Landing
OW-202	389P2	Bracket, for Hanger Assembly
OW-202A	389P4	Hanger Assembly, 7087 Hangers 3" Run Diamond Eccentric Upthrust.
OW-203	77RK1	Pin for Roller
OW-206L		Hanger Assembly, L.H. Type I, 1/2" Bolts - 2.5" Spacing
OW-206R		Hanger Assembly, R.H. Type I, 1/2" Bolts - 2.5" Spacing
OW-207L		Hanger Assembly, L.H. Type II, 1/2" Bolt - 4.63" Spacing
OW-207R		Hanger Assembly, R.H. Type II, 1/2" Bolt - 4.63" Spacing

Rollers

S.E.E.S. #	O.E.M. #	Description
OW-204		Roller, 3-3/8" O.D. (3" Run Dia) .75" W, with 1/2-20 Ext Shaft
OW-205		Roller, Convex Tire 2.20" O.D. x 7/8" W x .370" I.D.
OW-3	456AK2	Roller guide wheel, 3-3/4" O.D., polyurethane tire, sealed maintenance free bearing with 5/8" shaft
OW-3A	A59J1	Pivot bolt for pivot arm
OW-4	456DN1	Roller guide wheel, 3" O.D., 3/8" flat polyurethane tire face, with 1/2" NC threaded eccentric shaft 1" L, 1/4 spacer
OW-4A	456DN2	Roller guide wheel, shaft 1-3/4" L, 1/2" spacer

Rollers and Slide Guides

S.E.E.S. #	O.E.M. #	Description
OW-4B	456DN3	Roller guide wheel , shaft 2-3/8" L, 7/8" spacer, O.D. 3"
OW-17	456CE4	Door roller with eccentric shaft, 2" O.D. x 9/16" with threaded shaft 1/2-20
OW-19	B6037B6, B6037B1	Hanger assembly for hoistway, includes heavy bracket, rollers and wiper
OW-19A	456G1, 456EP2	Door roller kit , bolt and washer. Replacement roller kit for OW-19. 2-1/4" O.D., 3/4" I.D.
OW-19B	456G1-POLY	Door Roller Kit , Urethane Tire with Bolt and Washer
OW-20	456FC1	Hanger roller , LRV, 2" O.D.
OW-21	A6037D1	Wheel , 3.15" O.D., .587" W, 1/2" face, .875" I.D., aluminum
OW-24	HT200983-1	Tachometer drive wheel . Velocity transducer wheel for geared & gearless equipment, 4.332" O.D. x .490", tapered I.D.
OW-28		Roller , Guide Roller 4-7/8" O.D. 1-1/16" Wx.7874" I.D. (2x6204)
OW-29		Roller , Guide Roller 6-5/16" O.D. 1-1/4" Wx.9843" I.D. (2x6205)
OW-30B	KAA25830A2	Roller Guide Assy , 4.92" O.D., Bottom for 2 & 1-1/2# Rail, Each
OW-30H	KAA25830A402	Service Kit , postwise upper pivot
OW-30G	KAA25830A401	Service Kit , postwise lower pivot
OW-30I	KAA90A1	Spring , for Roller Guide
OW-30A	KAA25830A1	Roller Guide Assy , 4.92" O.D., Top for 2 & 1-1/2# Rail, Each
OW-30F	KAA25830A403	Service Kit , Front to Back Roller Bolt
OW-30E	KAA456K1	Roller , 125mm (4.92") for Roller Guide Assembly
OW-30C	KAA25830A3	Roller Guide Assembly , Set of 4 for 2 & 1-1/2# Rail
OW-30D	KAA384C1	Guard , for Guide Assembly
OW-30J	KAA133A1	Spring Seat , for Roller Guide

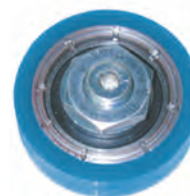

OW-17



OW-19



OW-19A



OW-19B



OW-20



OW-21

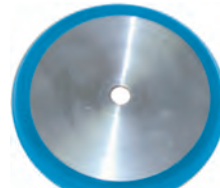

OW-24



OW-28



OW-29

S.E.E.S. #	O.E.M. #	Description
OTDV-4		Roller for Door Vane 30mm x 8mm ID: 6mm 6g-M8
OTDV-5		Roller for Door Vane 37mm x 20mm ID: 12mm
OTGS-1	XAA237D	Guide Shoe Inside , CS
OTGS-2	XAA380N1	Guide Shoe , 120mm x 16mm
OTGS-3	XAA24161A1	Guide Shoe , with spring
OTGS-6		Cushion for guide shoe insert
OTGS-7		Guide Shoe Insert , 146mm x 35mm x 6mm
OTGS-12		Guide Shoe Groove , 150mm x 48mm
OTGS-13		Guide Shoe Groove , 150mm x 48mm
OTGS-14		Roller , for Guide Shoe 114mm x 36mm, bearing 6203
OTGS-19		Guide Show Insert , 98mm x 32mm x 10mm



OTDV-4

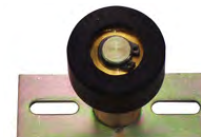

OTDV-5



OTGS-6



OTGS-7



OTGS-12



OTGS-13



OTGS-14

Rollers and Slide Guides



OTGS-15



OTGS-16



OW-7



OW-7A



OW-7J



OW-7H



OW-7P



OW-200



OW-7E-RBK-A



OTGS-19



OTGS-20



OTGS-21



OTGS-22



OW-7B



OW-7C



OW-7D

S.E.E.S. #	O.E.M. #	Description
OTGS-15		Roller, for Guide Shoe 160mm x 30mm, bearing 6203 ID: 17
OTGS-16		Roller, for Guide Shoe 114mm x 36mm, bearing 6203 with Shaft
OTGS-19		Guide Shoe Insert, 98mm x 32mm x 10mm
OTGS-20		Guide Shoe Insert, 3 in 1, 200mm x 25mm x 6mm
OTGS-21		Guide Shoe Insert, 200mm x 30mm x 6mm
OTGS-22		Guide Shoe Insert, 3 in 1, 215mm x 42mm x 4mm
OTGS-200	380AT1	Gib, for Guide Shoe, cast iron, 12" long
OTGS-201	380BP1	Gib, for Guide Shoe, cast iron, 8.525" L, for # 3/4 rail
OTGS-202	6079	Gib, for Guide Shoe, cast iron, 8.5" L, for 5/8" thick rails

S.E.E.S. #	O.E.M. #	Description
OW-7	456CL4	Roller guide wheel, 7-7/8" O.D. x 1-1/2" Poly tire w/ sealed maintenance free bearing, hub extends past tire width on shaft side, after Dec. '62
OW-7A	59P2	Bolt, pivot, for 7-7/8" roller guide assembly
OW-7B	335H1	Bushing, brass, for roller guide assembly
OW-7C	B288CK1	Lever for 7-7/8" roller guide assembly, R.H.
OW-7D	B288CK2	Lever for 7-7/8" roller guide assembly, L.H.
OW-7E	6261C1	Roller Guide Assembly, 7-7/8" O.D. for #1 & #1-1/2 Rail, Top
OW-7E-RBK		Rebuild Kit for OW-7E, Less the Base and Cover
OW-7E-RBK-A		Rebuild Kit for 7-7/8" Roller Guide From 1947-2000
OW-7F	6261C4	Roller Guide assembly, 7-7/8" O.D. for #1 & #1-1/2 Rail, Bottom
OW-7G	6261C400	Hardware Kit for Roller Guide OW-7E and OW-7F
OW-7H	6261C4	Roller Guide Assembly, 7-7/8" O.D. for #1 & #1-1/2 Rail, Bottom
OW-7I	456CL4/O423	Roller Guide wheel, 7-7/8" O.D. x 1-1/2" W with shaft, HD 90 Duro
OW-7J	O421X	Otis Bolt and Bushing, assembly with hardware
OW-7K	F6261C2	Roller Guide Assembly, 7-7/8" O.D. for #3/4 Rail, Top
OW-7L	F6261C5	Roller Guide Assembly, 7-7/8" O.D. for #3/4 Rail, Bottom
OW-7M	F6261C3	Roller Guide Assy, Counterweight, 7-7/8" O.D. for #1 and #1-1/2 Rail, Top
OW-7P	90BN1	Spring for OW-7E and OW-7F
OW-7Q	149AG4	Spring Anchor for OW-7E and OW-7F
OW-7R		Felt Wick for Roller Guide Pivot Bushing 1/4" O.D. x 1/2" Long Soft Felt
OW-200	A395D2	Lever for Roller Guide
OW-200A	B288LJ2	Lever for Roller Guide
OW-200C	A288LM2	Lever
OW-201	A288RL2	Lever for Roller Guide
OW-211	AAA456YL1	Roller, 200mm (7.875")



OW-200A



OW-200C



OW-201

Rollers and Slide Guides



S.E.E.S. #	O.E.M. #	Description
OW-4C	90CM1	Compression Spring for 6261AB
OW-8	456CM4	Roller guide wheel , 4-7/8" O.D. x 2-5/8" overall hub width. Polyurethane tire, 1" shaft, maintenance free sealed pump shaft bearing
OW-9	456CN4	Roller guide wheel , 3-3/4" O.D. x 7/8" Polyurethane tire, 5/8" hub, 1" shaft, maintenance free sealed pump shaft bearing
OW-9A	6261P1	Roller guide assembly complete , with three OW-9 rollers, 3-3/4" O.D.
OW-9AB	KAA25830B5	Roller Guide Assy , New Style 76mm Wheel, set of 4, hardware included
OW-9AD	KAA25830B2	Roller Guide Assembly , 3" O.D., Bottom for 2# Rail, Each
OW-9AC	KAA25830B1	Roller Guide Assembly , 3" O.D., Top for 2# Rail, Each
OW-9AE	KAA25830B3	Roller Guide Assembly , 3" O.D., Top for 1-1/2# Rail, Each
OW-9AF	KAA25830B4	Roller Guide Assembly , 3" O.D., Bottom for 1-1/2# Rail, Each
OW-9AG	AAA384AHH1	Guard , for 3" Guide Assembly
OW-9AH	KAA2v5830B401	Screw , for 3" Roller Guide Assembly
OW-9AI	90BC12	Roller , 3" (76mm) O.D. for Roller Guide
OW-9AJ	KAA25830B401	Arm lever , M5x10 for Guide
OW-9AK	90BC12	Spring , Tension Spring, Double
OW-9AL	91B19	Spring , Compression Spring, for OW-9A
OW-9A-RBK		Rebuild Kit for OW-9A, Less the Base
OW-9A-RBK-A		Rebuild Kit , 3-3/4" Roller Guide From 1962-1990
OW-9B	288LM2	Arm Lever , roller guide assembly, 3-3/4"
OW-9C	288LL2	Post , arm lever for roller guide assembly, 3-3/4"
OW-9D	288LL2	Pivot Pin , for OW-9A Roller Guide Assembly
OW-9E		Bumper , for OW-9A
OW-10	456CV4	Roller guide wheel , 10" O.D. x 1-1/2" Polyurethane tire, shaft with maintenance free sealed bearing
OW-10A		Spring , Replacement for OW-10
OW-10B	59BR2	Pivot bolt , for roller guide assembly
OW-10C	456ACH1	Roller Guide Wheel , 10" OD x 1.5" W x .20 Face, with Shaft
OW-10D	B261AM3	Roller Guide Assembly , 10" O.D. for #1 Rail, Top
OW-10E	B261AM4	Roller Guide Assembly , 10" O.D. for #1 Rail, Bottom
OW-10F	B261AM5	Roller Guide Assembly , 10" O.D. for #1/2 Rail, Top
OW-10G	B261AM6	Roller Guide Assembly , 10" O.D. for #1/2 Rail, Bottom
OW-10H	B6261AM1	Roller Guide Assembly , 10" O.D. for #3/4 Rail, Top
OW-10K	B261AM7	Roller Guide Assembly , 10" O.D. for #0A Rail, Top
OW-10L	B261AM8	Roller Guide Assembly , 10" O.D. for #0A Rail, Bottom
OW-210	616AA1	Roller Guide Assembly , 3" Round Rail

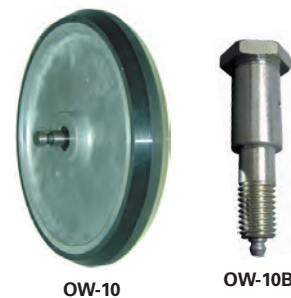

Rollers and Slide Guides

S.E.E.S. #	O.E.M. #	Description
OW-15	456AJ2	Roller Guide Wheel , 7-7/8" O.D. x 1-1/2" Polyurethane tire with sealed maintenance free bearing with shaft, hub extends past tire width on side opposite shaft, 1941 thru 1962
OW-15H	456AJ2/0421	Roller Guide Wheel , 7-7/8" O.D. x 1-1/2" W w/ shaft, HD 90 Duro
OTWH-8		Roller for Hanger Nylon Hub 76.2mm x 21.4mm, ID: 19.1mm
OTWH-11		Roller , 3-1/8" O.D. x .79" (80mm x 20mm) Bearing 6204
OTLO-9		Roller for Door Lock 52mm x 20mm, bearing 6201, ID: 12mm
OTLO-10		Roller for Door Lock for GS09 37mm x 20mm, ID: 12mm
OTLO-13		Door Lock Contact for Otis Elevator
ORG-001	380BS2	Insert , Otis 3" round tube rail gib



OW-15



OW-15H



OTWH-8



OTLO-9



OTLO-10



ORG-001



PAYNE / O. THOMPSON

QUICK LOCATOR GUIDE

Belts	790
Car Signal Components	786
Key Switches and Keys	786
Emergency Stop Switch	786
Pushbutton Assemblies	786
Coils	786-787
Contacts	787-788
Carbon Contacts	787-788
Copper Contacts	787-788
Rectifiers	791
Relay Components	788-791
Carbon Contacts	788-791
Copper Contacts	788-791
Seals	790
Selector Parts	791
Timer Kit	791
Wheels and Rollers	791

Car Signal Components



PB-1 with back view



PB-2-1



PB-2C



PB-2A-DOOR OPEN



PKS-1



PKS-2



PKS-3



PKS-4



PKS-6



PKS-8-1A



PKS-8



PKS-10

Coils



PC-8



PC-9



PC-1



PC-2



PC-3



PC-4



PC-18



PC-19



PC-20



PC-23



PC-22

S.E.E.S. #	O.E.M. #	Description
PB-1	M-2415E	Stop Switch , emergency stop switch marked "ON/OFF"
PB-1A	M-2415EA	Stop Switch and alarm 1N.O.,1N.C.
PB-2-	M-2366	Pushbutton assembly , specify button marking, i.e. PB-2-1
PB-2A-		Button , specify marking, i.e. PB-2A-DOOR OPEN
PB-2C		Cap , clear for button PB-2A series
PKS-1	M3137-C	Key Switch , Fire Service, car, 6330 key
PKS-1A	6330	Key , 6330, barrel type for PKS-1 & 2
PKS-2	M3035-H	Key Switch , Fire Service, hall, 6330 key
PKS-3		Key Switch , Independent service, 6304 key
PKS-3A	6304	Key , 6304, barrel type for PKS-3
PKS-4	4079-70	Key Switch , Off, On, spring loaded, 6304 key
PKS-6		Key Switch , Off, On, key removable in both positions, 6304 key
PKS-6A		Key Switch , Off-On DPDT 2 Pos, Rmv 2
PKS-8		Key Switch Assy , Inspection Off-On, 6305 key
PKS-8A	6305	Key , 6305 key used for inspection
PKS-8-1A	4079DC	Key Switch , 2 Position, 2 Key Pull "OFF-ON", 6305 key
PKS-9A	6315	Key Payne Fire Service 6315
PKS-10		Key Switch , Off/On 2 Pos Remove OFF, 6304
PKS-11		Key Switch , Insp Off/On 2 Pos 2Kp with 6304 Key

S.E.E.S. #	O.E.M. #	Description
PC-1	N-133	220 VDC, 120 Ohms
PC-2	L-573	70 VDC, 100 Ohms
PC-3	C-583	220 VAC, 1200 Ohms
PC-4	V-225	110 VDC, 800 Ohms
PC-5	V-224	175 VDC, 1000 Ohms
PC-6	N-146	220 VDC, 200 Ohms
PC-7	N-148	208 VDC, 90 Ohms
PC-8	KD-208	220 VAC, 1200 Ohms
PC-9	KD-119	220 VDC, 1200 Ohms
PC-10	C-478	600 Ohms*
PC-11	C-499	8 Ohms*
PC-12	C-519	3 Ohms*
PC-13	C-53	50 Ohms*
PC-14	C-550	2000 Ohms*
PC-15	N-375	110 VDC, 875 Ohms
PC-16	N-381	220 VDC, 400 Ohms
PC-17	N-559	550 VAC, 2000 Ohms
PC-18	N-571	220 VDC, 5000 Ohms
PC-19	MA-125	208 VAC, 1500 Ohms
PC-20	C115	Dual 20 Ohms 1 & 2 / 27 ohms 3 & 4
PC-21	MA-11	220VAC, 2.0 Ohms "M" Machine Brake
PC-22	C-338	Coil C-338
PC-23	C-344	Coil C-344

*Voltage varies.

Coils

S.E.E.S. #	O.E.M. #	Coil Description
OTC-1	108, 250003	80 ohm 40 VDC
OTC-2	111, 250004	150 ohm 60 VDC
OTC-3	112, 250005	1800 ohm 70 VDC
OTC-4	114	2700 ohm 65 VDC
OTC-5	N-136, 250009	900 ohm 110 VDC
OTC-6	142, 250011	2540 ohm 230 VDC
OTC-6A		1575 ohm 142 VDC
OTC-6B		VDC
OTC-7	N-143, 250012	3670 ohm 230 VDC
OTC-8	146, 250013	5670 ohm 230 VDC
OTC-9	241, 250023	2100 ohm 230 VDC
OTC-11	#239	850 ohm 160 VDC
OTC-12	#211	24 ohm 220 VAC
OTC-13	#550	4100 ohm 550 VAC



■ OTC-1 thru OTC-8
2" O.D. x 1-3/16" H x 7/8" I.D., 2-3/8" C/C mounting holes

■ OTC-9
2-1/4" O.D. x 2-3/8" H x 1-3/32" I.D., 2-3/4" C/C mounting holes

Contacts

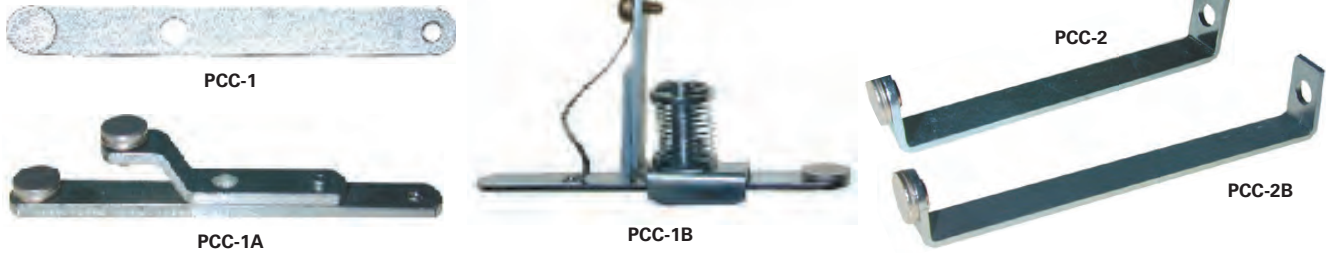

S.E.E.S. #	O.E.M. #	Description
PCC-1	M-1607	Contact finger, 3-3/8" L x 3/8" W
PCC-1A	M1610	Finger contact assembly with auxiliary contact
PCC-1B	M1656	Contact assembly
PCC-1C	M1609	Contact finger
PCC-1D	M1616	Contact, stationary, 2-3/8" L for PCC-1B
PCC-2	M1617	Contact, 2-7/8" L, with 3/8" diameter contact face
PCC-2B	M1619	Contact, 3-3/8" L, with 3/8" diameter contact face
PCC-3	K-2839	Carbon contact, 1-3/16" diameter x 3/4" L (makes with PCC-4)
PCC-3A	K-1415	Carbon contact, 7/8" diameter x 3/4" L (makes with PCC-4A)
PCC-4	K-2840	Copper contact, head 1-1/4" dia. x 5/16". Stem 5/16" dia. x 1-3/8" L
PCC-4A	K-2587	Copper contact, head 1" dia. x 1/4", stem 1/4" dia. x 1-3/8" L
PCC-6	K-1786	Copper contact, head 1-5/8" x 1-3/8", stem 3/8" diameter x 2" L (makes with PCC-7)
PCC-6A		Contact insulator, PCC-6 Contact Insulator K54
PCC-7	K-1399	Carbon contact, 1-1/4" x 1-1/2"





Contacts

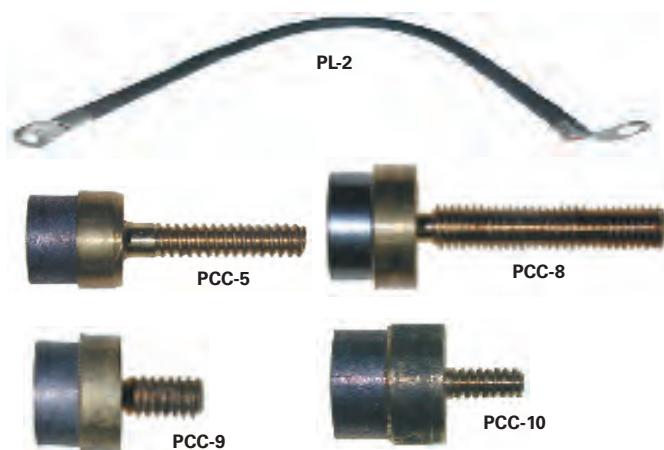
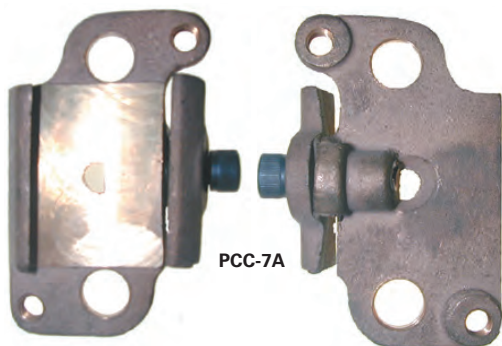

S.E.E.S. #	O.E.M. #	Description
PCC-7A	P1627-8	Carbon Holder , top clamp for PCC-7 carbon
PCC-7C	M429	Shunt , Braided for PCC-7B O
PL-1	M641	Lead , 6-1/4" for O & S relays,
PL-2	M208	Lead , 16" with one flat eyelet, and one right angle eyelet
PCC-5	M-394	Carbon contact , 5/8" diameter x 1" L, stem 1/4" diameter
PCC-8	M991	Contact assembly with 7/16" carbon, stem 10-32 x 1" L
PCC-9	M427	Contact assembly with 7/16" contact, 3/4" L stem 10-24 x 3/8" L
PCC-10	M-14	Contact assembly with 5/8" face diameter x 7/8" L, stem 10-24 x 3/8" L

Relay Components

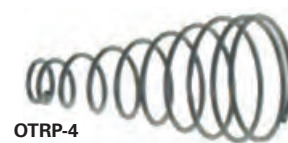

Type "F" Contact



S.E.E.S. #	O.E.M. #	Description
OTRP-1	EF-6	Carbon contact , 1/2"
OTRP-1A	A09021	Carbon contact , 3/8", EK6
OTRP-1B	EEA09030	Contact Assy , Finger 3/8" W 2-1/8" L with Silver Contact
OTRP-1P	FK-7, A09106	Post Assembly , FK-7
OTRP-2	FF-7	Contact post , 3" L, stud screw .18" dia.
OTRP-3	F-30	Copper contact , 5/8" x 1/8"
OTRP-4	F-27	Spring Kit
OTRP-5	EK-23	Shunt , 4.75" L
OTRP-32	SK30F, F-30A	Copper Contact Finger , 1/2" W, 5/8" O.D.
OTRP-34	SK37	Copper Contact , stationary, 90° angle w/ 1/4" diameter hole



Relay Components



OTRP-6



OTRP-7



OTRP-8



OTRP-9

Type "G" Contact

S.E.E.S. #	O.E.M. #	Description
OTRP-6	G-32	Carbon contact, 5/8" x 1/2"
OTRP-7	F-33	Carbon holder
OTRP-8	G-30	Copper contact, 3/4" x 1/8"
OTRP-9	G-19	Spring Kit
OTRP-30	G6, 710106	Hinge Pin, G-6

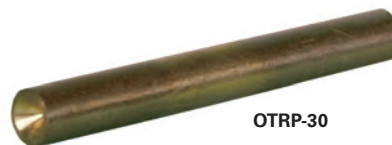

OTRP-30



OTRP-10

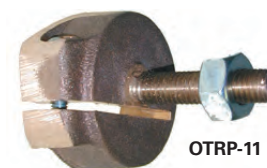

OTRP-11

Type "H" Contact

S.E.E.S. #	O.E.M. #	Description
OTRP-10	H-31	Carbon contact, 1-1/2" diameter
OTRP-10A	A09021	Contact, Copper 1-3/4" Dia. 3/8"
	HM-28-2	Thick 3/8" Diameter Stem
OTRP-11	H-32	Carbon holder
OTRP-12	K38-2	Contact post, 3-1/2" L
OTRP-13	K-30	Contact spring
OTRP-14		Copper contact, 1-3/4" x 1/4"
OTRP-14A	HK-23	Replacement shunt, for OTRP-18



OTRP-12



OTRP-13



OTRP-14



OTRP-14A



OTRP-15



OTRP-16



OTRP-17



OTRP-18



OTRP-19

Type "J" Contact

S.E.E.S. #	O.E.M. #	Description
OTRP-15	K-35	Carbon contact, 1-1/8"
OTRP-15A	KM-33-2	Contact, Copper 1-1/4" Diameter
		3/8" Thick Used In KL-HM Relay
OTRP-16	K-36	Carbon holder
OTRP-17	K-38-2	Contact post, 4-3/4" L
OTRP-18	A09058	Contact blade & shunt
OTRP-19	K-30	Spring Kit
OTRP-20	K-33	Copper, 1-1/4" x 3/16"
OTRP-28		Copper, round, 1-3/4" x 3"
OTRP-31	K8, 710114	Hinge Pin, K-8



OTRP-20



OTRP-28



OTRP-31



Relay Components



OTRP-21



OTRP-23

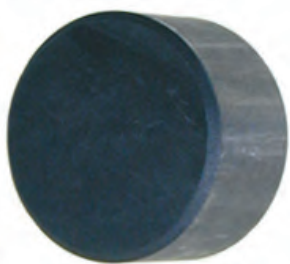

OTRP-24



OTRP-26

Type "L" Contact

S.E.E.S. #	O.E.M. #	Description
OTRP-21	CK-35	Carbon contact, 3/4" dia.
OTRP-23	CK-33	Copper contact, 1" x 3/16"
OTRP-33	278005	Coupling, 5/16" x 3/8" for encoder

Type "NC" Contact

S.E.E.S. #	O.E.M. #	Description
OTRP-24	NC-31	Carbon contact, 1-3/4" dia.
OTRP-26	H-2-1/4-28	Copper contact, 2-1/4" x 3/8"

Seals and Belts



PPAC-1



PPAC-3



PPAC-4

S.E.E.S. #	Description
PPAC-1	Seal, pedestal, for #302 Machine, 3.375" x 4.375"
PPAC-3	Seal, worm shaft for #302 Machine
PPAC-4	Seal, Worm Shaft Used On Payne 401 & 402 Machine
PBLT-1	Belt, timing belt for selector, 26" x 3/8"
PBLT-2	Belt, 23" x 3/8"
PBLT-3	Belt, 16" x 3/8"

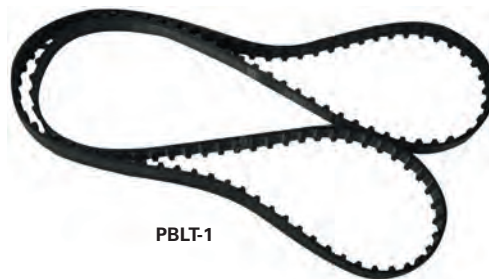

PBLT-1

Selector Parts



PS-1



PS-1A



PS-2

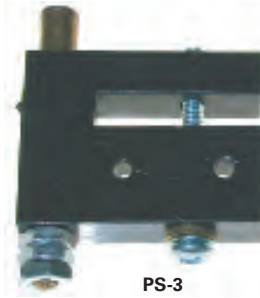

PS-3



PS-4



MIS-203



PRT-1N

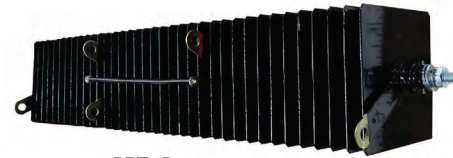

PRT-1P



PRT-2

S.E.E.S. #	O.E.M. #	Description
PS-1	K-7981	Selector tape guide, 5/8" W
PS-1A		Selector tape guide, 1" W
PS-2	M-1083	Selector contact assembly
PS-3	M-2924	Selector contact, movable
PS-4	M-2925	Selector contact, stationary
MIS-203	K7822	Rectifier, silicon, plug-in
PRT-1N	C1247	Rectifier, 36 plates, 2-5/8" negative
PRT-1P	C1246	Rectifier, 36 plates, 2-5/8" positive
PRT-2		Rectifier, 20 Plate 2" SQ, full wave 115V

Timer Kit

S.E.E.S. #	O.E.M. #	Description
PT-1	K7754, M7754	Timer Replacement kit and instructions. This timer replaces old style (obsolete)



PT-1

Wheels



MIS-187



MIS-187A



MIS-187B

S.E.E.S.#	O.E.M. #	Description
MIS-187	M1286	Roller, 3" O.D. x 1" W x .5906" I.D., two bearings
MIS-187A	M1289	Roller, 5" O.D. x 1-1/4" W x .7874" I.D., two bearings
MIS-187B	M1292	Roller, 7" O.D. x 1-1/4" W x .7874" I.D., two bearings

Tap and Drill Sizes for Numbered Machine Screws

Tap Size # Threads / Inch	Drill Sizes Inches	Drill #
0-80	0.0469	3/64"
1-56	0.0550	54
1-64 & 72	0.0595	53
2-56 & 64	0.0700	50
3-48	0.0785	47
3-56	0.0820	45
4-32	0.0820	45
4-36	0.0860	44
4-40	0.0890	43
4-48	0.0935	42
5-40	0.1015	38
5-44	0.1040	37
6-32	0.1066	36
6-36	0.1110	34
6-40	0.1130	33
8-32 & 36	0.1360	29
8-40	0.1405	28
10-24	0.1495	25
10-30	0.1570	22
10-32	0.1590	21
12-24	0.1770	16
12-28	0.1820	14
12-32	0.1850	13

Tap Inch- Threads/Inch	Drill Sizes Inches	Drill # or Letter Size
1/4"-20	0.2010	7
1/4"-28	0.2130	3
5/16"-18	0.2570	F
5/16"-24	0.2720	I
3/8"-16	0.3125	5/16"
3/8"-24	0.3320	Q
7/16"-14	0.3680	U
7/16"-20	0.3903	25/64"
1/2"-13	0.4219	27/64"
1/2"-20	0.4531	29/64"
9/16"-12	0.4844	31/64"
9/16"-18	0.5156	33/64"
5/8"-11	0.5312	17/32"
5/8"-18	0.5781	37/64"
3/4"-10	0.6562	21/32"
3/4"-16	0.6875	11/16"
7/8"-9	0.7656	49/64"
7/8"-14	0.8125	13/16"
1"-8	0.8750	7/8"
1"-12&14	0.9375	59/64"

Courtesy of ELEVATOR WORLD, INC., from Elevator Maintenance Manual. Copyright © 1999. Reprinted by permission.

SCHINDLER / WESTINGHOUSE

QUICK LOCATOR GUIDE

Belts	803
Brushes	804-809
Brush Holders	810
Capacitors	832
Car Signal Components	794-802
Gongs	802
Emergency Stop Switch	798-799
Key Switches and Keys	794-796, 800
Lantern Lens	801
Position Indicators	800
Pushbutton Assemblies	794, 799
Switches, Rocker and Reed	802
Coils	812-814
Door Parts And Equipment	815-831
Cables and Pulleys	817, 826, 829-830
Door Keys and Escutcheons	823
Door Roller Assemblies	827
Gibs, Guides	823-824
Hatch Equipment	850-853
Interlock Components	815, 818-820
Door Motors	817, 828, 830
Operators	825-828
Safety Edge Parts	821
Spirator, Reel Closer	822, 826
Track Liner	857
Electronics - Tubes, Breakers, Fans	832-833
Machine Parts	834-838
Gaskets, Seals and Bearings	834-838
Motors	828
Printed Circuit Boards	839-843
Rectifiers	832
Relays	845
Relay Components	846-850
Replacement Spring Clips	811
Resistors	844
Selector Components	851
Switches	850, 852
Transformers	855
Wheels And Rollers	855-861
Hanger Assemblies	855-857
Hanger Rollers	855-856, 858
Roller Guide Assemblies	860
Roller Guide Wheels	858



Car Signal Components



SB-1



SB-2

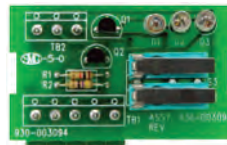

SB-3

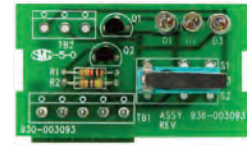

SB-4



SCH-KCY-001



SB-1BR-7



SB-5



SB-6



SB-6-VAN



SCH-KCY-002



SK-5

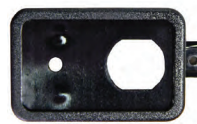

SKS-1



SKS-2



SKS-2A



SB-8



SB-1BR-B

S.E.E.S. #	O.E.M. #	Description
SB-1	8544C17G04	Button Housing , with lens
SB-1BR-	6954C71H01	Braille Plate , braille for SB-1 housing or SB-6 assembly, Stainless Steel, 1" x 1.187" (specify marking)
MIS-BR1.25-		Braille Plate , for SB-6-VAN assembly, Stainless Steel, 1.25" x 1.25" (specify marking)
SB-2	8540C58H02	Button Retainer Bracket
SB-2A	70010CSC3R	Screw , 6-32 x 1/2" Hex Washer Head, Slotted
SB-3	7283C730G02	Printed Circuit Board Assembly for pushbutton, two micro switch type
SB-4	7283C730G01, 998C278H11	Printed Circuit Board Assembly for pushbutton, one micro switch type
SCH-KCY-001	D3158-057A/AS100	Key Switch , PHII, 3 position with AS100 key
SCH-KCY-002	D3158-057B/AS100	Key Switch , PHII, 3 pos, AS100 key, per yr. 2000 code
SCH-KCY-004		Key Switch , 2 Pos, Rmv 2 with 100T Key
SCH-KCY-005		Key Switch , 2 Pos, Rmv 1 Spring Ret with OCO-1 Key
SCH-KCY-005A		Key Switch , 2 Pos, Rmv 2 with 2 OCO-1 Keys
SB-5	8544C19G01	Jewel , MT style, Fire Service Light
SB-6	8544C17G01	Pushbutton Assembly 2-SW
SB-6-VAN		Vandal Proof Pushbutton Assembly , 24V 1 N.O. SW Cont. Replaces Schindler MPH Style Buttons
SB-6-VAN-A		Vandal Proof Pushbutton , 6V-120V 1 N.O./1 N.C. Switch, White Replaces MPH Style Buttons
SB-7	6947C64G02	Stop switch assembly
SB-8	7275C63G01	Button , white
SB-10L		Schindler Button , Standard L.H. 330A
SB-10R		Schindler Button , Standard R.H. 330A
SB-11L		Schindler Button Base , L.H. 330A
SB-11R		Schindler Button Base , R.H. 330A
SB-12		Button , Hall Station White Arrow
SB-12V		Button , Hall Station Arrow, Vandal Resistant Aluminum with Jewel
SB-13		Corridor Button Base Assembly For Hall Station
SB-1BR-B		Braille , B For SB-1
SB-1BR-M		Braille , M for SB-1
SB-1BR-STAR-G		Braille , *G for SB-1

Car Signal Components

S.E.E.S. #	O.E.M. #	Description
SK-1	AS100	Key, PHI & PHII fire service key AS100
SK-2	100-T	Key, #100-T car panel key
SK-3	OCO-1	Key, Schindler OCO-1 Hoistway Access key
SK-4	OCO-4	Key, Schindler OCO-4 Industrial Service key
SK-5	H301	Key, Schindler H301 STOP-RUN key
SK-6	WD01	Key, Fire Service, WD01
SK-8	501CH	Key, Access 501CH S
SK-9	MM101	Key, General Service MM101
SK-10	J222	Key, J222
SK-11	J217	Key, J217
SK-12	AS110	Key, AS110
SK-13	LDU	Key, LDU Access
SKS-1	8544C14H01	Bezel, key switch bezel only for MTA keyswitches
SKS-1A	7254C77H18	Face Plate, Blank Black MTA keyswitch for SKS-1
SKS-2	8544C18G02	Key Switch, Fire Service, MTA PH1, 3 Pos. ON/OFF/ BYPASS, use SK-1 key, with AS100 Key
SKS-2A	8544C18G01	Key Switch, Fire Service, MTA Style, PH II, SK-1 key, 3 Pos. OFF/HOLD/ON, with AS100 Key
SKS-2B		Fire Service Key Switch, MT Style PH 1 with H341 key
SKS-2C		Fire Service Key Switch, MT Style PH 2 with H341 key
SKS-2D		Fire Service Key Switch, MT Phase I, 3 Position, Rem 2 On Off, Reset, with AS100 Key
SKS-2-FAN		Key Switch, Fan, High-Off-Low 3 Pos, Rmv 3 with USE#2 Key
SKS-2-IND-SERV		Key Switch, Ind Serv, Off-On 2 Pos, Rmv 2, UTC Key
SKS-3B		Key Switch, 2 Pos Rem 1 Momentary Off, On with OCO-1 Key



SK-1



SK-2



SK-3



SK-4



SKS-5



SK-6



SK-8



SK-9



SK-10



SK-11



SK-12



SKS-2-FAN



SKS-1A



Car Signal Components



1

S.E.E.S. #	O.E.M. #	Description
SKS-4	A5468AA101	Key Switch , Fire Service, PHI Hall, uses SK-6 Key
SKS-5	A5468A201	Key Switch , Fire Service, PHII CAR, uses SK-6 Key
SKS-5A		Key Switch , Fire Service, PH II, 2 Pos/Rem. 2 with D01 Key
SKS-6		Key Switch , 2 Position, Removal 2 Key H301
HK-1	3-40079-51	Key only for SKS-3 ACECLC332
WK-2	H200	Key , Utility Door Key #H200



2



3



4



5



6



7



8



9



10



11



13



12

Type A Hall Station

Fig.	S.E.E.S. #	O.E.M. #	Description
1	WB-1-	477C742G	Button , black square base with 1" diameter button with white marking, and clear cap (specify marking)
2	WB-2-	477C742G	Button , white square base with 1" diameter button with black marking, and clear cap (specify marking)
3	WB-6A	146A560H05	Clear cap
4	WB-6B	477C740H01	Base , Button base plate
5	WB-6E	151B605H01	Lamp socket holder
6	WB-7	569A997H01	Ferrule , Lexan
7	WB-9	151B608G01	Movable contact bridge , N.O.
8	WB-11	151B616G01	Stationary contact , N.O.
9	WB-19	577C549G01	Cover plate , 1 button, stainless steel, 3" W x 10" H. 1-1/4" dia. button hole
	WB-20	577C549G02	Cover plate , 2 buttons, stainless steel, 3" W x 10" H. 1-1/4" dia. button hole
10	WB-21	T8474	Cover plate , Stainless steel cover plate 3" W x 10" H, with arrows, shield and hardware, uses WB-22 Arrow
11	WB-22	K64201	Arrow , White frosted arrow, 2-1/2", Lexan
12	WB-28	681A508H02	Lamp socket with leads
	WB-31	866A123H01	Lamp socket with insulator for 60MB lamp
13	ML-7	X46AS3H44	Lamp 90V
	ML-6	X46AS2H20	Lamp 120V



WB-6C



WB-6D



WB-6F

S.E.E.S. #	O.E.M. #	Description
WB-6C	1718C78H01	Hall base plate for rotodial Type "A"
WB-6D	2638C89G02	Hall pushbutton station complete, Type AE
WB-6F	198C578G01	Base plate alone for WB-6D Type AE button
WB-6G		Clamp, button assembly
WB-6H		P.B.Station, AEPB Arrow & Fire Service

Car Signal Components

Types A and AE

S.E.E.S. #	O.E.M. #	Description
WB-5-	103D251H	Button , 1.125" Type A, black button with white marking, specify marking i.e. WB-5-1
WB-6-	103D250H	Button , 1.125" Type A, white button with black marking, specify marking i.e. WB-6-1
WB-6A	146A560H05	Clear cap , raised ADA clear cap for E line buttons
WB-6AE-	5204D64H	Button , Type AE white button with black marking, specify marking, i.e. WB-6AE-2
WB-6H	5204D64H	Push Button Station , AEPB Arrow & Fire Service



WB-5-1

Gorton Condensed Characters



WB-6AE-2

Helvetica Medium Characters



WB-6A

Car Signal Components

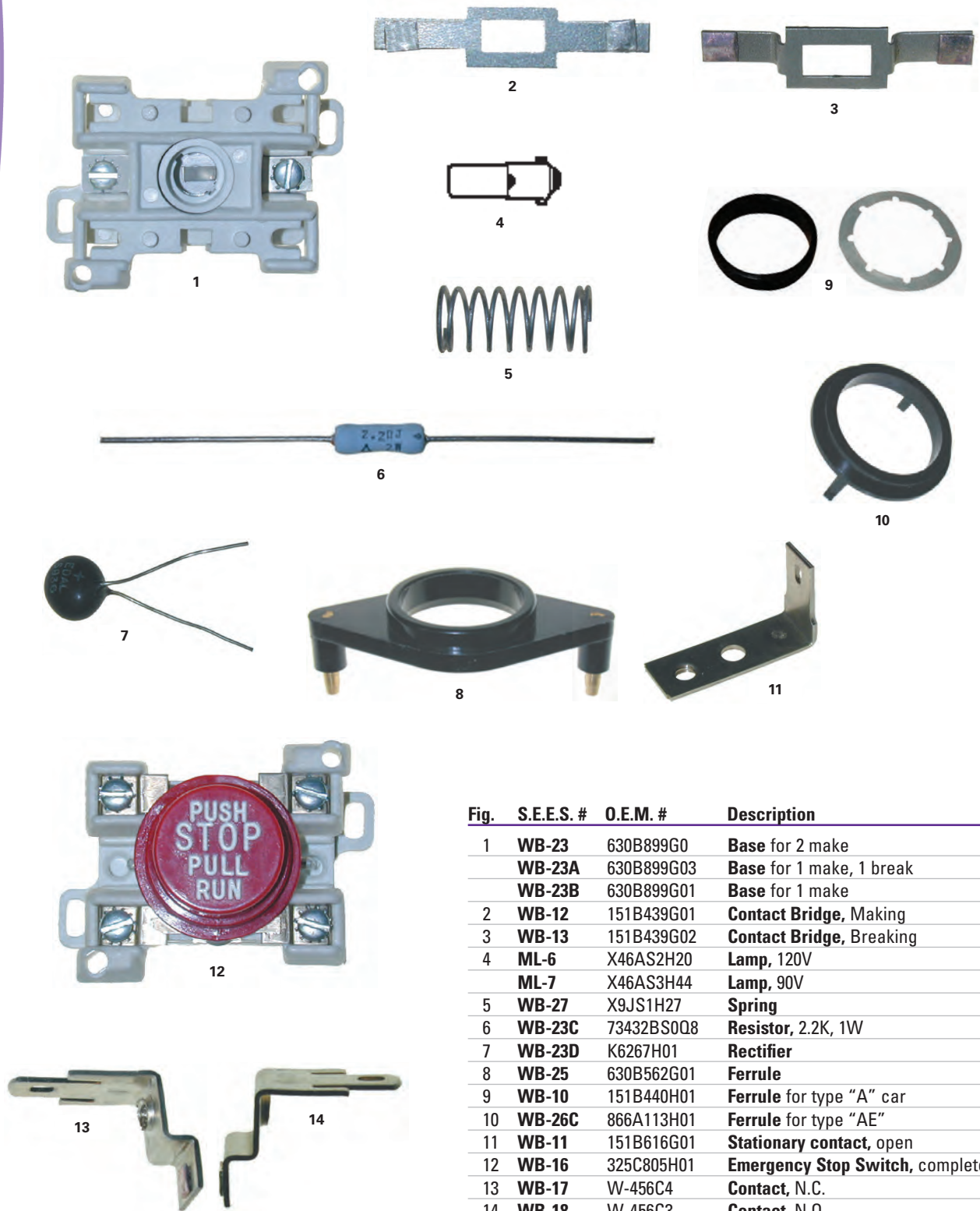

Fig.	S.E.E.S. #	O.E.M. #	Description
1	WB-23	630B899G0	Base for 2 make
	WB-23A	630B899G03	Base for 1 make, 1 break
	WB-23B	630B899G01	Base for 1 make
2	WB-12	151B439G01	Contact Bridge, Making
3	WB-13	151B439G02	Contact Bridge, Breaking
4	ML-6	X46AS2H20	Lamp, 120V
	ML-7	X46AS3H44	Lamp, 90V
5	WB-27	X9JS1H27	Spring
6	WB-23C	73432BS0Q8	Resistor, 2.2K, 1W
7	WB-23D	K6267H01	Rectifier
8	WB-25	630B562G01	Ferrule
9	WB-10	151B440H01	Ferrule for type "A" car
10	WB-26C	866A113H01	Ferrule for type "AE"
11	WB-11	151B616G01	Stationary contact, open
12	WB-16	325C805H01	Emergency Stop Switch, complete
13	WB-17	W-456C4	Contact, N.C.
14	WB-18	W-456C3	Contact, N.O.

Car Signal Components



Type E Pushbutton Assembly

Fig.	S.E.E.S. #	O.E.M. #	Description
1	WB-4E12-		Pushbutton assembly , two normally open contacts, specify marking
	WB-4E13-		Pushbutton assembly , one normally open contact, specify marking
	WB-4E14-		Pushbutton assembly , one normally closed contact, specify marking
	WB-4E15-		Pushbutton assembly , one normally open and one normally closed contact, specify marking
2	WB-4E2	216B298H01	Base , Push button base
	WB-4E2A	196C698H02	Housing , deep recess for pushbutton assembly
3	WB-3-	323C854H	Button , White, with black marking, specify marking i.e. WB-3-1
4	WB-4-	323C854H	Button , Black, with white marking, specify marking i.e. WB-4-2
5	WB-6A	146A560H05	Clear Cap , raised ADA clear cap for E line buttons
	WB-6AB	W-454-BC1	Clear Cap , raised ADA clear cap for A line buttons
6	WB-4E3	145A390G02	Stationary contact , normally open
7	WB-4E4	145A390G01	Stationary contact , normally closed
8	WB-4E5	145A395G01	Movable contact bridge , normally open
9	WB-4E6	145A395G02	Movable contact , normally closed
10	WB-4E7	145A391G01	Mounting bracket
11	WB-4E8		Insulator
12	WB-4E9	X9J20	Spring , normally open, for E line buttons
13	WB-4E10		Spring , normally closed, heavy duty
14	WB-4E11		Screw , zinc plated steel
15	WB-4E1	576B294G01	Emergency Stop Switch assembly
16	ML-42	X46AS1H05, H26	Lamp , clear 230V (used with APB-14 lamp holder)
	ML-34	X46AS1H06, H27	Lamp , red 230V (used with APB-14 lamp holder)
	ML-35	X46AS1H07, H28	Lamp , green 230V (used with APB-14 lamp holder)
	WB-39		Bezel , Red, blank, Fits Type E Pushbutton Fixture (Anodized Aluminum)
17	WB-39-		Bezel , Red, White marking, Fits Type E Pushbutton Fixture (Anodized Aluminum), specify marking i.e. WB-39-Hold-On-Fire
	WB-39A		Base , Black Fits Type E Pushbutton Fixture (Plastic)



Car Signal Components



WKS-1



WKS-4

Type E Key Switch Assembly

S.E.E.S. #	Description
WKS-1	Key Switch , Fire service, Phase I, 3 Position, Key removable in 2 positions ON & OFF only, Double Pole, Fits Type "E" Push button Fixture, Key # H341 or WK-1 key, Red, white marking, OFF/ON/FIRE/BYPASS, (Anodized Aluminum)
WKS-2	Key Switch , Fire service, Phase II, 3 Position, Key removable in all positions, Double Pole, Fits Type "E" Push button Fixture, Key # H341 or WK-1 key, Red, white marking, HOLD/ON/FIRE/OFF (Anodized Aluminum)
WKS-4	Key Switch , Run-Stop, 2 Pos 2KP, with UTC Key



8



1



2

3



2



3



4



5



6



7



9

Position Indicators Types A and AE

Fig.	S.E.E.S. #	O.E.M. #	Description
1	WB-24-	325C877G01	P.I. Lens , Type A position indicator lens, white with black marking, i.e. WB-24-3
2	WB-26B-	5213D27G01	P.I. Lens , Type AE position indicator lens, white with black marking, i.e. WB-26B-6
3	WB-6A	146A560H05	Clear cap , raised ADA clear cap for E line buttons
4	WB-26	569A920H01	Ferrule , Type A
5	WB-26A	X4SS1H02	Nut , Speed nut
6	WB-26B	196C557H01	Ferrule , Type AE, includes speed nut
	WB-26C	366A113H01	Ferrule , Type AE insert
7	WB-14	569A868H01	Reflector funnel for lamp
8	WB-38	X46CS1H08	Lamp Fluorescent lamp
9	WB-32	681A790H01	Lamp holder for A and AE signal

Car Signal Components

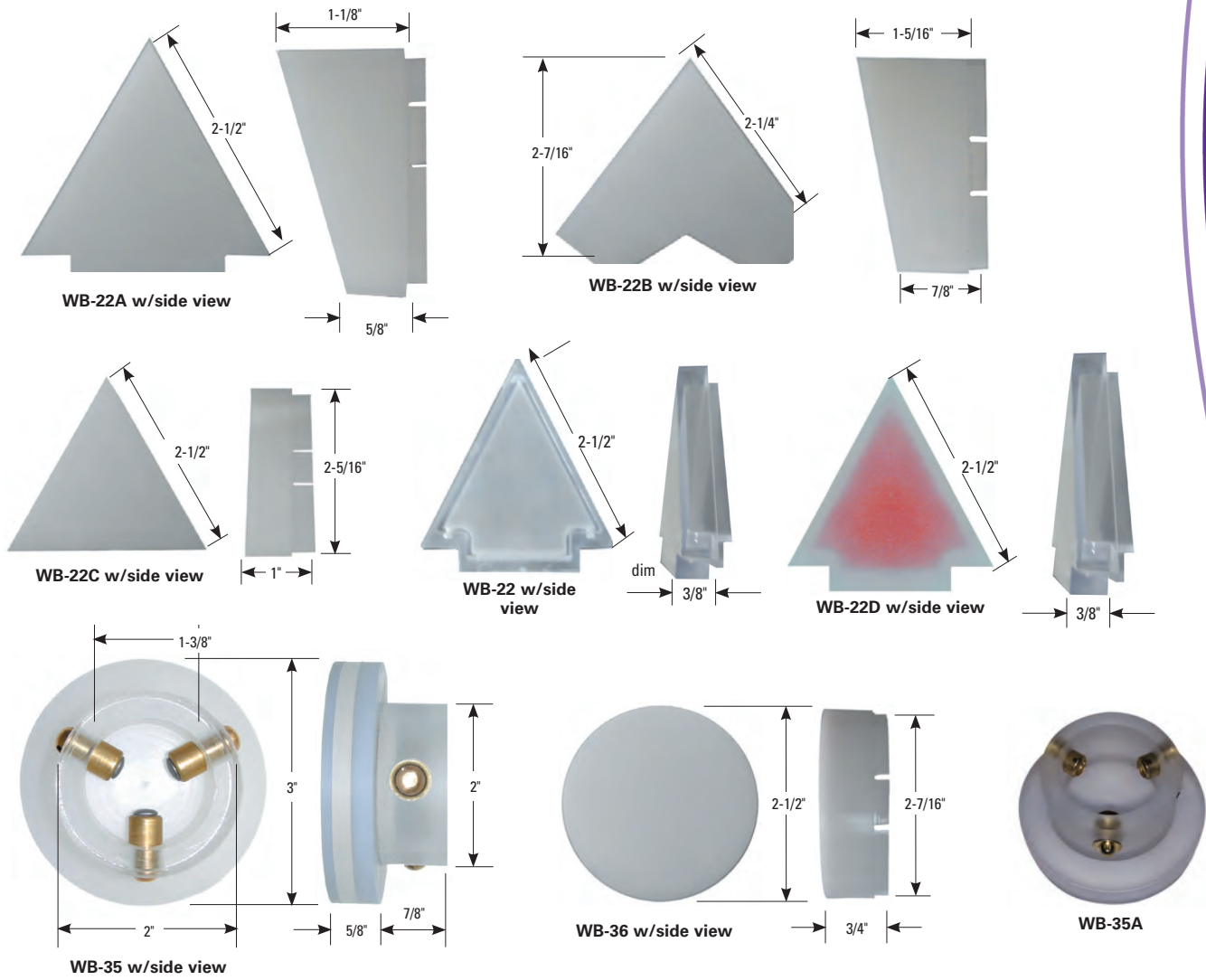

S.E.E.S. #	O.E.M. #	Description
WB-22A	103D605H01	Lens, Lantern lens, arrow, white frosted Lexan
WB-22B	103D605H02	Lens, Lantern lens, Chevron style, white frosted Lexan
WB-22C	1718C18H01	Lens, Lantern lens, arrow, white frosted Lexan
WB-22	K64201	Lens, White frosted arrow, 2-1/2", Lexan
WB-22D	630B023G01	Lens, White frosted arrow on red, 2-1/2", Lexan
WB-35	195C989G03	Lens, Round lens with bullet catches, 3" dia. x 1-1/4"
WB-35A		Round Lens, 3" O.D. x 5/8" W x 1" Neck, Clear Sandblasted
WB-35B		Square Lens, 4" x 4" w/ 2-5/8" Sq Back and Bullet Catch
WB-35C		Round Lens, 3" O.D. x 5/8" W x 1.875" Neck, Clear
WB-35D		Round Lens, 3-3/4" O.D. x 1/8" W x 1" Neck, Clear
WB-35E		Round Lens, 4" O.D. x 5/8" W with 3" O.D. x 7/8" L Neck,
	White/Clear	
WB-35-SPECIAL		Round Lens, 3" diameter with bullet catch, special
WB-35F		Round Lens, 4" O.D. x 1/2" W with 2" O.D. x 2" L Neck, Clear Frosted, with Bullet Catches
WB-35G		Lens, 3" O.D. x 3/4, 1-3/4" O.D. x 7/8" Neck
WB-35H		Lens, 3" O.D. x 5/8, 1-3/4" O.D. x 7/8" Neck, Clear, No Diffuser
WB-36	103D605H03	Lens, Round lantern lens, 2-1/2" diameter x 3/4"



WB-35F



WB-35B



Car Signal Components

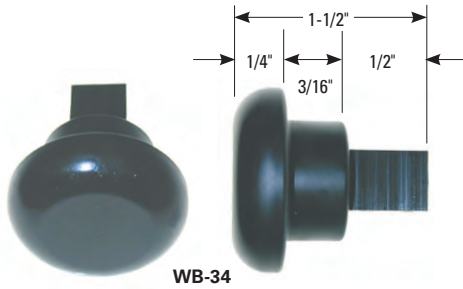

WB-34

S.E.E.S. #	O.E.M. #	Description
WB-34	K4912H01	Button , Black, Hall mushroom style pushbutton 1-1/8" diameter with stem
WB-29	569A925G01	Lock and cam assembly , uses key WB-29A
WB-29A		Key , only, #F359
WB-30	145A681H01	Mercury switch
WB-37	151B514H02	M.G. switch for car station, no spring return
WB-37A	151B74H01	Switch , Momentary Rocker Switch, (1-1/8" x 1-3/8" hole)
WB-37B	7257C63H06	Switch , Rocker DPDT for Car Top Inspection, maintaining
WB-33	576B583G01	Gong and coil assembly , 50-60 watt series, 2-1/2" diameter



WB-29



WB-37



WB-37A



WB-30



WB-33



WB-37B

*Don't see what you're looking for?
Please inquire. We are constantly adding
new items to our inventory.
Today's special orders are tomorrow's stock parts!*

Belts

Timing Belts, 3/8 Pitch

S.E.E.S. #	O.E.M. #	Width	Teeth	Circ.
WBLT-1	144A600H04	1/2"	64	24"
WBLT-2	144A600H01	1/2"	68	25-1/2"
WBLT-3	144A600H15	1/2"	72	27"
WBLT-4	144A600H14	1/2"	76	28-1/2"
WBLT-5	144A600H18	1/2"	86	32-1/4"
WBLT-6	144A600H02	1/2"	120	45"
WBLT-7*	144A600H10	1/2"	120	45"
WBLT-8	144A600H13	1/2"	144	54"
WBLT-9	144A600H12	1/2"	160	60"
WBLT-10	144A600H16	1/2"	176	66"
WBLT-11	144A600H05	1/2"	194	72-3/4"
WBLT-12	144A600H27	1"	120	45"
WBLT-14	144A600H07	1"	144	54"
WBLT-15	144A600H09	1"	160	60"
WBLT-16	144A600H08	1"	176	66"
WBLT-17	144A600H11	2"	120	45"

*Steel reinforced.

S.E.E.S. #	O.E.M. #	Description
WBLT-18	144A417H02	Timing belt for "E" door operator, 81-3/4" x 1/2"
WBLT-18A	144A417H01	Timing belt , steel cord, for "E" door operator, 81-3/4" x 1/2"
WBLT-28	144A600H28	Timing belt , 136 teeth, 1" W, 51" circ., 3/8" pitch
WBLT-19	144A416G01	V-belt for "E" door operator, 99" L
WBLT-27	144A416H03	V-belt for E Operator, 5/8" x 100" L
WBLT-20	691B789H05	Drive belt , steel cord, for "BB" and "BT" escalators, 1" W, 140" circumference, 1/2" pitch
WBLT-20A	691B789H07	Drive belt , steel cord, for "BB" and "BT" escalators, 1" W, 170" circumference, 1/2" pitch
WBLT-20F		Drive belt , "Flexten" reinforced (stronger than steel), for "BB" and "BT" escalators, 1" W, 140" circumference, 1/2" pitch
WBLT-20FG		Drive Belt , "BB&BT" ESC.1/2PX1WX 140 C - Fiberglass Cord
WBLT-20G	693B415H01	Belt , door operator 7 rib for QKS-16 operator
MDO-1	5207D42H46	V-Belt , 4L550 (EZ/QKS-14/15 door operator)

S.E.E.S. #	O.E.M. #	Description
WBLT-21	X40AS1H10	V-Belt , 43" L, for "S" and "MS" operators
WBLT-22	X40AS1H11	V-Belt , 61" L, for "MIS" operators
WBLT-23	569A957H06	Drive belt , 3-1/4" W x 81.5" circ., 20 grooves run the length of the belt
WBLT-24	569A957H04	Pump belt , 71.5" circ., 20 grooves
WBLT-26	569A957H07	Pump belt , 69.5" circ., 10 grooves

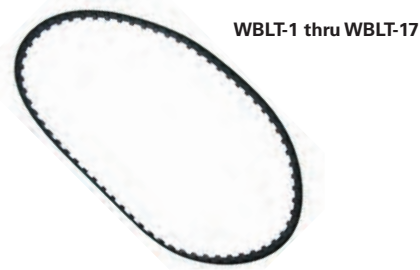

WBLT-1 thru WBLT-17



WBLT-18, WBLT-18A



WBLT-20, WBLT-20A, WBLT-20F



WBLT-20F-A



WBLT-20-FG



WBLT-21, WBLT-22

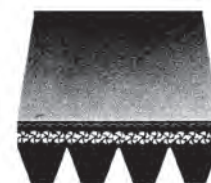

WBLT-23 Cross Section



WBLT-23



Brushes



S.E.E.S. #	O.E.M. #	Grade	Shunt Length	Thick. x W x L
WCB-1A	X38A78	E36	3	.472 x .787 x 1-1/4
WCB-139	X38A93	N5000	4-1/8	3/8 x 1-1/4 x 2
WCB-140	E56019	H44	5	3/8 x 1-1/4 x 2
WCB-1	X38A62	W128	3	3/8 x 3/4 x 1-1/4
WCB-2	X38A65	W805	3	3/8 x 3/4 x 1-1/2
WCB-3	X38A74	W2065	3	3/8 x 3/4 x 1-1/2
WCB-4	X38A64	W805	3	3/8 x 1 x 1-1/2
WCB-5	X38A73	W784	3	3/8 x 1 x 1-1/2
WCB-6	X38A63	W128	3	3/8 x 1 x 1-1/2
WCB-7	X38A12	WP11	3-1/2	3/8 x 1 x 1-1/2
WCB-8	X38A13	WA25	4-1/4	3/8 x 1 x 1-1/2
WCB-9	X38A3	WM56A	3	3/8 x 1 x 1-3/4
WCB-10	X38A6	WM60	3	1/2 x 1 x 1-3/4
WCB-11	X38A16	WM56A	3	1/2 x 1 x 1-3/4
WCB-12	X38A39	WP11	3	1/2 x 1 x 1-3/4
WCB-13	X38A72	W805	3	1/2 x 1 x 1-3/4
WCB-14	X38A36	WP11	3	5/8 x 1 x 1-3/4
WCB-15	X38A68	W805	3	5/8 x 1 x 1-3/4
WCB-16	X38A4	WM60	3	3/8 x 1-1/4 x 1-3/4
WCB-17	X38A69	W805	3	3/8 x 1-1/4 x 1-3/4
WCB-18	X38A67	W805	3	1/2 x 1-1/4 x 1-3/4
WCB-19	X38A75	W784	3	1/2 x 1-1/4 x 1-3/4
WCB-20	X38A32	WP11	3	1/2 x 1-1/4 x 1-3/4
WCB-21	X38A7	WM60	3	1/2 x 1-1/4 x 1-3/4
WCB-22	X38A9	WM56A	3-1/2	1/2 x 1-1/4 x 1-3/4
WCB-23	X38A17	WM56A	3	5/8 x 1-1/4 x 1-3/4
WCB-24	X38A40	WP11	3	5/8 x 1-1/4 x 1-3/4
WCB-147	X38A30	N5000	3	5/16" x 1-1/4" x 2"
WCB-147A	X38AB8	H44	4-1/4	3/8" x 1-1/4" x 2"

S.E.E.S. #	O.E.M. #	Grade	Length	Thick. x W x L
WCB-26	X38B7	W805	3	3/8 x 3/4 x 1-1/4
WCB-27	X38B8	WL276	3	3/8 x 3/4 x 1-1/4
WCB-28	X38B9	W2064	3	3/8 x 3/4 x 1-1/4

WCB-28A	X38BS1H12		3	3/8 x 3/4 x 1-1/4
WCB-123A	X38RS3H36		2-3/4	3/8 x 1 x 1-1/4

S.E.E.S. #	O.E.M. #	Grade	Shunt Length	Thick. x W x L
WCB-30	X38C18	W805	3	3/8 x 1 x 1-3/4
WCB-31	X38C21	W784	3	3/8 x 1 x 1-3/4
WCB-32	X38C14	W805	3	1/2 x 1 x 1-3/4
WCB-33	X38C22	W784	3	1/2 x 1 x 1-3/4
WCB-34	X38C6	Graphite	3	1/2 x 1-1/4 x 1-3/4
WCB-34A	X38C6	Carbon	3	1/2 x 1-1/4 x 1-3/4
WCB-35	X38C8	W128	3	1/2 x 1-1/4 x 1-3/4
WCB-36	X38C15	W805	3	1/2 x 1-1/4 x 1-3/4
WCB-37	X38C23	W784	3	1/2 x 1-1/4 x 1-3/4
WCB-38	X38C20	W510	3	1/2 x 1-1/4 x 1-3/4
WCB-39	X38C19	WL276	3	1/2 x 1-1/4 x 1-3/4
WCB-40	X38C16	W805	3	3/8 x 1-1/2 x 1-3/4
WCB-41	X38C24	W784	3	3/8 x 1-1/2 x 1-3/4
WCB-45A	X38C4	N5000	3-1/8	3/8 x 1-1/2 x 1-3/4
WCB-43	X38C25	W784	3	1/2 x 1-1/2 x 1-3/4
WCB-44	X38C17	W805	3	1/2 x 1-1/2 x 1-3/4
WCB-45B	X38C2	N5000	3-1/4	1/2 x 1-1/4 x 1-3/4
WCB-45C	X38C30	N5000	3-1/8	1-3/8 x 1-1/2 x 1-3/4
WCB-45	X38C3	N5000	4-3/4	1/2 x 1-1/2 x 2
WCB-146	X38C32	EG18	3	3/8 x 1" x 1-3/4"
WCB-148	21820	FHP N1		.249" x .374" x .859"
WCB-149		H49		1/2" x 1" x 1-1/2"
WCB-150		H45		.492" x 1.26" x 2"

S.E.E.S. #	O.E.M. #	Grade	Shunt Length	Thick. x W x L
WCB-46	X38E4	WA20B	2	1/4 x 1/2 x 1
WCB-47	X38E13	HRG	3	1/4 x 1/2 x 1
WCB-48	X38E15	W417	2	1/4 x 1/2 x 1
WCB-52	X38E14	WP3	2-1/2	1/2 x 3/4 x 1-1/4
WCB-53	X38E16	N44	2-1/2	1/2 x 3/4 x 1-1/4
WCB-54	X38E17	N44	2-1/2	1/2 x 3/4 x 1-1/4
WCB-49	X38E12	HRG	3	1/4 x 3/4 x 1-1/4
WCB-50	X38E1	N44	3	1/4 x 3/4 x 1-1/4
WCB-51	X38E18	WP3	2-1/2	1/4 x 3/4 x 1-1/4
WCB-141	X38E54	H44	2	1/4 x 3/4 x 1-1/4



■ DIMENSIONS IN INCHES

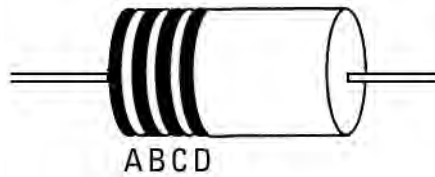

COLOR CODE FOR RESISTOR

COLOR	A	B	C	D
	1st Significant Figure	2nd Significant Figure	Multiplier	% Tolerance
Black	0	0	x1	1
Brown	1	1	x10	2
Red	2	2	x100	3
Orange	3	3	x1,000	4
Yellow	4	4	x10,000	
Green	5	5	x100,000	
Blue	6	6	x1,000,000	
Violet	7	7	x10,000,000	
Gray	8	8	x100,000,000	
White	9	9	x1,000,000,000	
Silver			x0.1	10
Gold			x0.01	5
Missing Band				20

EXAMPLES:

Orange-Green-Red-Silver	$35 \times 10^2 \pm 10\% = 3500 \text{ Ohms}$ @ $\pm 10\%$ tolerance	3150 to 385 Ω
Brown-Black-Orange-Gold	$10 \times 10^3 \pm 5\% = 10,000 \text{ Ohms}$ @ $\pm 5\%$ tolerance	95000 to 1050 Ω
Purple-Yellow-Black-Gold	$74 \pm 5\% = \text{Ohms}$ @ $\pm 5\%$ tolerance	71.5 TO 77.5 Ω
Purple-Yellow-Black	$74 = 20\% = 74 \text{ Ohms}$ @ 20% tolerance	60 to 88 Ω

If the first color band is double width, the resistor is wire wound. Black body indicates a composite non-insulated resistor. Colored body indicates a composite insulated resistor.

Courtesy of ELEVATOR WORLD, INC., from Elevator Maintenance Manual. Copyright © 1999. Reprinted by permission.

Brushes

■ DIMENSIONS IN INCHES

Fig. # 1

S.E.E.S. #	O.E.M. #	Grade	Shunt Length	Thick. x W x L
WCB-55	X38E19	W687	1-1/4	7/32 x 9/32 x 15/16
WCB-57	X38E9	W687	1-1/2	1/4 x 1/2 x 1-1/8
WCB-56	X38E2	X18	1-1/2	1/4 x 1/2 x 1-1/8
WCB-58	X38E6	WL276	2	1/4 x 3/4 x 1-7/16
WCB-59	X38E20	W805	2	1/4 x 3/4 x 1-1/4
WCB-60	X38E22	W128	2	1/4 x 3/4 x 1-1/4
WCB-61	X38E23	W2043	2	1/4 x 3/4 x 1-1/4
WCB-62	X38E24	W2065	2	1/4 x 3/4 x 1-1/4
WCB-63	X38E25	W2064	2	1/4 x 3/4 x 1-1/4
WCB-59A*	X38E21	WP11	2	1/4 x 3/4 x 1-1/4
WCB-64	X38E10	W417	2	1/4 x 3/4 x 1-3/8
WCB-145	X38E52	W75B	2	1/4 x 3/4 x 1-1/4

*No spring

Fig. # 2

S.E.E.S. #	O.E.M. #	Grade	Thick. x W x L
WCB-65	X38F3	W13L	1/2 x 1/4 x 3/16
WCB-66	X38F1	WL317	5/8 x 9/32 x 7/32
WCB-66A	X38F8	N5000	.212 x .275 x .5
WCB-67	X38F4	W805	3/4 x 1/4 x 3/16

Fig. # 3

S.E.E.S. #	O.E.M. #	Grade	Shunt Length	Thick. x W x L
WCB-29	X38G3	WP85	2-1/2	1/2 x 3/4 x 1-1/4

Fig. # 4

WCB-68	X38H5	W13L	1-1/8	3/16 x 1/4 x 9/16
WCB-69	X38H7	W417	1-1/2	1/4 x 1/4 x 3/4
WCB-70	X38H1	WL21	2-1/2	3/16 x 1 x 1

Fig. # 5

WCB-25	X38J3	WL21	1-5/8	3/16 x 1/2 x 7/8
--------	-------	------	-------	------------------

Fig. # 6

WCB-70C	X38K4	W784	4-1/4	3/8 x 1 x 1-1/2
---------	-------	------	-------	-----------------

Fig. # 7

WCB-70A	X38K5	W784	3	3/8 x 1 x 1-3/4
WCB-70B	X38K6	W784	3	1/2 x 1 x 1-3/4
WCB-70D	X38K8	W805	3	3/8 x 1 x 1-3/4
WCB-70F	X38K7	W784	3	1/2 x 1-1/4 x 1-3/4
	X38-K15			
WCB-70G	WEL-99	H22	3	3/8 x 1 x 1-3/4



Fig. # 1: WCB-55 thru WCB-64



Fig. # 2: WCB-65 thru WCB-67



Fig. # 3: WCB-29

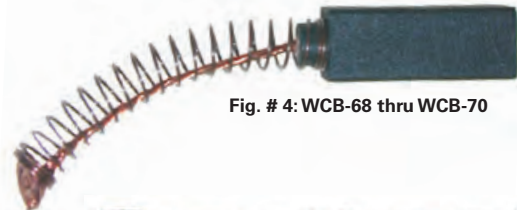

Fig. # 4: WCB-68 thru WCB-70



Fig. # 5: WCB-25



Fig. # 6: WCB-70C



WCB-70F



WCB-70G



Fig. # 7: WCB-70A thru WCB-70D



Brushes

Fig. # 1:
WCB-71 thru WCB-77



Fig. # 2:
WCB-78 thru WCB-89



Fig. # 3: WCB-90, WCB-91

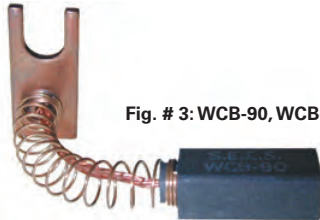

■ DIMENSIONS IN INCHES

FIG. # 1

S.E.E.S. #	O.E.M. #	Grade	Shunt Length	Thick. x W x L
WCB-71	X38L8	W805	3	1/2 x 1 x 1-1/4
WCB-72	X38L1	WP11	3	1/2 x 1 x 1-1/2
WCB-73	X38L2	WP11	3	1/2 x 1-1/2 x 1-1/2
WCB-74	X38L10	W805	3	1/2 x 1-1/2 x 1-1/2
WCB-75	X38L9	W805	3	1/2 x 1-1/2 x 1-3/4
WCB-76	X38L12	W784	3	1/2 x 1-1/2 x 1-3/4
WCB-77	X38L3	WP11	3	1/2 x 1-1/2 x 1-3/4

FIG. # 2

S.E.E.S. #	O.E.M. #	Grade	Shunt Length	Thick. x W x L
WCB-78	X38M3	WP11	3	3/8 x 1 x 1-1/4
WCB-79	X38M9	W805	3	3/8 x 1 x 1-1/4
WCB-80	X38M4	W128	3	3/8 x 1 x 1-1/4
WCB-81	X38M15	W784	3	3/8 x 1 x 1-1/4
WCB-82	X38M17	W2065	3	3/8 x 1 x 1-1/4
WCB-83	X38M16	W784	3	5/16 x 1-1/2 x 1-1/2
WCB-85	X38M10	W805	3	5/16 x 1-1/2 x 1-3/4
WCB-86	X38M20	W784	3	5/16 x 1-1/2 x 1-3/4
WCB-84	X38M12	W805	3	5/16 x 1-1/2 x 1-1/2
WCB-87	X38M19	W784	3	3/8 x 1-1/2 x 1-3/4
WCB-88	X38M11	W805	3	3/8 x 1-1/2 x 1-3/4
WCB-89	X38M13	W805	3	1/2 x 1-1/2 x 1-3/4

Fig. # 4:
WCB-115, WCB-116, WCB-117



Fig. # 5:
WCB-92 thru WCB-114



FIG. # 3

S.E.E.S. #	O.E.M. #	Grade	Shunt Length	Thick. x W x L
WCB-90	X38N1	W805	1-1/8	1/4" x 5/16" x 3/4"
WCB-91	X38N2	WA20B	1-1/8	1/4" x 5/16" x 1"

FIG. # 4

S.E.E.S. #	O.E.M. #	Grade	Shunt Length	Thick. x W x L
WCB-116	X38Q18	W2065	2-3/4	1/2" x 1" x 1-1/4"
WCB-115	X38Q28	W784	2-3/4	3/8" x 1" x 1-1/4"
WCB-117	X38Q22	W2045	3-1/2	1/2" x 1" x 1-1/2"

FIG. # 5

S.E.E.S. #	O.E.M. #	Grade	Shunt Length	Thick. x W x L
WCB-92	X38Q1	W510	3-1/2	3/8 x 1 x 1-1/2
WCB-93	X38Q2	W510	3-1/2	1/2 x 1 x 1-1/2
WCB-94	X38Q32	W784	3-1/2	3/8 x 1-1/2 x 1-1/2
WCB-95	X38Q23	W2045	3-1/2	1/2 x 1-1/2 x 1-1/2
WCB-96	X38Q8	W805	3-1/2	1/2 x 1-1/2 x 1-1/2
WCB-97	X38Q3	W510	3-1/2	1/2 x 1-1/2 x 1-1/2
WCB-98	X38Q17	W784	4-1/4	1/2 x 1-1/2 x 1-1/2
WCB-99	X38Q10	W805	4-1/4	1/2 x 1-1/2 x 1-1/2
WCB-100	X38Q15	W784	4-1/4	1/2 x 1-1/2 x 1-1/2
WCB-101	X38Q14	W784	3-1/2	5/8 x 1-1/2 x 1-1/2
WCB-102	X38Q26	W2045	3-1/2	5/8 x 1-1/2 x 1-1/2
WCB-103	X38Q9	W805	3-1/2	5/8 x 1-1/2 x 1-1/2
WCB-104	X38Q4	W510	3-1/2	5/8 x 1-1/2 x 1-1/2
WCB-107	X38Q11	W805	4-1/4	5/8 x 1-1/2 x 1-3/4
WCB-105	X38Q24	W2045	4-1/4	1/2 x 1-1/2 x 1-3/4
WCB-106	X38Q5	W510	4-1/4	1/2 x 1-1/2 x 1-3/4
WCB-108	X38Q25	W2045	4-1/4	5/8 x 1-1/2 x 1-3/4
WCB-109	X38Q20	W784	4-1/4	5/8 x 1-1/2 x 1-3/4
WCB-110	X38Q6	W510	4-1/4	5/8 x 1-1/2 x 1-3/4
WCB-111	X38Q12	W805	4-1/4	3/4 x 1-1/2 x 1-3/4
WCB-112	X38Q16	W784	4-1/4	3/4 x 1-1/2 x 1-3/4
WCB-114	X38Q19	W784	4-1/4	1 x 1-1/2 x 1-3/4

Brushes

■ DIMENSIONS IN INCHES

Fig. # 1

S.E.E.S. #	O.E.M. #	Grade	Shunt Length	Thick. x W x L
WCB-118	X38R24	W510	2-1/2	3/8 x 5/8 x 1
WCB-119	X38R18	W2008	2-3/4	3/8 x 5/8 x 1-1/4
WCB-123	X38R1	W510	2-3/4	3/8 x 1 x 1-1/4
WCB-124	X38R2	W805	2-3/4	3/8 x 1 x 1-1/4
WCB-125	X38R10	W2045	2-3/4	3/8 x 1 x 1-1/4
WCB-126	X38R6	W784	2-3/4	3/8 x 1 x 1-1/4
WCB-122	X38R19	W510	2-3/4	1/2 x 5/8 x 1-1/4
WCB-127	X38R3	W805	2-3/4	1/2 x 1 x 1-1/4
WCB-128	X38R15	W2045	3-1/2	1/2 x 1 x 1-1/2

Fig. # 2

S.E.E.S. #	O.E.M. #	Grade	Shunt Length	Thick. x W x L
WCB-120	X38R14	W2045	2-3/4	3/8 x 5/8 x 1-1/4
WCB-121	X38R22	W510	2-3/4	3/8 x 5/8 x 1-1/4
WCB-129	X38R21	W2045	3-1/2	3/8 x 1 x 1-1/2
WCB-133	X38R17	W2008	3-1/2	1/2 x 1-1/2 x 1-1/2
WCB-134	X38R12	W2045	3-1/2	1/2 x 1-1/2 x 1-1/2
WCB-130	X38R16	W2008	3-1/2	3/8 x 1-1/2 x 1-1/2
WCB-131	X38R11	W2045	3-1/2	3/8 x 1-1/2 x 1-1/2
WCB-132	X38R4	W510	3-1/2	3/8 x 1-1/2 x 1-1/2
WCB-135	X38R5	W510	3-1/2	1/2 x 1-1/2 x 1-1/2
WCB-136	X38R23	W2008	3-1/2	5/8 x 1-1/2 x 1-1/2
WCB-136A	X38R13	W2045	3-1/2	5/8 x 1-1/2 x 1-1/2

Fig. # 3

S.E.E.S. #	O.E.M. #	Grade	Shunt Length	Thick. x W x L
WCB-137	X38T1	W687	1-5/8	3/16 x 1/4 x 1

Fig. # 4

S.E.E.S. #	O.E.M. #	Description	Thick. x W x L
WCB-138	569A803H02	For Tach Generator	3/16 x 9/16

Fig. # 5

S.E.E.S. #	O.E.M. #	Grade	Shunt Length	Thick. x W x L
WCB-2A	229610	255	3-7/8	3/8 x 3/4 x 1-1/2
WCB-2B	222319	255	3-7/8	3/8 x 1 x 1-3/4

S.E.E.S. #	O.E.M. #	Description
WCB-143	BHC249	Brush Caps for WDO-61J, set of 4
WCB-144		Brush Cap for WDO-61G
WCB-147	X38ABS2H30	Carbon brush, 5/16" x 1-1/4" x 2"



Fig. # 1:
WCB-118 thru WCB-119 & WCB-123 thru WCB-128



WCB-121



Fig. # 2:
WCB-120, WCB-121 and WCB-129 thru WCB-136A



WCB-131



Fig. # 3: WCB-137

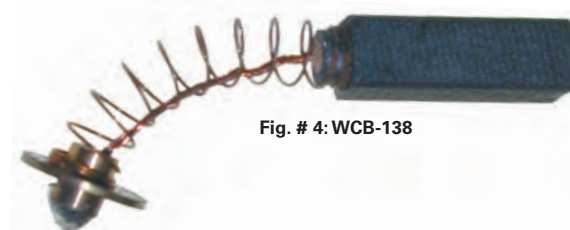

Fig. # 4: WCB-138



Fig. # 5: WCB-2A, WCB-2B



WCB-144



WCB-143



Brush Holders



WBH-05



WBH-011



WBH-012



WBH-D01



WBH-04

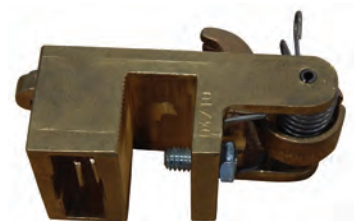

WBH-D05

For SKH Motors Constant Pressure Style

S.E.E.S. #	O.E.M. #	Rod	Brush holder		No. of
			Width	Thick	Brushes
WBH-01	4110D65G01	1/2"	5/8"	3/8"	1
WBH-02	4110D65G02	1/2"	5/8"	1/2"	1
WBH-03	4110D65G03	1/2"	5/8"	3/8"	1
	556D008G01				
WBH-04	4110D65G04	1/2"	5/8"	1/2"	1
	556D008G02				
WBH-05	4110D65G05	1/2"	1"	3/8"	1
	556D008G13				
WBH-06	4110D65G06	1/2"	1"	1/2"	1
WBH-07	4110D65G07	3/4"	1"	3/8"	1
WBH-08	4110D65G08	3/4"	1"	1/2"	1
WBH-09	4110D65G09	3/4"	1"	5/8"	1
WBH-010	4110D65G10	3/4"	1"	1"	1
WBH-011	4110D65G11	3/4"	1-1/2"	3/8"	1
WBH-012	4110D65G12	3/4"	1-1/2"	1/2"	1
WBH-016	4110D65G16	1"	1-1/2"	5/8"	1
WBH-019	4110D65G19	1"	1-1/2"	1-1/4"	1

For SKH Motors Fingerstyle

S.E.E.S. #	O.E.M. #	Rod	Brush holder		No. of
			Width	Thick	Brushes
WBH-D01	556D008G19	1/2"	1"	1/4"	2
WBH-D02	556D008G05	3/4"	1"	1/4"	2
WBH-D03	556D008G06	3/4"	1"	5/16"	2
WBH-D04	556D008G07	3/4"	1"	3/8"	2
WBH-D05	556D008G09	3/4"	1-1/2"	1/2"	2
WBH-D06	556D008G11	3/4"	1-1/2"	5/16"	2
WBH-D07	556D008G12	3/4"	1-1/2"	3/8"	2
WBH-D09	556D008G16	1"	1-1/2"	5/16"	2
WBH-D10	556D008G17	1"	1-1/2"	3/8"	2
WBH-D11	556D008G18	1"	1-1/2"	1/2"	2
WBH-D12	556D008G20	1"	1-1/2"	5/8"	2
WBH-D13	4110D65G13	3/4"	1-1/2"	5/8"	1
WBH-D14	4110D65G14	3/4"	1-1/2"	3/4"	1
WBH-020	556D008G03	3/4"	1"	3/8"	1
WBH-021	556D008G04	3/4"	1"	1/2"	1
WBH-022	556D008G10	3/4"	1-1/2"	1/2"	1
WBH-023	556D203G01	1/2"	5/8"	3/8"	1
WBH-024	556D203G02	1/2"	5/8"	1/2"	1

Replacement Spring Clips

Brush Holders

S.E.E.S. #	Description
WBH-1A	Spring clip 1" W x 2-1/2" O.L., for WBH-011*
WBH-2A	Spring clip 5/8" W x 2" O.L., for WBH-05*
WBH-5A	Spring assembly for holder 4110D65H03
WBH-03A	Spring clip 1/2" W x 2" O.L., for WBH-03*
WBH-07A	Spring clip 5/8" W x 2-3/8" O.L., for WBH-07*

*Clips can be used on other holders as well. Additional clips available, inquire with your requirements.

S.E.E.S. #	O.E.M. #	Description
WBH-3	694B476G01	Exciter Brush holder brush box 3/4" x 1/4"
WBH-3A		Male cap for exciter brush
WBH-4	321C333G01 630B317H01	Double Brush holder brush box 3/8" x 2" wide



WBH-1A



WBH-03A



WBH-3



WBH-07A



WBH-4



WCC-1



WCC-4



WCC-4A



WCC-5



WCC-6

Carbon and Graphite Contacts

S.E.E.S. #	O.E.M. #	Description
WCC-1	T441H20	1-1/4" x 1-1/2" x 1" Square carbon contact
WCC-2	T441H16	1-1/4" x 1-1/2" x 1" Square metal graphite
WCC-3		1-1/2" x 1-1/2" x 2" Square carbon contact
WCC-4	K4495H01	5/8" x 5/8" x 3/4" Square carbon contact with 9/64" hole for 6-32 screw
WCC-4A	61000274	5/8" x 5/8" x 3/4" Square metal graphite with 9/64" hole
WCC-5	K179H01	5/8" x 5/8" x 3/4" Square metal graphite with 3/16" hole for 10-32 screw
WCC-6	P1534H10	1" x 1" x 3/4" Square carbon contact
WCC-7	P1534H02	1" x 1" x 3/4" Square metal graphite contact
WCC-8	K1177G01	1/2" x 1/2" Metal graphite contact



WCC-8



Coils



Fig. #1: WC-86



Fig. #2:
WC-56 thru
WC-59

Fig. #3:
WC-60 thru
WC-62



Fig. #4: WC-63, WC-64



Fig. #5: WC-87



Fig. #7:
WC-18 thru WC-27A



Fig. #8:
WC-1 thru WC-17I



Fig. #6: WC-87A,
WC-88, WC-89

1-9/16" I.D. x 2-3/4" O.D. x 4-1/16" L

S.E.E.S. #	O.E.M. #	Resistance	Fig. #
WC-86	696668	330	1

8/32 Thread I.D. x 1-7/16" O.D. x 2-1/2" L

S.E.E.S. #	O.E.M. #	Volts	Resistance	Fig. #
WC-56	K5801G01	125	2900	2
WC-57	K5801G02	62.5	504	2
WC-58	K5801G03	62.5	714	2
WC-59	K5801G04	125	2180	2

8/32 Thread I.D. x 1-7/16" O.D. x 2-1/2" L

S.E.E.S. #	O.E.M. #	Volts	Resistance	Fig. #
WC-60	K5802G01	125	A-2010, B-1330	3
WC-61	K5802G02	125	A-1815, B-765	3
WC-62	K5802G03	48	A-8210, B-1650	3

■ A = Inner winding resistance B = Outer winding resistance

S.E.E.S. #	O.E.M. #	Volts	Resistance	Fig. #
WC-63	K6738G01	125	1800	4
WC-64	K6738G02	48	450	4

1-17/64" I.D. x 2-49/64" O.D. x 3-43/64" L

S.E.E.S. #	O.E.M. #	Volts/Amps	Resistance	Fig. #
WC-87*	R9822G03	50A	.2	5
WC-87A	R9822G04	125V	582	6
WC-88	R9822G05	230V	1910	6
WC-89	R9822G06	125V	354	6

* 1" I.D. x 2-7/8" O.D.

8/32 Thread I.D. x 1-7/16" O.D. x 2-1/2" L

S.E.E.S. #	O.E.M. #	Volts	Resistance	Fig. #
WC-18	X19BG01	48	205	7
WC-19	X19BG02	190	2820	7
WC-20	X19BG03	94	810	7
WC-21	X19BG04	62.5	637	7
WC-22	X19BG05	24	53	7
WC-23	X19BG06	200	3300	7
WC-24	X19BG07	120	1200	7
WC-25	X19BG08	125	3840	7
WC-27	X19BG11		2400	7
WC-26	X19BG09		1860	7
WC-27A	X19BG14		994	7

17/32" I.D. x 1-5/8" O.D. x 2-3/4" L

S.E.E.S. #	O.E.M. #	Volts	Resistance	Fig. #
WC-1	X19BBG01	230	3300	8
WC-2	X19BBG02	125	987	8
WC-3*	X19BBG03		1625	8
WC-4	X19BBG04		2900	8
WC-5	X19BBG05		2180	8
WC-6	X19BBG06	125	1755	8
WC-7	X19BBG07	62.5	430	8
WC-9	X19BBG09		714	8
WC-10	X19BBG10	125	1720	8
WC-11	X19BBG11	125	1240	8
WC-13	X19BBG13	62.5	324	8
WC-14	X19BBG14	125	1235	8
WC-15	X19BBG15	125	1090	8
WC-16	X19BBG16	125	1800	8
WC-17	X19BBG17	62.5	275	8
WC-17A	X19BBG18	230	4510	8
WC-17B	X19BBG19	48	178	8
WC-17C	X19BBG20	48	197	8
WC-17D	X19BBG21	230	4160	8
WC-17E	X19BBG22	125	1090	8
WC-17F	X19BBG23		1790	8
WC-17G	X19BBG24		1800	8
WC-17H	X19BBG25		4510	8
WC-17I	X19BBG26		0.09	8

* 21/64" I.D. x 1-1/16" O.D. x 15/16" L

Coils

S.E.E.S. #	O.E.M. #	Volts	Resis.	I.D. x O.D. x L
WC-28*	X19CAG01, X19BGG01, X19BGG09, X19BGG17, X19BGG20	125	2870	7/16" x 1-5/32" x 2-3/8"
WC-29*	X19CAG02, X19BGG02, X19BGG10, X19BGG18, X19BGG21	62.5	810	7/16" x 1-5/32" x 2-3/8"
WC-30	X19CAG03, X19BGG03, X19BGG11	25	5700	7/16" x 1-5/32" x 2-3/8"
WC-31	X19CAG04, X19BGG04, X19BGG12	125	1725	25/32" x 1-5/32" x 2-3/8"
WC-32	X19CAG05, X19BGG05, X19BGG13	64	794	7/16" x 1-5/32" x 2-3/8"
WC-33*	X19CAG06, X19BGG06, X19BGG14	62.5	425	7/16" x 1-5/32" x 2-3/8"
WC-34	X19CAG07, X19BGG07, X19BGG15	125	8334	7/16" x 1-5/32" x 2-3/8"
WC-35	X19CAG08, X19BGG08, X19BGG16	21	155	7/16" x 1-5/32" x 2-3/8"

* Used on ES Relays



S.E.E.S. #	O.E.M. #	Resistance/Description	I.D. x O.D. x L
WC-90	X19BCG01	557	29/32" x 2-3/4" x 4-3/8"
WC-92	X19FS1G03	Inductor coil, 125V, 311 ohm	29/32" x 2-3/4" x 4-3/8"
WC-93	M1663G10	Brake coil 115V, 85 ohm	3" x 5.5" x 8.5"
WC-94	X19PS1G05	Esc Brake Coil 120V, 4,000 ohm	
WC-95	19XPS1G01	Brake Coil, Westinghouse	
WC-100	X19ZG11	1630 / Rotodial coil 125V	3/4" x 1-1/16" x 1"



S.E.E.S. #	O.E.M. #	Volts	Resistance	I.D. x O.D. x L
WC-40	X19BHS1G01, X19BHG10, X19CBG01, X19BH-GR1	125	A-2295, B-917	29/64" x 1-3/16" x 2-3/8"

■ A = Inner winding resistance B = Outer winding resistance.

S.E.E.S. #	O.E.M. #	Volts	Resis.	I.D. x O.D. x L
WC-41	X19BJG01, X19CCG01	125	2030	21/32" x 1-7/16" x 2-15/32"
WC-42	X19BJG02, X19CCG02	62.5	545	21/32" x 1-7/16" x 2-15/32"
WC-43	X19BJG03, X19CCG03	230	7322	21/32" x 1-7/16" x 2-15/32"

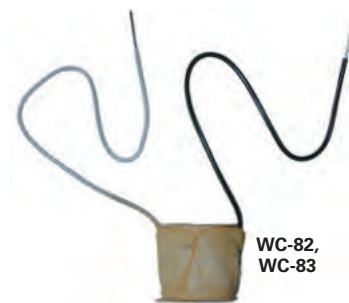

S.E.E.S. #	O.E.M. #	Volts	Resis.	Size	I.D. x O.D. x L
WC-43B	X19BKG01	125	18	1	1-25/32" x 4" x 3-1/4"
WC-43A	X19BKG02	125	1100	2	25/32" x 2-1/4" x 2-9/16"

S.E.E.S. #	O.E.M. #	Volts	Resistance	I.D. x O.D. x L
WC-82	X19BVG01	230	32.4	21/64" x 1" x 31/32"
WC-83	X19BVG02	115	0.73	21/64" x 1" x 31/32"



S.E.E.S. #	O.E.M. #	Volts	Resistance	I.D. x O.D. x L
WC-67	X19EG19	125	918	5/8" x 1-5/8" x 2-3/4"
WC-68	X19EG22	125	13310	5/8" x 1-3/4" x 3-3/16"
WC-70	X19EG25	125	727	1" x 1-3/4" x 3-3/16"



Coils

Starter Coils

13/32" I.D. x 1-5/16" O.D. x 2-5/32" L

S.E.E.S. #	O.E.M. #	Description	Volts
WC-79	505C806G02	Size 2, 60 cycle	208-220
WC-79A	505C633G02	Size 3 & 4, 60 cycle	208-220
WC-79C	506C143G02	Size 2, DC	125
	1268C86G02		

5-3/8" O.D. x 7-1/2" L

S.E.E.S. #	O.E.M. #	Description	Volts
WC-84	X19PS1G01	Brake coil, 117 Ohm, 125 VDC	

4-3/8" O.D. x 5-1/4" L

S.E.E.S. #	O.E.M. #	Description	Volts
WC-85	X19PS1G08	Brake coil, 113 Ohm, 120 VDC	

2-15/16" I.D. x 5-1/2" O.D. x 8-3/8" L

S.E.E.S. #	O.E.M. #	Description	Volts
WC-85A	M1663G10	Brake coil, 85 Ohm, 120 VDC West #57 machine	



WC-79, WC-79A,
WC-79C, WC-79D



WC-84

13/32" I.D. x 1-5/16" O.D. x 2-5/32" L

S.E.E.S. #	O.E.M. #	Volts	Resistance
WC-49	X19GG01	240	4250
WC-50	X19GG02	120	1060
WC-51	X19GG03	300	6250
WC-52	X19GG04	48	166
WC-53	X19GG05	68	410
WC-54	X19GG06	120	272
WC-55	X19GG07	157	1920



WC-49 thru
WC-55



WC-44 thru WC-48



WC-80, WC-81



WC-71 thru
WC-78



WC-66

15/16" I.D. x 2-5/8" O.D. x 2-3/8" L

S.E.E.S. #	O.E.M. #	Volts	Resistance
WC-65	X19KG12	50	125

15/16" I.D. x 2-11/16" O.D. x 3-1/16" L

S.E.E.S. #	O.E.M. #	Volts	Resistance
WC-65B	X19KG15	95	318

15/16" I.D. x 2-5/8" O.D. x 2-7/16" L

S.E.E.S. #	O.E.M. #	Volts	Resistance
WC-65C	X19KG16	105	318



WC-65,
WC-65B, WC-65C

13/32" I.D. x 1-5/16" O.D. x 2-5/32" L

S.E.E.S. #	O.E.M. #	Volts	Resistance
WC-44	X19HG01	240	A-3900, B-467
WC-45	X19HG02	120	A-990, B-467
WC-46	X19HG03	300	A-5800, B-690
WC-47	X19HG04	48	A-13, B-3
WC-48	X19HG05	16	A-20, B-3

13/32" I.D. x 1-5/16" O.D. x 2-5/32" L

S.E.E.S. #	O.E.M. #	Volts	Resistance
WC-80	X19NG10	125	405
WC-81	X19NG11	230	1000

13/32" I.D. x 1-5/16" O.D. x 2-5/32" L

S.E.E.S. #	O.E.M. #	Resistance
WC-71	X19YG01	5790
WC-73	X19YG03	104
WC-74	X19YG04	1.8
WC-75	X19YG05	0.0066
WC-76	X19YG06	0.0166
WC-77	X19YG07	0.0025
WC-78	X19YG08	4.4

13/32" I.D. x 1-5/16" O.D. x 2-5/32" L

S.E.E.S. #	O.E.M. #	Volts	Resistance
WC-66	K52401	125 VDC	583

Door Parts and Equipment

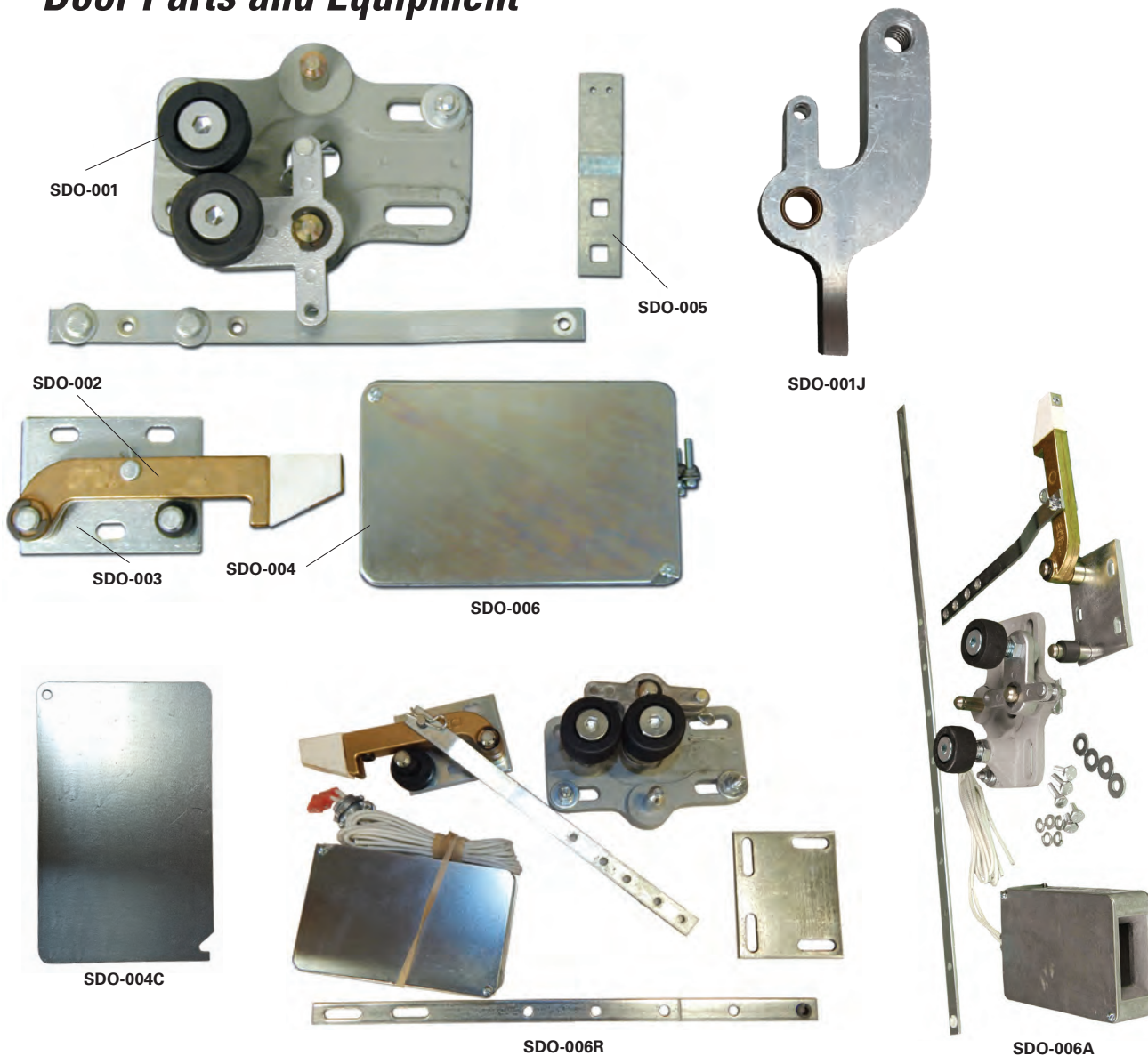

S.E.E.S. #	O.E.M. #	Description
SDO-001	5226D09H20	Universal Pick-Up Roller Base Assembly
SDO-001J		Actuator Assembly
SDO-001T		Pivot Arm, T-Section for Pick Up Assembly
SDO-002	5226D09H11	Interlock Hook, Hook assembly with nose piece
SDO-003		Bracket, universal, 3-1/4" L x 2-1/2" W x .20" H
SDO-003A	890-3013	Beak Assembly, Hook and Bracket Complete, L.H. or R.H.
SDO-004	5226D09H15	Interlock Box Assembly, with contacts
SDO-004C		Cover only for SDO-004 Interlock
SDO-005		Bracket for spirator, 4-3/4" L x 1" W x .10" H
SDO-006		Door Interlock Kit, 27" L.H., includes SDO-007, SDO-009, SDO-012, SDO-015, SDO-016, SDO-17 and SDO-018
SDO-006A	5226D09H03	Door Interlock Kit, 27" R.H., includes SDO-009, SDO-010, SDO-012, SDO-015, SDO-016, SDO-017 and SDO-018
SDO-006R	890-3000-1R 5226D09H01	Interlock Assembly, "A" link, center parting, 33"- 39" R.H.



Door Parts and Equipment



S.E.E.S. #	O.E.M. #	Description
SDO-007	5226D09H16	Linkage, door roller, long, 15-1/2"
SDO-008	5226D09H18	Pickup roller assembly, for SDO-001, with shaft and hardware
SDO-008S		Shaft, for pickup roller
SDO-008B	611010220	Roller/Axle Assy, 30mm x 10mm for Schindler QKS9, D30
SDO-008W	5226D09H18	Chain Tension Roller, White Includes Ret. Ring and Speed Nut
SDO-009	5226D09H12	Linkage Arm Kit, off set, for 15-1/2" & 27" assemblies
SDO-010	5226D09H17	Linkage, long, 27"
SDO-011	5226D09H19	Screw, roller stem
SDO-012	5226D09H09	Bumper, beak plate
SDO-013	5226D09H14	Collar Bushing, back plate
SDO-014	890-3004	Contact Block, interlock box
SDO-015	896-2002	Hitch Pin Clip, for beak assembly
SDO-016	896-2005	Nyliner Bushing, for beak assembly
SDO-017	896-1012	Hitch Pin, for beak assembly
SDO-018	890-3011	EXT "C" Ring Clip, for beak assembly
SDO-019	895-3014	Chain tension assembly, QKS-14 door operator
SDO-020	895-3012	Motor Sprocket, QKS-14 door operator, 15 teeth
SDO-20A	895-3013	Operator Chain, for QKS-14 57" Long, 3/8" Pitch
SDO-021	895-3007	Motor Belt Pulley, QKS-14 door operator (small one)
SDO-022	895-3008	Motor Belt Pulley, QKS-14 door operator (large one)
MDO-1	5207D42H46	V-Belt, 4L550 (EZ/QKS-14/15 door operator)
SDO-028	692B997H03	Encoder, optical 47PPR, 5 VDC
SDO-029	692B997H04	Encoder, optical 104PPR, ACVF

Door Parts and Equipment

S.E.E.S. #	O.E.M. #	Description
SDO-030R	894-3001-1R	Gate Switch Assembly, Schindler, Right hand
SDO-030L	894-3001-1L	Gate Switch Assembly, Schindler, Left hand
SDO-031	894-3004	Movable Contact, Schindler gate switch
SDO-032	894-3006	Stationary Contact, Schindler gate switch
SDO-051	693B440H02	Drive Pulley, for QKS-16 Door Operator
SDO-052	7269C23H03	Pulley, Sheave, for Telescopic Jack 330A
SDO-18	6994C01G01	Slotted "C" Linkage Assembly
SDO-185	6994C01G01	Door Lock Link Assembly, 330A Clutch Assembly
SDO-186	1000-3026	Slotted "C" Linkage Assembly
SDO-187	1000-3025	Tapped "C" Linkage Assembly



SDO-030R



SDO-031



SDO-032



WDO-61G



SDO-185



WDO-61HA



WCB-55A

S.E.E.S. #	O.E.M. #	Description
WDO-61G	692B863G01,	Door Operator Motor, 1/6 HP, 1150 RPM, 170 VDC, permanent magnet, flange mount
WDO-61H	7283C05H02	Door Operator Motor, 1/3 HP, 1725 RPM, 180 VDC, permanent magnet WDO-61HA Pulley, for WDO-61H
WDO-61HA	5203D67H08	Pulley, for WDO-61H door operator motor
WDO-61J	7285C56H01	Door Motor, QKS-14 1/6 HP, 1140 RPM 170 VDC foot mounting
MDO-1	5207D42H46	V-Belt, 4L550 (EZ/QKS-14/15 door operator)
WCB-55A		Carbon Brush, 1/4" x 3/8" x 1/2" with 7/8" long spring for WDO-61J



WDO-61J

Controller Equipment

SEES#	O.E.M. #	Description
SPR-001	1320B08H01	Three Phase Voltage Monitor, 208-240 VAC
SPR-002	1320B08H02	Three Phase Voltage Monitor, 400-480 VAC
SPR-003	7264C46H01	Power Supply, plug in 5 VDC



SPR-001



SPR-003



Door Parts and Equipment



WDO-1



WDO-2



WDO-4



WDO-4A



WDO-5



WDO-6



WDO-7



WDO-8



WDO-9

Type B2 Interlocks

S.E.E.S. #	O.E.M. #	Description
WDO-1		Base for contact
WDO-2	R3620G03	Contact assembly, "make"
WDO-3	R3620G04	Contact assembly, "break"
WDO-3A	R3620G01	Contact and base assembly, complete with 2 "make" contacts
WDO-4	K7028H01, K3244G01	Roller arm assembly complete
WDO-4A		Bolt for WDO-4A assembly
WDO-5	K7028H01	Arm, alone for WDO-4 assembly
WDO-6	K3244G01	Roller, alone for WDO-4 assembly, 1-1/2" O.D., 3/8" I.D., 1/4" Thickness, 1/2" overall, rubber
WDO-7	K5957H02, R6952H10	Complete block contact bridge assy. includes WDO-8 and WDO-9
WDO-8	K5957H02	Bridging block, alone
WDO-9	R6952H10	Contact bridge
WDO-10	145A765H01	Latch insulator



WDO-10



WDO-20



WDO-21

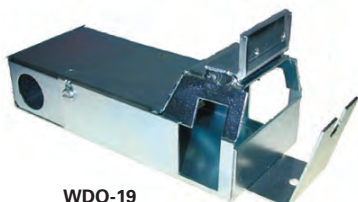

WDO-19

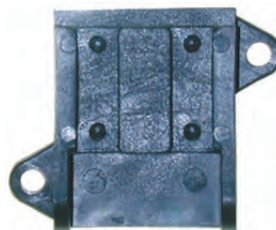

WDO-22

Types E, E1 Interlocks

S.E.E.S. #	O.E.M. #	Description
WDO-19	465D864G01	Interlock assembly
WDO-20		Support for contact WDO-21
WDO-21	144A568G01	Finger contact with silver tip
WDO-22	215B687H01	Base for stationary contact

Door Parts and Equipment



Types E and E1 Interlocks

S.E.E.S. #	O.E.M. #	Description
WDO-11	576B812H01	Nylon drive block, for E1, 3-3/4" L
WDO-12	630B424H01	Nylon drive block, for E1 and E5
WDO-13	151B776H01	Short drive block with retractable vane, 3-7/8" L, for E1
WDO-14	151B671H01	Long drive block with stationary vane, 4-9/32" L, for E1

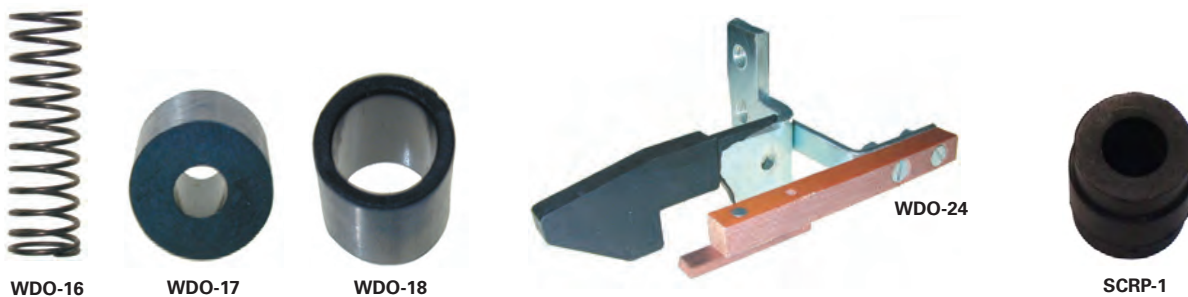
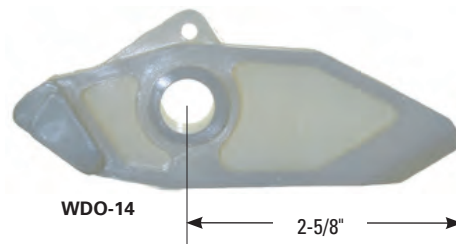

S.E.E.S. #	O.E.M. #	Description
WDO-16	X9JS1H18	Spring for latch arm
WDO-17	X14BS1H04	Rubber bumper for type E
WDO-18	X14BS1H05	Rubber sleeve for type E
WDO-24	324C463G06	Complete latch lever, L.H. for E1 Interlock
WDO-25	324C463G05	Complete latch lever, R.H. for E1 Interlock
WDO-26	144A563H02	Complete latch lever, L.H. for E Interlock
WDO-27	144A563H01	Complete latch lever, R.H. for E Interlock
WDO-28	576B807G01	Contact bridge, for latch lever, Type E1
WDO-29	144A520G01	Contact bridge, for latch lever, Type E
SCR-1		Rubber Cushion, 40/37mm x 45mm ID:20mm





Door Parts and Equipment



WDO-12



WDO-49



WDO-48

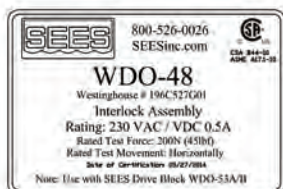

WDO-52



WDO-53



WDO-53A



WDO-53C



WDO-53D



WDO-53E



WDO-53G



WDO-56



WDO-56A

Type E5 and E5A Interlocks

S.E.E.S. #	O.E.M. #	Description
WDO-12	630B424H01	Nylon drive block, 3-9/16"
WDO-48	196C527G01	Interlock complete assembly, E5 and E5A, R.H. or L.H.
WDO-48D		Cover alone for interlock
WDO-49	682A227G01	Contact blade with silver tip
WDO-52	864A963H01	Separator/insulator
WDO-53	682A244H01	Nose and contact assembly, R.H. (shown)
WDO-53A	5194D85G01	Complete drive block assembly complete, R.H. (shown)
WDO-53B	5194D85G02	Complete drive block assembly complete, L.H.
WDO-53C	5212D87G05	Interlock Assembly, R.H., includes WDO-53A + WDO-48
WDO-53D	5212D87G01	Interlock Assembly, L.H., includes WDO-53B + WDO-48
WDO-53E	5212D87G05	Interlock A Kit, WDO-53A & WDO-48 & WDO-53G
WDO-53F	5212D87G01	Interlock A Kit, WDO-53B & WDO-48 & WDO-53G
WDO-53G		Interlock A Hardware kit shims and bolts
WDO-54	682A245G01	Nose and contact assembly, L.H.
WDO-56	X9KS1H02	Spring, 7/16" I.D. x 1-7/8" long
WDO-56A		Spring
WDO-56B	865A388H01	Spring, loop 4-1/8" long
WDO-66	X9FS1H07	Spring

Door Parts and Equipment

Drive Block – Polyurethane

S.E.E.S. #	O.E.M. #	A	B
WDO-30	M3393H01	1"	5-1/2"
WDO-31	M3639H01	1"	8"
WDO-32	R9314H01	1-5/8"	10"
WDO-32A	M6845H01	1-5/8"	8"

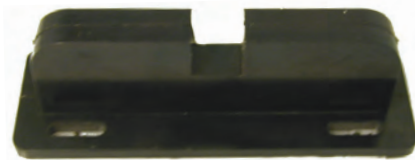
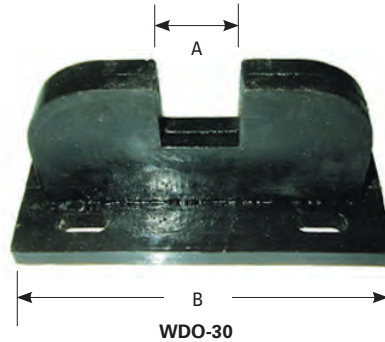

WDO-31

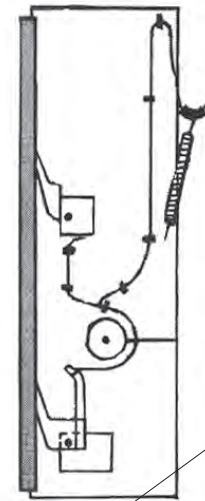
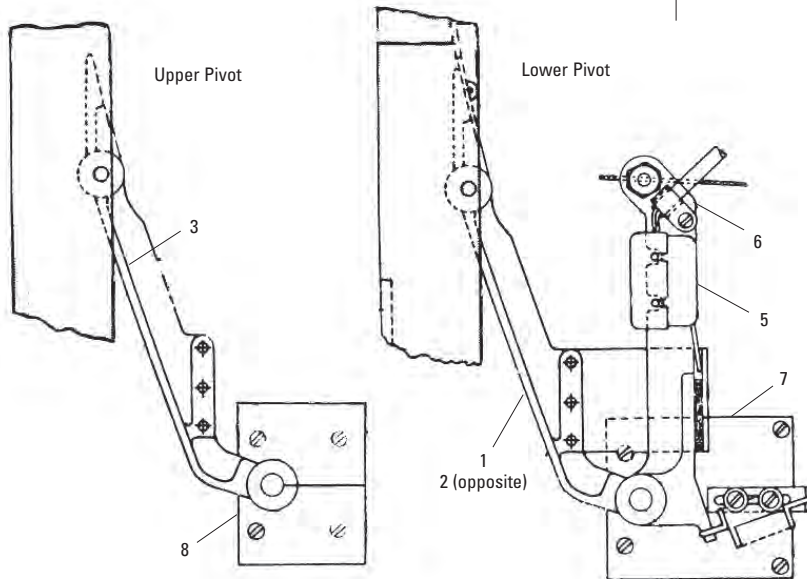
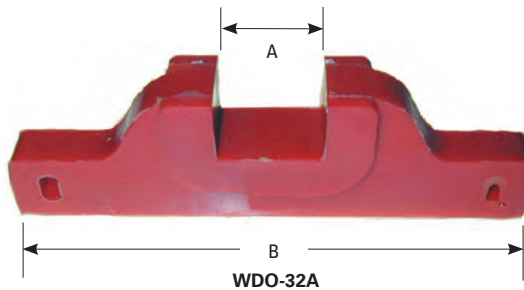

Detail for E and BB2 Operators



WDO-62

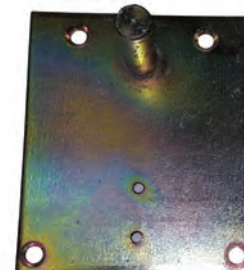

WDO-35A

Safety Edge Type SE3

Fig.	S.E.E.S. #	O.E.M. #	Description
1	WDO-35C	465D041G01	Lower pivot arm assembly, L.H.
2	WDO-35D	465D041G02	Lower pivot arm assembly, R.H.
3	WDO-35F	320C901G01	Upper pivot arm assembly, R.H. & L.H.
4	WDO-35	320C905G01	Safety edge retracting unit, 5-1/2" O.D.
5	WDO-62	144A026H03	Micro Switch
6	WDO-35E	320C902G01	Retractor arm, Reversible R.H. & L.H.
7	WDO-35A	215B305G01	Lower pivot bracket
8	WDO-35B	215B306G01	Upper pivot bracket



Door Parts and Equipment



WDO-34



WDO-34A



WDO-34B



WDO-41



WDO-42



WDO-40

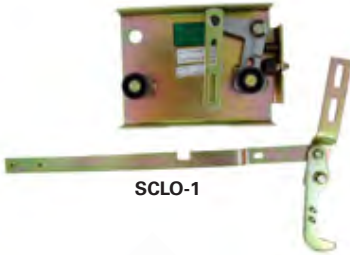

SCLO-1



WDO-43



WDO-44



WDO-45



WDO-46



SCLO-4



SCLO-9



SCLO-10



SCLO-10A

S.E.E.S. #	O.E.M. #	Description
MIS-124		Spirator, reel, 5" O.D. with combo hub
WDO-34	576B615H01	Spirator, closing reel 6" diameter with cable
WDO-34A		Bracket and Hardware, for WDO-34 or MIS-124
WDO-34B	811C418G01	Kit, Spirator (MIS-124) and Hardware (WDO-34A)

■ Two locating holes in spirator plastic center bushing.

S.E.E.S. #	O.E.M. #	Description
WDO-40	K3802G01	Movable contact, 4-1/2" L
WDO-40A	K3188G01	Movable contact, 5-3/4" L
WDO-41	R7512G01	Stationary contact, tip 1/4" diameter
WDO-42		Square cable stud clamp bolt, 3/4", 1/2-20 threaded
WDO-43		Cable stud eye clamp, 3/4" diameter, 1/2-20 threaded
WDO-44	K32682	Cable stud eye clamp, 3/4" diameter, 3/8-16 threaded
WDO-45	R80263	Cable stud pin, 1/2" diameter, 3/8-16 threaded
WDO-46	R80261	Square clamp bolt stud, 3/4" diameter, 3/8-16 thread



SCDV-1

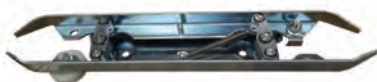

SCDV-2



WDO-48A

WDO-48B



WDO-48C

SCLO-1	Z134148	Lock, for Door QKS9(PB260) 1 left + 1 right
SCLO-4		Lock, for Door AD9
SCLO-9		Opening Device
SCLO-10		Contact, for PB16D Door Lock Goods Lift
SCLO-10A		Contact, Door Lock PB16D (Double Prong)
SLS-1	418482	Level Switch, MSR B1 C, 41 8 482/481

SCDV-1		Door Vane, for PB51
SCDV-2		Door Vane, for V30

S.E.E.S. #	O.E.M. #	Description
WDO-48A	197C534H01	Bracket double bend
WDO-48B	197C567H01	Bracket single bend
WDO-48C	197C534H03	Bracket triple bend

Oil Can

S.E.E.S. #	Description
SCOC-1	Oil Can, for Schindler Elevator

Door Parts and Equipment

S.E.E.S. #	O.E.M. #	Description
WDO-57	569A884H01	Lunar key, 6" long, stainless steel
WDO-58	W-824T	T-key used for interlock, 9" long
WDO-58E	W-824T-E	T-Key, Extended 15" OAL
WDO-57A		Escutcheon plate for lunar key, S.S., self-adhesive
WDO-57B		Escutcheon plate for "T" key, 7/8" face nickel finish with locking push nut
WDO-57AB		Escutcheon, bronze lunar 1-1/2" O.D.
WDO-49	682A227G01	Contact blade with silver tip
WDO-50	682A302H01	Contact blade support
WDO-51	682A226H01	Base for stationary contacts, for type "E5" interlock
WDO-57C		Escutcheon, Door Sleeve for lunar key



WDO-51



WDO-57C



SCDS-1



WDO-57



WDO-58



WDO-57A



WDO-57B



WDO-50



WDO-49



SCDS-2



SCDS-3



SCDS-4



WDO-59A

S.E.E.S. #	Description
SCDS-1	Door Gib
SCDS-2	Door Gib
SCDS-3	Door Gib, for 300P 22mm x 18mm x 11mm
SCDS-4	Door Gib, Rubber
SCDS-5	Plastic Door Slide

Door Gib Assemblies

S.E.E.S. #	O.E.M. #	Description
WDO-59	146A746H01	Nylon gib refill for WDO-59B and C, 4" long x 15/32" wide
WDO-59A		Offset door gib with 1/2" offset 3-1/2" long
WDO-59A-K	691B971H01	Gib Kit, WDO-59A + WDO-59 1/2" Offset Brkt w/ Nylon Gib
WDO-59B	576B681H01	Solid gib bracket, 4" long x 2-1/2" wide, with 1/16" offset, uses gib WDO-59
WDO-59B-K		Gib Kit, WDO-59B + WDO-59
WDO-59C	691B971H01	Solid gib bracket, 4" long x 2-1/2" wide, straight, no offset, uses gib WDO-59
WDO-59C-K	691B971H01	Kit (WDO-59C and WDO-59)
WDO-59C-SS	691B971H01	Gib Bracket Straight 304SS 4" L x 2-1/2" Wide, stainless steel
WDO-59C-SS-K		Kit, WDO-59C-SS and WDO-59 Bracket and Gib, stainless steel
WDO-59D	691B971H05	Offset gib bracket, 1/4" x 4" long
WDO-59D-K	691B971H01	Gib Kit, WDO-59D + WDO-59 1/4" Offset Brkt w/ Nylon Gib
WDO-59E	576B68H01	Offset gib bracket, 5/16" x 4" long Type 1 Offset
WDO-59E-K		Gib kit, WDO-59E + WDO-59 5/16" Offset Brkt w/ Nylon Gib
WDO-59F		Door Gib, .66" W slot x 7.03" L
WDO-59G		Solid Gib Bracket, 1/8" Offset 3-1/2" Lg w/ Gib Insert & hdw



WDO-59F



WDO-59A-K



WDO-59B



WDO-59B-K



WDO-59C-K



WDO-59C-SS-K



WDO-59C



WDO-59C-SS-K



WDO-59D



WDO-59D-K



WDO-59E



WDO-59E-K



Door Parts and Equipment



WDO-59H



WDO-59J



WDO-67

Door Gib Assemblies

S.E.E.S. #	O.E.M. #	Description
WDO-59H		Gib Assy, 5/8" Offset x 4" W 1-1/2" Deep, with Gib
WDO-59J		Mounting Hardware for WDO-59 Series, Pack of 50 screws
WDO-59K	W905	Door Gib, 4" No Offset with Insert, (3) Hole, nylon gib with hardware
WDO-67	195C978H01	Safety Gib

SEES-ENFORCER-001
7/16"



SEES-ENFORCER-002
15/32"

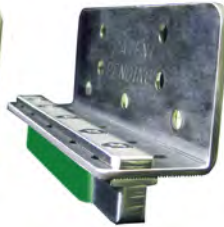

SEES-ENFORCER-003
1/2"



SEES-ENFORCER-004
17/32"



SEES Enforcer Door Gib Kits

S.E.E.S. #	Description
SEES-ENFORCER-001	SEES Safety Door Guide, Heavy Duty, Stainless Steel, Adjustable guide, with 7/16" nylon gib
SEES-ENFORCER-002	SEES Safety Door Guide, Heavy Duty, Stainless Steel, Adjustable guide, with 15/32" nylon gib
SEES-ENFORCER-003	SEES Safety Door Guide, Heavy Duty, Stainless Steel, Adjustable guide, with 1/2" nylon gib
SEES-ENFORCER-004	SEES Safety Door Guide, Heavy Duty, Stainless Steel, Adjustable guide, with 17/32" nylon gib
SEES-ENFORCER-010	SEES Safety Door Guide, Heavy Duty, Stainless Steel, Adjustable guide, with 23/64" nylon gib
SEES-ENFORCER-GIB-010	Replacement Door Gib, Nylon, 23/64" wide
SEES-ENFORCER-HDW	Bag Of 50 Mounting Screws for Enforcer Door Gib
SEES-ENFORCER-LP-R	SEES Safety Door Guide, Stainless Steel, Low Profile (Red) Adjustable guide, w/ 7/16" nylon gib



SEES Enforcer EDGE



SEES-ENFORCER-EDGE-G

S.E.E.S. #	Description
SEES-ENFORCER-EDGE-G	SEES Safety Door Guide, Stainless Steel, 0"-5/16" Offset with Green 15/32" Gib
SEES-ENFORCER-EDGE-R	SEES Safety Door Guide, Stainless Steel, 0"-5/16" Offset with Red 7/16" Gib
SEES-ENFORCER-EDGE-W	SEES Safety Door Guide, Stainless Steel, 0"-5/16" Offset with White 1/2" Gib
SEES-ENFORCER-EDGE-B	SEES Safety Door Guide, Stainless Steel, 0"-5/16" Offset with Blue 17/32" Gib

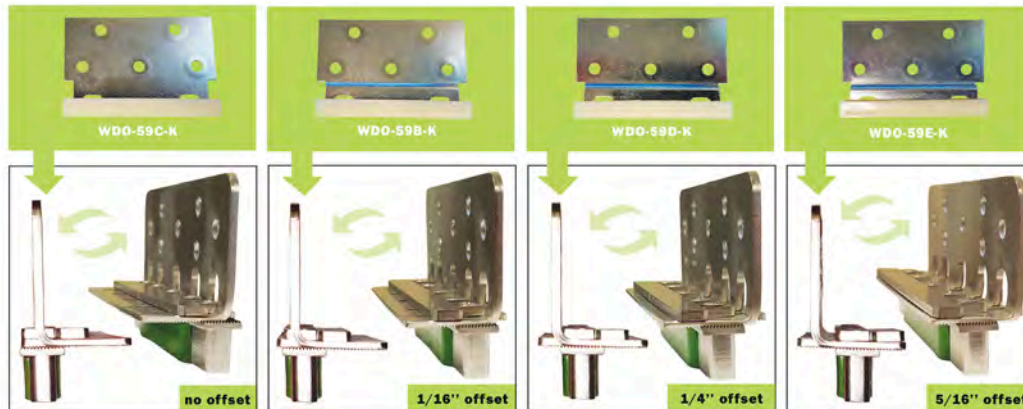

Door Parts and Equipment

Single Slide or Two Speed Applications

Used On ECI 895 and all GAL Door Operators

S.E.E.S. #	O.E.M. #	Description
SDO-101	892-3006	Door Clutch, 30" to 34"
SDO-102	892-3008	Door Clutch, 35" to 39"
SDO-103	892-3012	Door Clutch, 45" to 54"
SDO-104	892-30**	Door Clutch, 55" +
SDO-129	892-5006-LH	Door Clutch, L.H., 30" to 34"
SDO-130	892-5008-LH	Door Clutch, L.H., 35" to 39"
SDO-131	892-5010-LH	Door Clutch, L.H., 28" to 29" and 40" to 44"
SDO-132	892-5012-LH	Door Clutch, L.H., 45" to 54"
SDO-133	892-50**-LH	Door Clutch, L.H., 55" +
SDO-134	892-5006-RH	Door Clutch, R.H., 30" to 34"
SDO-135	892-5008-RH	Door Clutch, R.H., 35" to 39"
SDO-136	892-5010-RH	Door Clutch, R.H., 28" to 29" & 40" to 44"
SDO-137	892-5012-RH	Door Clutch, R.H., 45" to 54"
SDO-138	892-50**-RH	Door Clutch, R.H., 55" +

■ SDO-101 Thru SDO-104 Does Not Include Restrictor Assembly

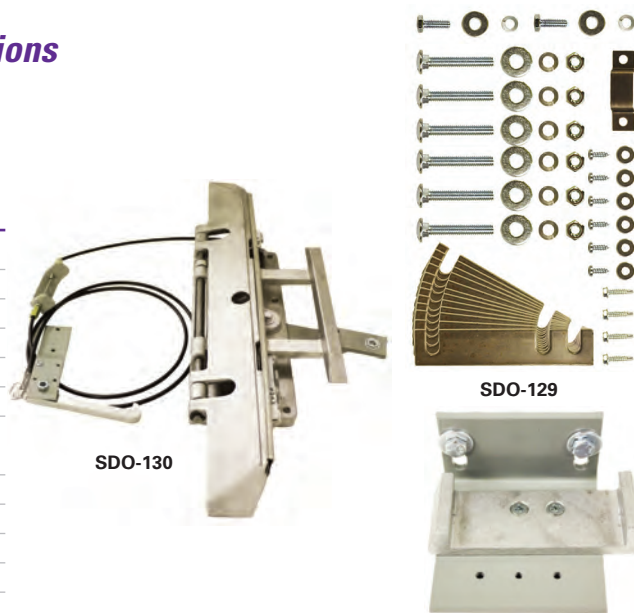

Used On ECI 1000/1010 & MCE Smartraq Door Operators

S.E.E.S. #	O.E.M. #	Description
SDO-105	892-4006	Door Clutch, 30" to 34"
SDO-106	892-4008	Door Clutch, 35" to 39"
SDO-107	892-4010	Door Clutch, 28" to 29" & 40" to 44"
SDO-108	892-4012	Door Clutch, 45" to 54"
SDO-109	895-40**	Door Clutch, 54" +
SDO-158	892-6006-LH	Door Clutch, L.H., 30" to 34"
SDO-159	892-6008-LH	Door Clutch, L.H., 35" to 39"
SDO-160	892-6010-LH	Door Clutch, L.H., 28" to 29" & 40" to 44"
SDO-161	892-6012-LH	Door Clutch, L.H., 45" to 54"
SDO-162	892-60**-LH	Door Clutch, L.H., 55" +
SDO-163	892-6006-RH	Door Clutch, R.H., 30" to 34"
SDO-164	892-6008-RH	Door Clutch, R.H., 35" to 39"
SDO-165	892-6010-RH	Door Clutch, R.H., 28" to 29" & 40" to 44"
SDO-166	892-6012-RH	Door Clutch, R.H., 45" to 54"
SDO-167	892-60**-RH	Door Clutch, R.H., 55" +
SDO-1010	ECI1010	Door Operator, ECI-1010 L.H. or R.H.
SDO-1010CP	ECI1010CP	Door Operator, ECI-1010 L.H. or R.H., Center Parting

■ SDO-105 Thru SDO-109 Does Not Include Restrictor Assembly

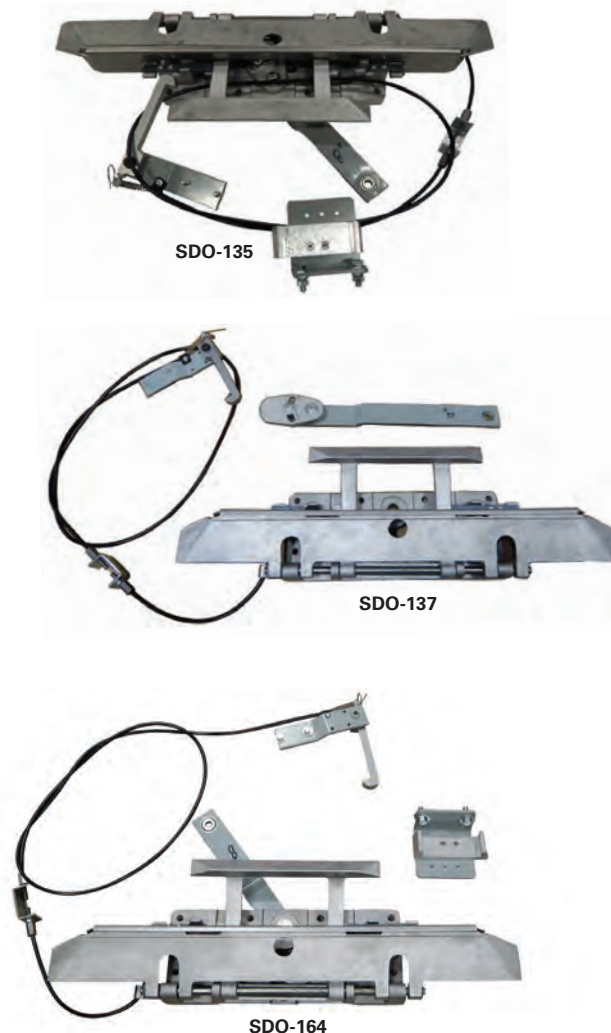

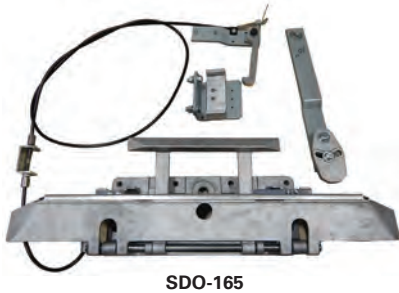

SDO-165



SDO-166



SDO-175



SDO-176

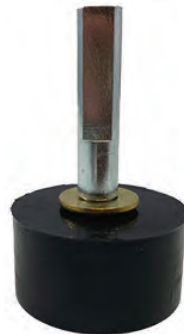

SDO-066



SDO-062

Used On VFE2500 Harmonic Door Operators

S.E.E.S. #	O.E.M. #	Description
SDO-110	892-8006-1	Door Clutch, 30" to 34"
SDO-111	892-8008-1	Door Clutch, 35" to 39"
SDO-112	892-8010-1	Door Clutch, 28" to 29" & 40" to 44"
SDO-113	892-8012-1	Door Clutch, 45" to 54"
SDO-114	892-80**-1	Door Clutch, 55" +
SDO-143	892-8006-LH	Door Clutch, L.H., 30" to 34"
SDO-144	892-8008-LH	Door Clutch, L.H., 35" to 39"
SDO-145	892-8010-LH	Door Clutch, L.H., 28" to 29" & 40" to 44"
SDO-146	892-8012-LH	Door Clutch, L.H., 45" to 54"
SDO-147	892-80**-LH	Door Clutch, L.H., 55" +
SDO-148	892-8006-RH	Door Clutch, R.H., 30" to 34"
SDO-149	892-8008-RH	Door Clutch, R.H., 35" to 39"
SDO-150	892-8010-RH	Door Clutch, R.H., 28" to 29" & 40" to 44"
SDO-151	892-8012-RH	Door Clutch, R.H., 45" to 54"
SDO-152	892-80**-RH	Door Clutch, R.H., 55" +

■ SDO-110 Thru SDO-114 Does Not Include Restrictor Assembly

All ECI Door Operators

S.E.E.S. #	O.E.M. #	Description
SDO-115	892-3008-LD	Door Clutch, 28" +
SDO-157	892-6008-LD	Door Clutch, 28" +

■ SDO-115 Does Not Include Restrictor Assembly

Restrictor Parts

S.E.E.S. #	O.E.M. #	Description
SDO-175	892-3029	Keeper and Hook, Assembly Complete
SDO-175A	892-3023	Hook assembly only
SDO-175B	892-3026	Keeper assembly only
SDO-176	892-3021	Cable, Clutch Restrictor
SDO-177	892-3004	Door Vane, Replacement for ECI Door Clutches

330A Hydro Entrance Header

S.E.E.S. #	O.E.M. #	Description
SDO-060R	5226D09H26	Interlock Assy, R.H. 330A Hydro Entrance Header
SDO-060L	5226D09H15	Interlock Assy, L.H. 330A Hydro Entrance Header
SDO-061R	6997C32G01	Drive Block Assy, R.H. 330A Hydro Entrance Header
SDO-061L	6997C32G02	Drive Block Assy, L.H. 330A Hydro Entrance Header
SDO-062	7262C37G02	Spirator Assembly, Phase II 330A Hydro Entrance Header
SDO-063	6993C54G01	Interlock Bracket Assy, 330A Hydro Entrance Header
SDO-065	962718	Encoder Pulley with Magnet Assembly
SDO-066	6993C81H01	Drive Block Roller. 330A
SDO-067	5062A95H01	Bumper for 330A Drive Block
SDO-068	5062A98H01	Latch Bumper for 330A Drive Block

Door Parts and Equipment

Center Parting Applications

Used On ECI 895 and all GAL Door Operators

S.E.E.S. #	O.E.M. #	Description
SDO-116	892-3005-CO	Door Clutch, door opening from 29" to 33"
SDO-117	892-3006-CO	Door Clutch, door opening from 34" to 49"
SDO-118	892-3008-CO	Door Clutch, door opening from 50" to 54"
SDO-119	892-30**-CO	Door Clutch, door opening from 55" +
SDO-139	892-5006-CO	Door Clutch, door opening from 29" to 33"
SDO-140	895-5006-CO	Door Clutch, door opening from 34" to 49"
SDO-141	892-5008-CO	Door Clutch, door opening from 50" to 54"
SDO-142	892-50**-CO	Door Clutch, door opening from 55" +

■ SDO-116 Thru SDO-119 Does Not Include Restrictor Assembly

Used On ECI 1000/1010 & MCE Smartraq Door Operators

S.E.E.S. #	O.E.M. #	Description
SDO-120	892-4005-CO	Door Clutch, door opening from 30" to 33"
SDO-121	892-4006-CO	Door Clutch, door opening from 34" to 49"
SDO-122	892-4008-CO	Door Clutch, door opening from 50" to 54"
SDO-123	892-40**-CO	Door Clutch, door opening from 54" +
SDO-168	892-6005-CO	Door Clutch, door opening from 29" to 30"
SDO-169	892-6006-CO	Door Clutch, door opening from 31" to 49"
SDO-170	892-6008-CO	Door Clutch, door opening from 50" to 54"
SDO-171	892-60**-CO	Door Clutch, door opening from 55" +

■ SDO-120 Thru SDO-123 Does Not Include Restrictor Assembly

Used On VFE2500 Harmonic Door Operators

S.E.E.S. #	O.E.M. #	Description
SDO-124	892-8005-1CO	Door Clutch, door opening from 29" to 33"
SDO-125	892-8006-1CO	Door Clutch, door opening from 34" to 49"
SDO-126	892-8008-1CO	Door Clutch, door opening from 50" to 54"
SDO-127	892-8008-1CO	Door Clutch, door opening from 55" +
SDO-153	892-8005-CO	Door Clutch, door opening from 29" to 30"
SDO-154	892-8006-CO	Door Clutch, door opening from 31" to 49"
SDO-155	892-8008-CO	Door Clutch, door opening from 50" to 54"
SDO-156	892-80**-CO	Door Clutch, door opening from 55" +

■ SDO-124 Thru SDO-127 Does Not Include Restrictor Assembly

All ECI Door Operators

S.E.E.S. #	O.E.M. #	Description
SDO-128	892-8008-1CO	Door Clutch, door opening from 29" +

■ SDO-128 Does Not Include Restrictor Assembly

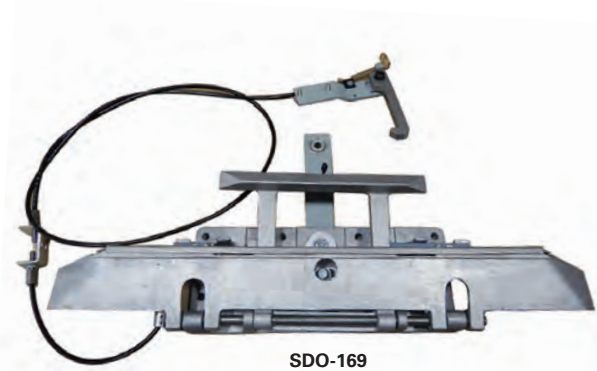



Door Parts and Equipment

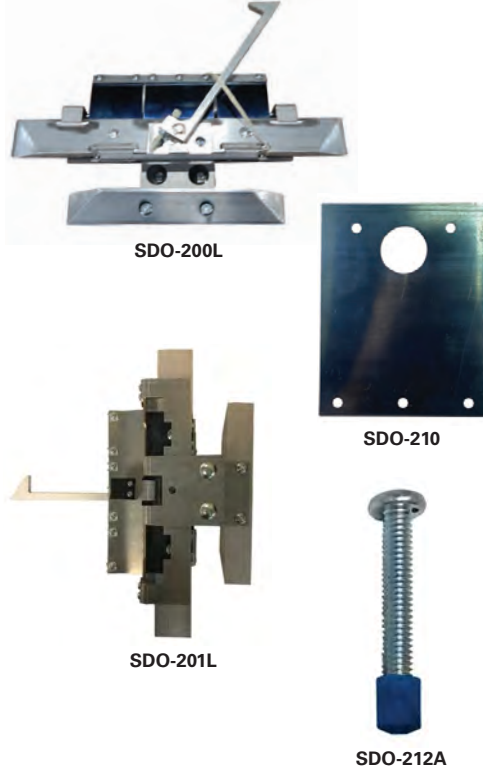

Used on 330A Door Operators

S.E.E.S. #	O.E.M. #	Description
SDO-200L	8535C72G02	Clutch Assembly, L.H., 330A SSSO/SSCO
SDO-200R	8535C72G01	Clutch Assembly, R.H., 330A SSSO/SSCO
SDO-201L	8535C72G04	Clutch Assembly, L.H., 330A 2SSO
SDO-201L	8535C72G04	Clutch Assembly, L.H., 330A 2SSO
SDO-201R	8535C72G03	Clutch Assembly, R.H., 330A 2SSO
SDO-202L	8535C72G02	Vane Assembly, L.H., 330A Clutch
SDO-202R	8535C72G02	Vane Assembly, L.H., 330A Clutch
SDO-203	5065A51H01	Retractor Ramp for QKS-16/330A Clutch
SDO-204	5062A92H01	Ramp Shim .060" for QKS-16/330A Clutch
SDO-205	8535C67G03	Actuator Assembly, for 330A Clutch
SDO-206	8535C66H01	Actuator Plate for 330A Clutch
SDO-207	8535C69H01	Open Vane for 330A Clutch
SDO-208	5265A52H01	Spring Hinge, 330A Clutch
SDO-209	8535C70H01	Boot Spacer for QKS-16/330A Clutch
SDO-210	6993C86H02	Center Spring for 321A/330A Clutch
SDO-211	6993C86H01	Outer Spring for 321A/330A Clutch
SDO-212		Replacement Screw, 1/4-20 x2" Nylon Rnd Hd for 330A Clutches, Bag of 5
SDO-212A		Upgraded Screw, 1/4-20 x 2" Steel Zinc Rnd Hd with Urethence tip for 330A Clutches, each

Door Motors

S.E.E.S. #	O.E.M. #	Description
WDO-61	569A700H01	Door Motor, 1/6 HP, 2000 RPM, 125 VDC, 1.3 Amp, shunt wound
WDO-61F	151B420G01	Door motor, WDO-61 with pulley, 16 teeth
WDO-61G	692B863G01	Door Operator Motor, 1/6 HP, 1150 RPM, 170 VDC, permanent magnet, flange mount
WDO-61H	7283C05H02	Door Operator Motor, 1/3 HP, 1725 RPM, 180 VDC, permanent magnet WDO-61HA Pulley, for WDO-61H
WDO-61J	7285C56H01	Door Motor, QKS-14 1/6 HP, 1140 RPM, 170 VDC foot mounting
SDO-180	1000-3006	1/3 HP Motor Assembly



Door Parts and Equipment

S.E.E.S. #	O.E.M. #	Description
SDO-034	909-7000	Door Hanger Assy, ECI Roller And Eccentric
SDO-035	909-7006	Eccentric, ECI Upthrust Roller
SDO-036	909-6008	Door Roller, ECI 3-1/4" 5/8 I.D.
SDO-036A	909-6008	Door Roller, ECI 3-1/4" 6203 Brg w/ 5/8-18 Ecc. Shaft, Thin Shoulder
SDO-037	909-6045	Hanger Retainer, ECI Hall
SDO-038	909-6006	Hanger Shim Kit, ECI Door Suits 4-1/8" Pendant Bolt Ctrs
SDO-039	909-7002	Bracket, Anchor Ext
SDO-040	909-7003	Pulley Bracket, ECI Center Parting Assembly
SDO-041	909-7005	Cable Clamp Assy, ECI
SDO-042	909-6014	Cable, ECI Pulley
SDO-043	909-6023	Support Bracket, for Car door and track hangers, End
SDO-044	909-6020	Support Bracket, for Car door and track hangers, 2 Speed, Center
SDO-045	909-6027	Track Bolts, for Car door and track hangers
SDO-046	890-3025	Mounting Plate, Track Interlock, Car Lock
SDO-047	909-6007	Mounting Bracket, Hanger/Keepr
SDO-048	909-6024	Adapter Plate, Hanger/Beak
SDO-049	909-6026	Track Shims, 1/8", ECI
SDO-050	895-3003	Drive Arm, for 42" CP Opening QKS-14
SDO-175	892-3029	Keeper and Hook, Assembly Complete
SDO-175A	892-3023	Hook assembly only
SDO-175B	892-3026	Keeper assembly only
SDO-176	892-3021	Cable, Clutch Restrictor
SDO-177	892-3004	Door Vane, Replacement for ECI Door Clutches



SDO-034



SDO-035

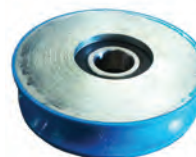

SDO-036



SDO-037



SDO-038



SDO-039



SDO-041



SDO-040



SDO-042



SDO-043



SDO-045



SDO-046



SDO-047



SDO-044

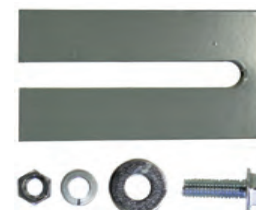

SDO-048



Door Parts and Equipment



S.E.E.S. #	O.E.M. #	Description
WDO-60	576B858G01	Door relating cable, 12' L with two studs
WDO-60A	151B465G04	Relating cable sheave nylon 2-3/4" dia. with bracket and mounting shaft
WDO-60B	682A143G01	Pulley, 2-3/8" dia. aluminum .3937 I.D., for relating cable
WDO-60C		Door relating cable, WDO-60 with poly coated cable
WDO-60D	5063A83G01	Cable kit, 8-1/2 ft long 1/8" cable with connecting hardware
WDO-60D-S		Stud, for WDO-60D with Set Screw
WDO-60D-SH		Cable Hitch, Stud Only with Flat End
WDO-60E	151B420G01	Tie bracket for AC & AC2 hangers
WDO-60F	144A883G01	Cable Assembly includes WDO-60D and E
WDO-60J	X4TS2H22	Nut, 1/2-20 Hex Serrated Flange Nut Z.P
WDO-60K	X4TS2H22	Relating Cable Kit, (2) Studs, (1) Hitch and Cable
WDO-60L	7433C88G01	Sheave Assy, Retaling Cable for Entry Doors
WDO-60-SPECIAL		Door relating cable, (cut to length)
WDO-61	569A700H01	Door Motor, 1/6 HP, 2000 RPM, 125 VDC, 1.3 Amp, shunt wound
WCB-142		Carbon Brush, for WDO-61
WDO-61A	151B419G02 5194D44G03	Drive Pulley Assembly, E4 operator, motor side cover
WDO-61B	152B124G01	Limit Switch Drive Pulley with steel bushing 1/2" hole, no flange
WDO-61C	151B419G01	Power Pulley Assembly with bronze bushing 3/4" hole with flange
WDO-61D	569A473H01	Shaft Assembly only for WDO-61
WDO-61E	144A409H01	Shaft assembly
WDO-61F	151B420G01	Door motor, WDO-61 with pulley, 16 teeth
WDO-61G	692B863G01	Door motor, 1/6 HP, 1150 RPM, 170 VDC, permanent magnet, flange mount
WDO-63	144A574H01	Door magnet
WDO-64	X11HS1H01	Bumper, 1" O.D. x .520" L, .270" stem
WDO-64A		Bumper, 1-1/4" O.D. x 15/16" L, 3/4" stem
SCWH-15		Sheave, 60 mm x x 11 mm, 6200 BRG, groove diameter: 48 mm, ID: 10 mm
SCWH-16		Sheave, 50mm x 10 mm, groove diameter: 36 mm
SDO-190		Cable, Door Relating Assembly

Door Parts and Equipment

S.E.E.S. #	O.E.M. #	Description
SDO-178	1000-3008	Motor Belt, AX53 Serrated VBelt
SDO-179	1000-3014	Chain Assembly CW Silencer Strap40
SDO-180	1000-3006	1/3 HP Motor Assembly
SDO-181	1000-3015	Chain Tension Roller Assy ECI Door Clutches
SDO-18A	1000-3015	Chain Tension Roller Only ECI Door Clutches
SDO-182L	1000-3050-1L	1010 Operator 120V CP 8' Cab 40-44" L.H.
SDO-182R	1000-3050-1R	1010 Operator 120V CP, 8' Cab 40-44" R.H.
SDO-183	5203D67H14	Chain Sprocket Assembly QKS-15 14T
SDO-184	6997C33G01	Contact Latch Assembly with Contact Replaceable Beak
F-DC-1		Door Controller, Fermator VVVF
F-BELT-1		Fermator Door Belt



SDO-178



SDO-179



SDO-180



SDO-181

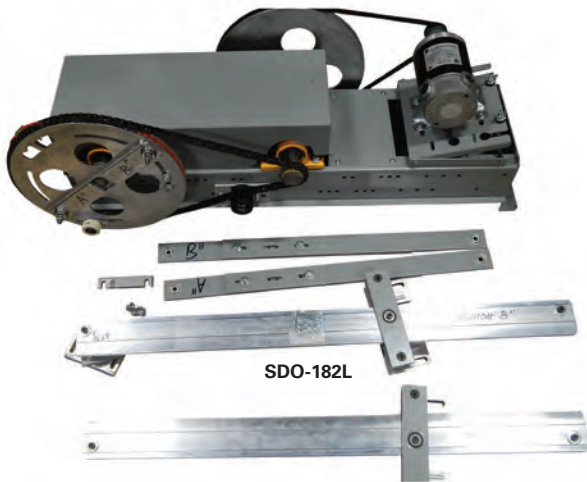

SDO-182L

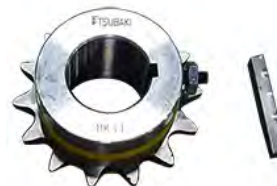

SDO-183



SDO-184

Maintenance Kits

S.E.E.S. #	O.E.M. #	Description
SMK-001A	A330A	Schindler 330A Maintenance Kit A
SMK-001B	A330B	Schindler 330A Maintenance Kit B
SMK-001C	A330C	Schindler 330A Maintenance Kit C



Electronic Components



WEC-15



WEC-54



WEC-16



WEC-18



WEC-22



WRT-1



WRT-2



WRT-3



WRT-4

Capacitors For DM Controllers

S.E.E.S. #	O.E.M. #	Description
WEC-15	576B887G02 K7344H02	Capacitor, 150 MFD, 150 VDC, 2 wires
WEC-54	CGS362T200V4C	Capacitor, 3600 MFD, 200 VDC

Capacitors For STL Relays

S.E.E.S. #	O.E.M. #	Description
WEC-16	K3412H01	Capacitor, 90-110 MFD, 125 WVDC
WEC-17	K3412H02	Capacitor, 68-82 MFD, 125 WVDC

Capacitors For EST Relays

S.E.E.S. #	O.E.M. #	Description - Time Range
WEC-18	466D034G01	Capacitor, 10 MFD, .1 to .6 Sec.
WEC-19	466D034G02	Capacitor, 50 MFD, .5 to 3.0 Sec.
WEC-20	466D034G03	Capacitor, 150 MFD, 1.5 to 9.0 Sec.
WEC-21	466D034G04	Dual time Capacitor, 10 MFD w/o diode .1 to .6 Sec. Add.
WEC-22	466D034G05	Dual time Capacitor, 20 MFD, w/o diode .2 to 1.2 Sec.
WEC-23	466D034G06	Dual time Capacitor, 50 MFD, w/o diode .5 to 3.0 Sec. Add.
WEC-24	466D034G07	Dual time Capacitor, 150 MFD, w/o diode 1.5 to 9.0 Sec. Add.
WEC-25	466D034G08	Capacitor, 20 MFD, 2 to 1.2 Sec.

■ Above capacitors are 150 VDC.

Rectifiers

S.E.E.S. #	O.E.M. #	Description
WRT-1	195C928G01, 630B077H01, 478C156G01	Three Phase Rectifier, 35A, 300 V
WRT-2	151B931G01	Rectifier solid state 20 A, 300V
WRT-3		Zener Operator, for E-4A 10V, 50 W
WRT-4	X45AS2H24	Rectifier, Zener, 130V, 1 W

Electronic Components

Tubes

S.E.E.S. #	O.E.M. #	Description
WET-1	K3827H01	Thyratron tube, 2A3
WET-2	M5509H01	Thyratron tube, 2050
WET-3	H3090H11	6570 Tube replacement. This solid state unit replaces tube 6570
WET-4	K4336H01	Tube, 1C21
WET-5		Tube, 2D21
WET-6		Tube, 12AX7A
WET-7		6012 Tube replacement kit. This solid state unit replaces electron tube 6012 on regulator
WET-7A		Tube, Electron Original #6012

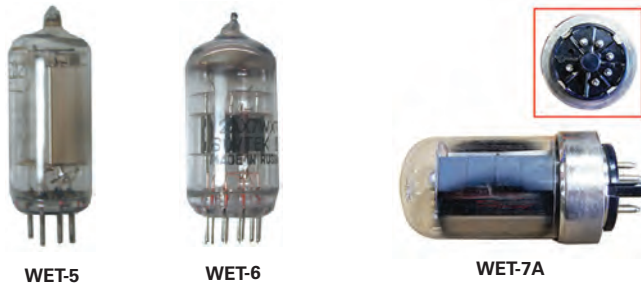

Breaker

S.E.E.S. #	O.E.M. #	Description
SCEP-3	181369	Breaker



Fans

S.E.E.S. #	O.E.M. #	Description
SCF-1	142984	Fan, for RV140 380-400V
SCF-2		Fan, for VF140, 100/220/230V, 50/60HZ, 30 Watts
SCF-3		Fan, for VF140, 220 VAC, 50/60HZ, 40 Watts





Machine Parts



S.E.E.S. # Description

- WMT-1** Thrust bearing tool for #18 Machine, 2-1/2" I.D.
- WMT-2** Thrust bearing tool for #28, #38, #57 Machine, 3-1/2" I.D.
- WMP-105** Visual Inspection Plate, general mach #28, 38, 57, 61

#18 Machine

103D907,103D899

S.E.E.S. # O.E.M. # Description

WMP-1	195C574H02	Hand hole gasket
WMP-2	195C574H01	Front cover gasket
WMP-3	195C574H04	Housing gasket
WMP-4	195C574H06	Hand hole gasket, lower
WMP-5	X18CS1H12, X6PS1H07, X4FS1H05	Kit: Thrust Bearings Lock washer Lock nut
WMP-6	630B301H01	Gasket .010, Thrust bearing end
WMP-7	630B301H05	Gasket .125, Thrust bearing end
WMP-8	630B301H02	Shim .005, pedestal
WMP-9	630B301H03	Shim .007, pedestal
WMP-10	630B301H04	Shim .020, pedestal
WMP-11	X6LS1H41	Felt washer, worm shaft, 3.25" x 1.25"
WMP-12	682A092H01	Front bearing gasket, worm shaft
WPAC-36C	X30ES1H12	Seal, pedestal, 2-9/16" x 3-3/4" x 3/8"
WPAC-36D	X30ES1H13	Seal, worm shaft, 1-3/4" x 3-3/16" x 1/2"
WMP-14	195C572G01	Plunger assembly for brake
WMP-15	X6LS2H42	Felt washer for brake, 4" x 2"
WMP-16	195C572H04	Bushing, bronze, for brake 2" O.D., 3-3/16 O.L.
WMP-17	X6AS1H27	Leather washer for brake
WC-85	X19PS1G08	Coil, for brake
WMP-23	195C615H02	Oil wiper segment
WMP-24	X9BS1H03	Oil wiper spring
WMP-25	630B301H01	Gasket, pedestal sheave side
WMP-25A	6918C45H01	Sheave seal
WMP-26	692B273H01	Filter
WMPK-1		Machine Seal, Shim and gasket kit

■ Kits do not include bearings

Machine Parts

#27 Machine

W732, W746, W768, W788

S.E.E.S. #	O.E.M. #	Description
WMP-27	R5027H03	Hand hole gasket
WMP-27A	R9172H01	Front cover gasket
WMP-28	X18CS1H06	Kit: Thrust bearing
	K3126H01	Thrust bearing washer
	X4CS1H08	Lock nut
WMP-28B		Thrust Bearing Set, #27 machine, 2 bearings
WMP-29	R7923H05	Gasket
WMP-30	R7923H03	Thrust bearing gasket
WPAC-36F	R7311H22, 23	Seal, worm shaft
WPAC-36I	X30AS1H11	Seal, pedestal (W768 & W788)
WPAC-36K	M3427H06	Seal, pedestal (W732 & W746)
WMP-31	X27AS1H11	Shim, .005, pedestal sheave side
WMP-32	X27AS1H13	Shim, .020, pedestal sheave side
WMP-33	R7920H05	Oil wiper segment
WMP-33A	R7921G01	Plunger assembly
WMP-33B	R7921H04	Bushing, 2-1/4" O.D., 3-1/8" O.L.
WMP-34	X9BS1H27	Oil wiper spring
WMP-35	M3999H06	Gasket, pedestal sheave side
WMPK-2		Machine Seal, Shim and gasket kit

■ Kits do not include bearings



Brake Parts

For Machine #s 18, 27, 28, 28A, 37, 38, 57, 58, and 61

S.E.E.S. #	O.E.M. #	Description
WMP-13	630B422H01	Micro switch
WMP-18	M3665G01	Brake switch assembly
WRP-8	R7533G04	Moving contact
WMP-20A	R7533H01	Contact plate
WMP-20B	M3455H03	Bridge plate
WMP-21	X9AS1H03	Spring
WMP-22	X12DS1H12	Pin
WMP-36	X27NS1H07	Felt washer
WRP-8	R7533G04	Brake cooling contact assy. silver



WMP-36



WMP-18

#28 and #28A Machines

534F911, 534F834

S.E.E.S. #	O.E.M. #	Description
WMP-38	X18CS1H13	Kit: Thrust bearings
	X6P9	Lock washer, Lock nut
WMP-39	215B755H02	Outer end thrustbearing cover gasket
WMP-40	215B755H01	Inner thrustbearing assembly gasket
WMP-41	R5026H09	Shim
WMP-42	M3999H04	Front bearing gasket, worm shaft
WMP-43	216B129H01	Gear housing gasket
WMP-27	R5027H03	Hand hole gasket
WMP-45	144A989H01	Front side cover gasket
WMP-46	X18D4	Bearing, pedestal sheave
WMP-47	X18D33	Bearing, gear side
WMP-48	X27AS1H03	Shim, .005, sheave side



Machine Parts

#28 and #28A Machines

534F911, 534F834

S.E.E.S. #	O.E.M. #	Description
WMP-49	X27AS1H18	Shim, .007, sheave side
WMP-50	X27AS1H04	Shim, .020, sheave side
WPAC-39A	X30ES1H19	Split Seal, worm shaft
WPAC-36B	X30ES1H15	Seal, pedestal
WMP-51	322C062H02	Oil wiper segment
WMP-24	X9BS1H03	Oil wiper spring
WMP-3	195C574H04	Housing gasket
WMP-60	M3999H06	Gasket, pedestal sheave side
WC-84	X19PS1G01	Coil, brake
WMP-53	144A523G01	Plunger assembly, brake
WMP-54	R8757H01	Bronze bushing, 2.51" I.D. 2.75" O.D., 5-1/16" O.L.
WMP-54A		Bronze worm shaft bushing for G01 assy
WMP-54B		Bronze worm shaft bushing
WMP-55	X6LS1H29	Felt washer
WMP-55A	X6AS1H19	Leather washer
WPAC-15	6917C91G02	Machine Kit, #28
WPAC-35D	6917C89H01	Sheave Seal, #28 Machine Split
WMPK-3		Machine Seal, Shim and gasket kit



WMPK-3



WPAC-15



WPAC-39A

WMP-54A

WMP-54B

WMP-63



WMPK-5

#37 Machine

WW167, WW194, WW503

S.E.E.S. #	O.E.M. #	Description
WMP-27	R5027H03	Hand hole gasket
WMP-57	R5027H15	Front cover gasket
WMP-58	X18CS1H04	Kit: Thrust bearings
	K1917H05	Lock washer
	M4202H01	Lock nut
WMP-59	R5027H05	Thrust bearing gasket
WPAC-36E	R7311H17	Seal, worm shaft
WPAC-36L	M3427H01	Seal, pedestal
WMP-35	M3999H06	Gasket, pedestal sheave side
WMP-61	R8906H02	Oil wiper segment
WMP-24	X9BS1H03	Oil wiper spring
WC-84	X19PS1G01	Coil, brake
WMP-54	R8757H01	Bronze bushing, 2.51" I.D. 2.75" O.D., 5-1/16" O.L.
WMP-55	X6LS1H29	Felt washer
WMPK-4		Machine Seal, Shim and gasket kit

#38 Machine

534F909, 534F812

S.E.E.S. #	O.E.M. #	Description
WMP-38	X18CS1H13, X6P9	Kit for 1/2" cables: Thrust bearings Lock washer, Lock nut
WMP-63	X18CS1H11	Kit for 5/8" cables: Thrust bearings
WMP-39	215B755H02	Thrust bearing end gasket
WMP-40	215B755H01	Gasket, front bearing worm shaft
WMP-41	R5026H09	Shim, thrust bearing
WMP-27	R5027H03	Hand hole gasket
WMP-64	215B690H01	Gear housing gasket
WMP-65	144A524H01	Front side gasket
WMP-66	X18DS1H11	Bearing, pedestal sheave side
WMP-67	X18DS2H35	Bearing, gear end
WMP-68	X27AS1H16	Shim, .005 pedestal sheave side
WMP-69	X27AS1H19	Shim, .007 pedestal sheave side
WMP-70	X27AS1H17	Shim, .020 pedestal sheave side
WPAC-35B	X30ES1H16	Seal, pedestal, with spring
WPAC-41A	X30ES1H18	Seal, pedestal (Type 198C267 only)
WMP-71	321C599H02	Oil wiper segment
WMP-24	X9BS1H03	Oil wiper spring
WMP-72	M3999H03	Gasket, pedestal sheave side
WC-84	X19PS1G01	Coil, brake
WMP-53	144A523G01	Plunger assembly
WMP-54	R8757H01	Bronze bushing, 2.51" I.D. 2.75" O.D., 5-1/16" O.L.
WMP-55	X6LS1H29	Felt washer
WPAC-35C		Pedestal Sheave Seal, 9.75" I.D. split lip with hole
WPAC-40A	W872E20, X30ES1H20	Seal, #38 Hoist Machine Worm
WMPK-5		Machine Seal, Shim and gasket kit

■ Kits do not include bearings

Machine Parts

#57 Machine

WW179, WW199, and WW504

S.E.E.S. #	O.E.M. #	Description
WMP-38	X18CS1H13 X6P9	Kit: Thrust bearings Lock washer, and Lock nut
WMP-74	R9115H02	Front cover gasket
WMP-75	R9115H01	Housing gasket front
WMP-76	R5027H13	Gasket, front & back worm shaft
WMP-77	R5027H02	Gasket, thrust bearing
WMP-41	R5026H09	Shim, thrust bearing
WPAC-41B	X30ES1H09	Seal, worm shaft
WPAC-36M	M3427H02	Seal, pedestal
WMP-78	R5026G01	Plunger assembly
WMP-79	R5026H06	Bushing
WMP-80	X6LS1H07	Felt washer, 5-1/2" x 3"
WMP-81	X27AS1H23	Shim, .005, pedestal sheave side
WMP-81A		Shim, .005 pedestal sheave 5/8" cable
WMP-82	X27AS2H33	Shim, .007, pedestal sheave side
WMP-82A	X27AS2533	Shim, .007 pedestal sheave 5/8" cable
WMP-83	X27AS1H22	Shim, .020, pedestal sheave side
WMP-83A	X27AS1H22	Shim, .020 pedestal sheave 5/8" cable
WMP-84	M3999H02	Gasket, pedestal
WMP-88	R9080H02	Oil wiper segment
WMP-89		Vent Valve, 1/8" NPT for Gear Case
WMP-24	X9BS1H03	Oil wiper spring
WMPK-6		Machine Seal, Shim and gasket kit

#61 Machine

W770, 626D831

S.E.E.S. #	O.E.M. #	Description
WMP-27	R5027H03	Hand hole gasket
WMP-93	R7532H07	Housing gasket front
WMP-94	X18CS1H05 K3126H03	Kit: Thrust bearings Thrust bearing washer lock nut
WMP-95	R5027H12	Gasket
WMP-41	R5026H09	Gasket, thrust end
WPAC-41B	X30ES1H09	Seal, worm shaft
WPAC-36N	M3427H05	Seal, pedestal
WMP-96	R5027H11	Front bearing gasket
WMP-97	M3999H01	Gasket, pedestal
WMPK-8		Machine Seal, Shim and gasket kit

#81 Machine

U18, 627D585

S.E.E.S. #	O.E.M. #	Description
WMP-27	R5027H03	Hand hole gasket
WMP-100	X18CS1H07 K3126H04	Kit: Thrust bearings Thrust bearing washer
WMP-102	R8384H02	Thrust bearing gasket
WPAC-36H	R7311H25	Seal, worm shaft
WPAC-36P	M3427H07	Seal, pedestal, 2.56" I.D., 3.751" O.D. 3/8" Thick
WMP-106	534F893G07	Break Bushing, Bronze
WMPK-9		Machine Seal, Shim and gasket kit

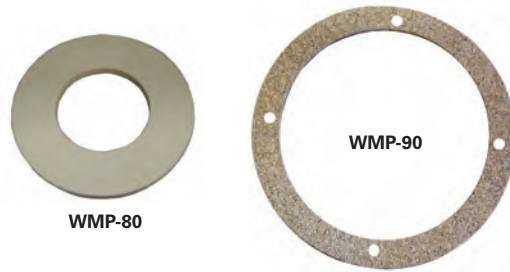

#58 Machine

S.E.E.S. #	O.E.M. #	Description
WMP-27	R5027H03	Hand hole gasket
WMP-74	R9115H02	Front cover gasket
WMP-75	R9115H01	Housing gasket
WMP-38	X18CS1H13 X6P9	Kit: Thrust bearings Lock washer Lock nut
WMP-39	215B755H02	Gasket, thrust bearing end
WMP-40	215B755H01	Front bearing gasket worm shaft
WMP-41	R5026H09	Shim, thrust bearing
WPAC-41C	X30ES1H14	Seal, worm shaft
WPAC-41	X30ES1H21	Seal, worm shaft
WPAC-41D	X30ES1H17	Seal, pedestal
WMP-90	630B352H01	Cork gasket, worm shaft
WMP-78	R5026G01	Plunger assembly, brake
WMP-79	R5026H05	Bronze bushing, brake
WMP-80	X6LS1H07	Felt washer
WMP-55A	X6AS1H19	Leather washer
WMPK-7		Machine Seal, Shim and gasket kit

■ Kits do not include bearings

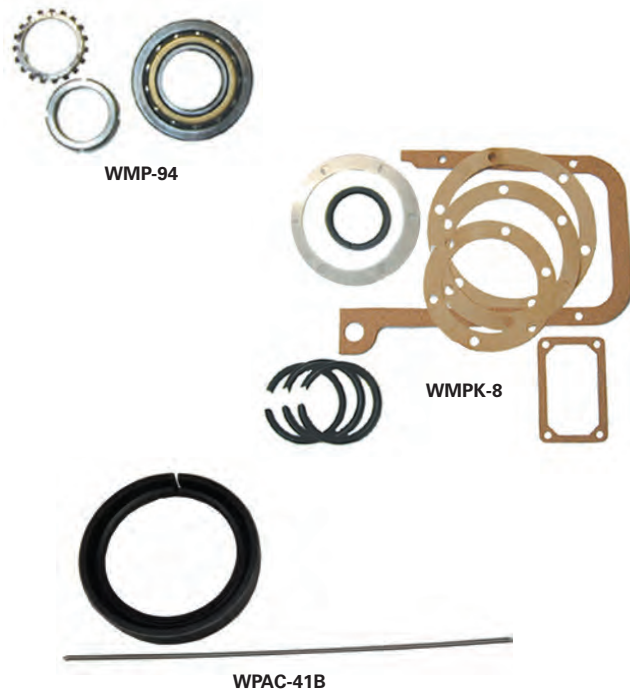



Machine Parts



Machine Seals for Traction Equipment

S.E.E.S. #	O.E.M. #	I.D. x O.D. x Thick	Application
WPAC-35C	2890C79H01	9-3/4" x 11-1/2"	#38 Worm
WPAC-35B	X30ES1H16	4 x 5" x 1/2"	#38 Gear
WPAC-36B	X30ES1H15	3-11/16" x 4-3/4" x 1/2"	#28 Gear
WPAC-36C	X30ES1H12	2-9/16" x 3-3/4" x 3/8"	#18 Gear
WPAC-36D	X30ES1H13	1-3/4" x 3-3/16" x 1/2"	#18 Worm
WPAC-36E	R7311-H17	2-7/16" x 3-7/16" x 11/16"	#35, #36, #37 Worm
WPAC-36F	R7311-H23	2-1/8" x 3-9/64" x 11/16"	#25, #26, #27, #31 Worm
WPAC-36G	R7311-H13	2.618" x 3.9375" x 11/16"	#60 Worm
WPAC-36H	R7311-H25	4" x 5" x 11/16"	#81 Worm
WPAC-36I	X30AS1H11	2.750" x 3.7495" x 1/2"	
WPAC-36J	X30AS1H08	29/32" x 1.575" x 5/16"	
WPAC-39A	X30ES1H19	2-1/2" x 3-1/2" x 7/16"	#28 Worm
WPAC-40A	X30ES1H20	3-1/8" x 4-1/4" x 1/2"	#38 Worm
WPAC-41	X30ES1H21	3-1/4" x 4-1/4" x 1/2"	#38, #57, #61 Worm
WPAC-41A	X30ES1H18	4-1/2" x 5-1/2" x 1/2"	#38 Gear
WPAC-41B	X30ES1H9	3-1/4" x 4-1/4" x 11/16"	#57, #61 (#58 old style)
WPAC-41C	X30ES1H14	3-1/4" x 4-1/2" x 5/8"	#58 (new style)
WPAC-41D	X30ES1H17	5 x 6" x 1/2"	#58 Gear

S.E.E.S. #	O.E.M. #	Description	I.D. x O.D. x Thick
WPAC-36K	M3427H06	#27 Pedestal seal	2.75" x 3.55" x 0.40"
WPAC-36L	M3427H01	#37 Pedestal seal	3.25" x 4.30" x 0.54"
WPAC-36M	M3427H02	#57 Pedestal seal	5.25" x 6.05" x 0.52"
WPAC-36N	M3427H05	#61 Pedestal seal	4.30" x 5.40" x 0.54"
WPAC-36P	M3427H07	#81 Pedestal seal	2.56" x 3.75" x 0.375"

Seals for Hydraulic Jacks

S.E.E.S. #	O.E.M. #	Jack Size
WPAC-16	691B864H02, 196C145H05	4-1/2"
WPAC-16A	7264C45H05	5"
WPAC-18	691B864H04, 7264C45H07	6"
WPAC-18A	196C145H08	6"
WPAC-19	691B864H05, 7264C45H08	6-1/2"

Bearing Sets

S.E.E.S. #	Description
WBRG-001	Bearing Set, Westinghouse Tail Sheave, Two sets required

Printed Circuit Boards

SE.E.S. #	O.E.M. #	Description
WPC-1	195C503H01	Printed circuit timer, Dual Timer .5 seconds- 2 minutes
WPC-1A	195C502G01	Printed circuit timer, MG shut down, timing 5 minutes
WPC-2	478C315G01, 478C315H02	Wye-Delta timer, 5 minutes
WPC-4	477C843H03, 477C977G03	ERL amplifier
WPC-5	195C252G03	Reverse phase relay
WPC-8	998C092H12	IO8 PCB
WPC-33	998C273H11	MTA PC Board
WPC-34	999C419H11	WC9 PC Board
WPC-14	998C210H24	EBC/ESC Board
WPC-35	998C153H14	MPT PC Board
WPC-30	6996C11H14	Power Supply, 24 VDC
WPC-27	7249C42H06	Power Supply
WPC-28	865A385H01	Power Supply
WPC-20	998C090H12	IO2 PCB Index A
WPC-21	998C091H12	IO6 PCB
WPC-29	2633C12G03	LZD Kit for TTL-DPG
SPC-001	8953050	PCB, door operator Schindler
SPC-002	10003050	PCB, door operator Schindler
SPC-013	221985	PCB, ANN PC board
SPC-014	222519	PCB, IGBT W/ GA board
SPC-015	223200	PCB, CPB/AUXF Joined PC board
SPC-011	387600	PCB, Processor board
SPC-16	223825	PCB, STDC board
SPC-17	590814	PCB, VLNA PCB
SPC-008	225825	PCB, CIO ACD1 PCB
SPC-005	225313	PCB, CHRIPHNA 4 QB PCB
SPC-007	225725	PCB, CHRIPHNA 5 without AC
SPC-006	225515	PCB, SMHC board
SPC-18	224313	PCB, CHRIPHNA 3 without AC
SPC-19	225723	PCB, SMTV PC board
SPC-20	590810	PCB, PEM1.Q ESC PCB
SPC-030	225212	PCB, CIOACD 1.Q Assy
SPC-030A	51523328	PCB, CIOACD 3.Q Assy
SPC-032	225212	PCB, CIOACD 1.Q Assy
WPC-200	1185C43H04	PCB, PE2 PC board
WPC-201	998C225H12	PCB, VEC PC board
WPC-202	998C169H11	PCB, DPR PCB BB
WPC-203	998C238H12	PCB, V2V PC board
WPC-207	998C027H34	PCB, BFS1 PC board
SPC-85	3-4024669	PCB, Model V Amplifier PC board
SPC-201	SY383600	PCB, PF1.Q ESCA ck pcr1 under #sy387600
SPC-202	225094	PCB, SFCB 1.Q (998C148H26)
SPC-203	999C00326	PCB, TRM
SPC-204	590810, 50606954	PCB, PEM 1.Q Assy Escalator Ne Version
SPC-205	225723	PCB, MTV
SPC-206	9986002H14	PCB, PCB, MGI-A
SPC-207	693B110H01	PCB, TTL-DPG Load board
SPC-208	2244766	PCB, CIOHNA 2.Q PCB
SPC-209	590814	PCB, VLNA 2.Q PCB
SPC-210	224313	PCB, CRIPHNA.3 PCB A17 w/o access relay
SPC-211	225445	PCB, CRIPHNA 4.Q PCB (with access relay)
SPC-212	51515513	PCB, Schindler Push Button



WPC-1

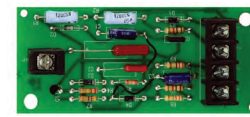

WPC-2



WPC-1A

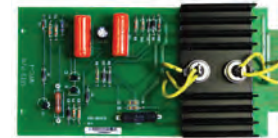

WPC-4

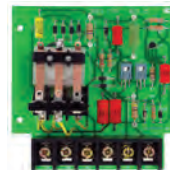

WPC-5

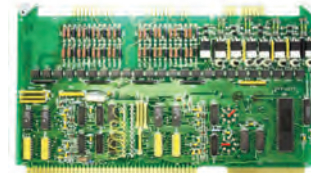

WPC-8



WPC-27



WPC-30

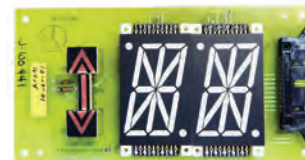

WPC-202



SPC-002



SPC-001



SPC-16



SPC-008



SPC-212



Printed Circuit Boards

TTL

S.E.E.S. #	O.E.M. #	Description
WPC-49	1185C43H04	PCB, PE2 PC Board
WPC-50	1185C32H01	PCB, IT3 PC Board
WPC-51	998C273H11	PCB, MTA PC Board
WPC-52	998C274H11	PCB, MTB PC Board
WPC-54	1185C38H01	PCB, PD4 PC Board
WPC-55	998C039H12	PCB, PD5 PC Board
WPC-56	998C098H37	PCB, PE3 PC Board
WPC-57	998C009H11	PCB, PLO PC Board
WPC-58	998C062H46	PCB, TM1 PC Board
WPC-59	998C063H23	PCB, TM2 PC Board

Q Boards

S.E.E.S. #	O.E.M. #	Description
SPC-021	206748	PCB, Board SIA8, Q
SPC-022	206816	PCB, Board SMTXV2, Q
SPC-023	222821	PCB, LANTHNA 1, Q
SPC-024	222824	PCB, Board Assembly PIHNA, 1, QC (4 per panel)
SPC-025	590098	PCB, RC 3.Q 630V./250V assy
SPC-026	590882	PCB, DSFCR 1.Q VF170/280



SPC-024

World Class

S.E.E.S. #	O.E.M. #	Description
WPC-103	999C401H13	PCB, WCA PC Board
WPC-104	999C414H22	PCB, WC4 PC Board

Epoch I

S.E.E.S. #	O.E.M. #	Description
WPC-60	998C118H11	PCB, ASM PC Board
WPC-61	998C076H14	PCB, DDD PC Board Index A
WPC-62	998C120H11	PCB, DMM PC Board
WPC-63	998C204H12	PCB, DTS PC Board
WPC-64	998C090H12	PCB, IO2 PCB Index A
WPC-65	998C091H12	PCB, IO6 PC Board
WPC-66	998C092H12	PCB, IO8 PC Board
WPC-67	998C102H12	PCB, IOT keysheet Index A
WPC-68	998C002H14	PCB, MGI-A PC Board
WPC-69	998C111H11	PCB, TB1 PC Board
WPC-70	998C113H11	PCB, TB3 PC Board
WPC-11	998C153H15	PCB, MPT keysheet
WPC-19	998C080H15	PCB, MGA keysheet Index A

Epoch 2VA

S.E.E.S. #	O.E.M. #	Description
WPC-71	998C257H11	PCB, PTC PC Board
WPC-72	998C168H24	PCB, TRM Early Version
WPC-74	998C224H11	PCB, ENC PCB
WPC-75	998C255H14	PCB, MGC PC Board
WPC-76	998C254H12	PCB, MGS keysheet Index A ZEHT
WPC-77	998C197H13	PCB, MTV keysheet PC Board
WPC-78	998C256H12	PCB, PTS PC Board
WPC-79	999C003H26	PCB, TRM PC Board
WPC-80	998C149H12	PCB, SPB PC Board
WPC-81	998C169H11	PCB, DPR PCB
WPC-25	998C276H22	PCB, TCP PC Board

Motrol

S.E.E.S. #	O.E.M. #	Description
WPC-82	998C108H12	PCB, ERA PCB Assembly
WPC-83	998C206H12	PCB, ETS PC Board
WPC-84	998C030H27	PCB, MFR Keysheet
WPC-85	998C032H15	PCB, MS1 Keysheet
WPC-86	998C061H14	PCB, MS2 Board
WPC-87	998C127H14	PCB, MS6 PC Board
WPC-88	999C225H25	PCB, MSR PC Board
WPC-89	998C026H26	PCB, MVR Keysheet index A
WPC-90	998C077H24	PCB, PM1 Keysheet index A
WPC-22	998C110H12	PCB, ERB PCB Assembly

300A

S.E.E.S. #	O.E.M. #	Description
WPC-16	998C246H12	PCB, MIO PCB Assembly
WPC-24	998C247H14	PCB, CIO PC Board
WPC-31	998C198H12	PCB, DPI PCB Assembly
WPC-32	998C245H12	PCB, PIB PCB Assembly
WPC-18	998C272H13	PCB, REL PCB Assembly



WPC-16

Printed Circuit Boards

321A

S.E.E.S. #	O.E.M. #	Description
SPC-010	223200	PCB, CPB/AUXF Joined
SPC-027	225313	PCB, CRIPHNA 4.QB PCB without access
SPC-030	225212	PCB, CIOACD 1.Q assy
SPC-003	223956	PCB, CRIPHNA 2.QA assembly
SPC-031	222923 590866	PCB, EBCOM68 assy

330A

S.E.E.S. #	O.E.M. #	Description
SPC-032	225212	PCB, CIOACD 1.Q assy
SPC-038	222837	PCB, HPBHNA2.QA assy
SPC-039	590862	PCB, GCIO360.QE assy
SPC-040	225445	PCB, CRIPHNA 4.Q PCB with access

TXR5

S.E.E.S. #	O.E.M. #	Description
SPC-041	222920	PCB, LONIOH 16 assy
SPC-042	224310	PCB, SETSDL 1.QC assy
SPC-043	222533	PCB, LFTDPI50 assy QB
SPC-044	590862	PCB, GCIO360.QE assy



SPC-038



WPC-93



WPC-94



WPC-10

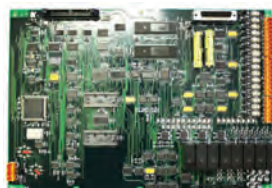

WPC-12

MPH I

S.E.E.S. #	O.E.M. #	Description
WPC-91	998C149H12	PCB, SPB PC Board
WPC-93	998C150H11	PCB, ECB PC Board (Chime Board)
WPC-94	998C146H22	PCB, HRM PC Board
WPC-95	998C202H12	PCB, PHC PC Board
WPC-96	998C164H13	PCB, DPB PC Assembly
WPC-9	998C145H24	PCB, MHP Printed Circuit Board
WPC-10	998C147H15	PCB, DCB Key Sheet Index A
WPC-23	998C173H22	PCB, NSP PCB

MPH II

S.E.E.S. #	O.E.M. #	Description
WPC-97	998C149H12	PCB, SPB PC Board
WPC-100	998C188H11	PCB, IOX PC Board
WPC-101	998C198H12	PCB, DPI PCB Assembly
WPC-12	998C187H26	PCB, MHC PCB Assembly
WPC-15	998C216H28	PCB, RMH PCB Assembly

Miconic A

S.E.E.S. #	SCH/O.E.M. #	Description
WPC-37	998C198H12	PCB, DPI PCB Assembly
SPC-004	224213	PCB, SHVM 1.Q PCB Assembly
WPC-41	998C224H11	PCB, ENC PCB
WPC-17	998C255H14	PCB, MGC PC Board
WPC-42	998C254H12	PCB, MGS Keysheet Index A ZEHNT
WPC-13	998C197H13	PCB, MTV Keysheet PC Board
WPC-43	998C256H12	PCB, PTS PC Board
WPC-26	999C003H26	PCB, TRM PC Board
SPC-012	224310	PCB, SETSDL 1.QC PCB Assembly
WPC-44	998C239H11	PCB, DBC Keysheet
WPC-45	998C227H12	PCB, INT Keysheet
WPC-46	998C228H12	PCB, RDI Keysheet Index A
WPC-47	998C238H12	PCB, V2V PC Board
WPC-48	998C225H12	PCB, VEC PC Board



WPC-15



WPC-37



SPC-004



Miconic VM

S.E.E.S. #	O.E.M. #	Description
SPC-45	3-40290-58	PCB, SSCC PC Board
SPC-46	3-40338-17	PCB, CAMF PC Board
SPC-47	3-40332-63	PCB, EA2232. MA PC Board
SPC-48	3-40332-65	PCB, EK2264. MA PC Board
SPC-49	3-40232-32	PCB, Gearless PAS Board
SPC-50	3-40332-38	PCB, IG500 Pulse Tach PC Board
SPC-51	3-40341-30	PCB, MT1 PB PC Board Assy
SPC-52	3-40340-68	PCB, PAS Geared Board
SPC-53	3-40332-60	PCB, PEC116.MA PC Board
SPC-54	3-40320-63	PCB, RCE Interface PC Board
SPC-55	3-40231-12	PCB, Safety PC Board
SPC-56	3-40342-45	PCB, Safety PC Board
SPC-57	3-40332-61	PCB, SUA116.MA PC Board
SPC-58	3-40337-62	PCB, UVPN 2512.MA PC Board
SPC-59	3-40332-62	PCB, VSR PC Board
SPC-60	3-40352-50	PCB, GAFC-L Gearless
SPC-61	3-40393-54	PCB, I/O PC Board CVT-1011

Miconic V

S.E.E.S. #	O.E.M. #	Description
SPC-62	3-40290-58	PCB, SSCC PC Board
SPC-63	3-40341-26	PCB, GAFC Geared MICONIC V PC Board
SPC-64	3-40340-45	PCB, MPSZ216.MA PC Board
SPC-65	3-40333-48	PCB, PAK216.MA 1092 DISPATCH PCB
SPC-66	3-40338-17	PCB, CAMF PC Board
SPC-67	3-40332-63	PCB, EA2232.MA PC Board, MICONIC V,
SPC-68	3-40332-65	PCB, EK2264.MA PC Board, MICONIC V
SPC-69	3-40232-32	PCB, Gearless PAS Board, MICONIC V,
SPC-70	3-40332-38	PCB, IG500 Pulse TACH PC Board
SPC-71	3-40341-30	PCB, MT1 PB PC Board Assembly
SPC-72	3-40340-68	PCB, PAS Geared Board
SPC-73	3-40332-60	PCB, PEC116.MA PC Board
SPC-74	3-40320-63	PCB, RCE INTERFACE PC Board
SPC-75	3-40332-61	PCB, SUA116.MA PC Board
SPC-76	3-40337-62	PCB, UVPN 2512.MA PC Board
SPC-77	3-40332-62	PCB, VSR PC Board

EVC ELC

S.E.E.S. #	O.E.M. #	Description
SPC-78	3-40220-54	PCB, Emergency Light PC Board & Battery
SPC-79	3-40155-92	PCB, Hi-Voltage Board MDL III/IV
SPC-80	3-40179-99	PCB, Leveling Control Board ELC, IV,
SPC-81	3-40143-00	PCB, Model III Leveling Decoder Board
SPC-82	3-40143-03	PCB, Model III/IV Power Supply
SPC-83	3-40162-07	PCB, Model III/IV Excess Error Board
SPC-84	3-40142-99	PCB, Model III/IV SCR Assembly
SPC-85	3-40246-69	PCB, Model V Amplifier PC Board
SPC-86	3-40143-02	PCB, SCR Trigger Board

Gold Flite

S.E.E.S. #	O.E.M. #	Description
SPC-87	3-40281-07	PCB, GMG Amplifier Board, GMG, Level C
SPC-88	3-40324-87	PCB, Step SW Relay Board
SPC-89	3-40280-18	PCB, Timer Display Board, GDC/GMG/GAC
SPC-90	3-40284-26	PCB, 90V Rev Phase Relay Board
SPC-91	3-40318-72	PCB, GDC Heatsink PC Board Assembly
SPC-92	3-40287-93	PCB, Gaciv Amplifier Board, Dynatro
SPC-93	3-40267-48	PCB, Pattern Board, GDC/GMG, Level F
SPC-94	3-40284-28	PCB, Rev Phase Relay Board, 180V
SPC-95	3-40324-83	PCB, Step Switch Mother Board, 120V
SPC-96	3-40305-20	PCB, Emergency Reset PCB, 24 VDC GDC/GMG/GAM
SPC-97	3-40324-80	PCB, Step Switch Mother Board, 24V
SPC-98	3-40280-14	PCB, Accessory Board, GDC/GMG/GAC
SPC-99	3-40256-98	PCB, G-F Pattern Gen Board (Earthquake)

Accu-Flite

S.E.E.S. #	O.E.M. #	Description
SPC-100	3-40005-27	PCB, Pulse gen board, ACCU/SAM/GAM
SPC-101	3-40006-59	PCB, Accuflite Pos. Interface board
SPC-102	3-40252-30	PCB, Amplifier board, ACCU, level C
SPC-103	3-40305-20	PCB, Emergency Reset PCB 24 VDC, GDC/GM
SPC-104	3-40280-89	PCB, Motor Feild Control Board, SAM/GAM
SPC-105	3-40280-85	PCB, Predictor Board, ACCU/SAM/GAM
SPC-106	3-40890-10	PCB, Amplifier Board, SAM/GAM
SPC-107	3-40277-03	PCB, Memory Board 64FLRS, ACCU/SAM/GA
SPC-108	3-40292-32	PCB, Interface Board, SAM/GAM
SPC-109	3-40231-72	PCB, GFC Board, GAM Level C
SPC-110	3-40292-28	PCB, Data Priority Board, 64FLRS, SAM

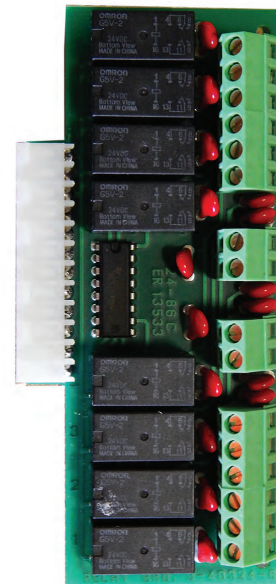

SPC-88

1092-IC

S.E.E.S. #	O.E.M. #	Description
SPC-112	3-4005-27	PCB, Pulse Gen Board, ACCU/SAM/GAM
SPC-113	3-40239-26	PCB, Posin Hall/Call PCB
SPC-114	3-40250-21	PCB, Car Control Board, 1092DRM
SPC-115	3-40012-24	PCB, Output Buff PCB Level B



SPC-96

Tru-Flite

S.E.E.S. #	O.E.M. #	Description
SPC-116	3-40233-09	PCB, Tru-Flite Amp Board, Level B
SPC-117		Power Supply, Miconic PLUS(+/-)-5V, +/-15V 30 AMP
SPC-118		Power Supply, 330A .+5V, +24V, +/-15V 20 AMP
SPC-119	MAP80-4004	Power Supply, Miconic 5, 15, 24V



Resistors



WEC-1A



WEC-1J

Adjustable 10" Resistor 200 Watt

S.E.E.S. #	O.E.M. #	Resistance
WEC-1A	X28AS1H01	.72 Ohms
WEC-1D	X28AS1H29	2.0 Ohms
WEC-1E	X28AS1H02	3.4 Ohms
WEC-1F	X28AS1H30	4.7 Ohms
WEC-1G	X28AS1H03	6.4 Ohms
WEC-1H	X28AS1H04	8.5 Ohms
WEC-1J	X28AS1H05	12.6 Ohms
WEC-1K	X28AS1H06	17.0 Ohms
WEC-1	X28AS1H07	21.5 Ohms
WEC-2	X28AS1H08	25.2 Ohms
WEC-3	X28AS1H09	43 Ohms
WEC-4	X28AS1H10	64.2 Ohms
WEC-5	X28AS1H11	84 Ohms
WEC-6	X28AS1H12	126 Ohms
WEC-7	X28AS1H13	168 Ohms
WEC-8	X28AS1H14	252 Ohms
WEC-9	X28AS1H15	455 Ohms
WEC-9A	X28AS1H16	642 Ohms
WEC-10	X28AS1H17	800 Ohms
WEC-11	X28AS1H18	1000 Ohms
WEC-11A	X28AS1H20	1500 Ohms
WEC-12	X28AS1H21	2000 Ohms
WEC-13	X28AS1H22	2500 Ohms
WEC-13A	X28AS1H23	3000 Ohms
WEC-14	X28AS1H24	4000 Ohms
WEC-14A	X28AS1H25	5000 Ohms
WEC-14B	X28AS1H26	6000 Ohms
WEC-14C	X28AS1H27	8000 Ohms



WEC-9A



WEC-14B

S.E.E.S. #	O.E.M. #	Description
WEC-53	K1918G01	Sliding clip for 1" resistors



WEC-29



WEC-30



WEC-33



WEC-38

Adjustable 5" Resistor 100-160 Watt

S.E.E.S. #	O.E.M. #	Resistance
WEC-29	X28FS1H29	2.0 Ohms
WEC-30	X28FS1H05	12.6 Ohms
WEC-31	X28FS1H06	17 Ohms
WEC-32	X28FS1H07	21.5 Ohms
WEC-33	X28FS1H08	25.2 Ohms
WEC-35	X28FS1H10	64.2 Ohms
WEC-36	X28FS1H11	84 Ohms
WEC-37	X28FS1H12	126 Ohms
WEC-38	X28FS1H13	168 Ohms
WEC-39	X28FS1H14	252 Ohms
WEC-40	X28FS1H15	455 Ohms
WEC-41	X28FS1H16	642 Ohms
WEC-42	X28FS1H17	800 Ohms
WEC-43	X28FS1H18	1000 Ohms
WEC-44	X28FS1H19	1250 Ohms
WEC-45	X28FS1H20	1500 Ohms
WEC-46	X28FS1H21	2000 Ohms
WEC-47	X28FS1H22	2500 Ohms
WEC-48	X28FS1H23	3000 Ohms
WEC-49	X28FS1H24	4000 Ohms
WEC-50	X28FS1H25	5000 Ohms
WEC-51	X28FS1H26	6000 Ohms
WEC-52	X28FS1H27	8000 Ohms



WEC-44



WEC-53



WEC-45

Relays

ES Relays

Contact Count and Configuration

S.E.E.S. #	O.E.M. #	N.O.	N.C.
WR-1	T9560G34	8 Make	
WR-2	T9560G35	7 Make,	1 Break
WR-3	T9560G36	6 Make,	2 Break
WR-4	T9560G37	5 Make,	3 Break
WR-5	T9560G38	4 Make,	4 Break
WR-6	T9560G39	3 Make,	5 Break
WR-7	T9560G40	2 Make,	6 Break
WR-8	T9560G41	1 Make,	7 Break
WR-9	T9560G42	8 Break	

■ Coil sold separately.

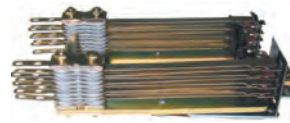

WR-1



WR-4



WR-5



WR-7

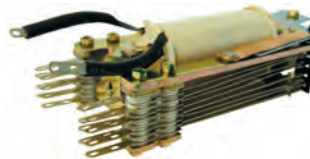

WR-1C



WR-6C

ES Relay & Coil Assemblies

S.E.E.S. #	O.E.M. #	Coil	N.O.	N.C.
WR-1C	324C991G80	125V	8	0
WR-1C2	324C992G80	62.5V	8	0
WR-2C	324C991G71	125V	7	1
WR-2C2	324C992G71	62.5V	7	1
WR-3C	324C991G62	125V	6	2
WR-3C2	324C992G62	62.5V	6	2
WR-4C	324C991G53	125V	5	3
WR-4C2	324C992G53	62.5V	5	3
WR-5C	324C991G44	125V	4	4
WR-5C2	324C992G44	62.5V	4	4
WR-6C	324C991G35	125V	3	5
WR-6C2	324C992G35	62.5V	3	5
WR-7C	324C991G26	125V	2	6
WR-7C2	324C992G26	62.5V	2	6
WR-8C	324C991G17	125V	1	7
WR-8C2	324C992G17	62.5V	1	7
WR-9C	324C991G08	125V	0	8
WR-9C2	324C992G08	62.5V	0	8



WR-10



WR-13



WR-14



WR-21



WR-15



WR-18



WR-17

EST Time Relays

Contact Count and Configuration

S.E.E.S. #	O.E.M. #	N.O.	N.C.
WR-10	H3056G03	2 Make	
WR-11	H3056G04	1 Make	1 Break
WR-12	H3056G05		2 Break

■ Coil sold separately

S.E.E.S. #	O.E.M. #	Description
WR-13	K7305G01	Fingerboard, for EC relay
WR-21		Fingerboard, for EST Relays
WR-14	216B711H04 216B711H01	Contact ladder for ES and EST relays
WR-15	T4483G19	Inductor switch

Mercury-Wetted Relays

S.E.E.S. #	O.E.M. #	Description
WR-16	145A630H01, HGS1230	For Quota Relay Assy.
WR-18	145A630H02, HGS1021	For DM Inductor
WR-18A	145A630H03, HGS1015	For L3V

S.E.E.S. #	West. #	Description
WR-17	324C981G44	EC relay with 125V coil and 4 Make, 4 Break contacts



Relay Components

Relays

S.E.E.S. #	O.E.M. #	Description
SR-200	225733	Relay, CRIPHNA 5. QA Socket with Access Relay
SRP-01	NEA462544	Phase Relay, 3 Phase Monitor, 200-600V



SRP-01



WRP-7

WRP-8



WRP-9



WRP-10



WRP-11



WRP-12

S.E.E.S. #	O.E.M. #	Description
WRP-1	M3466G1	Contact and shunt with silver tip for DS relays, shunt length 6-3/4" x 7/16"
WRP-1A		Contact and shunt without silver tip for DS relays, shunt length 6-3/4" x 7/16"
WRP-2	K180G05 T3534G8	Contact assembly with 6" shunt, copper base 5/8" x 2-1/2"
WRP-3	M1230G04	Contact and shunt assembly, 4-3/4" L with 1/4" dia. silver tip for KS relays
WRP-4	M1230G05	Contact and shunt assembly, 5-1/2" L with 1/4" dia. silver tip for KS relays
WRP-5	M1230G06	Contact and shunt assembly, 6-1/2" L with 1/4" dia. silver tip for KS relays
WRP-6	K4277G01	Movable contact, Heart shaped movable contact for 6B, CR and TC relays
WRP-7	K7310G01	Contact bridge assembly for EC control relay
WRP-8	R7533G04	Brake cooling contact assembly with two silver contacts
WRP-9	630B611G01	Stationary contact for EC control relay, top make or bottom break
WRP-10	630B611G02	Stationary contact for EC control relay, top break or bottom make
WRP-11	M1230G03	Stationary contact for 15A, 30V, KS, V and VR relays, 1-1/8" overall with 1/4" diameter silver tip
WRP-12	M1230G20	Stationary contact for DS relay 7/16" dia. x 1-1/16" tip thread, 13/16" L x 5/32" diameter, 1-1/8" overall

Relay Components



WRP-13



WRP-14

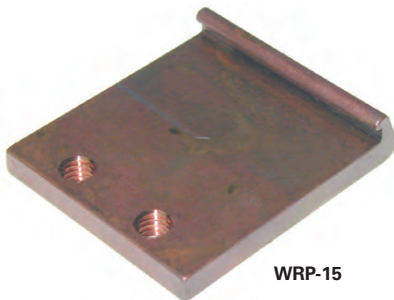

WRP-15

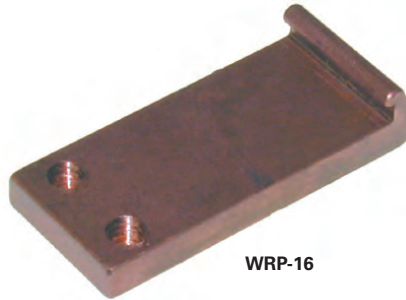

WRP-16



WRP-17

S.E.E.S. #	O.E.M. #	Description
WRP-13	K1809G02	Holder for stationary contact for DS relay
WRP-14	M3467G02	Hex support for stationary contact for DS relay, hex length 1-13/16"
WRP-15	T1139H07	Copper contact, 2 x 2-5/16"
WRP-16	T441H09	Copper contact, 1 x 2-5/16"
WRP-17	P1524H06	Copper contact, 3/4 x 1-3/4" Screw center to center 7/16"
WRP-18	256956	Copper contact, 1-1/8" wide
WRP-19	256922	Copper contact, 3/4" wide
WRP-20	178791	Copper contact, 5/8" wide
WRP-20A	178791-.50	Copper contact, angle, 1/2" wide face



WRP-18



WRP-19



WRP-20



Relay Components



WRP-21



WRP-24

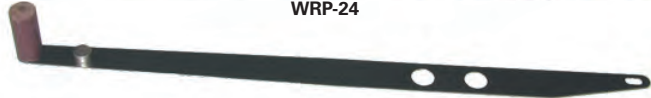

WRP-25



WRP-22A

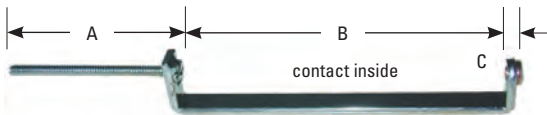

WRP-30, WRP-28



WRP-29, WRP-27



WRP-31



WRP-31A



WRP-35



WRP-33



WRP-34



WRP-35A



WRP-37



WRP-38

Contact Blades for SRL, SR-1 and STL Relays

S.E.E.S. #	Description
WRP-21	Backup support blade, 3-1/8" L without contact
WRP-23	Blade with silver contact and 3/8" phenolic stop
WRP-24	Blade with silver contact, without phenolic stop
WRP-25	Blade with silver tip and phenolic stop on same side
WRP-26	Blade with silver tip and phenolic stop on opposite side
WRP-22A	Spacer, SR, SRL & SN Pile up thin
WRP-22B	Spacer, SR, SRL & SN Pile up medium (.093")
WRP-22C	Spacer, SR, SRL & SN Pile up thick (.125")

Stationary Contacts for 6B, CR and TC Relays

S.E.E.S. #	O.E.M. #	Contact Location	A	B	(Tip) C
WRP-29	X24AS1G01	Outside	2	3-11/16 outside U	1/16
WRP-27	X24AS1G04	Outside	2	2-7/8 inside U	1/16
WRP-30	X24BS1G01	Inside	2	3-3/4 inside U	1/16
WRP-28	X24BS1G02	Inside	2	3-3/32 inside U	1/16

Contact Assemblies for 6B Contactors

S.E.E.S. #	O.E.M. #	Description
WRP-31	M4522G2	Contact with shunt-MAKE
WRP-31A	P-1534-1	Holder & Shunt Assy
WRP-32	M4522G5	Contact with shunt-BREAK
WRP-33	K4278G01	Contact alone-MAKE
WRP-34	K4278G02	Contact alone-BREAK
WRP-35	X22GS1G04	Shunt for 6B contactors, 6-1/8" L
WRP-35A	X22GS1G01	Shunt for 6B contactors, 1-3/4" L

Contacts for SW Interlocks

S.E.E.S. #	O.E.M. #	Length	Description
WRP-37	K3125G02	3"	Finger contact, blade with contact
WRP-38	K3125G03	3-1/2"	Finger contact, blade with contact
WRP-36	K3125G01	3-5/8"	Finger contact, blade with contact
WRP-39	K3125G04	4-3/16"	Finger contact, blade with contact

Relay Components

S.E.E.S. #	O.E.M. #	Description
WRP-40	K181G2, K181G3	Contact assembly for 30VS relay, base 1-1/4" x 1/2" with insulated shunt 7" L
WRP-41	K180 series	Contact assembly , copper base 1/2" x 1-5/8", 2 strand bare copper shunt 4-1/2" L

S.E.E.S. #	O.E.M. #	Description
WRP-42	M4510G1	Base armature for 6B1 contactor
WRP-43	M4523G1	Base armature for 6B2 contactor
WRP-44	M4524G01	Base armature for 6B3 contactor



Tachometer Generator Assembly

S.E.E.S. #	O.E.M. #	Description
WRP-46	569A803H01	Motor , Tachometer generator 30 VDC @ 1800 RPM, 15/16" shaft
WRP-46A	198C030H02	Motor , Tachometer generator 60 VDC
WCB-138	569A803H02	Brush for Tachometer generator
WRP-45	103D556G06	Magnetic coupling for Tachometer
WRP-45A	X49FS1H01	Coupling , flexible, 1/4" to 5/16" coupling
WRP-45B	X49FS1H02	Coupling , flexible, 5/16" diameter
WRP-45M		Magnet , only for WRP-45 (Set of TWO)
WRP-46BA	ACR112-10-10	Coupling , flexible, for WRP-46B
WRP-46BB		Brush Cap , replacement for WRP-46B



S.E.E.S. #	O.E.M. #	Description
WRP-46B	198C030H01	Tachometer , 15 VDC

Starter Contact Kits

S.E.E.S. #	O.E.M. #	Description
WRP-47	373B331G12	Contact kit , size 2, 3 pole
WRP-48	626B187G13	Contact kit , size 3, 3 pole
WRP-49	626B187G17	Contact kit , size 4, 3 pole





Relay Components



WRP-49A



WRP-49B



WRP-52



WRP-53

Hatch & Hoistway Equipment



WRP-50

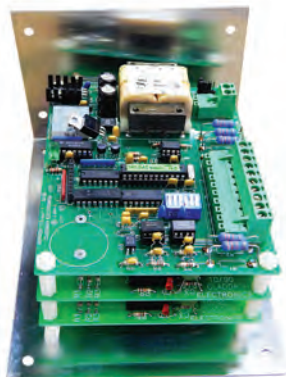

WRP-54B



MIS100K

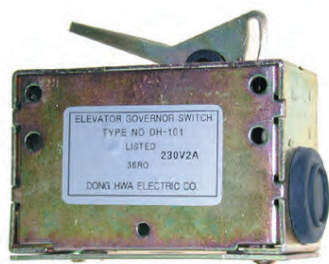

WRP-55

Components for WL Linestarter

S.E.E.S. #	O.E.M. #	Description
WRP-49A	811C985H06	Contact kit, size 2, each kit replaces one pole
WRP-49B	811C985H09	Coil, 208-240V

S.E.E.S. #	O.E.M. #	Description
WRP-52	180C138G02	Auxiliary contact assembly, 2 normally open contacts, for starter
WRP-53	180C138G01	Auxiliary contact assembly, 1 normally open, 1 normally closed contact for L56 interlock

S.E.E.S. #	O.E.M. #	Description
WRP-50	T9165G04	Safety switch, R.H.
WRP-51	T9165G05	Safety switch, L.H.

Stepping Switches

S.E.E.S. #	O.E.M. #	Description
WRP-54B	T9165G08	Stepper, Solid State replacement for old style stepping switch
MIS-100K		Stepper Lube Kit of assorted lubricants, specially formulated for maintaining old style stepping switch wear points. Prolongs life, improves performance.

S.E.E.S. #	O.E.M. #	Description
WRP-55	T9165G08	Bi-Directional Governor Overspeed Switch, Type DH101, 230V2A

Hatch & Hoistway Equipment

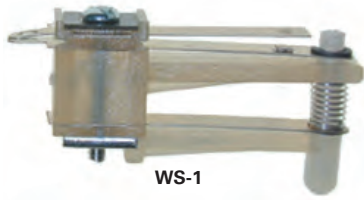

WS-1



WS-3



WS-4

Selector Components

S.E.E.S. #	O.E.M. #	Description
WS-1	217B203G01	Switch, Series selector, 1 make
WS-2	217B203G02	Switch, Series selector, 1 break
WS-3	K3233H01	Rubber coupling for SN selector
WS-4	M1259G03	Brush for type "N" selector
WS-4A		Cam leaf spring replacement for SN selector



WS-4A

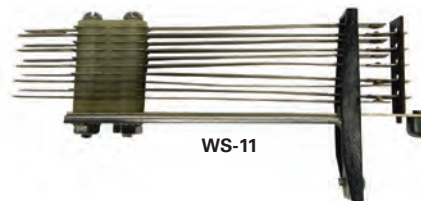

WS-11

Pile-Ups for DM Selector

S.E.E.S. #	O.E.M. #	Description
WS-10	322C830G14	Floor switch, 4 make 1 break
WS-11	322C830G15	Floor switch, 3 make 2 break
WS-12	146A990H01	Nylon cap for DM pile-up

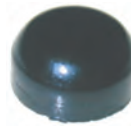

WS-12

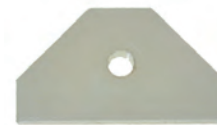

WS-14A

Lead Screw and Nut for SN Selectors

S.E.E.S. #	O.E.M. #	Description
WS-14	M4699H02	Traveling nut for selector
WS-14A	569A223H01	Nylon cap for SN selector
WS-15	X18BS1H02	Bearing for SN selector screw
WS-17	M4700G06	Lead screw and nut, 9-15 Floor maximum, 18-5/16" L
WS-17A	M4700G05	Lead screw assy, 8 Floor maximum, 11-5/16" L
WS-17B	M4700G07	Lead screw assy, 16-24 Floor maximum, 27-5/16" L



WS-14



WS-15



WS-17A



Hatch & Hoistway Equipment

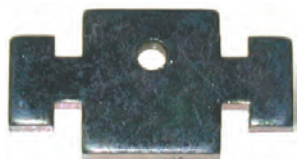

WS-6

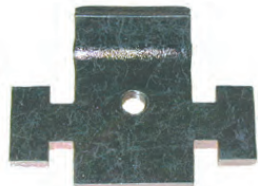

WS-7



SLS-1



SLS-2



WE-2

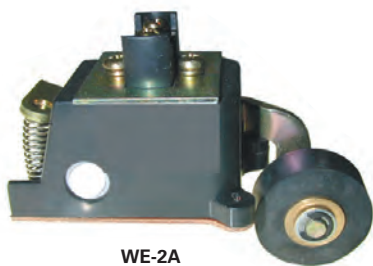

WE-2A



WS-5A



WS-5AB

S.E.E.S. #	O.E.M. #	Description
WS-5A		Nylon tape guide, with holes
WS-5AB		Tape Guide, heavy duty brass, for IP8300
WS-5A-INSERT		Insert for Tape Guide
WS-6	145A111H01	Tape Guide, Short Clip, for WS-5/5A
WS-7	145A111H02	Long clip, with radius bend
GS-3	GALX-0307N	Tape Guide, for GAL Selector

Limit Switches

SEES#	O.E.M. #	Description
SLS-1	418482	Latching Reed Switch, Leveling Used On Schindler KE8 Lev Assy
SLS-2	1319B05H01	Magnetic Reed, Switch Assy
SLS-3		Latching Reed Switch, Leveling Used On Schindler KE8 Lev Assy
SLS-4	KE8-U	Schindler Limit Switch Kit, 8 Switch Unit
SLS-4A	3-40022-15	Schindler Limit Switch Mounting Square Nut for KE8 and KE14
SLS-5	KE14-U	Schindler Limit Switch Kit, 14 Switch Unit
SLS-6		Schindler Leveling Sensor 3 Lane Sensor
WE-2	321C201G01	Hatch limit switch, normally closed
WE-2A	321C201G02	Inching switch, N.O.

Type E Landing Switch

S.E.E.S. #	O.E.M. #	Description
WS-8A	324C969G04	Switch, 1 make 1 break
WS-8B	324C969G03	Switch, 2 make
WS-8C	324C969G07	Switch, 1 break
WS-8D	324C969G06	Switch, 1 make
WS-8E	324C969G05, 324C969G08	Switch, 2 break

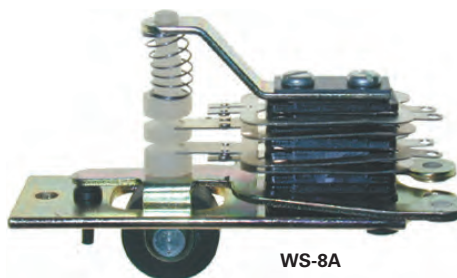

WS-8A

Hatch & Hoistway Equipment

S.E.E.S. #	O.E.M. #	Description
WS-16	145A742G01	Advancer take-up roller
WS-16A	145A741G01	Advancer take-up roller
WS-18	216B311G02	Cam, 5-1/2" w/ hardware
WS-19	216B311G03	Cam, 8" with hardware
WS-20	216B311G04	Cam, 19" with hardware
WS-21	216B311G01	Cam, 3" with hardware
WS-22	5061A04H02	Beam switch, leveling



WS-16



WS-16A



WS-21



WS-18



WS-20



WS-22

S.E.E.S. #	O.E.M. #	Description
SCSW-1		Switch, Security Windows
SCSW-2		Switch, for Landing Door
SCSW-3	332969	Switch, UKT Automatic Reset
SCSW-4	292798	Switch, UKS



SCSW-1



SCSW-2



SCSW-3



SCSW-4

TRACTION MOD GOT YOU TIED DOWN?

THE ELECTRONIC UPGRADE FOR OLD-STYLE MECHANICAL SWITCHES

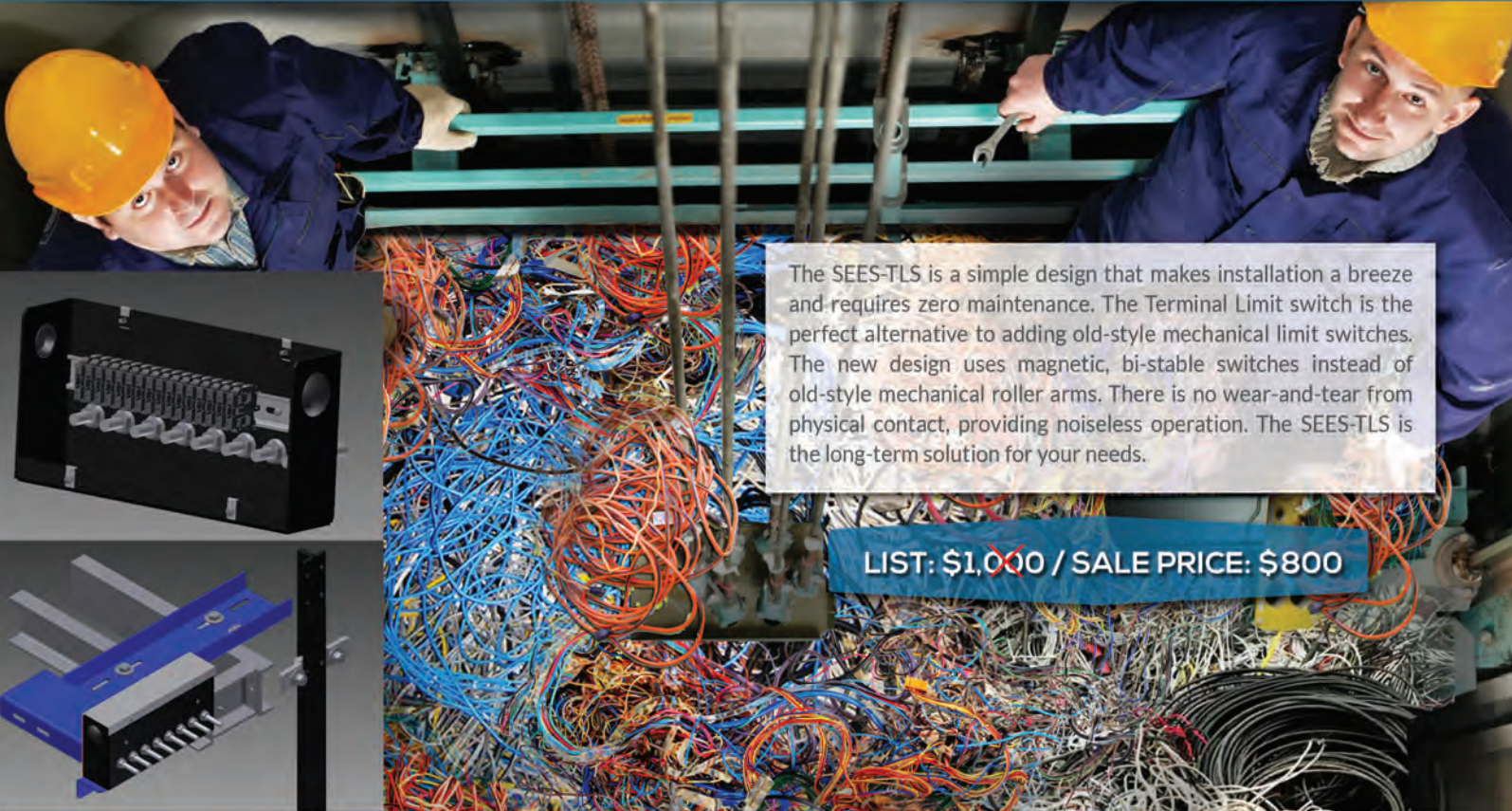

The SEES-TLS is a simple design that makes installation a breeze and requires zero maintenance. The Terminal Limit switch is the perfect alternative to adding old-style mechanical limit switches. The new design uses magnetic, bi-stable switches instead of old-style mechanical roller arms. There is no wear-and-tear from physical contact, providing noiseless operation. The SEES-TLS is the long-term solution for your needs.

LIST: \$1,000 / SALE PRICE: \$800

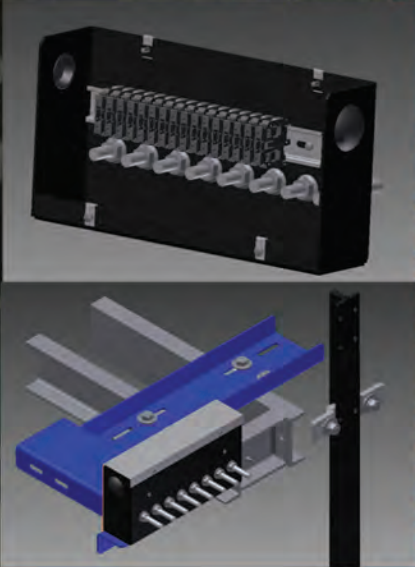

HOW IT WORKS

The switch assembly is mounted to the car top using our universal brackets system. The magnetic switches are arranged so that they interact with rail-mounted magnets in the hoistway, providing the two-way signal for the controller.

MAINTENANCE FREE

The SEES Terminal Limit Switches are tested, dependable, and have no moving parts, making them virtually maintenance-free and ultimately reducing call-backs.

EASY TO INSTALL

- Easy installation using universal bracket system
- Eliminates the need for hoistway wiring
- No adjustments after initial installation
- Reduced Installation cost
- No moving parts

Installation is a breeze and no maintenance is required!

FREE WITH PURCHASE OF SEES-TLS!



GET BOTH FREE WITH THE PURCHASE OF A SEES-TLS!!
A \$55.00 VALUE

SEES-JUMPER-001
SEES-TOOL-002

MANY USES

- Perfect for modernization projects
- Terminal slowdown
- Access limit switch
- Speed limiting
- Emergency terminal stopping

ADVANTAGES

- Easy to follow instructions
- Non-contact, noiseless operation
- Durable and accurate magnetic switching
- Best value and low cost installation

By Phone:
800.526.0026
954.971.1115

By Fax:
954.917.7337
Visit Us: www.SEESinc.com



Always Smooth Sailing

Transformers

S.E.E.S. #	O.E.M. #	Description
WTR-2	325C827H02	Transformer, 300VA, PV: 230/460
WTR-3	320C940H02	Transformer, 550VA, PV: 400, SV: 101 taps
WTR-4	630B480H01	Pulse transformer
WTR-5	692B253H01	Transformer, 600VA, PV: 208/230/460, SV: 115/230
WTR-6	144A212H01	Transformer, 5VA, PV: 110/115, SV: 15V
WTR-7	320C940H01	Transformer, 550VA, PV: 200/260, SV: 101V
STR-001	5058A18H01	Transformer, 350 VA P = 230/460, S = 115/160
STR-002	198C033H01	Transformer, 550 VA, P = 230/460, S = 115/160



WTR-2



WTR-3



WTR-4



WTR-5



WTR-6



WTR-7



STR-001

Wheels

Type B3M Hanger Assemblies

S.E.E.S. #	O.E.M. #	Description
WW-1	T5411G99	Hanger assembly, 3-3/8" O.D., complete for flat track
WW-1R	T5411G99-Round	Hanger assembly for Round Track 3-3/8", Individual
WW-2	R8858G01	Hanger roller, 3-3/8" diameter, aluminum with polyurethane tire
WW-1A	R8858G01	Hanger assembly, Less Roller, requires WW-2 roller
WW-10	152B011G02	Steel upthrust roller for above, 31/32" diameter x 7/16" wide



WW-1



WW-1R



Wheels

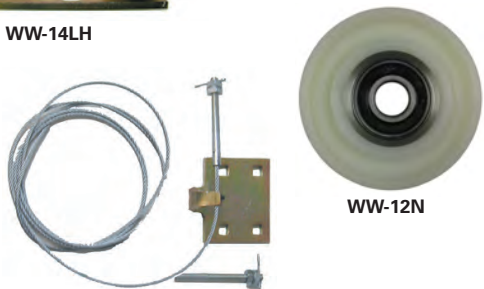
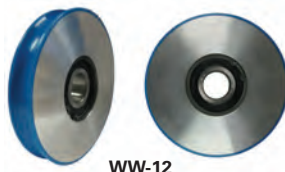
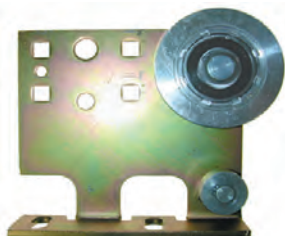
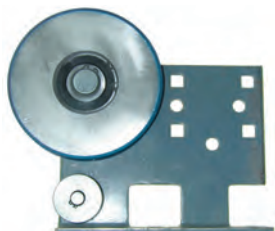
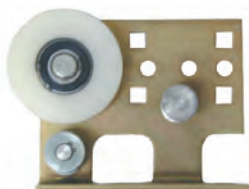
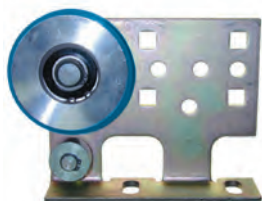
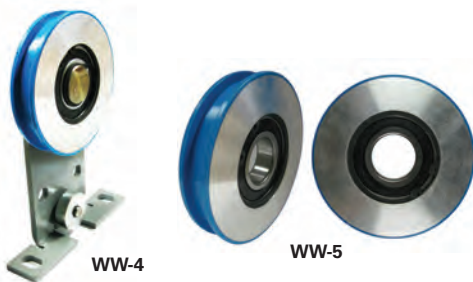

Type A3M Hanger Assemblies

S.E.E.S. #	O.E.M. #	Description
WW-4	T5409G99	Hanger assembly complete
WW-5	R8636G98 R8636G01	Hanger roller , 4-3/8" diameter, 1-1/8" bearing, aluminum with polyurethane tire, fits square rail
WW-6	M6029G01	Steel upthrust roller for above 1-3/8" diameter x 7/16" wide

Type ACD/ACN Hanger Assemblies

S.E.E.S. #	O.E.M. #	Description
WW-7RH	M7405G99	Hanger assembly complete, R.H. with WW-18
WW-7LH	M7405G99	Hanger assembly complete, L.H. with WW-18
WW-7RH-NYLON	M7405G3, G5	Hanger assembly complete, R.H. with WW-17 nylon roller
WW-7LH-NYLON	M7405G4, G6	Hanger assembly complete, L.H. with WW-17 nylon roller
WW-17	576B535G04	Hanger roller 2-3/4" diameter, nylon roller
WW-17A		Roller , Nylon 2-3/4" O.D. x.6693" bore, 6203 bearing
WW-18	576B535G98	Hanger roller 2-3/4" diameter, aluminum with polyurethane tire
WW-10	152B011G02	Steel upthrust roller for above 31/32" diameter x 7/16" wide

Type AC2 Hanger Assemblies

S.E.E.S. #	O.E.M. #	Description
WW-11RH	324C083G99	Hanger assembly complete, R.H.
WW-11LH	324C083G99	Hanger assembly complete, L.H.
WW-6	M6029G01	Steel upthrust roller for above 1-3/8" diameter x 7/16" wide
WW-14LH-P	W408L-POLY	Hanger assembly L.H. with Poly Roller
WW-14RH-P	W408R-POLY	Hanger assembly R.H. with Poly Roller
WW-14LH-PR	W408L-POLY-RH	Hanger assembly L.H. with Poly Roller, Reversed (Backside)
WW-14RH-PR	W408R-POLY-RH	Hanger assembly R.H. with Poly Roller, Reversed (Backside)
WW-12	323C235G02	Hanger roller , 4-1/4" diameter, 6204" bearing .7874" I.D., aluminum with polyurethane tire
WW-12N	323C235G01	Roller , Nylon 4-1/4" O.D. with .7874" I.D.
WDO-60F	144A883G01	Cable Assembly includes WDO-60D and E

Wheels

Type ACA Hanger Assembly E4 Entrances

S.E.E.S. #	O.E.M. #	Description
WDO-60G	682A139H02	Door Roller Stud, 1.360AL, 1/2-20 thread
WDO-60I	569A700H01	Cinch Nut, 1/2-20 Shoulder for Hanger Roller
WHDW-001	569A753H01	Spacer Washer, for Hanger Roller
WW-14RH	325C798G01	Hanger assembly complete, R.H.
WW-14LH	325C798G02	Hanger assembly complete, L.H.
WW-14S		Stud Mounting for Hanger Bracket, Requires Peening in Place
WW-14S-N		Nut for WW-14S, 1/2-20 Wedge Nut
WW-15	325C798G09	Aluminum roller, 2-3/4" diameter
WW-15A		Aluminum roller, 2-3/4" diameter .600" thick
WW-15P	W-408W1-POLY	Hanger roller, Alum w/ Poly 2-3/4" O.D. for WW-14LH/RH-P
WW-16	325C798G10	Upthrust roller for above 1.00" dia x 7/16" wide



WDO-60G



WDO-60I

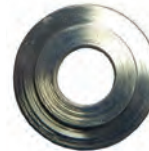

WHDW-001



WW-14S-N



WW-15P



WW-15

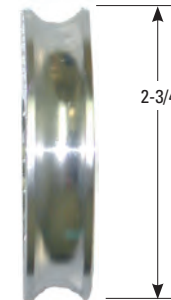

WW-15A

Hanger Assemblies

S.E.E.S. #	Description
SCHR-2A	Hanger assembly, 1.57" x .35", 40mm x 9mm Straight Bracket only
SCHR-2B	Hanger assembly, 1.57" x .35", 40mm x 9mm Straight Bracket with Hardware
SCHR-3A	Hanger assembly, 1.57" x .35", 40mm x 9mm Offset Bracket
SCHR-3B	Hanger assembly, 1.57" x .35", 40mm x 9mm Offset Bracket, with Counter Sunk Holes

Track Liner

S.E.E.S. #	O.E.M. #	Description
WDO-65	569A844H01	Nylon track liner, sold in 12 ft. length or cut to your specifications
WDO-65A	569A844H0110	Nylon track liner, sold in 10 ft. length
WDO-65B	569A844H01-8	Nylon track liner, sold in 8 ft. length
WDO-65B-SS		Track liner, stainless steel, 99" Long with hardware
WDO-65C		Track Liner, 6' sections
WDO-65C-SS		Track Liner, stainless steel, 74" Long with hardware
WDO-65D-SS		Track Liner, S/S, 92" Long w/ Hardware
WDO-65-SPECIAL		Track Liner, (specify length)

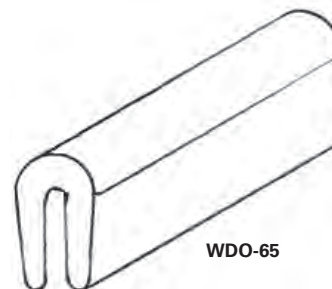

WDO-65



Wheels

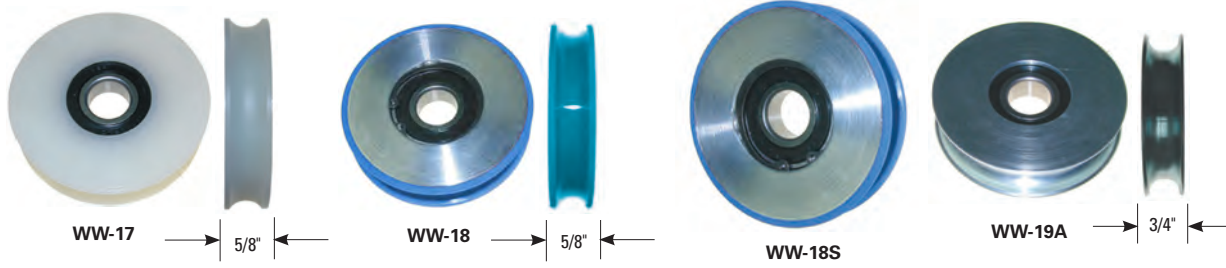

S.E.E.S. #	O.E.M. #	Description
WW-17	576B535G04	Nylon roller, 2-3/4" dia., .5906" I.D.
WW-18	576B535G98	Aluminum roller with polyurethane tire, 2-3/4" dia., .5906" I.D.
WW-18S	576B535-G98	Hanger Roller, 2-3/4" Steel with poly, .5906" I.D.
WW-19A	7266C866G01	Steel hanger roller, 3" dia.
WW-20	144A277G01	Roller guide wheel, 3" dia., .6693" I.D., 1" thick
WW-20A	144A277G02	Roller guide wheel, 3" .6693 bore, steel hub
WW-20AA	144A28H01	Bushing, Side bushing for 3" Roller Guide (465D274G02)
WW-20AH		Roller guide wheel, 3" .6693 bore, steel hub, hard poly
WW-20BB	144A28H02	Bushing, Face bushing for 3" Roller Guide, assembly WRG-005 (465D274G02)
WW-20-S		Post Shaft for WW-20 roller
WW-20-SS		Shaft, for side roller on WRG-005/6
WW-21	323C160G01 323C160G02	Roller guide wheel, 6" dia., tire face 13/16", .6693", I.D., double bearing
WW-21A	M5594G02	Roller guide wheel, 4-1/2" O.D., 1-1/4" thick with polyurethane tire, tire face 13/16", bearing .6693" I.D., double bearing
WW-21B	M5594G04 M5594G05 M5594G01	Roller guide wheel, 3-1/2" dia. with polyurethane tire, tire face 5/8", bearing .6693" I.D., double bearing
WW-21AH	M5594G02	Roller Guide wheel, 4-1/2" O.D. x 1-1/4" W .6693 I.D., HD 90 Duro
WW-23	M5594G03	Roller guide wheel, 10-1/4" dia., .6693" I.D.
WHDW-001		Spacer Washer, for Hanger Roller

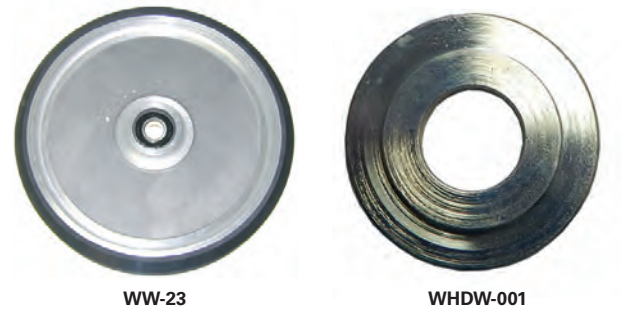

S.E.E.S. #	O.E.M. #	Description
SCGS-2		Guide Shoe Insert, for Counter Weight 150mm x 30 mm x 10mm
SCGS-3		Guide Shoe, for L10 Counter Weight
SCGS-4		Guide Shoe Insert, for 300P 101mm x 10mm Rail
SCGS-5		Guide Shoe Insert, for 300P 101mm x16mm Rail
SCGS-6		Guide Shoe Insert, for Counter Weight 150mm x 30mm x 16mm
SCGS-10		Guide Shoe, for L7
SCGS-11		Guide Shoe Insert, for T22 220mm x 10/16mm
SCGS-12		Guide Shoe, for Counter Weight, 16mm Rail
SCGS-13		Guide Shoe Head, for Counter Weight
SCGS-14		Polyurethane Sliding Rail
SCGS-18	693B180H01 7029C76H01	Guide Shoe Insert, Side For Assy
SCGS-19	693B476H02	Guide Shoe Insert, 330A Nylon
SCGS-23		Polyurethane Sliding Rail



SCGS-2



SCGS-3



SCGS-4



SCGS-5



SCGS-6



SCGS-10



SCGS-11



SCGS-12



SCGS-13



SCGS-19



Wheels



WRG-001



WRG-001A



WRG-002

S.E.E.S. #	O.E.M. #	Description
WRG-001	627D989G08	Roller Guide Assembly, 6" roller 8-16# car rail
WRG-001A		Adaptor Plate, WRG-001 to URG-002 (Also WRG-004)
WRG-002	465D274G01	Roller Guide Assembly, 3" roller 8-16# CWT Rail
WRG-003	627D989G03	Roller Guide Assembly, 4.5" + 6" roller 8-16# CWT Rail
WRG-004	627D989G05	Roller Guide Assembly, 6" roller 16# CWT Rail
WRG-005	465D274G02	Roller Guide Assembly, 3" roller 8-16# Car Rail
WRG-006	465D274G03	Roller Guide Assembly, 3" roller replacement
WRG-007	627D989G04	Roller Guide Assembly, 4.5" & 6" Roller, 18.5# CWT Rail
WW-20BB		Bushing, face bushing for 3" roller guide (465D274G02)
WW-20-SS		Shaft, for side roller on WRG-005/6



WRG-003



WRG-005



WRG-004



WRG-006

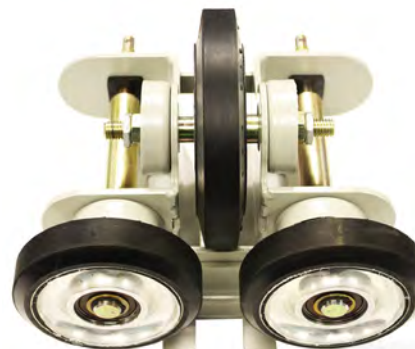

WRG-007

Rollers

S.E.E.S. #	O.E.M. #	Description
WW-24	151B452G01	Terminal Motion (T.M.) Roller Assembly Kit , 4" O.D., 13/16" wide, bearing .6693" I.D.
WW-24A		Roller , 4" O.D., alone for WW-24
WW-24-XHDW-KIT		Hardware Kit , for WW-24
WW-25	M1821G01	Roller , alone for Type "S" Limit Switch
MW-8	694B995H01	Door Roller , 3.7" O.D., 1.573" I.D., 3-11/16" bearing
WW-28	694B995H01	Roller , For EZ-Oper 3-1/4" O.D. with stud
WW-21C	K5212H05	Face Bushing , polyurethane, 2-1/4" O.D., .875" I.D. for shaft WW-21F, .600" W. One per assembly
WW-21C-A	K5212-2	Face Bushing , for roller guide 2-1/4" O.D., 13/16" I.D. x 1" Thick
WW-21D	144A237H02	Side Bushing , polyurethane, 2-1/4" O.D., 1/2" I.D. for shaft WW-21G .625" W. Two per assembly
WW-21D-A	144A237H01	Side Bushing , for roller guide 2-1/4" O.D., 1/2" I.D. x 1" Thick
WW-21E	144A233H01	Rubber washer , for roller guide wheel assembly
WW-21F	146A988H01	Shaft , only, for face roller WW-21, WW-21A, and WW-21B roller guide wheel assemblies
WW-21G	576B701H01	Shaft , only, for side roller WW-21, WW-21A, and WW-21B roller guide wheel assemblies
WW-21H	144A237H03	Bushing Assembly , Side post with urethane bumper
WHDW-001	569A753H01	Washer , Shoulder Spacer, used on hanger roller



WW-24



WW-21C

WW-21C-A



WW-21D

WW-21D-A

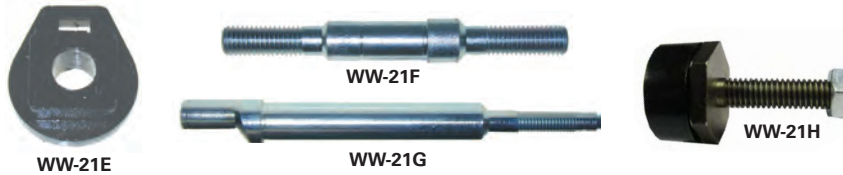

WW-21E

WW-21F

WW-21H

WW-21G



SCDV-3



SCGS-15

S.E.E.S. #	Description
SCDV-3	Roller , for Door Lock 26mm x 14mm ID:9
SCGS-15	Roller , for Guide Shoe 150mm x 30mm x 2mm, bearing 6201 ID:12
SCGS-16	Roller , for Guide Shoe 100mm x 25mm, bearing 6205 ID:25
SCGS-17	Guide Shoe Insert , Face For The Square Tube Rail
SCHR-1	Roller , for Hanger, O.D. 76mm
SCHR-2	Roller , for Hanger, 75mm x 12mm, straight panel
SCHR-3	Roller , for Hanger, 75mm x 12mm
SCHR-7	Roller , for Hanger 54mm x 18mm GD:48, bearing 6200 ID:10
SCHR-8	Roller , for Hanger for AD9 72mm x 15mm GD:64, bearing 6200
SCHR-9	Roller , Retaining for Hanger for 300P 34mm x 19mm GD:28
SCHR-11	Roller , for Hanger 54mm x 20mm GD:48, bearing 6200 ID:10
SCHR-051	Upthrust , Eccentric w/ 6203Brg 5/8-18 Thrd
SCLO-2	Roller , for Door Lock 31mm x 21mm ID:14
SCLO-3	Roller , for V30 Door Lock 30mm x 15mm ID:12
SCLO-14	Roller , for Door Lock 31mm x 21mm ID:12
SCWH-17	Roller Assembly , sheave support plate
SCWH-19	Guide Roller
SCWH-20	Roller , 76mm x 25mm, 6204
SCWH-20B	Anti-Static Roller , 98mm x 30mm



SCHR-7



SCHR-8



SCHR-1



SCHR-2



SCHR-3

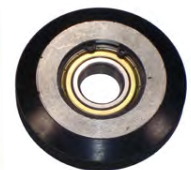

SCGS-16



SCHR-11



SCLO-2



SCLO-3



SCWH-17



SCWH-20

Ohms Law Pie Chart

This "Ohms Pie Chart" is a wonderful tool in determining what formula to use during calculations for the various components of a circuit.

Example:

To find power in watts, place your finger over the P and reference the formula, I R. So $P=I R$.

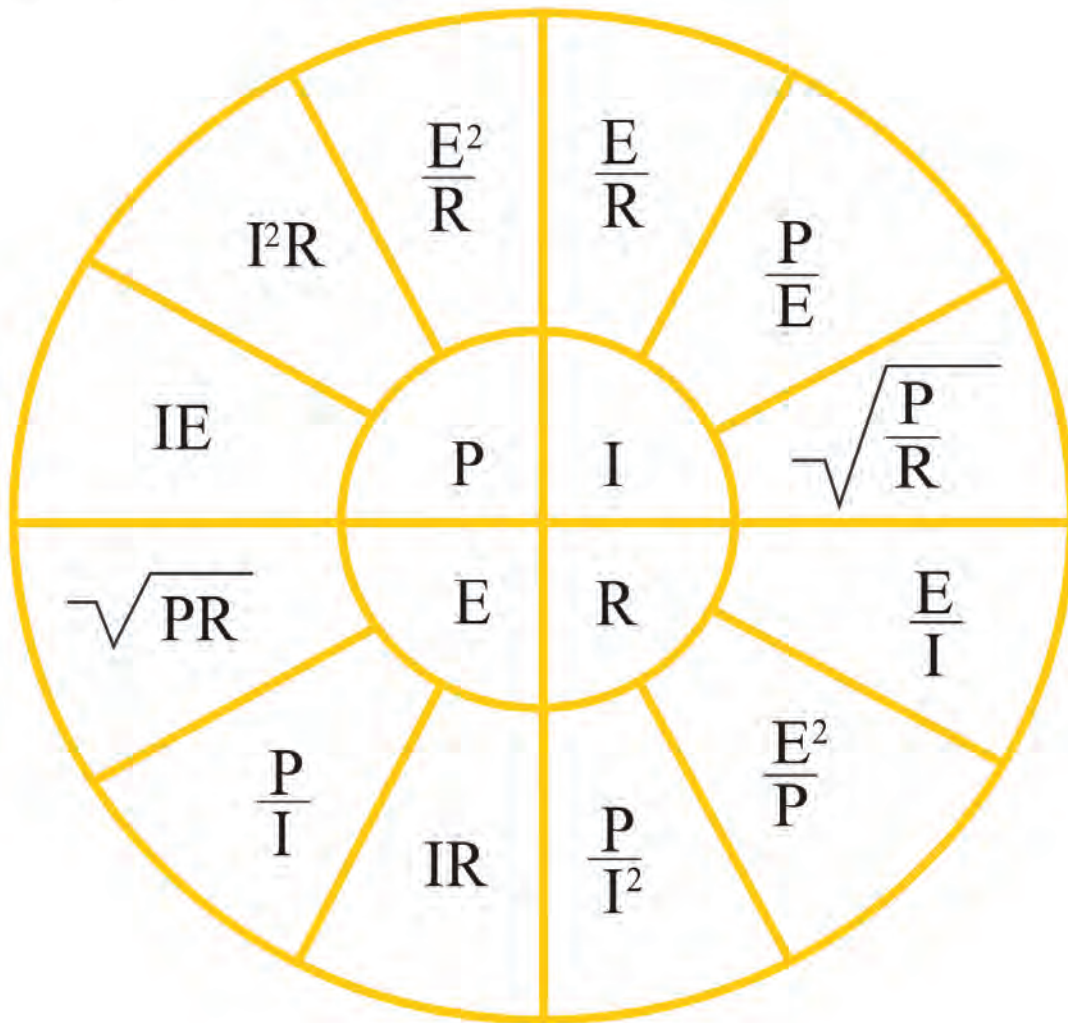

In order to determine the third component you must know two of the components. The above chart is for DC power; for AC power the power factor PF must be included.

Courtesy of ELEVATOR WORLD, INC., from Elevator Maintenance Manual. Copyright © 1999. Reprinted by permission.

THYSSENKRUPP

QUICK LOCATOR GUIDE

- Car Signal Components** 864-869
 - Contacts 865-866
 - Key Switches and Keys 868-869
 - Pushbutton Accessories 866-867
 - Pushbutton Assemblies 864
- Door Parts and Equipment** 870-872
 - Cam, Pick-up Kit 871-872
 - Clutch and Restrictors 871-872
 - Door Motors 870
- Machine Parts** 874
 - Encoder 874
 - Seals 874
- Motors** 870
- Printed Circuit Boards** 873
- Relays** 874
- Wheels and Rollers** 874
 - Counterweight Roller 874
 - Door Lock Roller 874
 - Hanger Rollers 874

Car Signal Components

Pushbutton Assemblies

S.E.E.S. #	O.E.M. #	Description
TPB-001	9991177	Button , Arrow, TACH20, Red LED
TPB-002	9835641	Pushbutton , 24V Vandal Resistant, Red LED illuminated
TPB-006	9991104	Pushbutton , Assembly Black "Close Door"
TPB-007	9991190	Pushbutton , Assembly Black "Open Door"
TPB-008		Pushbutton , Assembly Black, "HELP" Red LED
TPB-215	9836245	Pushbutton , Fire Hat Assembly IT
TPB-218		Pushbutton , Vandal Proof Multi Volt, White LED, California Style
SEES-PB-30M-CC-W		Pushbutton , stainless steel, Brush Dome Vandal with White Center "Call Cancel" Multi-Volt 24-120V
SEES-PB-30M-MOW-R		Pushbutton , stainless steel, brushed, flat, vandal resistant with red dot, Mowery Retrokit, Multi-Volt 24-120V
SEES-PB-30M-B		Pushbutton , stainless steel, brushed, flat, vandal resistant w/ blue center & halo, multi-volt, 24-120V
SEES-PB-30M-R		Pushbutton , stainless steel, brushed, flat, vandal resistant w/ red center & halo, multi-volt, 24-120V
SEES-PB-30M-W		Pushbutton , stainless steel, brushed, flat, vandal resistant w/ white center & halo, multi-volt, 24-120V



TPB-001



TPB-002



TPB-006



TPB-007



TPB-008



TPB-215



SEES-PB-30M-CC-W



SEES-PB-30M-W



TPB-218



SEES-PB-30M-R

New Style Contact Blocks

S.E.E.S. #	O.E.M. #	Description
TPB-003	9991165	Pushbutton , Black, Blank
TPB-004	9846352	Contact , for Push Button, Red
TPB-004A		Contact , Push Button, Red LED 12-120V multi-volt
SEES-PB-MVCB-B		Contact Block , Multi-Volt Blue 3 LED, 24-120 VAC/DC
SEES-PB-MVCB-G		Contact Block , Multi-Volt Green 3 LED, 24-120 VAC/DC
SEES-PB-MVCB-R		Contact Block , Multi-Volt Red 3 LED, 24-120 VAC/DC
SEES-PB-MVCB-W		Contact Block , Multi-Volt White 3 LED, 24-120 VAC/DC
SEES-PB-MVCB-SL-W		Contact Block , Multi-Volt White 1 LED, 6-120 VAC/DC
TPB-010	9739555	Switch Button-IT
TPB-201	9854228	Contact , for 24V Red 4 Pin Pushbutton
TPB-202	9858265	Contact , for 24V White 4 Pin Pushbutton
TPB-205	9724635	Contact , Illuminates White Terminal Pushbutton
TPB-205A		Contact , Push Button LED White, 24-120V multi-volt
TPB-207	9854218	Contact , for Pushbutton, non-illuminating, 4 Pin
TPB-210	9738988	Contact , for Pushbutton, Blue LED, Aurora, 120V
TPB-212	9895298	Contact , with 4 Pin Connector, Blue Illuminated, 24V



TPB-003



TPB-004



TPB-004A



TPB-010



SEES-PB-MVCB-B



SEES-PB-MVCB-W



TPB-201



SEES-PB-MVCB-R

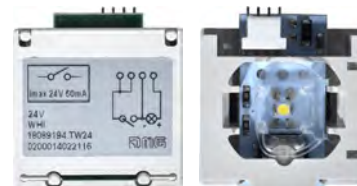

TPB-202



TPB-205

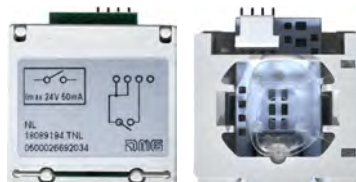

TPB-207

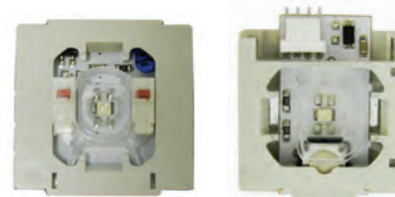

TPB-210

TPB-212

Car Signal Components

New Style Pushbuttons

S.E.E.S. #	O.E.M. #	Description
TPB-200	9739490	Button , Blank Stainless for Vandal Resistant
TPB-200CC	9739490-CC	Button , Blank Stainless for Vandal Resistant
TPB-204	9821456	Button , "Blank" Car Pushbutton Black with Gray Bezel
TPB-208	9787874	Button , Arrow Hall
TPB-209	9823698	Button , Blank for Car
TPB-213	9872314	Button , Vandal Resistant California V10
TPB-214	9739580	Button , Arrow Hall California Style



TPB-200



TPB-200CC



TPB-204



TPB-208



TPB-209



TPB-213



TPB-214 FRONT



TPB-214 BACK



TPB-211 FRONT



TPB-211 BACK



TPB-RING



TPB-203



TPB-216



TPB-217



TPB-219



TPB-220

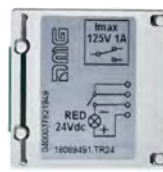

TPB-005



TPB-206



Old Style Contact Blocks

S.E.E.S. #	O.E.M. #	Description
TPB-005	9739567	Contact block , for 4 pin Push Button, Red illumination, 24V
TPB-206	9738496	Contact , for Pushbutton, 12-24V, Red

Old Style Pushbuttons

S.E.E.S. #	O.E.M. #	Description
TPB-211	9765652, 680AR1	Button , Blank Car Pushbutton

Pushbutton Accessories

S.E.E.S. #	O.E.M. #	Description
TPB-RING		Vandal Ring , metal, for TPB Series
TPB-203	590814	Bezel , Grey for TPB Buttons
TPB-216	9875207	Jewel , Thin Fire Hat
TPB-216A	9730412	Jewel , Thin "Medical Emergency"
TPB-216B	9875207KIT	Jewel , Thin Fire Hat Assembly, Ring and Wires
TPB-216C	9730412	Jewel , Thin "Elevator Emergency Power"
TPB-217	9835015	Card , Fire Hat LED with 1 LED
TPB-218-SPECIAL		Push Button , Vandal Proof, Laser marked
TPB-219	9817669	Push Button , Vandal Resist, 4S 24V, Red LED
TPB-220	9721630	Pushbutton , "Help" Black Head Only
TPB-221	9728385	Pushbutton , "Hold Door" White Head Only
TPB-222	9728544	Pushbutton , "Open Door" White Head Only
TPB-223	9777770	Pushbutton , "Help" Black Head Only

Pushbutton Accessories

S.E.E.S. #	O.E.M. #	Description
TPB-224	9821345	Pushbutton , "Door Hold" Black Head Only, Microban Impregnated
TPB-225	9835275	Pushbutton , "Open Door" Black Head Only
TPB-226	9873548	Pushbutton , "Open Door" White Head Only
TPB-227	9723171	Pushbutton , "Call Cancel" White Head Only
TPB-228	9723195	Pushbutton , "Open Door Front" Black Head Only
TPB-229	9723687	Pushbutton , "Close Door Rear" Black Head Only
TPB-230	9723778	Pushbutton , "Open" Black Head Only
TPB-231	9735446	Pushbutton , "Call Cancel" Black Head Only
TPB-232	9728394	Pushbutton , "Close Door" Black Head Only, Microban Impregnated
TPB-233	9736547	Pushbutton , "Door Open" White Head Only
TPB-234	9723158	Pushbutton , "Close Door Front" White Head Only
TPB-235	9723183	Pushbutton , "Close" Black Head Only
TPB-236	9723274	Pushbutton , "Close Door Front" Black Head Only
TPB-237	9723675	Pushbutton , Pushbutton, "Open Door Rear" Black Head Only
TPB-238	9723766	Pushbutton , "Phone" Black Head Only
TPB-239	9723791	Pushbutton , Pushbutton, "Close Door Rear" Black Head Only
TPB-240	9748524	Pushbutton , "Arrow" White, Hall Head Only, Microban Impregnated
TPB-241	9867211	Bezel , ADA Help / Phone
TPB-242	9722117	Pushbutton , Vandal Resistant Illuminated SS4 VR DPDT, (Lamp & Socket not included)
TPB-243	9836214	Bezel , Isis Button
TPB-244	9726962	Pushbutton , "Open Door Front" Black Head Only



TPB-226



TPB-235



TPB-241



TPB-243

Car Signal Components

S.E.E.S. #	Description
US-B50-CAR	Replacement Push Button , complete US car Soft Touch, with 24V button and red illumination
US-B50-HALL	Replacement Push Button , complete US hall Soft Touch, with 24V button and red illumination
US-B50-CAR-HALL-RING	Soft Touch, Car/Hall Ring , vandal proof, aluminum



US-B50-CAR



US-B50-HALL



US-B50-CAR-HALL-RING

Voltage Suppressor

S.E.E.S. #	O.E.M. #	Description
TVS-001	9900640	Voltage Suppressor , 230V



TVS-001

Keys & Keyswitches



TKS-IMR-001H



TKS-IMR-001HR



TKS-001



TKS-002



TKS-77A



TKS-78B



TKS-76A



TKS-77



TKS-78

Fire Service Keyswitch Assemblies

S.E.E.S. #	Description
TKS-IMR-001H	Fire Service , L204 Impulse Series, Round bezel, Horizontal, PH 1, 3 Pos, Rmv 2, (Byp-Off-On)
TKS-IMR-001HR	Fire Service , L204 Impulse Series, Round bezel, Horizontal, PH 1, 3 Pos, Rmv 2, (Reset-Off-On)
TKS-IMR-002H	Fire Service , L204 Impulse Series, Round bezel, Horizontal, PH 2, 3 Pos, Rmv 2, (Off-Hold-On)
TKS-IMS-001H	Fire Service , L204 Impulse Series, Square, Horizontal, PH 1, 3 Pos, Rmv 2, (Byp-Off-On)

Key Switch Assemblies

S.E.E.S. #	O.E.M. #	Description
TKS-001	9714736	Key Switch , Fire Service, PH 1, with L204 Key
TKS-001A		Key Switch , Fire Service, PH 1, with L206 Key, 3 Pos, Rmv 2
TKS-002	9701425	Key Switch , Fire Service, PH 2, with L204 Key
TKS-77A		Key Switch , 2 Pos/Rm 1 Off/On, Moment, L205, Black Round
TKS-77B		Key Switch , 3 Pos/Rm 1 Access Moment, L205, Wired
TKS-77C		Key Switch , 2 Pos/Rm 2 Off/On, L206, Black Round
TKS-78A		Key Switch , 2 Pos/Rm 2 Off/On, L205, Black Round
TKS-78B		Key Switch , 2 Pos/Rm 2 Indep Serv, Off/On, L203, Black Round
TKS-78C		Key Switch , 2 Pos/Rm 2 Run/Stop, L205, Black Round
TKS-80A		Key Switch , Uses L203, 2 Pos Rmv 1, Spring Ret, Off/On, Black Round

Key Switches

S.E.E.S. #	Description
TKS-76A	Key Switch , 2 Pos On/Off, Rmv 2 L206
TKS-77	Key Switch , Uses L205, 2 Pos Rmv 1 Spring Return
TKS-78	Key Switch , Uses L205, 2 Pos Rmv 2
TKS-79	Key Switch , Uses L205, 3 Pos Rmv 1 or Spring Ret Ctr
TKS-80	Key Switch , Uses L203, 2 Pos Rmv 1, Spring Ret

Keys

S.E.E.S. #	O.E.M. #	Description
TK-01		Key, #L201
TK-02		Key, #L202
TK-03	9724310	Key, #L203, hoistway access key
TK-04	9724321	Key, #L204, PH I & II Fire service
TK-05	9724333	Key, #L205, hoistway Run-Stop
TK-06	9724345	Key, #L206, car call key



TK-01



TK-02



TK-03



TK-04



TK-05



TK-06

Cylinder Locks

S.E.E.S. #	O.E.M. #	Description
TKS-73	9856421	Cylinder lock, Uses key L204
TKS-74	9726355	Cylinder lock, Uses key L205
TKS-76	9748531	Cylinder lock, Uses key L206



TKS-73



TKS-74



TKS-76

Door Parts

TAC 50



TDO-01



TDO-01A



TDO-02



TDO-10

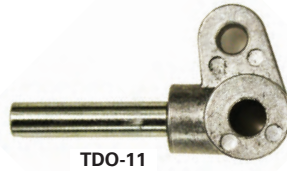

TDO-10D



TDO-11A



TDO-12



TDO-13



TDO-14



TDO-14A



TDO-14B

S.E.E.S. #	O.E.M. #	Description
TDO-01	9817920	Door Motor , R/H 120 VDC 1/6HP encoder & drive pulley assembly
TDO-01A	9716482	Door Motor , L/H 120 VDC 1/6HP Encoder & Drive Pulley assembly
TDO-02	9854058	Motor , Door Operator 1/2HP DC, 115V Double Shaft
TDO-10	9802400	Ball Joint , for Clutch Restrictor, TAC 50
TDO-10D	888AW1	Vane & Restrictor , old 888AN1 & 780CA1
TDO-11	9725461	Restrictor Actuator , TAC 50
TDO-11A	9725461	Restrictor Actuator Kit , for TAC 50 Actuator, Bushing, Bolt and Washers
TDO-12	9852410	Restrictor Slide Bushing , TAC 50
TDO-13	9784695	Finger , Actuating for Restrictor
TDO-14	888AW1	Restrictor Vane , TAC 50, replaces 888AN1 & 780CA1
TDO-14A	9898989	Vane Spring , for Restrictor CI Assembly
TDO-14B	9709287	Vane , for Restrictor Clutch Assembly
TDO-15	9802411	Clutch Restrictor Ball Joint , LH, for TAC 50
TDO-16		Thyssen Landing Door Weight Roller , Nylon 2" Run Dia, 1/4" I.D.
TDO-17		Upthrust Roller , 1-1/8" O.D. 3/8-24 thrd
TDO-18		Angle Hanger Retainer
TDO-19		Kit, Retainer Angle Hatch
TDO-20	9898624	Guide Shoe , with Oil Reserve



TDR-001



TDR-002



TDR-003



TDR-004



TDR-005



TDR-006

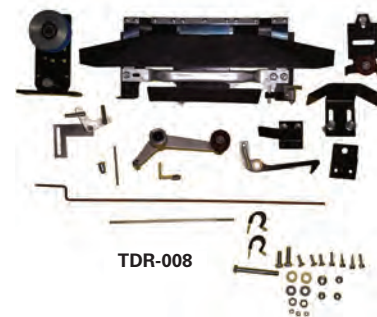

TDR-008

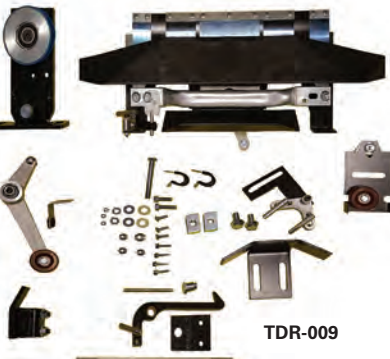

TDR-009



TDR-010



TDR-011



TDR-013



TDR-014



TDR-015



TDR-016



TDR-017

Clutch and Restrictors

S.E.E.S. #	O.E.M. #	Description
TDR-001	9784258	Clutch Restrictor, Kit 2 Speed L.H.
TDR-001A		Timing Relay, 24 VDC DPDT
TDR-002	9805400	Clutch Restrictor, Kit Center Opening
TDR-003	9804640	Clutch Restrictor, Kit Single Speed L.H.
TDR-004	9804651	Clutch Restrictor, Kit Single Speed R.H.
TDR-005	9809570	Clutch Restrictor, Kit 2 Speed R.H.
TDR-006	9809569	Clutch Restrictor, Kit 2 Speed L.H.
TDR-007	9809557	Clutch Restrictor, Kit Center Opening
TDR-008	9809533	Clutch Restrictor, Kit Single Speed L.H.
TDR-009	9809545	Clutch Restrictor, Kit Single Speed R.H.
TDR-010	9800888	Cam, Clutch Actuator (63856, 63891)
TDR-011	9824947	Clutch Kit, Conversion DC62 to HD73, R.H., with hardware
TDR-012	9824935	Clutch Kit, Conversion DC62 to HD73, L.H., with hardware
TDR-013	9739324	Lever Assembly, Actuating Arm L.H.
TDR-013A		Lever Assembly, Actuating Arm R.H.
TDR-014	9739427	Lever, Actuating Arm only R.H.
TDR-015	9739439	Lever, Actuating Arm only L.H.
TDR-016	9723816	Stud, Mounting, for Actuating Arm
TDR-017	9795233	Bracket Assembly, Stop bracket for Restrictor

Door Parts

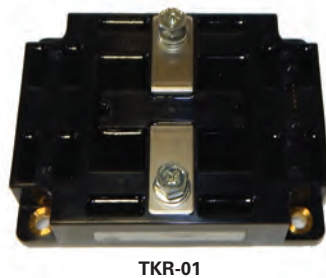
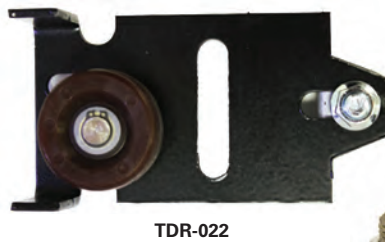
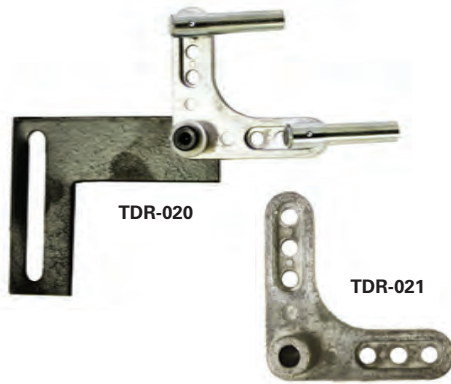

Clutch and Restrictors

S.E.E.S. #	O.E.M. #	Description
TDR-020	9864527	Lever Assembly, Crank for Restrictor
TDR-021	9802415	Lever, Crank for Restrictor
TDR-022	9728159	Bracket Assembly, Stop L.H. for Restrictor
TDR-023	9728640	Bracket Assembly, Stop R.H. for Restrictor
TDR-024	9795233	Bracket Assembly, Stop L.H. with Cover
TDR-025	9812817	Cam, Pick Up Kit, R.H. for Restrictor
TDR-026	9812829	Cam, Pick Up Kit, L.H. for Restrictor
TDR-027	228CC3	Cam, Pickup
TDR-028	166AM1/166AL1	Restrictor Hook, L.H.
TDR-028A	166AM2/166AL2	Restrictor Hook, R.H.
TDR-029	9841265	Bracket Assembly, Hdr Roller Support
TDR-030	196XM1	Bracket, Weldment, Safety Edge Mounting Strip
TDR-031	9824132	Kit, Shoulder Bolt, with Nylon Washers
TDR-032	9824132	Threaded Link Rod For Clutch, Short, 3-5/16"
TDR-032A	9824132	Threaded Link Rod For Clutch, Long, 11-11/16"
TDR-033L	9840941	Door Protective DVC Kit, L.H.
TDR-033R	9840930	Door Protective DVC Kit, R.H.

IGBT Block

S.E.E.S. #	Description
TKR-01	IGBT Block, Tach 50 800A@1200 VAC, 3Phase Gated Rect Block

Printed Circuit Boards

S.E.E.S. #	O.E.M. #	Description
TPC-01	9782849	PCB, for Tach 20 Selector
TPC-001	9782898	PCB, TCID, Hoistway Interconnect
TPC-002	9816410	PCB, Regulator
TPC-003	9875847	PCB, Door, TAC50
TPC-004	9865714	PCB, for CPUA TAC50-04 6300XE1
TPC-006	6300RE3	PCB, IOA Board
TPC-008	6300RD3	PCB, Processor
TPC-009	9816975	PCB, AC/DC 230V, Regulator 6300LR22
TPC-010	9809739	PCB, Car Wiring Assy CWIG
TPC-011	9875523	PCB, Assembly S24-3
TPC-37	9861758	PCB, Emergency Light
TPC-57	9766364	PCB, Assembly Tsmt
TPC-58	9723614	PCB, Sensor Auxiliary
TPC-60	9808103	LON, Talk Adapter Cable-CN
TPC-37A	9754728	Emergency Light Kit PCB, Battery, and Bracket
TPC-37A-BAT	PS-1212	Battery, 12V, 1.4AH, 3.78" L x 1.69" W x 2.04" H
TPC-37B	9809831	Card, Emergency Light Battery Charge
TPC-200	6300VG1, 9857426	PCB, Breakout Board Assembly
THPCB-2		PCB, MF4 6510066680
THPCB-3		PCB, TIA 662000067
THPCB-4		PCB, MB 2.2
THPCB-5		PCB, MF3
THPCB-6		PCB, MS1 B6510004680MS1
THDIS-1		PCB, Display MA9-S
THSS-1		Sensor
TMP-121	6300MK2	PCB Assembly, TAC20 TSA
TPI-001	6300DW1	Position Indicator PCB, Dot Matrix 1" Display



TPC-01



TPC-002



TPC-004



TPC-003



TPC-37



TPC-57

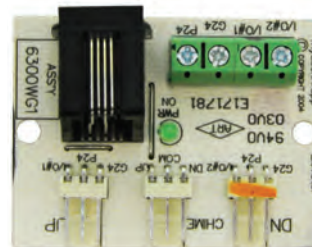

TPC-200



THPCB-2



TPC-006



TPC-009

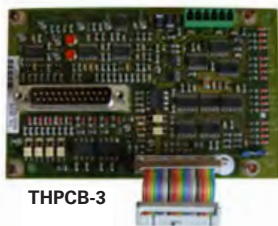

THPCB-3



TPC-008



THPCB-4



THPCB-5



THPCB-6



THDIS-1



TMP-121



Machine Parts



TPAC-23B



TMP-120

Relays



TRP-001



TRP-002



TRP-002A



MIS-901B

Rollers



TW-001



THHR-1



SEES Universal Roller Guides page 492.

Machine Parts

S.E.E.S. #	O.E.M. #	Description
TPAC-23B		Seal Kit, 4S 4-3/8"
TMP-120	9817610	Shaft Encoder, TAC 20, 2048 CPR
TMP-121	6300MK2	TAC20 TSA
TMP-122	9732464/373AX3	Tach Encoder, Shaft Mount
TMP-123		Coupling, Motor/Pump 1.85" O.D. x 1.6" L
TMP-124		Flex Coupling with Split, 1/2" x 3/8"

S.E.E.S. #	O.E.M. #	Description
TRP-001	9782321	Timing Relay, TAC 20 PCB plug DPST, 6A, 24 VDC
TRP-001B		Timing Relay, Tach 20 PCB plug DPST, 5A, 24 VDC
TRP-002	9782333	Relay, Tach 20 PCB plug 110 VDC DPDT
TRP-002A		RC Circuit Module for 110-240 VAC/DC Coil
TRP-002B		Din Rail Screw Terminal (Box Clamp) Socket for 40-44 series relay, 5mm pinning (Blue)
TRP-003		Relay, Tach 20 120 Vac DPDT

Fans

S.E.E.S. #	O.E.M. #	Description
MIS-901B	1512	Exhaust Fan, Low Profile 12" Diameter 5" deep for cab

S.E.E.S. #	O.E.M. #	Description
TW-001	9819745	Roller, Thyssen Counter Weight, 2.625" Diameter, .6693" I.D., 90 Duro
TW-002	650C003	Roller Guide wheel, Thyssenkrupp C.W. 3-1/8" O.D. x 7/8" (80mm x 22mm), .6693" I.D.
TW-003		Thyssen Tach Roller, 6" O.D. x 1.25" W 5/8" Face, Roller Only, No bearing
TW-003A		Thyssen Tach Roller, 6" O.D. x 1.25" W 5/8" Face, with Hub-Shaft and Bearings
TW-004		Thyssen Roller Guide Wheel, 5-7/8" O.D. x 1" W .984" I.D. 6205 Brg, 3/8" Face
TW-004A		Roller Guide Wheel Assembly, 5-7/8" O.D. x 1" W .984" I.D. 6205 Brg, 3/8" Face, with Bolt & Hardware
TW-005		Thyssen Roller Guide Wheel, 3.50" O.D. x 1" W .512" I.D. 6302 Brg, 5/8" Face
TW-005A		Roller Guide Wheel Assembly, 3.50" O.D. x 1" W .512" I.D. 6302 Brg, 5/8" Face, with Bolt & Hardware
THHR-1		Roller, for Door Hanger 70mm x 17mm, bearing 6200 ID:10 GD:62
THHR-2		Roller, for Door Hanger 70mm x 17mm, bearing 6200 ID:10 GD:62
THHR-4	M2TS6-M2TD6	Roller, Door Hanger 67.8mm x 13.7mm 6201 Radius Track, M8x1.25 Thrd
THHR-5	M2TS6-M2TD6	Roller, Door Hanger 41mm x 14mm 6201 Flat Track, M8x1.25 Thrd
THLO-1		Roller, for Door Lock 30mm x 20mm ID:15
THLO-2		Power Lock, with Stop Button



THHR-2



THLO-1

TOSHIBA

QUICK LOCATOR GUIDE

Door Parts	876
Door Lock Assembly	876
Locks	876
Fan	876
Printed Circuit Boards	876
Wheels and Rollers	877
Hanger Rollers	877
Hanger Assemblies	877
Door Vane Roller	877

TOSHIBA

Door Parts

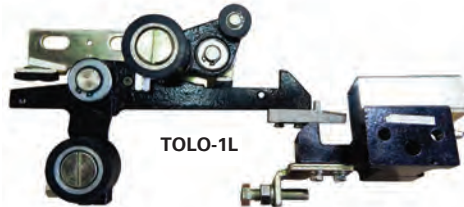

S.E.E.S. #	Description
TOLO-1L	Door Lock Assembly, Toshiba



S.E.E.S. #	Description
TOLO-3	Lock, for Door
TOLO-4	Lock, Triangular



S.E.E.S. #	Description
TOF-1	Fan, FV140 115V, 220V



Printed Circuit Boards

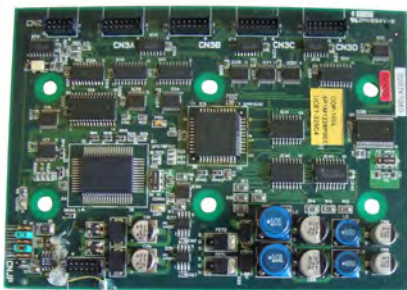

S.E.E.S. #	Description
TOPCB-5	PCB, COP-100L COP For CV180, CV190
TOPCB-8	PCB, HIB-100A SP1M1235-C UCE1-326C3 HOP For CV 180, 5P1M1212P001C
TOPCB-14	PCB, LED-100B For CV180, UCE12-84A2

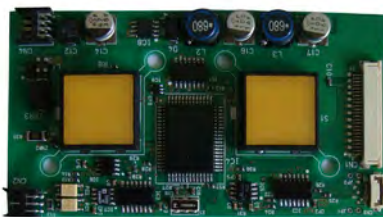

Rollers and Hanger Assemblies

Rollers

S.E.E.S. #	Description
TODV-1	Roller, for CV100, CV190 Door Vane 40mm O.D. x 14mm W, ID:12mm, bearing 6201
TOHR-1	Roller, for Hanger 60mm O.D. x 16mm W, ID:17mm, bearing 6203Z
TOHR-2	Roller, for Hanger 72mm O.D. x 15mm W, ID:15mm, groove dia 64.5mm, bearing 6202
TOHR-3	Roller, for Hanger 60mm O.D. x 12mm W, ID: 10mm, groove dia 44mm, bearing 6200RZ
TOHR-4	Roller, for Hanger 56mm O.D. x 14mm W, ID:12, groove dia 49mm, bearing 6201
TOHR-5	Roller, for Hanger with Eccentric 60mm O.D. x 16mm W, groove dia 52mm, bearing 6203
TOHR-6	Roller, for Hanger Plastic 75mm O.D. x 18mm W, ID:12mm, groove dia 68mm, bearing 6201
TOHR-7	Roller, for Hanger 62mm O.D. x 16mm W, ID:17, groove dia 53mm, bearing 6203
TOHR-8	Roller, Retaining for Hanger 30mm O.D. x 9mm W, 6g-M10
TOLO-1W	Roller, for CV55, CV60 Door Lock 40mm O.D. x 20mm W, ID:18mm
TOLO-2	Roller, for CV100, CV190 Door Lock 40mm O.D. x 14mm W, ID:12, bearing 6201
TOWH-3	Roller, for Hanger Plastic 73mm O.D. x 11mm W, ID:10, bearing 6200
TOWH-4	Roller Assembly, for Hanger Plastic Unit 73mm O.D. x 11mm W

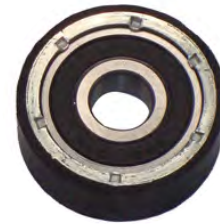

TODV-1



TOHR-1

TOHR-2

TOHR-3

TOHR-4

TOHR-5



TOHR-6

TOHR-7

TOHR-8

TOLO-1W

TOLO-2

TOWH-3

Hanger Assemblies

S.E.E.S. #	Description
TODH-1	Hanger Assembly, for CV100-190 Landing Door
TODH-2	Hanger Assembly, for CV100-190 Landing Door with Screw



TOWH-4



TODH-1



TODH-2



DO IT RIGHT THE FIRST TIME

"THE REQUIREMENTS FOR DOOR RESTRICTORS WAS IMPLEMENTED TO PREVENT PASSENGERS FROM FALLING INTO AN OPEN HOISTWAY UNDERNEATH THE ELEVATOR PLATFORM WHILE TRYING TO EVACUATE FROM AN ELEVATOR THAT IS STUCK BETWEEN FLOORS."

~AMERICAN SOCIETY OF MECHANICAL ENGINEERS

ELECTRICAL vs. MECHANICAL

Requires electric power & battery back up at all times.	vs.	Works even when power is out.
Coils burn up from continuous use.	vs.	Plastic edging protects wires & cables.
Functionality affected by severe temperatures (hot or cold).	vs.	Works in all types of weather conditions.
Required maintenance on plunger, battery, or PC Boards.	vs.	Maintenance Free!
Many false entrapments & call backs.	vs.	No Call Backs!
High Product Costs.	vs.	Lowest cost solution.

SEES RESTRICTOR: THE PREFERRED MECHANICAL DOOR RESTRICTOR



PART# SEES-RESTRICTOR-003
(FLAG SMALL ADJUSTABLE 1.25"-2")

PART# SEES-RESTRICTOR-004
(FLAG LARGE ADJUSTABLE 2"-2.875")



PART# SEES-RESTRICTOR-005
(SHIM KIT w/ HARDWARE)



PART# SEES-RESTRICTOR-006
(FLAG FIXED 1" LENGTH)



PART# SEES-RESTRICTOR-007
(FLAG FIXED 3" LENGTH)



SEES-DWT-001
SEES DOOR
WEDGE TOOL

Always Smooth Sailing



SOUTHERN ELEVATOR
& ELECTRIC SUPPLY



US

QUICK LOCATOR GUIDE

Belts	891
Capacitors	883
Car Signal Components	880-886
Button Assemblies	880-881
Contact Blocks	881
Emergency Stop Switches	881
Gongs	883
Key Switches and Keys	884-885
Lantern and Hall Stations	882
Position Indicator Assemblies	883
Contact Kits	891
Fuses	886
Hatch Equipment	892-893
Door Keys	893
Gibs and Guide Shoe	893
Limit Switches	892
Magnetic Switches	892
Lamps	886
Printed Circuit Boards	887-888
Photo Cell Sensor, Amplifier and Receiver	887
Reverse Phase Amplifier	888
Relays	888-889
Resistors	890
Timers	887-888
Transformers	890
Seals, Packing	891
Selector Tape Guide	893
Starter, Reversing Contactor	888
Valve Kits	891
Wheels and Rollers	894
Roller Guide Assemblies	894

Car Signal Components

US



1
(1-3/8" Wide)

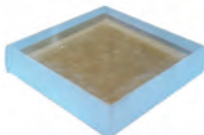
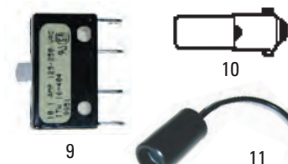

US-B19C



1
(1-3/4" Dia.)

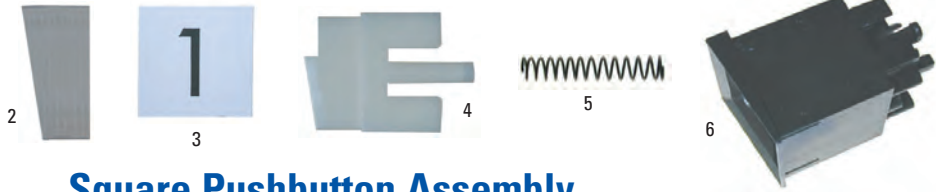
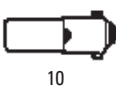

Square Pushbutton Assembly

Item	S.E.E.S. #	O.E.M. #	Description
1	US-B32A-	167-03017-100	Pushbutton assembly complete , square black housing, 167-03010-100 white button insert, specify marking: i.e. US-B32A-Door Open
2	US-B14	467-01006-007	Clear Cap , square plastic button cap
3	US-B23-	467-01012-007	Insert , square white button insert, specify marking i.e. US-B23-Door Open
4	US-B19	467-01005-007	Body , square white molded plastic button body
5	US-B25	920-36001-000	Spring , 1/2" x .088" O.D. x .010" (4 required/assy.)
6	US-B20	467-01001-007	Housing , square black molded plastic button housing
7	US-B22A	167-02014-700	Clamp , pushbutton "L" clamp
8	US-B22B		Clamp , pushbutton "U" clamp
9	US-B26	467-00026-007	Micro switch licon subminiature
10	ML-8	930-27004-000	Lamp , 60 MB, 60 V
11	US-B24	940-31001-000	Lamp socket mini bayonet .575" O.D.
	US-B19C	167-03014-002	Spacer , clear, for square button, to California code

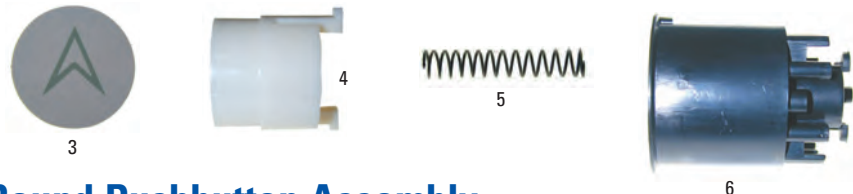

Round Pushbutton Assembly

Item	S.E.E.S. #	O.E.M. #	Description
1	US-B40-	167-03011-100	Pushbutton Assembly complete , round black housing, white button insert, specify marking, i.e. US-B40-Alarm
	US-B40-SPECIAL		Pushbutton Assembly , special engraving
	US-B40- * -ADA		Pushbutton Assembly , round, ADA, California, specify marking, i.e. US-B40-1-ADA
	US-B40-SPECIAL-ADA		Pushbutton Assembly , round, ADA, California, special marking
2	US-B38	467-05006-007	Clear cap , round plastic button cap
3	US-B23A-	467-01012-007	Insert , round white button insert, specify marking i.e. US-B23A-Alarm
4	US-B39	467-05005-007	Body , round white molded plastic button body
	US-B39-SPECIAL		Body , Special Marking for US-B40 Assemblies
	US-B39C	167-03014-001	Spacer , for round button, California code
5	US-B25	920-36001-000	Spring , 1/2" x .088" O.D. x .010" (4 required / assy.)
	US-B25A		Spring , heavy-duty, 1/2" fire service switch, California code
6	US-B37	467-05001-007	Housing , round black molded plastic button housing
7	US-B22A	167-02014-700	Clamp , pushbutton "L" clamp
8	US-B22B		Clamp , pushbutton "U" clamp
9	US-B26	467-00026-007	Microswitch , licon subminiature
10	ML-8	930-27004-000	Lamp , 60 MB, 60V
11	US-B24	940-31001-000	Lamp socket , mini bayonet .575" O.D.

Stop Switches

S.E.E.S. #	O.E.M. #	Description
US-B15A	167-03012-100	Stop Switch Assembly , Square black molded plastic housing with red insert marked "PULL-EMERGENCY-STOP"
US-B15B	167-03013-100	Stop Switch Assembly , Round black molded plastic housing with red insert marked "PULL-EMERGENCY-STOP"
US-B15C	467-05010-007	Button , round, and actuator for stop switch assembly US-B15B
US-B15D	467-05008-007	Mount , for stop switch assembly US-B15B
US-B16	467-01003-007	Housing , Square, black stop switch housing for US-B15A
US-B17	167-02013-700	Arm Actuator Assembly , Includes: Body, Insert and Clear Cap
US-B18	467-00002-007	Toggle Switch , for US-B15A and US-B15B
US-B23-STOP	467-01012-007	Insert for Square Emergency Stop Switch, red insert marked "Pull Emergency Stop"
US-B23A-STOP	467-05012-007	Insert for Round Emergency Stop Switch, red insert marked "Pull Emergency Stop"

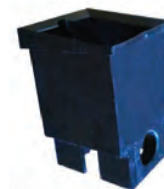

US-B16



US-B18

Contact Blocks

S.E.E.S. #	Description
US-B50C	Contact Block , 110V PB Red Illumination DMG
US-B50F	Contact Block , 24V PB Blue Illumination DMG
US-B50K	Contact Block , 6V PB Red Illumination DMG
US-B50M	Contact Block , 6-120Volt PB Red Illumination DMG



US-B50F



US-B15B



US-B15A

US-B23A-STOP
US-B23-STOP

"Soft Touch" Button

S.E.E.S. #	O.E.M. #	Description
US-B50-BLANK	166-01020-702, 166-10034-100	Button Assembly , Soft Touch Style, 24 VDC if used in series, 48 VDC if used alone, blank
US-PC14	146-05054-300	P.C. Board , for car, used on Soft Touch series
US-PC15	146-05055-300	P.C. Board , for hall, used on Soft Touch series
US-B50-CAR-HALL-RING		Soft Touch Car/Hall Ring , vandal proof, tough metal
US-B50-CAR		Pushbutton Assembly , complete for car
US-B50-CAR-ALARM		Pushbutton Assembly , "Alarm"
US-B50-HALL		Pushbutton Assembly , complete for hall
US-B50-ALARM		Pushbutton Assembly , marked "Alarm"
US-B50-OPEN-DOOR	9991098	US Button Assembly , "Open Door"
US-B50-CLOSE-DOOR	9991086	US Button Assembly , "Close Door"
US-B51	466-00166-001	Soft touch button bezel Rect.
US-B51A		Adapter Kit , for US-B51 key switch mount
US-B51B-SPECIAL		Soft Touch Bezel , Engraved Specify Markings
US-B53-CAR		US Bezel Insert , Car PH2 ON-OFF-FIRE
US-B53-HALL		US Bezel Insert , Hall PH1 BYPASS-OFF-ON-FIRE
US-B53-ALARM		US Bezel Insert , Alarm with bell
US-B53-SPECIAL		US Bezel Insert , Special Specify Marking and Color
US-B53-INDEP		US Bezel Insert , Independent OFF-ON
US-B53-CALL-CANCEL		US Bezel Insert , Call Cancel
US-B53-LIGHT-FAN		US Bezel Insert , LIGHT-FAN LOW-OFF-HIGH
US-B50-SPACER-KIT		Pushbutton Spacer , to adapt old pushbutton to US PC14
US-B53-BLANK-BL		US Bezel Insert , blank, black
MIS-BR1.25-		Braille Plate , #11, 1.25" square, stainless steel, charcoal on black, specify marking

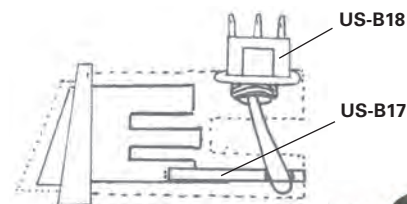

US-B18

US-B17



US-B50-CAR-HALL-RING



US-B51A

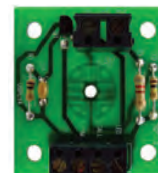

US-PC14

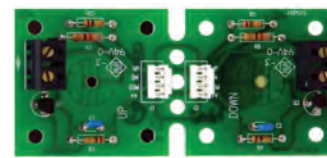

US-PC15



US-B50-BLANK

US-B50-HALL

US-B50-CAR

Car Signal Components



US-B4

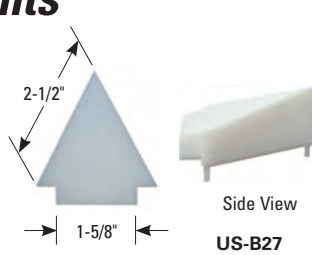

Side View

US-B27

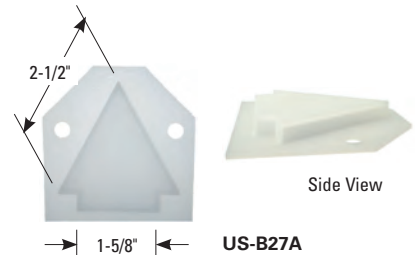

Side View

US-B27A

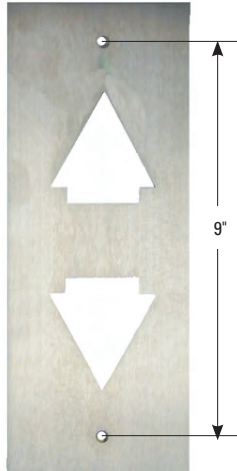

US-B4A

Lantern and Hall Station Plates – Arrows and Diffusers

S.E.E.S. #	O.E.M. #	Description
US-B3	167-30004-107	Lantern plate, Stainless Steel, 4-3/4" x 10-3/4", horizontal for single arrow, terminal floors
US-B3-COVER		Hall Plate Cover, No Arrow Holes, Horiz or Vertical
US-B3C-COVER		Hall Plate Cover, No Arrow Holes, 19.5 x 3.5
US-B4	167-30006-107	Lantern plate, Stainless Steel, 4-3/4" x 10-3/4", horizontal for double arrows, intermediate floors
US-B4A	167-30003-107	Lantern plate, Stainless Steel, 4-3/4" x 10-3/4", vertical for double arrows, intermediate floors
US-B5	167-30002-107	Lantern plate, Stainless Steel, 3-3/4" x 10-3/4", vertical for double arrows, intermediate floors
US-B27	467-00012-007	Arrow, extruded large plastic, 2-1/2" sides, 1-5/8" base, 3 mounting pins on back
US-B27A	467-00028-007	Lens, white flat lantern arrow on plastic mounting base
US-B28	167-03004-700	Diffuser, green, for lantern arrow for US-B27A
US-B29	167-03003-700	Diffuser, red, for lantern arrow for US-B27A



US-B28



US-B29



US-B9



US-B11



US-B12



US-B13

S.E.E.S. # Description

US-B9	Lantern plate, Stainless Steel, 4-3/4" x 10-3/4", Horizontal, Terminal Green
US-B9A	Lantern plate, Stainless Steel, 4-3/4" x 10-3/4", Horizontal, Terminal Red
US-B10	Lantern plate, Stainless Steel, 4-3/4" x 10-3/4", Vertical, Terminal Green
US-B11	Lantern plate, Stainless Steel, 4-3/4" x 10-3/4", Horizontal, Inter. Complete
US-B12	Lantern plate, Stainless Steel, 4-3/4" x 10-3/4", Vertical, Inter. Complete
US-B13	Lantern plate, Stainless Steel, 3-3/4" x 10-3/4", Vertical, Inter. Complete

■ All parts use US-B27.



US-B1A



US-B2



US-B2A

S.E.E.S. # O.E.M. # Description

US-B1	167-61001-107	Hall plate, Stainless Steel, 3" x 7", single square hole, for terminal floors
US-B1A	167-65001-107	Hall plate, Stainless Steel, 3" x 7", single round hole, for terminal floors
US-B2	167-61003-107	Hall plate, Stainless Steel, 3" x 7", double square holes, for intermediate floors
US-B2A	167-65003-107	Hall plate, Stainless Steel, 3" x 7", double round holes, for intermediate floors

Car Signal Components

Position Indicator Assembly

S.E.E.S. #	O.E.M. #	Description
US-B32A-PI*	167-03017-100	Square P.I. assembly, w/ black housing, specify marking
US-B24A	940-31002-000	Socket, .575" O.D. with clip
US-B40-PI*	167-03011-100	Round P.I. Assembly, black housing, specify marking

* Micro switch not used on these assemblies

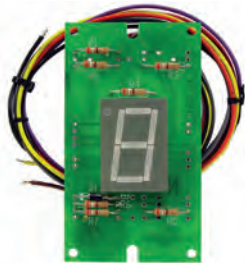

US-PC13G

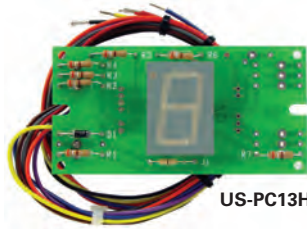

US-PC13H

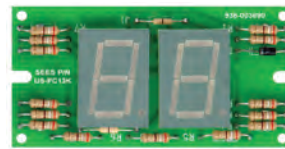

US-PC13K



US-B30

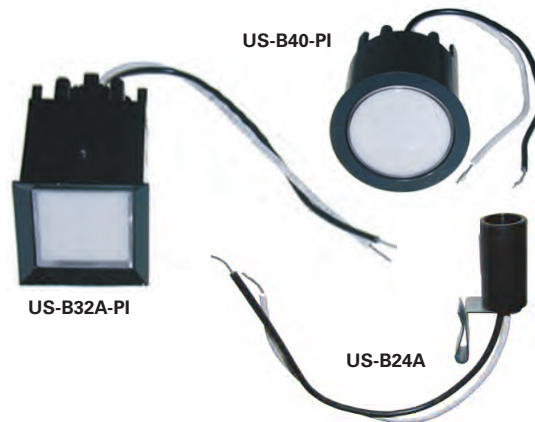

US-B32A-PI

US-B40-PI

US-B24A

Digital Position Indicator Components

S.E.E.S. #	O.E.M. #	Description
US-PC13G	154-05006-301	P.C. board for vertical Digital P.I., single character
US-PC13H	145-05097-301	P.C. board for horizontal Digital P.I., single character
US-PC13J	145-05098-302	P.C. board for vertical Digital P.I., double character
US-PC13K	145-05097-302	P.C. board for horizontal Digital P.I., double character
US-B30	467-00022-007	Black Bezel retainer for Digital Position Indicator
US-B31	467-00020-007	Black Bezel for Digital Position Indicator
US-B31A	467-00021-007	Clear Bezel for Digital Position Indicator
US-B32	167-03005-700	Red Lens for Digital Position Indicator



US-B31



US-B32



US-B8B

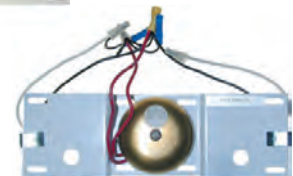

US-B8D



US-B8F

Gongs

S.E.E.S. #	O.E.M. #	Description
US-B8A	167-31002-001	Gong assembly, Horizontal, Single lamp, Relay Controller
US-B8B	167-31003-001	Gong assembly, Horizontal, Double lamp, Relay Controller
US-B8C	167-31002-002	Gong assembly, Horizontal, Single lamp, Microprocessor
US-B8D	167-31003-002	Gong assembly, Horizontal, Double lamp, Microprocessor
US-B8E	167-31000-001	Gong assembly, Vertical, Single lamp, Relay Controller
US-B8G	167-31000-002	Gong assembly, Vertical, Single lamp, Microprocessor
US-B8F	167-31001-001	Gong assembly, Vertical, Double lamp, Relay Controller
US-B8H	167-31001-002	Gong assembly, Vertical, Double lamp, Microprocessor
US-B24A	940-31002-000	Lamp Socket, .5" O.D. with clips, for gongs

Capacitors

S.E.E.S. #	O.E.M. #	Description
US-CAP1	936-50004-000	Capacitor 0.25Mfd, 600V
US-CAP2	936-10032-000	Capacitor 300Mfd, 150V
US-CAP3	936-60022-000	Capacitor 108-130Mfd, 330 VAC
US-CAP3A	936-60022-001	Capacitor 215-260Mfd, 330 VAC
US-CAP4	936-40003-000	Capacitor 320Mfd, 450 VDC
US-CAP5	936-10027-000	Capacitor 150Mfd, 150 VDC
US-CAP6	936-60042-000	Capacitor 5300Mfd, 100 VDC



US-CAP1



US-CAP2



US-CAP3, 3A



US-CAP4, 5, 6

Car Signal Components



US-KS1-HALL



US-KS1-CAR



US-KS1-OFF-ON



US-KS1-OFF-ON-PW



US-KS1-CAR-PW



US-KS1-HALL-PW



US-KS2-HALL



US-KS2-CAR



US-KS2-CAR-PW



US-KS2-2



US-KS2-2PW



US-KS2-3

Key Switches

S.E.E.S. #	O.E.M. #	Description
US-KS1-HALL		Fire Service Phase I , round key switch, BYPASS/OFF/ON, 3 Pos, remove 2, for hall use, BYPASS at 10, OFF at 12, ON at 2, Uses #1 key
US-KS1-CAR		Fire service Phase II , round key switch, OFF/HOLD/ON, 3 Pos, remove 2, for car use, OFF at 10, HOLD at 12, On at 2, Uses #1 key
US-KS1-OFF-ON		Key Switch , round, red, fire service, removable 2 position "OFF-ON", Uses #1 key
US-KS1-OFF-ON-PW		Fire Service Key Switch , Round, Red Key switch OFF, ON, Prewired
US-KS1-CAR-PW		Fire Service , PH1 Rnd Key switch HOLD, OFF, ON, Prewired
US-KS1-HALL-PW		Fire Service , PH1 Rnd Key switch BYPASS, OFF, ON, Prewired
US-KS1-SPECIAL		Fire Service Key Switch , Special #1 Key, Special Engraving
US-KS2-ACCESS		Key Switch , "Access" Off-On 2 Pos Rmv 2, Uses #2 Key
US-KS2-HALL		Fire service Phase I , square key switch, BYPASS at 10, OFF at 12, ON at 2, #1 Key
US-KS2-OFF-ON		Key Switch , Fire Service Red Square 2PR2, Off-On, #1 Key Pre Wired
US-KS2-HALL-PW		Key Switch , Fire Service PH1 Hall Pre Wired
US-KS2-CAR		Fire service Phase II , square key switch, OFF at 10, HOLD at 12, ON at 2, Uses #1 key
US-KS2-CAR-PW		Fire Service Key Switch , PH2 Sq Off - Hold-On, Uses #1 Key, Prewired
US-KS2-2	3199-153	Key Switch , 3 Position Spring Return to center, UP-OFF-DOWN, Uses #2 key
US-KS2-2PW		Key Switch , 3 Position Spring Return to center, Uses #2 key, Prewired
US-KS2-3	D3159-050	Key Switch , 2 Position Spring Return to off, Uses #2 key
US-KS2-3-PW		Key Switch , 2 Position Spring Return to Off, Uses #2 Key, Prewired
US-KS2-5		Key Switch , 3 Position Spring Return To CTR, UP-OFF-DN, Uses #5 Key
US-KS2A		Key , Uses #1 for Fire Service Phase 1 & 2
US-KS2B-ACCESS-PW		Key Switch , "Access" Up/Off/Down 3 Position Spring Return, Uses #2 Key, Wired
US-KS2B		Key , Uses #2 for Hall and Car Access and Inspection
US-KS2C		Key Switch , 3PR3 45° Index, Uses #2 Key
US-KS2B-1	D3158-053L	Key Switch , key switch 2 position, 2 Remove, ON-OFF DPDT, Uses #2 key
US-KS3	167-03046-001	Key Switch , Run/Stop, Black, 2 position round switch to replace stop switch, Uses #3 key



US-KS2-5



US-KS2A



US-KS2C



US-KS3

Key Switches

S.E.E.S. #	O.E.M. #	Description
US-KS3-ACCESS		Key Switch , round, black, Off-On Access 2Pos #3 Key, Pre-Wired
US-KS3-3	3199-153W/US	Key Switch , UP-OFF-DOWN, spring return center Uses # 3 key
US-KS3B		Direction Run Switch , 3 Position UP-OFF-DOWN. Spring return to center (OFF) position. Keyed to Use #3 key
US-KS3B-PW		Key Switch , 3 Position Up-Off-Down Spring Rtn to center, #3 Key, Prewired
US-KS3-R		Key Switch , Run/Stop, Red, 2 position round switch to replace stop switch
US-KS3A		Key , Uses #3 for Light, 1 & 2 Speed Fan, Fan and Light, Door Hold, Run Stop, Hall Park
US-KS3A-INDEP		Key Switch , "Indep Serv" Off-On 2 Pos SEES #3 Key, Square, Black, Pre-Wired
US-KS3-INDEP		Key Switch , "Indep Serv" Off-On 2 Pos #3 Key, Round, Black, Pre-Wired
US-KS3-LIGHT-FAN		Key Switch , "Light-Fan" Off-On 2 Pos #3 Key, Round, Black, Pre-Wired
US-KS3-STOP		Key Switch , "Off-On-Stop" 2 Pos #3 Key, Round, Black, Pre-Wired
US-KS4		Key Switch , Run/Stop, Black, DPDT, removeable both square switch to replace stop switch, Uses #4 key
US-KS-53A		Key Switch Assembly , Run-Stop 2 Pos, Rmv 2, Soft Touch Style
US-KS-53A-2011		Key Switch Assembly , Run-Stop 2 Pos, Rmv 2, H2011 Key
US-KS4-1	D3158-053S	Key Switch , 2 position key switch OFF-ON, Uses # 4 key
US-KS4A		Key , Uses #4 for Ind. Svc., Hospital Emergency, Lockout, Car Park
US-KS4-R		Key Switch , Run/Stop, Red, 2 position square switch to replace stop switch, Uses #3 key
US-KS5A		Key , Uses #5 for Car and Hall Floor Lockout
US-KS5A-LOCKOUT		Lockout Key Switch , Black, Sq Off-On, 2 Pos Remove both #5key
US-KS5-CALL		Call Key Switch , Black, Round OFF-ON, 2 Position spring return, Uses #5 key
US-KS5-LOCKOUT		Lockout Key Switch , Black, Round OFF-ON, 2 Position, Remove 2, Uses #5 key
US-KS6-1		Key Switch , 3 Position, Remove 3, Uses #3 Key, Prewired



Car Signal Components



US-KS1-A



US-KS1-A-ACCESS



US-KS1-A-STOP-RUN



US-KS1-B-OFF-ON



US-KS1-B-CAR



US-KS1-B-HALL



US-KS1-C

Bezels



US-KS1-D-HALL



US-KS1-E



US-KS1-F

S.E.E.S. #	O.E.M. #	Description
US-KS1-A	467-01014-001	Bezel, round black blank, 1-3/4" O.D., raised inner ring 1-9/16" O.D., 3/4" I.D., 2 straight sides
US-KS1-A-ACCESS		Bezel, round, black, Marked Off-On-Access
US-KS1-A-STOP-RUN		Bezel, round black as above, marked "RUN/STOP"
US-KS1-A-OFF-ON		Bezel, round, black, OFF @ 12:00 & ON @ 3:00
US-KS1-B-OFF-ON	M/F US-KS1-B	Bezel, round, red, OFF @ 12:00 & ON @ 3:00
US-KS1-B	467-01014-102	Bezel, round, red blank, 1-3/4" O.D., raised inner ring 1-9/16" O.D., 3/4" I.D., 2 straight sides
US-KS1-B-CAR		Bezel, round red, marked "OFF/HOLD/ON"
US-KS1-B-HALL		Bezel, round red, marked "BYPASS/OFF/ON"
US-KS1-C	467-01015-001	Bezel, square black, blank, 1-5/8" H x 1-7/16" W, raised inner ring 10/16" O.D. with 3/4" I.D. with 2 straight slanted inner sides
US-KS1-D	467-01015-102	Bezel, square red, blank, 1-5/8" H x 1-7/16" W, raised inner ring 10/16" O.D. with 3/4" I.D. with 2 straight inner sides
US-KS1-D-CAR		Bezel, square red marked "OFF/HOLD/ON"
US-KS1-D-HALL		Bezel, square red marked "BYPASS/OFF/ON"
US-KS1-E	467-05022-001	Backing plate, round black 2" O.D. 3/4" I.D., 2 flat outer sides (1-3/4" O.D.)
US-KS1-F		Bezel, square, black, 1-5/8" H x 1-7/16" W, raised inner ring 10/16" O.D. with 3/4" I.D. with 2 straight slanted inner sides marked "RUN/STOP"



F-5SB thru F-32SB



F-17A thru F-26



F-30 thru F-41

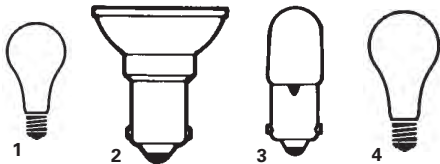

1

2

3

4

Fuses

S.E.E.S. #	O.E.M. #	Description
F-5SB	930-15016-000	Fuse, 0.1 amp, 250V, Slo-Blo
F-12SB	930-15001-000	Fuse, 0.30 amp, 250V, Slo-Blo
F-11SB	930-15020-000	Fuse, 1.25 amp, 250V, Slo-Blo
F-32SB	940-18009-000	Fuse, 5 amp, 125V, Slo-Blo
F-17A	930-15004-000	Fuse, 0.75 amp, 250V
F-19	930-15006-000	Fuse, 2 amp, 250V
F-20	930-15007-000	Fuse, 3 amp, 250V
F-23	930-15009-000	Fuse, 6 amp, 250V
F-26	930-15010-000	Fuse, 10 amp, 250V
F-30	940-18001-000	Fuse, 1 amp, 250V, one-time
F-33	940-18002-000	Fuse, 3 amp, 250V, one-time
F-36	940-18003-000	Fuse, 6 amp, 250V, one-time
F-38	940-18004-000	Fuse, 10 amp, 250V, one-time
F-40	940-18005-500	Fuse, 15 amp, 250V, one-time
F-41	940-18006-000	Fuse, 20 amp, 250V, one-time

Lamps

Fig.	S.E.E.S. #	O.E.M. #	Description
1	ML-8	930-27004-000	Lamp, 60MB, 60V
2	ML-27	930-27007-000	Lamp, 60RB, 60V
3	ML-68	940-24001-000	Lamp, 313, 28V
4	ML-141	940-24004-000	Lamp, 100 A/CL, utility lamp 100W, 230-250V
	US-B24	940-31001-000	Lamp, socket for buttons
	US-B24A	940-31002-000	Lamp, socket for gongs



Printed Circuit Boards and Timers



US-PC4

S.E.E.S. #	O.E.M. #	Description
US-PC4	144-00020-001	Amplifier, Photo Cell Sensor
US-PC5	144-00019-001	Receiver, Photo cell sensor
US-PC5A	144-00018-001	Lamp holder assembly, photo eye, for 60 RB Lamp.
US-PC6	144-00016-001	Hydro Control Board #1
US-PC7	144-00017-001	Hydro Control Board #2



US-PC5



US-PC5A

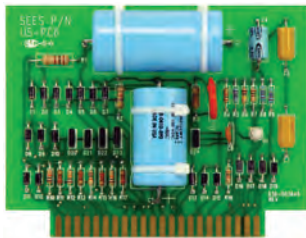

US-PC6

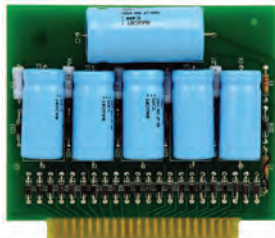

US-PC7

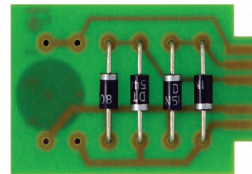

US-PC8

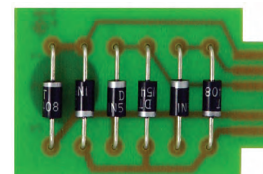

US-PC9

S.E.E.S. #	O.E.M. #	Description
US-PC8	144-00065-001	Rectifier Board
US-PC9	144-00066-001	Rectifier Board
US-PC9B	930-11059-000	Base, for US-PC9 rectifier
US-PC10	144-00035-001	Timer, External Relay .5-5 Sec.
US-PC11	144-00039-001	Timer, External Relay .5-60 Sec.
US-PC12	144-00041-001	Timer, Internal Relay N/O .5-60 Sec
US-PC13	144-00067-001	Timer, Internal Relay N/C .5-60 Sec
US-PC13G	154-05006-301	Position Indicator, PC Board Vertical, Single
US-PC13H	154-05005-301	Position Indicator, PC Board Horizontal, Single



US-PC9B



US-PC10

■ Octal base plug-in timer



US-PC12



US-PC13

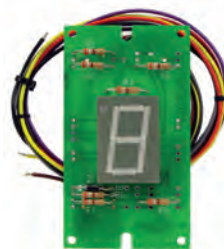

US-PC13G

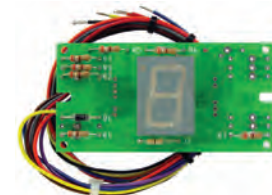

US-PC13H

Printed Circuit Boards and Timers



US-PC10A

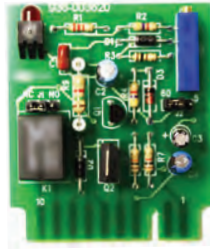

US-PC13A

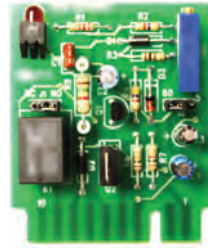

US-PC13B

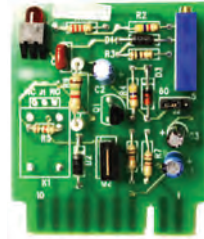

US-PC13F

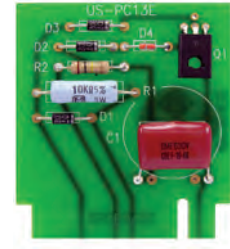

US-PC13E



US-PC13C



US-PC13D



US-PC16



US-PC17



US-PC18



US-PC19



PR-20



AMT-1



AMT-2



AMT-3



AMT-4

Amtech

S.E.E.S. # Description

AMT-1 Omega 1000 Peripheral

AMT-2 Stepper PC Solid State

AMT-3 Level Sensor Decoder

AMT-4 Door Operator Control Board

Relays

S.E.E.S. # O.E.M. # Description

PR-20 930-35029-000 Starter, reversing contactor 3 PDT, 48 VDC

US-R12 930-35030-000 Relay, Type KUP, DPDT, 48 VDC

PR-38 930-35031-000, 930-35032-000 Relay, Flange mount, 3 PDT Type KUP 48 VDC

US-R14 930-35033-000, 930-35033-000 Relay, Flange mount Type KUP 3 PDT 240 VAC

US-R18 930-35053-000 Relay, Plug in Type K10-2P, 48 VDC

Relays

S.E.E.S. #	O.E.M. #	Description
US-R42	930-35051-000, 930-35037-000	Relay, Type R10-4 PDT, 48 VDC
US-R42A	930-37014-000	Base, Socket for 4 PDT, R10-relay
US-R43	930-35052-000	Relay, R10-6 PDT, 48 VDC
US-R43A	930-37015-000	Base, Socket for R10-6 PDT relay
US-R44A	930-02001-000	Base, Socket for R10-4P Latch
US-R44-S		Latching Relay, Solid State 4P 48 VDC
ORP-45	930-35056-000	Relay, VC152A2B-120 VAC
ORP-45A	930-35056-001	Relay, VC153A1B-120 VAC
ORP-45B	930-35056-002	Relay, VC154A-120 VAC

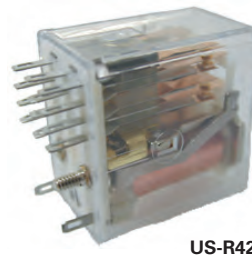

US-R42



US-R43

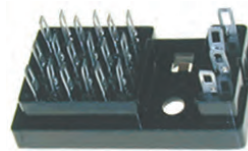

US-R43A



ORP-45

IBM Relays

S.E.E.S. #	O.E.M. #	Description
PR-28-BC	9710322	Clip, bottom hold down clip for relay
PR-28-TC	9710310	Clip, top hold down clip for relay
PR-30	930-35019-000, 769489	Relay, IBM 4 PDT, 48 VDC
PR-30S	769489	Relay, 48 VDC, 4 PDT with LED solid state, alternate to PR-30
PR-33	930-35017-000, 186685	Latching Relay, IBM 4 PDT, 45 VDC
PR-33S		Solid State Replacement for PR-33
PR-35	930-02000-000	Base, for 4 PDT IBM relays
PR-31S	769019	Solid State Replacement for PR-31
PR-35C	930-35018-000	Base, for IBM 6 PDT relay
PR-35E	136267	Arc Suppressor Assy, Diode 3A, 50V for PR-35
PR-34S	769488	Solid State Replacement for PR-34
PR-35D	930-02002-000, 159943	Base, for IBM 12 PDT relay
PR-35A	930-35004-000	Wire Contacts for all IBM Wire Relays
PR-35B		Taper pins for base wiring
PR-35T		Tool, IBM contact removal and insertion tool
PR-35-KIT	9730114	Relay, IBM 4 Pole Base and Top Clip



PR-28-TC



PR-28-BC

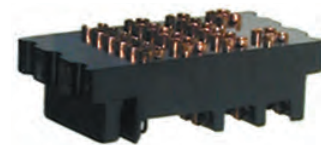

PR-35
IBM Relay Base



PR-31



No. of Contacts	A	B
4 PDT	2"	5/8"
6 PDT	2"	15/16"
12 PDT	2"	1-7/8"

■ Relay Dimensions listed for identification assistance.



PR-35T

■ See page 286 for more IBM sockets and relays.

Tube Base Relays

S.E.E.S. #	O.E.M. #	Description
US-R2	930-35009-000, 930-35012-000	Delay Relay, Amperite, 50V, N.O., 30 sec
US-R3	930-35010-000	Delay Relay, Amperite, 50V, N.O., 5 sec
US-R5	930-35013-000	Delay Relay, Amperite, 50V, N.O., 180 sec
US-R6	930-35015-000	Delay Relay, Amperite, 50V, N.O., 10 sec
US-R7	930-35026-000	Delay Relay, Amperite, 50V, N.O., 8 sec



US-R2



US-R3

Resistors



RES-53 thru RES-61



RES-71

Adjustable Resistor 10-1/2"

S.E.E.S. #	O.E.M. #	Description		
RES-53	934-10055-000	Resistor	10 Ohms	200 Watt
RES-54	934-10054-000	Resistor	25 Ohms	200 Watt
RES-55	934-10063-000	Resistor	50 Ohms	200 Watt
RES-56	934-10057-000	Resistor	100 Ohms	200 Watt
RES-58	934-20206-000	Resistor	200 Ohms	200 Watt
RES-59	934-10056-000	Resistor	250 Ohms	200 Watt
RES-60	934-10062-000	Resistor	500 Ohms	200 Watt
RES-61	934-10060-000	Resistor	1K Ohms	200 Watt

S.E.E.S. #	O.E.M. #	Description		
RES-71	934-10061-000	Resistor	500 Ohms	20W, fixed

Transformers



US-TR1

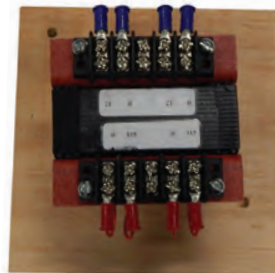

US-TR3



US-TR4



US-TR5



US-TR6



US-TR9

S.E.E.S. #	O.E.M. #	Description	Primary Voltage	Secondary Voltage
US-TR1	940-38001-000	Transformer, 5 VA, for Alarm Bell	120	10
US-TR2	940-38011-000	Transformer, 1.2A	115	6.3
US-TR3	930-45012-000	Transformer, 2-4A	115/230	12/24
US-TR4	940-38012-000	Transformer, 0.25 KVA	200/220/240	55
US-TR5	940-38008-000	Transformer, 0.25 KVA	240/480	120/240
US-TR6	940-38009-000	Transformer, 0.5 KVA	240/480	120/240
US-TR7	940-38010-000	Transformer, 1 KVA	110/120/130	55
US-TR8	940-38007-000	Transformer, 1 KVA	240/480	120/240
US-TR9	940-38004-000	Transformer, 3 KVA	240/480	120/240
US-TR10	448-05001-850	Transformer, 5 A for MDU	200/240	45
US-TR11	448-05004-850	Transformer, 4 A for MDU	220/260	100/100

Seals

Hydraulic Split Seal Stack Packing

S.E.E.S. #	O.E.M. #	Description
USPAC-26	437-00010-000	Packing Set , 4-1/2" x 5 1/2"
USPAC-27	437-00011-000	Packing Set , 5" x 6" x 1-1/2", Split
USPAC-27A	437-00023-000	Packing Set , 5-1/2" x 6-1/2", Split Autopak
USPAC-28	437-00012-000	Packing Set , 6" x 7" x 1/2", Soft Split Autopak
USPAC-29	437-00025-000	Packing Set , 7" x 8" x 1-1/2"
USPAC-30		Seal , worm shaft for #63 Machine



USPAC-26

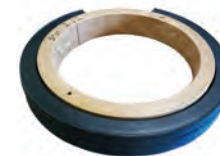

USPAC-27

Valve Kits

S.E.E.S. #	O.E.M. #	Description
MIS-208G	995-00044-001	Repair Kit for UC-1, UC-2, UC-2A
MIS-208G1	995-00044-002	Repair Kit for UC-3A, UC-4



MIS-208G

Pump Belts

S.E.E.S. #	O.E.M. #	Description
MIS-BLT8	990-10105-000	V-Belt 3V375/3VX375
MIS-BLT14	990-10103-000	V-Belt 3V530/3VX530
MIS-BLT15	990-10102-000	V-Belt 3V560/3VX560
MIS-BLT16	990-10101-000	V-Belt 3V600/3VX600
MIS-BLT17	990-10000-000	V-Belt 3V630/3VX630
MIS-BLT17A		V-Belt 3V630
MIS-BLT18	990-10106-000	V-Belt 3V670/3VX670
MIS-BLT19	990-10107-000	V-Belt 3V710/3VX710



MIS-BLT8

Contact Kits

S.E.E.S. #	Description
CKGE-5	Size 1 , Contact Kit, 546-A301G-053, 546-A301G-002
CKGE-7	Size 2 , Contact Kit, 546-A780G-002, 546-A780G-051
CKGE-9	Size 3 , Contact Kit, 55-153677-G001, 55-153677-G002



CKGE-5

Hatch Equipment



MIS-181B



MIS-181B-D



MIS-181H



MIS-181J



US-46



US-46A



US-46B



US-46C

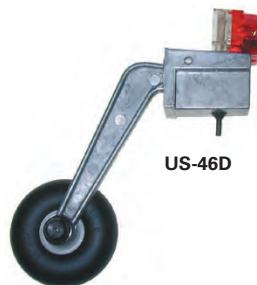

US-46D



US-46F

S.E.E.S. #	O.E.M. #	Description
MIS-181B	930-41014-000	Limit Switch, with roller, 1 N.O., 1 N.C.
MIS-181B-D	LS-1BD	Limit Switch, with Roller, 2 N.O., 2 N.C.
MIS-181H	GLDB03C	Limit Switch, DPDT, Roller Plunger, 10A, 600 VAC, 250 VDC
MIS-181J	534-351	Limit Switch, 534-351 600V 10A NEMA 4/12
MIS-181K	534-351	Limit Switch, Water Tight
MIS-181L		Limit Switch, N.C. Contact
MIS-184A	940-35011-000	Magnetic Switch, 1 N.O., 1 N.C.

Limit Switch

S.E.E.S. #	O.E.M. #	Description
US-46	150-00116-001	Limit Switch assembly, N.C.
US-46A	940-00012-000, 150-00280-001, 150-00142-007	Roller with clip, for Limit Switch US-46
US-46B	940-02004-000	Contact Block assembly, N.C., for limit switch
US-46F	940-02004-001	Contact Block assembly, N.O., for limit switch
US-46C	990-11405-000	Retaining Ring for roller 3/16" shaft
US-46D	150-00643-001	Limit Switch, N.C., new style, with air tire
US-46E	960-00062-000	Roller for limit switch US-46D
US-46T		Tire replacement for US-46A

Guide Assemblies

S.E.E.S. #	O.E.M. #	Description
MIS-119	990-00021-000	Door Key , with collar
MIS-119-P		Door Key , Flapper with Plastic Handle and flexible safety shaft
US-47		Guide Shoe Insert , 5-3/4" long, rounded back, for 8 & 16 lb. rails for assembly #960-00034-000
US-47A		Guide Shoe Insert , 5-3/4" long, slot .64" W x 1" deep, for Model 8ST for assy. #960-00036-000
US-47B		Clip , Replacement Shoe Retainer with Hardware Used on MIS-233
MIS-233		Guide Shoe Assembly , Esco fixed, 5/8" rail with insert
MIS-233B	815DS	Slide Guide Assembly , Double Swivle Self Aligning, 10,000 Lbs Cap, Base 9" x 4 3/4"
MIS-233C	816DS	Slide Guide Assembly , Double Swivle Self Aligning, 10,000 Lbs Cap, Base 5" x 6"
MIS-233F		Guide Shoe Insert , 5-7/8" x 1-11/64 x 63/64, M10 x 1.5
MIS-233H	18FR	Freight Duty Fixed Guide Assembly , For 3/4" Rail
MIS-233J		Guide Shoe Insert , 1-3/8" x 1-3/8" x 9" L for 5/8" Rail
MIS-233K	30SS	Guide Shoe , Freight Duty 1.25" Rail
MIS-233L	16SS	Guide , Slide 20K/Car SS 3x5.5 Mount
US-47C	960-0036-000	Gib Retaining Clips & Hardware , for US-47, 2 required per gib
USDS-001		Door Gib , 7/8" Offset Bracket with 15/32" Gib
USS-001	999-0733	Tape Guide , ASC 2000 Selector



MIS-119



MIS-119-P

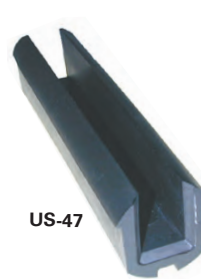

US-47



US-47A



MIS-233

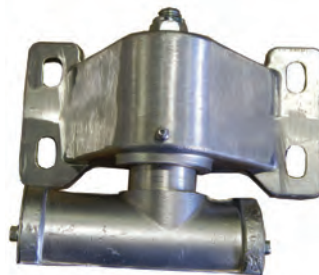

MIS-233B



MIS-233C



US-47B



US-47C

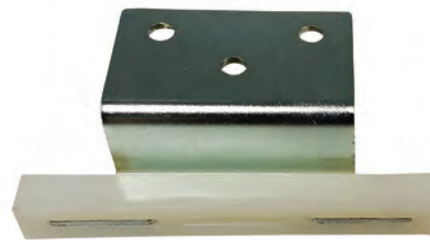

USDS-001



USS-001

Wheels



USW-1



USW-2

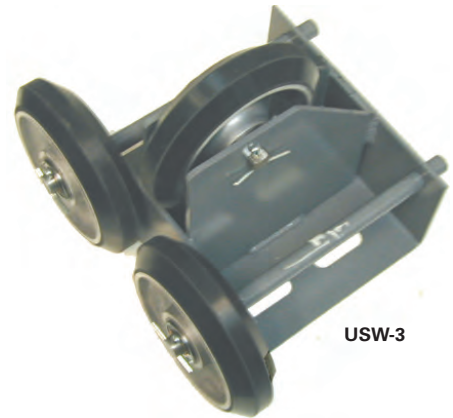

USW-3



USW-4



USW-7

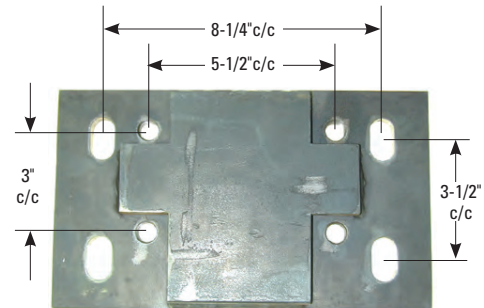

USW-36A

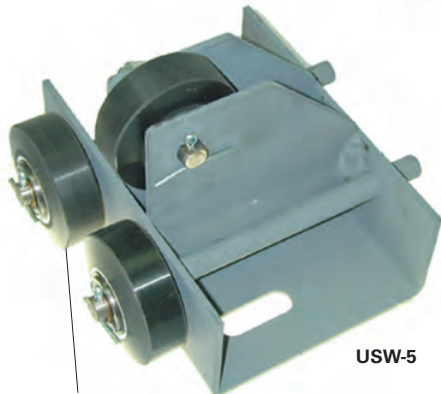

USW-5

USW-4

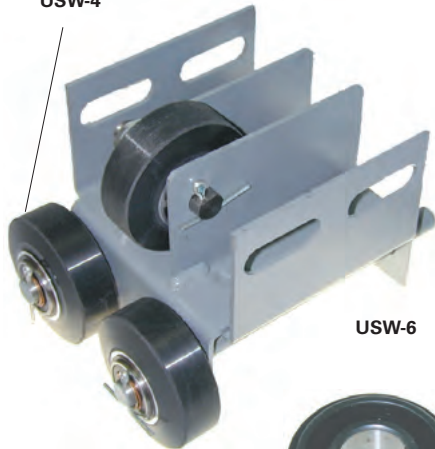

USW-6



USW-8

S.E.E.S. #	O.E.M. #	Description
USW-1	100-00080-001	Roller guide wheel, 6" diameter, polyurethane tire, (5-3/4")
USW-2	100-00054-001	Roller guide assembly for Car, with 6" diameter wheels USW-1. Mounting holes 5-1/2" c/c
USW-3	100-00075-001	Roller guide assembly, 6" dia. Original mounting holes 8-1/4" c/c. Replacement kit consists of USW-2 roller guide assembly and USW-36A adapter
USW-7	100-00100-001, 100-00100-002	Bolt and Bushing Kit for 3" and 6" roller replacement
USW-36A	100-00004-001	Adapter plate for USW-2 when used to replace old style 6" diameter roller guide assembly. Bolt mounting pattern (shown above)
USW-4	114-00009-007	Roller guide wheel, 3-1/4" .625" I.D., tire face 15/16" W, double bearing
USW-5	100-00057-001	Roller guide assembly for Hydro, with 3-1/4" diameter wheels (USW-4)
USW-6	114-00054-001	Roller guide assembly for counterweight, with 3-1/4" diameter wheels (USW-4)
USW-8	960-00011-000	Bearing for governor and roller guide wheels



SEES Universal Roller Guides page 494.



**Color Options & Your Company
Logo Available!**



*Acousti**||**blok®*

Acoustiblok soundproofing option keeps
your submersible tank operating on the **QT**

SEES
Quiet
Tank



Page 349



Page 440



Page 390

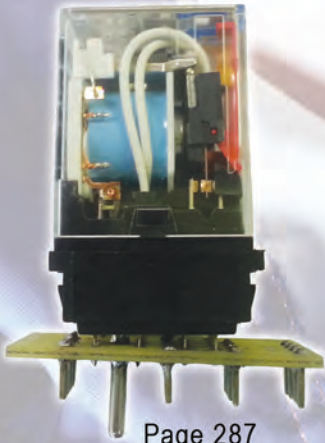

Page 287



**SOUTHERN ELEVATOR
& ELECTRIC SUPPLY**



Page 232

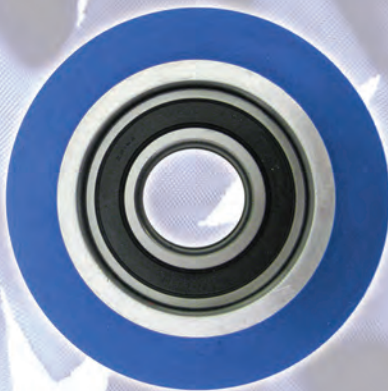

Page 498



Page 313



Page 249

**CAPACITY
2500 LBS**

Page 458



Page 274



Page 310



Page 271



Page 261



Page 250



Page 384



Page 335



Page 102

Page 315



Page 386



Page 477



1.800.526.0026
Tel 954.971.1115
Fax 954.917.7337

1150 W. McNab Rd.
Fort Lauderdale, FL 33309

2781 W. McNab Rd.
Pompano Beach, FL 33069

www.SEEInc.com



**SOUTHERN ELEVATOR
& ELECTRIC SUPPLY**

